

# Engaging the World.

General Catalogue 2013





**Sati** è una realtà importante nella produzione e distribuzione di prodotti per la trasmissione di potenza ad uso industriale. Fondata nel 1974, Sati è diventata leader nel settore coniugando l'esperienza trentennale all'innovazione. Quello che rende unica Sati sono il servizio e la capacità di risposta al cliente. L'ampia gamma di prodotti, la velocità e la puntualità nella consegna sono i nostri punti di forza. Un magazzino organizzato con le più moderne tecnologie gestionali, personale altamente qualificato e multilingue e un sistema di consegna in tempo reale sono i motivi che spingono sempre più clienti a scegliere Sati. Sati fa del rapporto con il cliente il suo valore aggiunto: siamo un'azienda composta da persone che lavorano per dare il miglior servizio al cliente, in qualunque parte del mondo si trovi.



**Sati** is a major player in the production and distribution of power transmission products for industrial use. Founded in 1974, Sati has grown up to the rank of leading company in its sector combining its 30 years experience with innovation. What makes Sati unique are the excellence in service and the uncompromising dedication to customer's needs. Our strength is represented by a wide range of products as well as fast and timely deliveries. In addition to this, a warehouse equipped with the most advanced management technologies, highly qualified multilingual staff and real-time delivery of orders are further reasons why more and more customers decide to give their preference to Sati. Sati makes of its relationship with customers its value added. Our main asset is represented by people who work with one common mission, giving customers the best possible service, wherever in the world they may be.



**Sati** ist ein in der Herstellung und im Vertrieb von Antriebs-elementen für den Industriegebrauch führendes Unternehmen. Durch Innovationsgeist und mehr als dreißig Jahre Erfahrung schuf sich der 1974 gegründete Betrieb eine marktführende Stellung in der Branche. Die Einzigartigkeit von SATI ist durch ihre Dienstleistungsphilosophie und die schnelle und flexible Reaktion auf die Kundenbedürfnisse bestimmt. Eine breite Produktpalette und die schnellen und pünktlichen Lieferungen stellen die Stärke des Unternehmens dar. Dank einem mit hochmodernen Verwaltungstechnologien ausgestatteten Lager, hochqualifiziertem mehrsprachigem Personal und einem Real-Time Liefersystem ziehen mehr und mehr Kunden SATI vor. Und genau aus der Kundenbeziehung haben wir einen Mehrwert geschaffen: Wir arbeiten, um dem Kunden die bestmögliche Dienstleistung anzubieten, egal in welchem Teil der Welt er sich befindet.



**Sati** est une importante société opérant dans la production et distribution de fournitures industrielles dans le domaine de la transmission de puissance. Fondée en 1974, Sati est devenue leader dans son secteur conjuguant son expérience trentenaire avec l'élan continué vers l'innovation. Ce qui rend Sati unique est l'excellence de son service et la capacité de réponse aux clients. Une ample gamme de produits, des livraisons rapides et ponctuelles sont nos points forts. Un stock organisé moyennant les technologies ERP le plus avancées, un personnel très qualifié et plurilingue ainsi qu'un système de livraisons en temps réel sont les atouts qui nous ont fait gagner la préférence de nos clients de plus en plus nombreux. Sati fait de la relation avec les clients sa valeur ajoutée: nous sommes une entreprise composé par des gens qui travaillent avec le but de donner aux clients le meilleur service possible, n'importe où dans le monde il se trouve.



**Sati** es una realidad importante en la fabricación y distribución de productos destinados a la transmisión de potencia para uso industrial. Fundada en 1974, Sati se ha convertido en líder del sector, conjugando su experiencia de más de treinta años y su vocación innovadora. Características distintivas de Sati son el servicio y la capacidad de respuesta al cliente. La amplia gama de productos, la celeridad y la puntualidad en la entrega son nuestros factores identificativos. Un almacén organizado con empleo de las más modernas tecnologías de gestión, personal altamente cualificado y plurilingüe y un sistema de entrega en tiempo real son los motivos que impulsan cada vez a más clientes a elegir Sati. Sati hace de su relación con el cliente su valor adicional: somos una empresa compuesta por personas que trabajan para ofrecer el mejor servicio al cliente, cualquiera que sea la parte del mundo en que se encuentre.



Dall'attenzione di Sati alle richieste del mercato e dal desiderio dell'azienda di distinguersi per offrire ai propri clienti ulteriori servizi è nato Diogene, un sistema di e-commerce avanzato. Le funzionalità di questo software vanno ben oltre il classico carrello della spesa virtuale: Diogene, in accordo con la filosofia di trasparenza e servizio che da sempre contraddistinguono Sati, apre una finestra sul nostro sistema gestionale interno, in tempo reale. Anche in questo caso Sati si è dimostrata lungimirante confermandosi leader nel settore. Diogene permette a tutti i clienti di consultare l'anagrafica degli articoli con i relativi prezzi di listino, di utilizzare potenti funzionalità di ricerca, caricare ordini in tempo reale mediante l'importazione di un file di testo esportato dal vostro gestionale e di avere una stima dei tempi di consegna della merce che si intende ordinare. On line si possono visualizzare le proprie richieste di offerta, i propri ordini in essere e quelli evasi, seguirne in tempo reale lo stato di avanzamento, ristampare le proprie fatture originali, consultare nel dettaglio le proprie spedizioni e anche visualizzare il proprio saldo contabile, analizzando come si compone nel dettaglio.



Strongly focused on the requirements of the market, and motivated by the desire of improving its service performances, Sati has developed Diogene, a leading-edge E-Commerce tool. The functionalities offered by this software are much more sophisticated than the traditional virtual shopping cart: consistent with the philosophy of transparency which has always been integral part of our mission, Diogene opens a window onto our management system in real time. Once more, SATI's forward-thinking attitude confirmed its leadership on the market. Diogene allows all customers to view our product database including relevant list prices by means of powerful search functions, enter orders in real time, even importing files directly from the customer's management system and check the estimated delivery times of the goods required. Furthermore Diogene enables to view inquiries, current and already dispatched orders, track in real time the progress of orders, print original invoices, view the details of shipments as well as the updated statement of account.



Aus der Aufmerksamkeit von SATI für die Marktanfrage und aus ihrem Streben nach einem kompletten Dienstleistungsangebot ist DIOGENE entstanden, ein fortgeschrittenes E-Commerce-System. Diese neue Software bietet viel mehr als den herkömmlichen Warenkorb zum virtuellen Shopping an: DIOGENE, im Einklang mit der Dienstleistungsphilosophie und Transparenzpolitik von SATI, öffnet in Echtzeit ein Fenster auf das Verwaltungssystem des Betriebes. Auch in diesem Fall hat sich die Politik von SATI als weitblickend erwiesen und ihre Rolle als führend auf dem Markt bestätigt. Kunden können die Produktdatenbank einschließlich der jeweiligen Listenpreise abfragen, leistungsfähige Suchfunktionen benutzen, Aufträge durch das Importieren einer aus ihrem Verwaltungssystem exportierten Textdatei eintragen, sowie Informationen über die Lieferzeiten der zu bestellenden Ware bekommen. Darüber hinaus können Kunden durch diesen neuen On-Line-Service ihre eigenen Anfragen und laufende sowie abgeschlossene Aufträge abfragen, deren Ablauf in Echtzeit verfolgen, Original-Rechnungen ausdrucken und laufende Sendungen detailliert prüfen, sowie ihren ausführlichen Rechnungsauszug abfragen.



De l'attention de Sati aux attentes du marché et du désir de la société d'élargir l'offre de ses services a été créé Diogene, un système de commerce électronique avancé avec des performances beaucoup plus sophistiquées par rapport au panier classique des achats virtuels. En harmonie avec la philosophie de service et la politique de transparence qui ont toujours marqué Sati, Diogene ouvre en temps réel une fenêtre sur le système ERP de notre société. Même en ce cas-là Sati a fait preuve de clairvoyance, se confirmant encore une fois le leader dans son secteur. Diogene permet à tous les clients de consulter la banque de données des produits et voir le prix de chaque article grâce à des fonctions de recherche très performantes, d'entrer des commandes en temps réel moyennant l'importation d'un fichier texte exporté du système ERP du client et avoir une idée des délais de livraison de la marchandise qu'on envisage commander. En ligne vous pouvez visualiser vos demandes de prix et délai et vos propres commandes, soit en cours soit déjà livrées, en suivant en temps réel l'état de progression, imprimer à nouveau vos factures en original, consulter en détail vos expéditions et visualiser votre solde comptable détaillé.



De la atención constante prestada por Sati a los requerimientos del mercado y de su voluntad de distinguirse ofreciendo a sus clientes servicios adicionales, ha nacido Diogene, un sistema avanzado de e-commerce. Las funciones de este software superan ampliamente al clásico carrito de la compra virtual: Diogene, en armonía con la filosofía de transparencia y servicio que desde siempre caracteriza a Sati, abre en tiempo real una ventana sobre nuestro sistema interno de gestión. También en este caso Sati ha demostrado su capacidad de anticipar el futuro, confirmandose como líder del sector. Diogene permite a todos los clientes consultar el listado de los artículos disponibles con sus respectivos precios, utilizar potentes funciones de búsqueda, cargar pedidos en tiempo real mediante la importación de un archivo de texto exportado de su programa de gestión y obtener una indicación sobre el plazo de entrega de la mercancía que se desea pedir. En línea es posible visualizar las propias solicitudes de oferta, los propios pedidos ya despachados y aquellos en fase de preparación -verificando en tiempo real su estado de preparación-, reimprimir las propias facturas originales y consultar en detalle los propios envíos, así como visualizar el propio saldo contable, analizando detalladamente su composición.



4

DATI TECNICI INGRANAGGI INDUSTRIALI  
TECHNICAL SPECIFICATIONS  
TECHNISCHE DATEN  
DONNEES TECHNIQUES  
DATOS TECNICOS

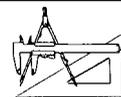

17

SPECIALE STANDARD - SPECIAL STANDARD (Hardened finished bore sprockets)  
SONDER STANDARDTEILE (Gehärtete Kettenräder mit Fertigbohrung)  
STANDARD SPÉCIAL (Pignons trempés prêts à monter)  
ESTÁNDAR ESPECIAL (Piñones templados con agujero mecanizado)



28

PIGNONI - SPROCKETS  
KETTENRÄDER - PIGNONS  
PIÑONES



45

PIGNONI SEMPLICI TEMPERATI AD INDUZIONE SUI DENTI - SIMPLEX SPROCKETS WITH HARDENED TEETH  
GEHÄRTETE EINFACH KETTENRÄDER - PIGNONS SIMPLES AVEC DENTURE TREMPEE HAUTE FREQUENCE  
PIÑONES SIMPLES TEMPLADOS POR INDUCCION EN LOS DIENTES



46

PIGNONI SEMPLICI IN ACCIAIO INOX AISI 304 L  
SIMPLEX SPROCKETS IN STAINLESS-STEEL 304 L  
EINFACH KETTENRÄDER AUS ROSTFREIEM STAHL AISI 304 L  
PIGNONS SIMPLES EN ACIER INOXYDABLE AISI 304 L  
PIÑONES SIMPLES EN ACERO INOXIDABLE AISI 304 L



48

CORONE - PLATE WHEELS  
KETTENRADSCHLEIBEN - DISQUES  
DISCOS



65

CORONE DOPPIE PER DUE CATENE SEMPLICI - DIN 8187 / ISO R606  
DUPLEX PLATEWHEELS FOR TWO SINGLE CHAINS - DIN 8187 / ISO R606  
ZWEIFACH-SCHLEIBEN FÜR ZWEI EINFACH-KETTEN - DIN 8187 / ISO R606  
DISQUES DOUBLES POUR DEUX CHAINES SIMPLES - DIN 8187 / ISO R606  
DISCOS DOBLES PARA DOS CADENAS SIMPLES - DIN 8187 / ISO R606



67

PIGNONI - CORONE ASA  
SPROCKETS - PLATE WHEELS ASA  
KETTENRÄDER - KETTENRADSCHLEIBEN ASA  
PIGNONS - DISQUES ASA  
PIÑONES - DISCOS ASA



80

PIGNONI IN GHISA  
CAST IRON SPROCKETS  
KETTENRÄDER AUS GUSSEISEN  
ROUES EN FONTE  
RUEDA EN FUNDICION

PIGNONI IN GHISA PER BUSSOLA  
TAPER BORED CAST IRON SPROCKETS  
KETTENRÄDER AUS GUSSEISEN FÜR SPANNBUCHSEN  
ROUES EN FONTE À MOYEU AMOVIBLE  
RUEDA EN FUNDICION PARA CASQUILLOS CONICOS



88

CORONE PER TRASPORTATORI ED ELEVATORI  
PLATE WHEELS FOR CHAIN CONVEYORS AND CHAIN ELEVATORS  
KETTENRADSCHLEIBEN FÜR TRANSPORT-UND FÖRDERKETTEN  
DISQUES POUR TRANSPORTEURS ET ELEVATEURS  
DISCOS PARA CADENA DE TRANSPORTADORES Y ELEVADORES



90

RUOTE PER CATENA A CERNIERA  
WHEELS FOR TABLE TOP CHAIN  
KETTENRÄDER FÜR SCHARNIERBANDKETTEN  
ROUES POUR CHAINES À CHARNIÈRES  
RUEDA PARA CADENA DE CHARNELA (TABLE TOP)

PIGNONI TENDICATENA  
BALL BEARING IDLER SPROCKETS  
KETTENSPANNRÄDER  
PIGNONS TENDEURS  
PIÑONES TENSORES



91

PIGNONI PER BUSSOLE CONICHE - TAPER BORED SPROCKETS  
KETTENRÄDER FÜR SPANNBUCHSEN - PIGNONS A MOYEU AMOVIBLE  
PIÑONES PARA CASQUILLOS CÓNICOS



98

MOZZI SALDABILI PER BUSSOLA CONICA - WELDING HUBS FOR TAPER BUSHES  
EINSCHWEISSNABEN FÜR SPANNBUCHSEN - MOYEUX CONIQUES A SOUDER  
CUBOS SOLDADOS PARA CASQUILLOS CÓNICOS



99

BUSSOLE CONICHE - TAPER BUSHES  
SPANNBUCHSEN - MOYEUX AMOVIBLES  
CASQUILLOS CÓNICOS TAPER



103

SISTEMI DI BLOCCAGGIO - SYSTEM BLOCK  
LOCKING DEVICES - SYSTEM BLOCK  
SPANNSÄTZE - SYSTEM BLOCK  
MOYEUX DE SERRAGE - SYSTEM BLOCK  
CASQUILLOS DE FIJACIÓN - SYSTEM BLOCK



122

CREMAGLIERE - SPURGEAR RACKS  
ZAHNSTANGEN - CREMAILLERES  
CREMALLERAS



124

PIGNONI E CORONE A MODULO - SPUR GEARS  
ZÄHNÄDER - ROUES CYLINDRIQUES  
RUEDAS DENTADAS CILINDRICAS



127

COPPIE CONICHE - BEVEL GEAR PAIRS  
KEGELRÄDER - COUPLES CONIQUES  
ENGRANAJES CONICOS



133

CATENA A RULLI - STANDARD CHAIN prodotta da azienda certificata ISO 9001  
ROLLER CHAIN - STANDARD CHAIN manufactured by a company with certification ISO 9001  
ROLLENKETTE - STANDARD CHAIN von einer Firma hergestellt, die ISO 9001 zertifiziert ist  
CHAÎNE À ROULEAUX - STANDARD CHAIN produite par une société certifié ISO 9001  
CADENA DE RODILLOS - STANDARD CHAIN producida por una empresa certificada UNI EN ISO 9001

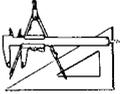
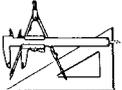

	<p>PULEGGE DENTATE TIMING PULLEYS ZAHNSCHEIBEN POULIES DENTÉES POLEAS DENTADAS</p> <p>DATI TECNICI TECHNICAL SPECIFICATIONS TECHNISCHE DATEN DONNES TECHNIQUES DATOS TECNICOS</p>	<b>147</b>
	<p>PULEGGE PER CINGHIE DENTATE - TIMING BELT PULLEYS ZAHNRIEMENSCHLEIBEN - POULIES POUR COURROIES DENTÉES POLEAS PARA CORREAS DENTADAS</p>	<b>153</b>
	<p>PULEGGE DENTATE PER BUSSOLA CONICA - TIMING BELT PULLEYS FOR TAPER BUSHES ZAHNRIEMENSCHLEIBEN FÜR SPANNBUCHSEN - POULIES DENTÉES A MOYEU AMOVIBLE POLEAS DENTADAS PARA CASQUILLOS CÓNICOS (TAPER)</p>	<b>165</b>
	<p>PULEGGE DENTATE PER CINGHIE PASSO METRICO T - TIMING BELT PULLEYS METRIC PITCH T T ZAHNRIEMENSCHLEIBEN METRISCHE TEILUNG - POULIES DENTÉES POUR COURROIES PAS MÉTRIQUE T POLEAS DENTADAS PARA CORREAS CON PASO METRICO T</p>	<b>173</b>
	<p>PULEGGE PER CINGHIE DENTATE PASSO METRICO ST PER CINGHIE "AT" ST TIMING BELT PULLEYS METRIC PITCH FOR "AT" BELTS ST ZAHNRIEMENSCHLEIBEN METRISCHE TEILUNG FÜR "AT" RIEMEN POULIES DENTÉES ST POUR COURROIES "AT" PAS MÉTRIQUE POLEAS DENTADAS ST PARA CORREAS "AT" CON PASO EN MM</p>	<b>181</b>
	<p>PULEGGE DENTATE PER CINGHIE HTD® - TIMING BELT PULLEYS HTD® HTD® ZAHNRIEMENSCHLEIBEN - POULIES DENTÉES HTD® POLEAS PARA CORREAS DENTADAS HTD®</p>	<b>187</b>
	<p>PULEGGE DENTATE HTD® PER BUSSOLA CONICA - HTD® TIMING BELT PULLEYS FOR TAPER BUSHES HTD® ZAHNRIEMENSCHLEIBEN FÜR SPANNBUCHSEN - POULIES DENTÉES HTD® A MOYEU AMOVIBLE POLEAS DENTADAS HTD® PARA CASQUILLOS CÓNICOS (TAPER)</p>	<b>203</b>
	<p>CINGHIE DENTATE PASSO IN POLLICI - TIMING BELTS IMPERIAL PITCH ZAHNRIEMEN ZOLL TEILUNG - COURROIES DENTÉES PAS EN POUÇES CORREAS DENTADAS PASO EN PULGADAS</p>	<b>211</b>
	<p>CINGHIE PASSO METRICO - TIMING BELTS METRIC PITCH ZAHNRIEMEN METRISCHE TEILUNG - COURROIES PAS MÉTRIQUE CORREAS PASO METRICO</p>	<b>220</b>
	<p>CINGHIE PASSO METRICO "AT" - TIMING BELTS METRIC PITCH "AT" ZAHNRIEMEN METRISCHE TEILUNG "AT" - COURROIES PAS MÉTRIQUE "AT" CORREAS PASO METRICO "AT"</p>	<b>225</b>
	<p>CINGHIE DENTATE HTD® - HTD® TIMING BELTS HTD® ZAHNRIEMEN - COURROIES DENTÉES HTD® CORREAS DENTADAS HTD®</p>	<b>228</b>
	<p>CINGHIE DENTATE A METRAGGIO - TIMING BELTS IN METERS METERWEISE ZAHNRIEMEN - COURROIES DENTÉES A METRAGE CORREAS DENTADAS A METROS</p>	<b>234</b>
	<p>PIASTRE DI BLOCCAGGIO PER CINGHIE - CLAMPING PLATES FOR BELTS KLEMMPLATTEN FÜR ZAHRIEMEN - PLAQUES TENDEUSES POUR COURROIES PLACAS TENSORAS PARA CORREAS</p>	<b>235</b>
	<p>CALCOLO DELLE TRASMISSIONI POSITIVE POSITIVE TRANSMISSION CALCULATION BERECHNUNG DER POSITIVEN ÜBERSETZUNGEN CALCUL DES TRANSMISSIONS POSITIVES CÁLCULO DE LAS TRANSMISIONES POSITIVAS</p> <p>DATI TECNICI TECHNICAL SPECIFICATIONS TECHNISCHE DATEN DONNES TECHNIQUES DATOS TECNICOS</p>	<b>236</b>
	<p>PULEGGE TRAPEZOIDALI PER BUSSOLA CONICA - V-BELT PULLEYS FOR TAPER BUSHES KEILRIEMENSCHLEIBEN FÜR SPANNBUCHSEN - POULIES TRAPÉZOIDALES A MOYEU AMOVIBLE POLEAS TRAPEZOIDALES PARA CASQUILLOS CÓNICOS (TAPER)</p>	<b>259</b>
	<p>PULEGGE TRAPEZOIDALI MONOBLOCCO - V-BELT PULLEYS WITH SOLID HUB KEILRIEMENSCHLEIBEN UNGEBOHRT - POULIES TRAPEZOIDALES MOYEU PLEIN POLEAS TRAPEZOIDALES CON CUBO MACIZO</p>	<b>289</b>
	<p>MOTORI ELETTRICI (Prodotto escluso dal campo di applicazione del Sistema Qualità ISO 9001) ELECTRIC MOTORS (This product is excluded from the scope of ISO 9001 Quality Management System) ELEKTROMOTOREN (Dieses Produkt is vom Anwendungsbereich des Qualitätsmanagementsystems ISO 9001 ausgeschlossen) MOTEURS ÉLECTRIQUES (Ce produit est exclu du domaine d'application du Système de Gestion de la Qualité ISO 9001) MOTORES ELÉCTRICOS (Esto producto está excluido del campo de aplicación del Sistema de Gestión de la Calidad ISO 9001)</p>	<b>301</b>
	<p>ELETTROVENTILATORI (Prodotto escluso dal campo di applicazione del Sistema Qualità ISO 9001) ELECTRIC VENTILATORS (This product is excluded from the scope of ISO 9001 Quality Management System) ELEKTROVENTILATOREN (Dieses Produkt is vom Anwendungsbereich des Qualitätsmanagementsystems ISO 9001 ausgeschlossen) ELECTRO-VENTILATEURS (Ce produit est exclu du domaine d'application du Système de Gestion de la Qualité ISO 9001) ELECTROVENTILADORES (Esto producto está excluido del campo de aplicación del Sistema de Gestión de la Calidad ISO 9001)</p>	<b>311</b>
	<p>PULEGGE VARIABILI - ADJUSTABLE PULLEYS VERSTELLBARE KEILRIEMENSCHLEIBEN POULIES VARIABLES - POLEAS VARIADORAS</p>	<b>313</b>
	<p>SLITTE PER MOTORI - MOTOR SLIDES MOTORSCHLITTEN - GLISSIERES MOTEURS BASES TENSORAS DE MOTORES</p>	<b>316</b>
	<p>GIUNTI DENTATI / TORSIONALI / HRC - TOOTHED / TORSIONAL / HRC COUPLINGS BOGENZAHN / DREHELASTISCHE / HRC KUPPLUNGEN ACCOUPELEMENTS A DENTURE / TORSIONNELS / HRC ACOPLAMIENOTOS DENTADOS / TORSIONALES / HRC</p>	<b>317</b>

Oltre ai prodotti elencati nelle pagine seguenti, la nostra produzione comprende:	In addition to the articles listed in the following pages, our production includes:	Unsere Produktion umfasst zusätzlich zu den auf folgenden Seiten angeführten Ergebnissen auch:	En plus des produits listés dans les pages suivantes, notre production comprend:	Además de los productos citados en las siguientes páginas, nuestra producción incluye:
Dentatura di ingranaggi fino a Ø 3500 mm modulo 30	Toothing for gears up to Ø 3500 mm modul 30	Verzahnung bis Ø 3500 mm Modul 30	Denture d'engrenages jusqu'à Ø 3500 mm, module 30	Dentado de engranajes de hasta 3500 mm Ø módulo 30
Tornitura di pezzi fino ad un diametro di 3000 mm	Turning of workpieces up to a maximum diameter of 3000 mm	Drehbearbeitung bis Ø 3000 mm	Tournage des pièces jusqu'à un diamètre de 3000 mm	Torneado de piezas hasta un diámetro de 3000 mm
Cremafiere a denti diritti ed elicoidali fino a modulo 12 dentatura inclinata fino a 30°	Spur and helical tooth racks up to modul 12, with lead angle up to 30°	Gerad- und schrägverzahnte Zahnstangen bis Modul 12 Steigungswinkel bis 30°	Crémaillères à denture droite et hélicoïdale jusqu'au module 12 Denture inclinée jusqu'à 30°	Cremafiere de dientes rectos y helicoidales hasta el módulo 12, dentado inclinado hasta 30°
Particolari a disegno e dentature non elencate a richiesta	Items according to drawing and toothing not listed can be produced by request	Teile gemäß Zeichnung und Verzahnungen nach Kundenspezifikation	Détails sur plan et dentures non listées, sur demande	Piezas en base a dibujos y dentados especiales, a pedido

Commercializzazione di trasmissioni meccaniche	Commercialisation power transmission drives	Verkauf von mechanischen Getrieben	Commercialisation de transmission mécaniques	Comercialización de transmisiones mecánicas
Motovariatori con riduttori a vite senza fine	Motorized variator with worm gearbox	Getriebemotoren mit Schneckengetrieben	Motovariateurs avec réducteurs à vis sans fin	Variadores de velocidad con reductores de tornillo sinfín
Riduttori a vite senza fine	Wormgearboxes	Schneckengetriebe	Réducteurs à vis sans fin	Reductores de tornillo sinfín
Riduttori coassiali	Helical gearboxes	Stirnradgetriebe	Réducteurs coaxiaux	Reductores coaxiales
Riduttori ad assi ortogonali	Bevel helical gearboxes	Kegelstirnradgetriebe	Réducteurs à axes orthogonaux	Reductores con ejes ortogonales
Riduttori pendolari	Shaft mounted gearboxes	Aufsteckgetriebe	Réducteurs pendulaires (ou flottants)	Reductores pendulares
Motovariatori	Motorized variators	Verstellgetriebemotoren	Motovariateurs	Variadores de velocidad
Rinvio angolare	Bevel gearboxes	Winkelgetriebe	Renvoi d'angle	Transmisiones angulares
Motori elettrici	Electric motors	Elektromotoren	Moteurs électriques	Motores eléctricos
Convertitori di frequenza	Inverters	Frequenzwandler	Convertisseurs de fréquence	Convertidores de frecuencia
Ventilatori industriali e ventole a disegno cliente	Industrial ventilators and fans to drawing	Industrieventilatoren und Lüfter nach Kundenzeichnung	Ventilateurs industriel et hélices sur plan du client	Ventiladores industriales y hélices en base a dibujos, a pedido
Cinghie dentate e trapezoidali	Timing belts and v-belts	Zahn- und Keilriemen	Courroies dentées et trapézoïdales	Correas dentadas y trapecoidales
Pulegge a gola	V-Belt pulleys	Rilenscheiben	Poulies à gorge	Poleas de garganta
Pulegge variabili - Limitatori di coppia	Variable pulleys - Torque limiters	Ausdelmungsriemenscheiben - Drehmomentbegrenzer	Poulies variables - Limiteurs de couple	Poleas variables - limitadores de par
Calettatori	Locking devices	Spannsätze	Moyeux de serrage	Casquillos de fijación
Giunti ed elementi di collegamento	Joints and connection parts	Kupplungen und Verbindungselemente	Joints et éléments de raccordement	Juntas y elementos de conexión
Viti trapezoidali - Chioccioline in acciaio o bronzo	Rolled trapezoidal screws Trapezoidal lead-nuts (bronze or steel)	Trapezschrauben - Stahl - bzw. Bronzemuttern	Vis trapézoïdales - Vis en acier ou en bronze	Tornillos trapecoidales - Espirales de acero o bronce
Supporti orientabili	Pillow blocks	Schwenklager	Supports orientables	Soportes orientables
Catene di trasporto industriale e agricole	Industrial and agricultural conveyor chains	Transportketten für Industrie und Landwirtschaft	Chaînes de transport industriel et agricole	Cadenas de transporte industriales y agrícolas
Giunti cardanici di precisione	Precision joints	Hochpräzise Kardangelenke	Joints de Cardan de précision	Juntas cardánicas de precisión
Profilati e guide di scorrimento in polizene	Polyzene wear strips and slide ways	Profilteile und Polyzen-Führungen	Profilés et glissières en polyzène	Perfiles y guías de deslizamiento en polizeno

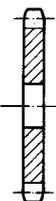
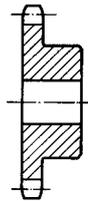
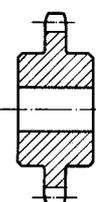
Tipo di ruote dentate	Type of toothed gear	Zahnradtypen	Type de roues dentees	Tipo de ruedas dentadas	
 <p><b>TIPO A</b></p>	<p><b>PUÒ ESSERE:</b></p> <ol style="list-style-type: none"> <li>1) stampato</li> <li>2) con mozzo saldato</li> <li>3) in ghisa</li> </ol>	<p><b>MAY BE:</b></p> <ol style="list-style-type: none"> <li>1) forged</li> <li>2) with welded hub</li> <li>3) made of cast iron</li> </ol>	<p><b>KANN SEIN:</b></p> <ol style="list-style-type: none"> <li>1) formgestanz</li> <li>2) mit geschweißter Nabe</li> <li>3) aus Gußeisen</li> </ol>	<p><b>PEUT ETRE:</b></p> <ol style="list-style-type: none"> <li>1) embouti</li> <li>2) avec moye soudé</li> <li>3) en fonte</li> </ol>	<p><b>PUEDA SER:</b></p> <ol style="list-style-type: none"> <li>1) estampado</li> <li>2) con cubo soldado</li> <li>3) en fundición de hierro</li> </ol>
 <p><b>TIPO B</b></p>					
 <p><b>TIPO C</b></p>	<p><b>PUÒ ESSERE:</b></p> <ol style="list-style-type: none"> <li>1) stampato (simmetrico o asimmetrico)</li> <li>2) con mozzi saldati</li> </ol>	<p><b>MAY BE:</b></p> <ol style="list-style-type: none"> <li>1) forged (symmetrical or asymmetrical)</li> <li>2) with welded hubs</li> </ol>	<p><b>KANN SEIN:</b></p> <ol style="list-style-type: none"> <li>1) formgestanz (symmetrisch oder asymmetrisch)</li> <li>2) mit geschweißten Naben</li> </ol>	<p><b>PEUT ETRE:</b></p> <ol style="list-style-type: none"> <li>1) embouti (symétrique ou asymétrique)</li> <li>2) avec moyeux soudes</li> </ol>	<p><b>PUEDA SER:</b></p> <ol style="list-style-type: none"> <li>1) estampado (simétrico o asimétrico)</li> <li>2) con cubos soldados</li> </ol>

I tipi sopra indicati sono quelli che normalmente sono, i più usati, ciò non toglie che ve ne siano altri la cui forma è dettata da esigenze tecniche di montaggio.

The types given above are those which are most commonly used, but there are, all the same, others whose form depends on technical or assembly requirements.

O.a. Typen sind die üblichsten, es gibt jedoch andere Typen, deren Form von technischen oder Montage-Erfordernissen bedingt sind.

Les types indiqués cidessus sont habituellement employés; il existe cependant d'autres types dont la forme est dictée par les exigences techniques ou de montage.

Los citados tipos son los más frecuentes; sin embargo, hay testar la palabra dos otros cuya forma depende de exigencias técnicas o de montaje.

**Dimensioni delle ruote**

**Dimensions of the wheels**

**Radabmessungen**

**Dimensions des roues**

**Dimensiones de las ruedas**

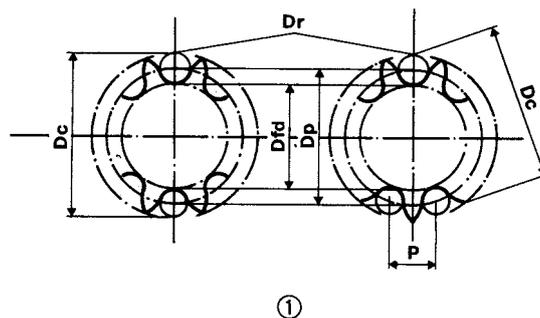

①

Nomenclatura	Nomenclature	Nomenklatur	Nomenclature	Nomenclatura
<b>P</b> = lunghezza del lato del poligono primitivo corrispondente al passo della catena	length of the original polygon corresponding with the chain pitch	Seitenlänge des der Kettenteilung entsprechenden Teilpolygon	longueur du coté du polygone primitif correspondant au pas de la chaîne	longitud del lado del poligono primitivo correspondiente al paso de la cadena
<b>Dr</b> = diametro dei rulli di controllo	diameter of the check rollers	Durchmesser der Kontrollwalzen	diamètre des cylindres de référence	diámetro de los rodillos de control
<b>z</b> = numero dei denti	number of teeth	Zahnanzahl	nombre de dents	numero de dientes
<b>Dp</b> = diametro primitivo	original diameter	Teilkreisdurchmesser	diamètre primitif	diametro primitivo
<b>Dfd</b> = diametro di fondo dente	diameter at tooth base	Fußkreissdurchmesser	diamètre de pied de dent	diametro en la base del diente
<b>Dc</b> = diametro di controllo	check diameter	Kontrolldurchmesser	diamètre de référence	diametro de control

**Dr** = diametro dei rulli di controllo con le seguenti tolleranze: diameter of the check rollers with the following tolerances: Durchmesser der Kontrollwalzen mit folgenden Toleranzen: diamètre des cylindres de reference avec les tolérances suivantes: diámetro de los rodillos de control con las siguientes tolerancias:

$$+ 0$$

$$+ 0,01$$

**Dp** = corrisponde alla circonferenza circoscritta al poligono primitivo in cui i lati sono dati dal passo della catena e il numero dei lati, dal numero dei denti della ruota corresponds with the circumference circumscribed on the original polygon, where sides depend on the chain's pitch. The number of sides depends on the number of teeth on the wheel. Entspricht dem im Teilpolygon umgeschriebenen Kreises, dessen Seiten von der Kettenteilung und dessen Seitenanzahl von der Radzahnanzahl bedingt sind correspond à la circonférence circonscrite au polygone primitif dont les cotés sont donnés par le pas de la chaîne et le nombre des cotés par le nombre des dents de la roue corresponde a la circunferencia circunscrita en el poligono primitivo cuyos lados están dados por el paso de la cadena y el numero de los lados por el número de los dientes de la rueda

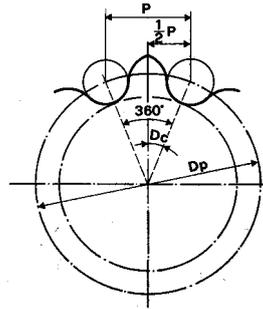

Pertanto il diametro primitivo è dato dalla seguente formula: The original diameter is therefore given by means of the following formula: Der Teildurchmesser läßt sich daher mit folgender Formel berechnen: Donc le diamètre primitif est donné par la formule suivante: Por lo tanto, el diámetro primitivo está dado por la siguiente fórmula:

$$D_p = p \cdot \frac{1}{\sin\left(\frac{180^\circ}{z}\right)} = p \cdot n$$

(Vedere a pagina 11 la tabella dei diametri primitivi unitari in funzione del numero dei denti) (See the table of original diameters as related to the number of teeth on page 11) (Siehe Tabelle der einheitlichen Zahnradmesser je nach Zahnanzahl) (Voir tableau page 11 des diamètres primitifs unitaires en fonction du nombre de dents) (Ver en la página 11 el cuadro de los diámetros primitivos unitarios, en función del número de dientes)

$$D_{fd} = D_p - D_r$$

con le seguenti tolleranze: with the following tolerances: mit folgenden Toleranzwerten: avec les tolérances suivantes: con las siguientes tolerancias:

per diametri a fondo dente / for diam. at base of teeth / für Zahnfußdurchmesser pour diamètres à pied de dent / para diámetros en la base del diente 0  
≤ 127 mm -0,25 mm

per diametri a fondo dente / for diam. at base of teeth / für Zahnfußdurchmesser pour diamètre à pied de dent / para diámetros en la base del diente 0  
> 127 mm -0,30 mm

ma / but / aber / mais / pero ≥ 250 mm

per diametri a fondo dente / for diam. at base of teeth / für Zahnfußdurchmesser pour diamètre à pied de dent / para diámetros en la base del diente > 250 mm toll. ISO h11

**Dc** = per un numero pari di denti / for an even number of teeth / für gerade Zahnanzahl / pour un nombre pair de dents Dp + Dr min

**Dc** = per un numero dispari di denti for an uneven number of teeth / für ungerade Zahnanzahl pour un nombre impair de dents  $D_p \cdot \cos\left(\frac{90^\circ}{z}\right) + D_r \text{ min}$

La misura di controllo Dc di una ruota a numero **pari** di denti è misurata su due rulli situati in due vani diametralmente opposti. The Dc check measurement on a wheel with an **even** number of teeth is measured on two rollers located in two diametrically opposed tooth spaces. Der Kontrollmaß Dc eines Zahnrades mit gerader Zahnanzahl wird auf zwei Rollen in zwei genau entgegengesetzten Räumen gemessen. Der Kontrollmaß Dc eines Zahnrades mit ungerader Zahnanzahl wird auf zwei Rollen in zwei der genau entgegengesetzten Stellen so nahe wie möglich stehenden Räumen gemessen. La mesure de référence Dcd'une roue à nombre **pair** de dents est effectuée sur deux cylindres situés dans deux logements diamétralement opposés. La mesure de référence Dc d'une roue à nombre **impair** de dents est effectuée sur deux cylindres situés dans deux logements les plus proches possible à la position diamétralement opposée. La medida de control Dc de una rueda con número **par** de dientes se mide sobre dos rodillos ubicados en dos cavidades diametralmente opuestas. La medida de control Dc da una rueda con número **impair** de dientes se mide sobre dos rodillos ubicados en dos cavidades lo más cerca posible a la posición diametralmente opuesta.



**Altezza del dente e diametro esterno:      Depth of the teeth and external diameter:      Zahnhöhe und Aussendurchmesser:      Hauteur de la dent et diamètre extérieur:      Altura del diente y diametro externo:**

<p><b>Nomenclatura</b>  <b>At</b> = altezza del dente sopra il poligono primitivo</p> <p><b>De</b> = diametro esterno definito dalla circonferenza che passa per l'estremità dei denti della ruota</p>	<p><b>Nomenclature</b>  depth of the tooth over the original polygon</p> <p>external diameter defined as the circumference measured around the ends of the gear teeth</p>	<p><b>Nomenklatur</b>  Zahnhöhe über dem Teilpolygon</p> <p>Vom Umkreis der Radzahnspitzen definierter Außendurchmesser</p>	<p><b>Nomenclature</b>  hauteur de la dent sur le polygone primitif</p> <p>diamètre extérieur défini à partir de la circonférence qui passe par l'extrémité des dents de la roue</p>	<p><b>Nomenclatura</b>  altura del diente sobre al poligono primitivo</p> <p>diámetro externo definido por la circunferencia que pasa por la extremidad de dos dientes da la rueda</p>
--	---	---	--	--

**Dimensioni      Dimensions      Abmessungen      Dimensions      Dimensiones**

**At max** =  $0,625 p - 0,5 Dr + \frac{0,8 p}{z}$

**At min** =  $0,5 (p - dr)$

**De max** =  $Dp + 1,25 p - Dr$

**De min** =  $Dp + p (1 - \frac{1,6}{z}) - Dr$

**Forma del dente:      Tooth form:      Zahnform:      Forme de la dent:      Forma del diente:**

<p><b>Nomenclatura</b>  <b>p</b> = passo della catena</p> <p><b>Dp</b> = diametro primitivo</p> <p><b>Dr</b> = diametro del rullo della catena</p> <p><b>rf</b> = raggio della curva di riposo del rullo</p> <p><b>a</b> = angolo di contatto del rullo</p> <p><b>Ru</b> = raggio della curva di uscita</p> <p><b>z</b> = numero dei denti della ruota dentata</p>	<p><b>Nomenclature</b>  chain pitch</p> <p>pitch diameter</p> <p>diameter of chain roller</p> <p>radius of roller rest curve</p> <p>contact angle of roller</p> <p>radius of exit curve</p> <p>number of teeth on the toothed gear</p>	<p><b>Nomenklatur</b>  Kettenteilung</p> <p>Teildurchmesser</p> <p>Rollendurchmesser</p> <p>Radius der Rollenruhekurve</p> <p>Rollendruckwinkel</p> <p>Radius der Ausgangskurve</p> <p>Zahnanzahl</p>	<p><b>Nomenclature</b>  pas de la chaîne</p> <p>diamètre primitif</p> <p>diamètre sur le cylindre de la chaîne</p> <p>rayon de la courbe de repos du cylindre</p> <p>angle de contact du cylindre</p> <p>rayon de la courbe de sortie</p> <p>nombre de dents de la roue dentée</p>	<p><b>Nomenclatura</b>  paso de la cadena</p> <p>diámetro primitivo</p> <p>diámetro del rodillo de la cadena</p> <p>radio de la curva de reposo del rodillo</p> <p>ángulo de contacto del rodillo</p> <p>radio de la curva de salida</p> <p>numero de los dientes de la rueda dentada</p>
--	--	---	--	---

**Dimensioni      Dimensions      Abmessungen      Dimensions      Dimensiones**

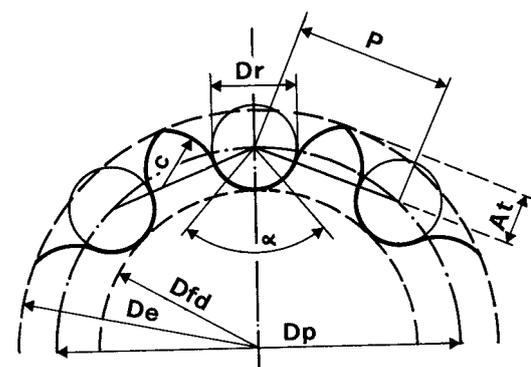

**Profilo minimo / Minimum profilo**  
**Min. Profil / Profil minimum**  
**Perfil mínimo**

**rf** =  $0,505 dr$

**a** =  $140^\circ - \frac{90^\circ}{z}$

**Ru** =  $0,12 dr (z + 2)$

**Profilo massimo / Maximum profilo**  
**Max. Profil / Profil maximum**  
**Perfil máximo**

**rf** =  $0,505 dr + 0,069 \sqrt[3]{dr}$

**a** =  $120^\circ \frac{90^\circ}{z}$

**Ru** =  $0,008 dr (Z_2 + 180)$

Dentatura eseguita con utensili DIN 8196      Gear cutting with DIN 8196 tools      Zahnung mit Werkzeugen nach DIN 8196 ausgeführt      Denture réalisée avec des outils DIN 8196      Dentado realizado con herramientas DIN 8196

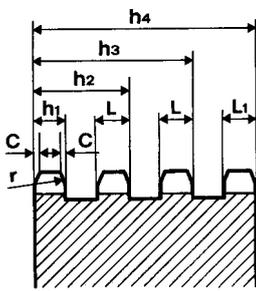
Profilo trasversale della dentatura	Trasverse profile of the toothing	Querschnitt der Verzahnung	Profil transversal de la denture	Perfil transversal de la dentadas	
					
	<b>Nomenclatura</b>	<b>Nomenclature</b>	<b>Nomenklatur</b>	<b>Nomenclature</b>	<b>Nomenclatura</b>
	$h_1$ larghezza dente	tooth width	Zahnbreite	larg. de la dent	ancho del diente
	$h_2, h_3, h_4$ larghezza di ruote doppie, triple, quadruple	width of double, triple and quadruple wheels	Breite von Duplex, Triplex und Quadruplex-Zahnrad	larg. de roues doubles, triples, quadruple	ancho de ruedas dobles, triples, cuadruple
	$r$ raggio dello smusso del dente	bevel range of the tooth	Radius der Zahnschrägkante	rayon de la dépouille de tête	rayo del chaflán del diente
	$C$ larghezza del raggio del dente	width of the tooth radius	Radius der Zahnschräg-kante	largeur du rayoun de tête	anco del rayo del diente
	$p$ passo della catena	chain pitch	Kettenteilung	pas de la chaîne	paso de la cadena
	$TP$ passo trasversale della catena	trasverse chain pitch	Kettenschrägteilung	pas transversal de la chaîne	paso trasversal de la cadena
	$W$ larghezza interna della catena	internal width of the chain	Ketteninnenbreite	largeur interieure de la chaîne	ancho interno de la cadena

Dimensioni	Dimensions	Abmessungen	Dimensions	Dimensiones
				<b><math>p \leq 12,7</math>    <math>p &gt; 12,7</math></b>
$h_1$ per catena semplice / for single chain / für Einfachkette / pour chaîne simple / para cadena simple				= 0,93 W (h 14)    0,95 W (h 14)
$L$ per catena doppia e tripla / for double or triple chain / für Duplex-u.Triplex-Kette / pour chaîne double et triple / para cadena doble y triple				= 0,91 W (h 14)    0,93 W (h 14)
$L_1$ per catena quadrupla e più / for quadruple or more chain / für Quadruplex-Ketten und mehr / pour chaîne quadruple et plus / para cadena cuádruple y supedor				= 0,88 W (h 14)    0,90 W (h 14)
$C =$ da un minimo di 0,1 p ad un massimo di 0,15 p / from a minimum of 0.1 p to a maximum of 0,15 p / von mindestens 0,1 p bis höchstens 0,15 p / d'un minimum de 0,1 p à un maximum de 0,15 p / desde un minimo de 0,1 p hasta un maximo da 0,15 p				

**Numero di denti**  
Le formule suddette sono quelle dettate dalle norme ISO/R 606 e sono valide per ruote dentate per catene a rulli da 9 a 150 denti. Le dentature che si raccomandano sono: 13 - 15 - 17 - 19 - 21 - 23 - 25 - 38 - 57 - 76 - 95 - 114.

**Number of teeth**  
The formulas given above refer to those specified in the ISO/R 606 standards and are valid for toothed gears for roller chains with from 9 to 150 teeth. The recommended toothings are: 13 - 15 - 17 - 19 - 21 - 23 - 25 - 38 - 57 - 76 - 95 - 114.

**Zahnanzahl**  
O.a. Formeln beziehen sich auf die Formeln der ISO/R 606 Vorschriften und gelten für Rollenkettenzahnäder mit 9 bis 150 Zähnen. Wir empfehlen folgende Verzahnungen: 13 - 15 - 17 - 19 - 21 - 23 - 25 - 38 - 57 - 76 - 95 - 114.

**Nombre de dents**  
Les formules présentées ci-dessus se réfèrent à celles indiquées par les normes ISO/R 606 et sont valables pour des roues dentées pour chaînes à cyindres de 9 à 150 dents. Les dentures que nous recommandons sont: 13 - 15 - 17 - 19 - 21 - 23 - 25 - 38 - 57 - 76 - 95 - 114.

**N. de dientes**  
Las citadas fórmulas se refieren a las indicadas por las normas ISO/R 606 y son válidas para ruedas dentadas para cadenas de rodillos de 9 a 150 dientes. Las dentaduras recomendadas son: 13 - 15 - 17 - 19 - 21 - 23 - 25 - 38 - 57 - 76 - 95 - 114.

**Indicazione per ripresa di lavorazione**  
Le ruote sono normalmente fornite con preforo. Si consiglia pertanto, nel caso di ripresa di lavorazione per l'esecuzione dei fori, sedi cuscinetto etc., di fissarle con morsetti dolci sul De in modo tale da ottenere una perfetta concentricità con la dentatura, in quanto l'utensile in fase di dentatura rifinisce anche il De.

**Indications for further machining**  
The wheels are normally supplied with a pilot bore. It is therefore advisable, when machining in order to execute holes, bearing housings etc., to secure them with soft clamps on the external diameter in order to achieve perfect concentricity with the toothing, as during cutting the tool is finishing even outside.

**Anweisungen zum neustart**  
Die Zahnäder werden normalerweise mit Vorbohrung geliefert. Es empfiehlt sich daher, beim Neustart zur Ausführung von Bohrungen, Lagerhalter, usw. die Zahnäder mit Weichklemmen am Außendurchmesser zu befestigen, um eine optimale Konzentrität mit der Verzahnung zu gewährleisten da Während die verzahnung macht das werkzeug auch De.

**Indications pour reusinage**  
Les roues sont livrées avec perçage. On conseille donc, dans le cas d'un réusinage pour l'exécution d'alésages, de sièges palier etc. de les fixer avec des étaux à serrage léger sur le DIA extérieur de façon à obtenir une concentricité parfaite avec la denture car l'outil pendant le taillage usine le De.

**Indicaciones para reiniciar la elaboración**  
Las ruedas se entregan normalmente con un preorificio. En caso de reinicio de la elaboración para la obtención de orificios, sedes para cojinetes, etc., se aconseja fijarlas mediante mordazas suaves sobre el diámetro externo para obtener una perfecta concentricidad con la dentadura.

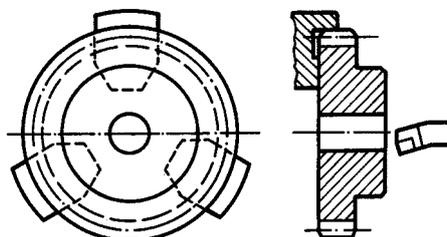

<b>Pezzi prodotti in acciaio C45 E UNI EN 10083-1. Resistenza minima N/mm<sup>2</sup> 600:</b>	<b>Parts produced in C45 E steel UNI EN 10083-1. Minimum strength of 600 N/mm<sup>2</sup>:</b>	<b>Werkstücke aus Stahl C45 E UNI EN 10083-1. Mindestwiderstandsfähigkeit N/mm<sup>2</sup> 600:</b>	<b>Pièces produites en acier C45 E UNI EN 10083-1. Résistance minimum N/mm<sup>2</sup> 600:</b>	<b>Piezas producidas en acero C45 E UNI EN 10083-1 resistencia minima N/mm<sup>2</sup> 600:</b>
Pignoni Sprockets Kettenräder Pignons Pinones	S.D.T. S.D.T. S.D.T. S.D.T. S.D.T. S.D.T. S.D.T. S.D.T. S.D.T. S.D.T. S.D.T. S.D.T. S.D.T. S.D.T. S.D.T.		5 x 2,5 (03) da Z 08 a Z 40 6 x 2,8 (04) da Z 08 a Z 57 1/4 x 1/8 (ASA 25) da Z 08 a Z 40 8 x 3 (05B) da Z 08 a Z 45 3/8 (06B) da Z 08 a Z 40 1/2 x 1/8 (081B) da Z 08 a Z 40 1/2 x 3/16 (083B) da Z 08 a Z 40 1/2 x 1/4 (085B) da Z 08 a Z 40 1/2 x 5/16 (08B) da Z 08 a Z 40 5/8 (10B) da Z 08 a Z 40 3/4 (12B) da Z 08 a Z 40 1"(16B) da Z 08 a Z 30 1"1/4 (20B) da Z 08 a Z 25 1"1/2(24B) da Z 08 a Z 15 1"3/4 (28B) da Z 08 a Z 12 2" (32B) da Z 08 a Z 11	
Pignoni per bussole coniche: Taper bored sprockets: Kettenräder für Spannbuchsen: Pignons a moyeu amovibles: Piñones para casquillos cónicos:	C 45 E UNI EN 10083-1 C 45 E UNI EN 10083-1 C 45 E UNI EN 10083-1 C 45 E UNI EN 10083-1 C 45 E UNI EN 10083-1		Pignoni S.D.T. da Passo 3/8 a Passo 1" 1/4 Sprockets S.D.T. from 3/8 pitch to 1" 1/4 pitch Kettenräder S.D.T. von Teilung 3/8 bis 1" 1/4 Zoll Pignons S.D.T. de pas 3/8 à pas 1" 1/4 Pinones S.D.T. dei paso 3/8 al paso 1" 1/4	
Creomagliere: Spurgear racks: Zahnstangen: Cremailleres: Cremalleras:	C 45 E UNI EN 10083-1 C 45 E UNI EN 10083-1 C 45 E UNI EN 10083-1 C 45 E UNI EN 10083-1 C 45 E UNI EN 10083-1		tutta la produzione whole of production die gesamte Produktion toute la production toda la produccion	
Pignoni e corone a modulo: Spur gears: Zahnräder: Roues cylindriques: Rueda dentadas cilíndricas:	C 45 E UNI EN 10083-1 C 45 E UNI EN 10083-1 C 45 E UNI EN 10083-1 C 45 E UNI EN 10083-1 C 45 E UNI EN 10083-1		tutta la produzione whole of production die gesamte Produktion toute la production toda la produccion	
Coppie coniche: Bevel gear pairs: Kegelräder: Couples coniques: Engranajes cónicos:	C 45 E UNI EN 10083-1 C 45 E UNI EN 10083-1 C 45 E UNI EN 10083-1 C 45 E UNI EN 10083-1 C 45 E UNI EN 10083-1		tutta la produzione whole of production die gesamte Produktion toute la production toda la produccion	

**Pezzi prodotti in acciaio comune. Resistenza minima N/mm<sup>2</sup> 410**

Tutti i prodotti non compresi nella tabella sopra indicata e non compresi fra i prodotti in ghisa.

**Parts produced in standard steel. Minimum strength of 410 N/mm<sup>2</sup>:**

All of the products which are not included in the table above and which are not made from cast iron.

**Werkstücke aus Massenstahl. Mindestwiderstandsfähigkeit N/mm<sup>2</sup> 410:**

Sämtliche von o.a. Tabelle und den Gußeisenteilen ausgeschlossene Produkte.

**Pièces produites en acier commun. Résistance minimum N/mm<sup>2</sup> 410:**

Tous les produits non compris dans le tableau ci-dessus et non compris parmi les produits en fonte.

**Piezas producidas en acero común. Resistencia minima 410 N/mm<sup>2</sup>:**

Todos los productos no incluídos en el citado cuadro ni en los productos en fundición de hierro.

**Pezzi prodotti in Ghisa EN-GJL-200 UNI EN 1561:**

Tutti i prodotti con indicata la specifica GHISA.

**Parts produced in EN-GJL-200 UNI EN 1561 cast iron:**

All of the products that have the specific CAST IRON indication.

**Teile aus Gußeisen EN-GJL-200 UNI EN 1561:**

Sämtliche mit GUSSEISEN gekennzeichnete Produkte.

**Pièces produites en fonte EN-GJL-200 UNI EN 1561:**

Tous les produits avec l'indication spécifique FONTE.

**Piezas producidas en Fundición de hierro EN-GJL-200 UNI EN 1561:**

Todos los productos con la especificación indicada GHISA (fundación de hierro).

**Formula per il calcolo delle ruote per catena**  
**Formula for the calculation of chain wheels**  
**Formel für die berechnung der Zahnkettenräder**  
**Formule pour le calcul des roues de chaînes**  
**Formula para el calculo de las ruedas para cadenas**

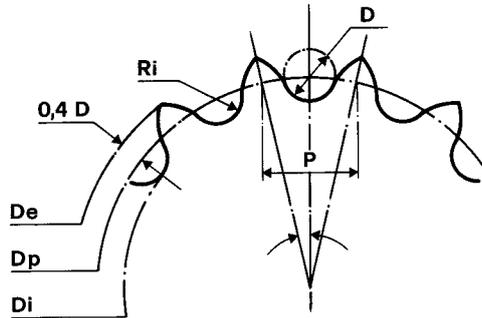

$$De = Dp + (0.8 \cdot D)$$

$$Di = Dp - D$$

$$Ri = 0.54 D$$

$$Dp = \frac{p}{\sin\left(\frac{180^\circ}{z}\right)} = p \cdot \frac{1}{\sin\left(\frac{180^\circ}{z}\right)} = p \cdot n$$

<b>Legenda:</b>	<b>Legend:</b>	<b>Legende:</b>	<b>Legende:</b>	<b>Leyenda:</b>
<b>Z</b> = n. denti ruota	no. wheel teeth	Anzahl Zähne	Nbre de dents roue	n. dientes rueda
<b>p</b> = passo della catena	chain pitch	Zahnkreisteilung der Kette	pas de la chaine	paso de la cadena
<b>D</b> = diametro del rullo	roller diameter	Durchmesser Rolle	diamètre rouleau	diametro rodillo
<b>Ri</b> = raggio incavo	notch radius	Radius Aushöhlung	rayon évidement	rayo cavidad
<b>De</b> = diametro esterno	External diameter	Kopfkreisdurchmesser	diamètre extérieur	diametro externo
<b>Dp</b> = diametro primitivo	Primary diameter	Teilkreisdurchmesser	diamètre primitif	diametro primitivo
<b>Di</b> = diametro interno	Internal diameter	Fusskreisdurchmesser	diamètre intérieur	diametro interno
<b>n</b> = vedi pag. 11	on page 11	Sihe Seite 11	voir page 11	ver en la pagina 11

Il diametro primitivo della ruota (Dp) si ottiene con la formula:

The primary diameter of the wheel (Dp) is obtained with the formula:

Den Teilkreisdurchmesser des Rades (Dp) erhält man mit der Formel:

Le diamètre primitif de la roue (Dp) est obtenu à partir de la formule cidessous:

El diametro primitivo de la rueda (Dp) se obtiene con la formula:

$$Dp = \frac{p}{\sin\left(\frac{180^\circ}{z}\right)}$$

Se in questa formula si sostituisce il valore

Should you change in this formula the value of

Falls man in dieser Formel den Wert

Si, dans cette formule, on remplace la valeur

Si en ésta formula se substituye el valor

$\sin\left(\frac{180^\circ}{z}\right)$  con il valore  $\frac{1}{n}$

$\sin\left(\frac{180^\circ}{z}\right)$  is replaced  $\frac{1}{n}$

$\sin\left(\frac{180^\circ}{z}\right)$  mit dem Wert  $\frac{1}{n}$

$\sin\left(\frac{180^\circ}{z}\right)$  par la valeur  $\frac{1}{n}$

$\sin\left(\frac{180^\circ}{z}\right)$  con el valor  $\frac{1}{n}$

si ottiene:

you have:

ersetzt, erhält man folgendes Resultat:

on a:

se tiene:

$$Dp = \frac{p}{\frac{1}{n}} \text{ oppure/or/oder/ou bien/o sea } Dp = p \cdot n$$

Nella tabella seguente abbiamo raccolto i valori di "n" riferiti ai numeri dei denti più usati, in modo da rendere veloce il calcolo del diametro primitivo.

The following table gives the values of "n" referred to the numbers of teeth used, for a rapid calculation of the primary diameter.

In der nachfolgenden Tafel haben wir die n-Werte zusammengefasst, welche sich auf die gebräuchlichsten Zahnzahlen beziehen, so dass die Berechnung des Teilkreisdurchmessers rasch vorgenommen werden kann.

Sur le tableau suivant, nous avons réuni les valeurs de "n" rapportées aux nombres des dents les plus utilisées de manière à abréger le calcul du diamètre primitif.

En el cuadro siguiente hemos recogido los valores de "n" referidos a los números de los dientes más usados, para calcular rápidamente el diametro primitivo.

**ESEMPIO:**  
Trovare il Dp di una ruota con 20 denti per catena p=12,7; cercare nella tabella il valore "n" corrispondente a 20 denti che è 6,392. Moltiplicando 6,392 x 12,7 avremo mm 81,18 che è il diametro primitivo della ruota scelta.

**EXAMPLE:**  
Find the Dp of a wheel with 20 teeth for a chain with p=12.7; in the table look for the "n" value corresponding to 20 teeth with is 6,392. Moltiply 6,392 x 12.7 gives 81.18 which is the primitive diameter of the wheel chosen.

**BEISPIEL:**  
Den Dp eines Rades mit 20 Zähnen pro Kette und p=12,7 finden; in der Tabelle den n-Wert suchen der 20 Zähnen entspricht, nämlich 6,392. Durch Multiplikation des Wertes 6,392 mit 12.7 erhalten wir 81,18 mm, den Teilkreisdurchmesser des gewählten Zahnkettenrades.

**EXEMPLE:**  
Trouver le Dp d'une roue de 20 dents pour chaîne p=12,7. Chercher sur le tableau la valeur "n" correspondant à 20 dents, soit 6,392. En multipliant 6,392 x 12,7, on obtient 81,18 représentant le diamètre primitif de la roue choisie.

**EJEMPLO:**  
Encontrar el Dp de una rueda con 20 dientes por cadena p=12,7, buscar en el cuadro el valor "n" correspondiente a 20 dientes que es 6,392. Moltiplicando 6,392 x 12,7 tendremos mm 81,18 que es el diametro primitivo de la rueda escogida.

**Tabella dei diametri primitivi unitari in funzione del numero dei denti**

**Table of original diameters related to the number of teeth**

**Tabelle der einheitlichen Teilkreisdurchmesser je nach Zähnezahl**

**Tableau des diamètres primitifs unitaires en fonction du nombre de dents**

**Cuado de los diámetros primitivos unitarios en función del número de dientes**



Z	$\cos\left(\frac{90^\circ}{Z}\right)$	$n = \frac{1}{\sin\left(\frac{180^\circ}{Z}\right)}$	Z	$\cos\left(\frac{90^\circ}{Z}\right)$	$n = \frac{1}{\sin\left(\frac{180^\circ}{Z}\right)}$	Z	$\cos\left(\frac{90^\circ}{Z}\right)$	$n = \frac{1}{\sin\left(\frac{180^\circ}{Z}\right)}$
5	0,95106	1,701						
6		2,000						
7	0,97493	2,305						
8		2,612						
9	0,98481	2,923	57	0,99967	18,152	105	0,99989	33,427
10		3,236	58		18,471	106		33,745
11	0,98982	3,549	59	0,99964	18,789	107	0,99989	34,064
12		3,863	60		19,107	108		34,382
13	0,99271	4,178	61	0,99967	19,425	109	0,99990	34,700
14		4,494	62		19,473	110		35,018
15	0,99452	4,809	63	0,99969	20,061	111	0,99990	35,337
16		5,125	64		20,380	112		35,655
17	0,99575	5,442	65	0,99971	20,698	113	0,99990	35,973
18		5,758	66		21,016	114		36,291
19	0,99658	6,075	67	0,99972	21,334	115	0,99991	36,610
20		6,392	68		21,652	116		36,928
21	0,99720	6,709	69	0,99974	21,971	117	0,99991	37,246
22		7,026	70		22,289	118		37,565
23	0,99767	7,343	71	0,99975	22,607	119	0,99991	37,883
24		7,661	72		22,925	120		38,201
25	0,99803	7,978	73	0,99977	23,243	121	0,99992	38,519
26		8,296	74		23,562	122		38,838
27	0,99831	8,613	75	0,99978	23,880	123	0,99992	39,156
28		8,931	76		24,198	124		39,474
29	0,99853	9,249	77	0,99979	24,516	125	0,99992	39,792
30		9,566	78		24,335	126		40,111
31	0,99876	9,884	79	0,99980	25,153	127	0,99992	40,429
32		10,202	80		25,471	128		40,474
33	0,99880	10,520	81	0,99981	25,789	129	0,99993	41,066
34		10,838	82		26,107	130		41,384
35	0,99899	11,155	83	0,99982	26,426	131	0,99993	41,702
36		11,473	84		26,744	132		42,020
37	0,99913	11,791	85	0,99983	27,062	133	0,99993	42,339
38		12,109	86		27,380	134		42,657
39	0,99919	12,427	87	0,99984	27,699	135	0,99993	42,975
40		12,745	88		28,017	136		43,294
41	0,99927	13,063	89	0,99985	28,335	137	0,99993	43,612
42		13,381	90		28,653	138		43,930
43	0,99931	13,699	91	0,99985	28,971	139	0,99994	44,249
44		14,017	92		29,290	140		44,567
45	0,99939	14,335	93	0,99986	29,608	141	0,99994	44,885
46		14,653	94		29,926	142		45,203
47	0,99944	14,971	95	0,99986	30,244	143	0,99994	45,522
48		15,289	96		30,563	144		45,840
49	0,99949	15,607	97	0,99987	30,881	145	0,99994	46,158
50		15,926	98		31,119	146		46,476
51	0,99953	16,244	99	0,99987	31,518	147	0,99994	46,795
52		16,562	100		31,836	148		47,113
53	0,99957	16,880	101	0,99988	32,154	149	0,99994	47,431
54		17,198	102		32,472	150		47,750
55	0,99959	17,516	103	0,99988	32,791		0,99994	
56		17,834	104		33,109			

TABELLA ESTRATTA DAL **MANUALE DELLA QUALITÀ** Sati SECONDO UNI EN ISO 9001

TABLE EXTRACTED FROM THE **QUALITY MANUAL** Sati ACCORDING TO UNI EN ISO 9001

SISTEMA QUALITA' SPECIFICHE PER IL CONTROLLO DIMENSIONALE		QUALITY SYSTEM DIMENSIONAL CONTROL SPECIFICATIONS		DOC 3AL0202A																																																																	
				Data / Date	Pagina / Page 1/1																																																																
<table border="1"> <tr> <td>Diametro esterno</td> <td>External diameter</td> <td>Außendurchmesser</td> <td>Diamètre externe</td> <td>Diámetro externo</td> <td><b>h14</b></td> </tr> <tr> <td>Diametro di fondo</td> <td>Lower diameter</td> <td>Bodendurchmesser</td> <td>Diamètre de fond</td> <td>Diámetro de fondo</td> <td><b>h11</b></td> </tr> <tr> <td>Diametro rullo</td> <td>Roller diameter</td> <td>Rollendurchmesser</td> <td>Diamètre rouleau</td> <td>Diámetro de rodillo</td> <td><b>+0,01/0</b></td> </tr> <tr> <td>Quota rulli</td> <td>Roller dimension</td> <td>Rollenquote</td> <td>Cote rouleaux</td> <td>Cota de los rodillos</td> <td><b>h11</b></td> </tr> <tr> <td>Quota cordale</td> <td>Chordal dimension</td> <td>Zahnweiteabmaß über einrige Zähne</td> <td>Amplitude cordale</td> <td>Cota cordal</td> <td><b>TAB. 3</b></td> </tr> <tr> <td>Altezza totale</td> <td>Total height</td> <td>Gesamthöhe</td> <td>Hauteur totale</td> <td>Altura total</td> <td><b>TAB. 1</b></td> </tr> <tr> <td>Spessore dente</td> <td>Tooth thickness</td> <td>Zahnstärke</td> <td>Epaisseur dent</td> <td>Espesor diente</td> <td><b>TAB. 2</b></td> </tr> <tr> <td>Preforo</td> <td>Rough hole</td> <td>Vorbereitung</td> <td>Préalésage</td> <td>Pre-agujero</td> <td><b>H12</b></td> </tr> </table>		Diametro esterno	External diameter	Außendurchmesser	Diamètre externe	Diámetro externo	<b>h14</b>	Diametro di fondo	Lower diameter	Bodendurchmesser	Diamètre de fond	Diámetro de fondo	<b>h11</b>	Diametro rullo	Roller diameter	Rollendurchmesser	Diamètre rouleau	Diámetro de rodillo	<b>+0,01/0</b>	Quota rulli	Roller dimension	Rollenquote	Cote rouleaux	Cota de los rodillos	<b>h11</b>	Quota cordale	Chordal dimension	Zahnweiteabmaß über einrige Zähne	Amplitude cordale	Cota cordal	<b>TAB. 3</b>	Altezza totale	Total height	Gesamthöhe	Hauteur totale	Altura total	<b>TAB. 1</b>	Spessore dente	Tooth thickness	Zahnstärke	Epaisseur dent	Espesor diente	<b>TAB. 2</b>	Preforo	Rough hole	Vorbereitung	Préalésage	Pre-agujero	<b>H12</b>																				
Diametro esterno	External diameter	Außendurchmesser	Diamètre externe	Diámetro externo	<b>h14</b>																																																																
Diametro di fondo	Lower diameter	Bodendurchmesser	Diamètre de fond	Diámetro de fondo	<b>h11</b>																																																																
Diametro rullo	Roller diameter	Rollendurchmesser	Diamètre rouleau	Diámetro de rodillo	<b>+0,01/0</b>																																																																
Quota rulli	Roller dimension	Rollenquote	Cote rouleaux	Cota de los rodillos	<b>h11</b>																																																																
Quota cordale	Chordal dimension	Zahnweiteabmaß über einrige Zähne	Amplitude cordale	Cota cordal	<b>TAB. 3</b>																																																																
Altezza totale	Total height	Gesamthöhe	Hauteur totale	Altura total	<b>TAB. 1</b>																																																																
Spessore dente	Tooth thickness	Zahnstärke	Epaisseur dent	Espesor diente	<b>TAB. 2</b>																																																																
Preforo	Rough hole	Vorbereitung	Préalésage	Pre-agujero	<b>H12</b>																																																																
<p><b>TAB. 1 Altezza totale H (valori in mm) rif. DIN 7168 classe F</b></p> <p>Scostamenti limite per campi Maximum permissible deviations Grenzabweichungen nach Toleranz par champs Desviaciones limite para los campos de dimensiones nominali for rated dimension ranges Nennmaßbereichen de cotes nominales de dimensiones nominales</p> <table border="1"> <tr> <td>da 0,5 a 3 from 0,5 to 3</td> <td>da/over 3 a/up to 6</td> <td>da/over 6 a/up to 30</td> <td>da/over 30 a/up to 120</td> <td>da/over 120 a/up to 400</td> <td>da/over 400 a/up to 1000</td> <td>da/over 1000 a/up to 2000</td> <td>da/over 2000 a/up to 4000</td> </tr> <tr> <td>± 0,05</td> <td>± 0,1</td> <td>± 0,15</td> <td>± 0,2</td> <td>± 0,3</td> <td>± 0,5</td> <td>± 0,7</td> <td>± 0,7</td> </tr> </table>		da 0,5 a 3 from 0,5 to 3	da/over 3 a/up to 6	da/over 6 a/up to 30	da/over 30 a/up to 120	da/over 120 a/up to 400	da/over 400 a/up to 1000	da/over 1000 a/up to 2000	da/over 2000 a/up to 4000	± 0,05	± 0,1	± 0,15	± 0,2	± 0,3	± 0,5	± 0,7	± 0,7																																																				
da 0,5 a 3 from 0,5 to 3	da/over 3 a/up to 6	da/over 6 a/up to 30	da/over 30 a/up to 120	da/over 120 a/up to 400	da/over 400 a/up to 1000	da/over 1000 a/up to 2000	da/over 2000 a/up to 4000																																																														
± 0,05	± 0,1	± 0,15	± 0,2	± 0,3	± 0,5	± 0,7	± 0,7																																																														
<p><b>TAB. 2 Spessore dente h o h1 (h2 o h3 vedi catalogo) - Tooth thickness h o h1 (h2 o h3 see catalogue)</b></p> <p>INGRANAGGIO TIPO TYPE OF GEAR</p> <table border="1"> <thead> <tr> <th rowspan="2">INGRANAGGIO TIPO TYPE OF GEAR</th> <th colspan="2">Scostamenti limite per catena tipo</th> <th colspan="4">Maximum permissible deviations for chain type</th> <th colspan="4">Tolerances pour chaîne type</th> <th colspan="2">Desviaciones limite para cadena tipo</th> </tr> <tr> <th>03</th> <th>04</th> <th>05-B</th> <th>06-B</th> <th>08-B</th> <th>10-B</th> <th>12-B</th> <th>16-B</th> <th>20-B</th> <th>24-B</th> <th>MOD.</th> <th>MOD.</th> </tr> </thead> <tbody> <tr> <td>SEMPLICE SINGLE h14</td> <td>0/-0,25</td> <td>0/-0,25</td> <td>0/-0,25</td> <td>0/-0,3</td> <td>0/-0,36</td> <td>0/-0,36</td> <td>0/-0,43</td> <td>0/-0,43</td> <td>0/-0,52</td> <td>0/-0,52</td> <td>MOD.</td> <td>MOD.</td> </tr> <tr> <td>DOPPIO DOUBLE h11</td> <td></td> <td></td> <td>0/-0,09</td> <td>0/-0,11</td> <td>0/-0,13</td> <td>0/-0,13</td> <td>0/-0,16</td> <td>0/-0,16</td> <td>0/-0,19</td> <td>0/-0,19</td> <td>MOD.</td> <td>MOD.</td> </tr> <tr> <td>TRIPLO TRIPLE h11</td> <td></td> <td></td> <td></td> <td>0/-0,13</td> <td>0/-0,16</td> <td>0/-0,16</td> <td>0/-0,19</td> <td>0/-0,19</td> <td>0/-0,22</td> <td>0/-0,25</td> <td>MOD.</td> <td>MOD.</td> </tr> </tbody> </table>		INGRANAGGIO TIPO TYPE OF GEAR	Scostamenti limite per catena tipo		Maximum permissible deviations for chain type				Tolerances pour chaîne type				Desviaciones limite para cadena tipo		03	04	05-B	06-B	08-B	10-B	12-B	16-B	20-B	24-B	MOD.	MOD.	SEMPLICE SINGLE h14	0/-0,25	0/-0,25	0/-0,25	0/-0,3	0/-0,36	0/-0,36	0/-0,43	0/-0,43	0/-0,52	0/-0,52	MOD.	MOD.	DOPPIO DOUBLE h11			0/-0,09	0/-0,11	0/-0,13	0/-0,13	0/-0,16	0/-0,16	0/-0,19	0/-0,19	MOD.	MOD.	TRIPLO TRIPLE h11				0/-0,13	0/-0,16	0/-0,16	0/-0,19	0/-0,19	0/-0,22	0/-0,25	MOD.	MOD.				
INGRANAGGIO TIPO TYPE OF GEAR	Scostamenti limite per catena tipo		Maximum permissible deviations for chain type				Tolerances pour chaîne type				Desviaciones limite para cadena tipo																																																										
	03	04	05-B	06-B	08-B	10-B	12-B	16-B	20-B	24-B	MOD.	MOD.																																																									
SEMPLICE SINGLE h14	0/-0,25	0/-0,25	0/-0,25	0/-0,3	0/-0,36	0/-0,36	0/-0,43	0/-0,43	0/-0,52	0/-0,52	MOD.	MOD.																																																									
DOPPIO DOUBLE h11			0/-0,09	0/-0,11	0/-0,13	0/-0,13	0/-0,16	0/-0,16	0/-0,19	0/-0,19	MOD.	MOD.																																																									
TRIPLO TRIPLE h11				0/-0,13	0/-0,16	0/-0,16	0/-0,19	0/-0,19	0/-0,22	0/-0,25	MOD.	MOD.																																																									
<p><b>TAB. 3 (vedi tab. MC/1) Quote cordali - (see table MC/1) Chordal dimensions</b></p> <p>INGRANAGGIO TIPO TYPE OF GEAR</p> <table border="1"> <thead> <tr> <th rowspan="2">INGRANAGGIO TIPO TYPE OF GEAR</th> <th colspan="2">Scostamenti limite per modulo</th> <th colspan="4">Maximum permissible deviations for modules</th> <th colspan="4">Tolerances limites par module</th> <th colspan="2">Desviaciones limite para módulo</th> </tr> <tr> <th>MOD.</th> <th>MOD.</th> <th>MOD.</th> <th>MOD.</th> <th>MOD.</th> <th>MOD.</th> <th>MOD.</th> <th>MOD.</th> <th>MOD.</th> <th>MOD.</th> <th>MOD.</th> <th>MOD.</th> </tr> </thead> <tbody> <tr> <td>0,75-1-1,25</td> <td>1,50-1,75</td> <td>2-2,25</td> <td>2,50-2,75</td> <td>3-3,25</td> <td>3,50-3,75</td> <td>4-4,25</td> <td>4,50-4,75</td> <td>5-5,25</td> <td>5,50-5,75</td> <td>6</td> <td>MOD.</td> <td>MOD.</td> </tr> <tr> <td>-0,03</td> <td>-0,04</td> <td>-0,05</td> <td>-0,06</td> <td>-0,08</td> <td>-0,09</td> <td>-0,10</td> <td>-0,12</td> <td>-0,13</td> <td>-0,14</td> <td>-0,16</td> <td>MOD.</td> <td>MOD.</td> </tr> <tr> <td>-0,06</td> <td>-0,07</td> <td>-0,08</td> <td>-0,09</td> <td>-0,11</td> <td>-0,12</td> <td>-0,13</td> <td>-0,16</td> <td>-0,17</td> <td>-0,18</td> <td>-0,20</td> <td>MOD.</td> <td>MOD.</td> </tr> </tbody> </table>		INGRANAGGIO TIPO TYPE OF GEAR	Scostamenti limite per modulo		Maximum permissible deviations for modules				Tolerances limites par module				Desviaciones limite para módulo		MOD.	MOD.	MOD.	MOD.	MOD.	MOD.	MOD.	MOD.	MOD.	MOD.	MOD.	MOD.	0,75-1-1,25	1,50-1,75	2-2,25	2,50-2,75	3-3,25	3,50-3,75	4-4,25	4,50-4,75	5-5,25	5,50-5,75	6	MOD.	MOD.	-0,03	-0,04	-0,05	-0,06	-0,08	-0,09	-0,10	-0,12	-0,13	-0,14	-0,16	MOD.	MOD.	-0,06	-0,07	-0,08	-0,09	-0,11	-0,12	-0,13	-0,16	-0,17	-0,18	-0,20	MOD.	MOD.				
INGRANAGGIO TIPO TYPE OF GEAR	Scostamenti limite per modulo		Maximum permissible deviations for modules				Tolerances limites par module				Desviaciones limite para módulo																																																										
	MOD.	MOD.	MOD.	MOD.	MOD.	MOD.	MOD.	MOD.	MOD.	MOD.	MOD.	MOD.																																																									
0,75-1-1,25	1,50-1,75	2-2,25	2,50-2,75	3-3,25	3,50-3,75	4-4,25	4,50-4,75	5-5,25	5,50-5,75	6	MOD.	MOD.																																																									
-0,03	-0,04	-0,05	-0,06	-0,08	-0,09	-0,10	-0,12	-0,13	-0,14	-0,16	MOD.	MOD.																																																									
-0,06	-0,07	-0,08	-0,09	-0,11	-0,12	-0,13	-0,16	-0,17	-0,18	-0,20	MOD.	MOD.																																																									

**Valori per la misurazione dell'ampiezza cordale di dentature ad evolvente per angoli di pressione di 20°**  
**Chordal measurement values of involute teeth for 20° stress angles**  
**Werte für die Messung des Zahnweiteabmaßes zwischen einigen Zähnen von Evolventenverzahnung für Eingriffswinkel von 20°**  
**Valeurs pour le calcul de l'amplitude cordale de dentures à developpante pour angles de pression de 20°**  
**Valores para la amplitud de dentados evolvente para ángulos de presión de 20°**

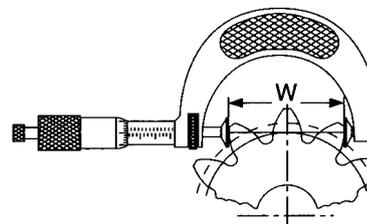

<b>Z</b> = numero di denti del pezzo	number of teeth of piece	Zähnezahl des Teiles	numéro des dents de la pièce	nombre de dientes de la pieza
<b>Z'</b> = numero di denti abbracciati dal calibro	number of teeth in guage	Anzahl der von der Lehre umfaßten Zähne	numéro des dents pincées par le calibre	nombre de dientes abarcados por el calibre
<b>W</b> = ampiezza d'apertura del calibro per modulo 1	opening width of guage for module 1	Öffnungsweite der Lehre für Modul 1	amplitude d'ouverture du calibre pour module 1	abertura del calibre para el módulo 1
<b>N.B.:</b> per moduli superiori a 1 basta moltiplicare il valore W per il modulo	<b>N.B.:</b> for modules in excess of 1, multiply the W value by the module	<b>N.B.:</b> Bei größeren Modulen als 1 braucht nur der Wert W mit dem Modul multipliziert zu werden	<b>N.B.:</b> pour modules supérieurs à 1 il suffit de multiplier la valeur W par le module	<b>N.B.:</b> para módulos superiores a 1 es suficiente multiplicar el valor W por el módulo

es.: mod. 2,5 Z = 52  
W = 16,9650 x 2,5 = 42,4125 mm

**Tab. MC/1**

Z	Z'	W	Z	Z'	W	Z	Z'	W	Z	Z'	W
			51		16,9510	101		35,3641	151		50,8250
			52		16,9650	102		35,3781	152	17	50,8390
			53	6	16,9790	103		35,3921	153		50,8530
			54		16,9930	104	12	35,4061	154		53,8192
			55		19,9591	105		35,4501	155		53,8332
			56		19,9732	106		35,4341	156		53,8472
			57		19,9872	107		35,4481	157		53,8612
			58		20,0012	108		35,4621	158	18	53,8752
			59	7	20,0152	109		38,4282	159		53,8892
			60		20,0292	110		38,4422	160		53,9032
10		4,5683	61		20,0432	111		38,4563	161		53,9172
11		4,5823	62		20,0572	112		38,4703	162		53,9312
12		4,5963	63		20,0712	113	13	38,4843	163		56,8973
13		4,6103	64		23,0373	114		38,4983	164		56,9113
14	2	4,6243	65		23,0513	115		38,5123	165		56,9254
15		4,6383	66		23,0653	116		38,5263	166		56,9394
16		4,6523	67		23,0793	117		38,5403	167	19	56,9534
17		4,6663	68	8	23,0933	118		41,5064	168		56,9674
18		4,6803	69		23,1074	119		41,5205	169		56,9814
19		7,6464	70		23,1214	120		41,5344	170		56,9954
20		7,6604	71		23,1354	121		41,5484	171		57,0094
21		7,6744	72		23,1494	122	14	41,5625	172		59,9755
22		7,6884	73		26,1155	123		41,5765	173		59,9895
23	3	7,7025	74		26,1295	124		41,5905	174		60,0035
24		7,7165	75		26,1435	125		41,6045	175		60,0175
25		7,7305	76		26,1575	126		41,6185	176	20	60,0315
26		7,7445	77	9	26,1715	127		44,5846	177		60,0456
27		7,7585	78		26,1855	128		44,5986	178		60,0596
28		10,7246	79		26,1995	129		44,6126	179		60,0736
29		10,7396	80		26,2135	130		44,6266	180		60,0876
30		10,7526	81		26,2275	131	15	44,6406	181		63,0537
31		10,7666	82		29,1937	132		44,6546	182		63,0677
32	4	10,7806	83		29,2077	133		44,6686	183		63,0917
33		10,7946	84		29,2217	134		44,6826	184		63,0957
34		10,8086	85		29,2357	135		44,6966	185	21	63,1097
35		10,8226	86	10	29,2497	136		47,6628	186		63,1237
36		10,8367	87		29,2637	137		47,6768	187		63,1377
37		13,8089	88		29,2777	138		47,6908	188		63,1517
38		13,8168	89		29,2917	139		47,7048	189		63,1657
39		13,8308	90		29,3057	140	16	47,7189	190		66,1319
40		13,8448	91		32,2719	141		47,7328	191		66,1459
41	5	13,8588	92		32,2859	142		47,7468	192		66,1599
42		13,8728	93		32,2999	143		47,7608	193		66,1738
43		13,8869	94		32,3139	144		47,7748	194	22	66,1879
44		13,9008	95	11	32,3279	145		50,7410	195		66,2019
45		13,9148	96		32,3439	146		50,7550	196		66,2159
46		16,8810	97		32,3559	147	17	50,7690	197		66,2299
47		16,8950	98		32,3699	148		50,7830	198		66,2439
48	6	16,9090	99		32,3839	149		50,7990	199		69,2101
49		16,9230	100	12	35,3500	150		50,8110	200	23	69,2241

**Rapporti di trasmissione / Ratio**

**Untersetzung / Rapport de transmission / Relaciones de transmision**

$$r = \frac{Z_2}{Z_1}$$

Z <sub>2</sub>	Z <sub>1</sub>																
Z <sub>2</sub>	8	9	10	11	12	13	14	15	16	17	18	19	20	21	22	23	24
8	1,00	0,89	0,80	0,73	0,67	0,62	0,57	0,53	0,50	0,47	0,44	0,42	0,40	0,38	0,36	0,35	0,33
9	1,13	1,00	0,90	0,82	0,75	0,69	0,64	0,60	0,56	0,53	0,50	0,47	0,45	0,43	0,41	0,39	0,38
10	1,25	1,11	1,00	0,91	0,83	0,77	0,71	0,67	0,63	0,59	0,56	0,53	0,50	0,48	0,45	0,43	0,42
11	1,38	1,22	1,10	1,00	0,92	0,85	0,79	0,73	0,69	0,65	0,61	0,58	0,55	0,52	0,50	0,48	0,46
12	1,50	1,33	1,20	1,09	1,00	0,92	0,86	0,80	0,75	0,71	0,67	0,63	0,60	0,57	0,55	0,52	0,50
13	1,63	1,44	1,30	1,18	1,08	1,00	0,93	0,87	0,81	0,76	0,72	0,68	0,65	0,62	0,59	0,57	0,54
14	1,75	1,56	1,40	1,27	1,17	1,08	1,00	0,93	0,88	0,82	0,78	0,74	0,70	0,67	0,64	0,61	0,58
15	1,88	1,67	1,50	1,36	1,25	1,15	1,07	1,00	0,94	0,88	0,83	0,79	0,75	0,71	0,68	0,65	0,63
16	2,00	1,78	1,60	1,46	1,33	1,23	1,14	1,07	1,00	0,94	0,89	0,84	0,80	0,76	0,73	0,70	0,67
17	2,13	1,89	1,70	1,55	1,42	1,31	1,21	1,13	1,06	1,00	0,94	0,89	0,85	0,81	0,77	0,74	0,71
18	2,25	2,00	1,80	1,64	1,50	1,38	1,29	1,20	1,13	1,06	1,00	0,95	0,90	0,86	0,82	0,78	0,75
19	2,38	2,11	1,90	1,73	1,58	1,46	1,36	1,27	1,19	1,12	1,06	1,00	0,95	0,90	0,86	0,83	0,79
20	2,50	2,22	2,00	1,82	1,67	1,54	1,43	1,33	1,25	1,18	1,11	1,05	1,00	0,95	0,91	0,87	0,83
21	2,63	2,33	2,10	1,91	1,75	1,62	1,50	1,40	1,31	1,24	1,17	1,11	1,05	1,00	0,95	0,91	0,88
22	2,75	2,44	2,20	2,00	1,83	1,69	1,57	1,47	1,38	1,29	1,22	1,16	1,10	1,05	1,00	0,96	0,92
23	2,88	2,56	2,30	2,09	1,92	1,77	1,64	1,53	1,44	1,35	1,28	1,21	1,15	1,10	1,05	1,00	0,96
24	3,00	2,67	2,40	2,18	2,00	1,85	1,71	1,60	1,50	1,41	1,33	1,26	1,20	1,14	1,09	1,04	1,00
25	3,13	2,78	2,50	2,27	2,08	1,92	1,79	1,67	1,56	1,47	1,39	1,32	1,25	1,19	1,14	1,09	1,04
26	3,25	2,89	2,60	2,36	2,17	2,00	1,86	1,73	1,63	1,53	1,44	1,37	1,30	1,24	1,18	1,13	1,08
27	3,38	3,00	2,70	2,46	2,25	2,08	1,93	1,80	1,69	1,59	1,50	1,42	1,35	1,29	1,23	1,17	1,13
28	3,50	3,11	2,80	2,55	2,33	2,15	2,00	1,87	1,75	1,65	1,56	1,47	1,40	1,33	1,27	1,22	1,17
29	3,63	3,22	2,90	2,64	2,42	2,23	2,07	1,93	1,81	1,71	1,61	1,53	1,45	1,38	1,32	1,26	1,21
30	3,75	3,33	3,00	2,73	2,50	2,31	2,14	2,00	1,88	1,76	1,67	1,58	1,50	1,43	1,36	1,30	1,25
31	3,88	3,44	3,10	2,82	2,58	2,38	2,21	2,07	1,94	1,82	1,72	1,63	1,55	1,48	1,41	1,35	1,29
32	4,00	3,56	3,20	2,91	2,67	2,46	2,29	2,13	2,00	1,88	1,78	1,68	1,60	1,52	1,45	1,39	1,33
33	4,13	3,67	3,30	3,00	2,75	2,54	2,36	2,20	2,06	1,94	1,83	1,74	1,65	1,57	1,50	1,43	1,38
34	4,25	3,78	3,40	3,09	2,83	2,62	2,43	2,27	2,13	2,00	1,89	1,79	1,70	1,62	1,55	1,48	1,42
35	4,38	3,89	3,50	3,18	2,92	2,69	2,50	2,33	2,19	2,06	1,94	1,84	1,75	1,67	1,59	1,52	1,46
36	4,50	4,00	3,60	3,27	3,00	2,77	2,57	2,40	2,25	2,12	2,00	1,89	1,80	1,71	1,64	1,57	1,50
37	4,63	4,11	3,70	3,36	3,08	2,85	2,64	2,47	2,31	2,18	2,06	1,95	1,85	1,76	1,68	1,61	1,54
38	4,75	4,22	3,80	3,46	3,17	2,92	2,71	2,53	2,38	2,24	2,11	2,00	1,90	1,81	1,73	1,65	1,58
39	4,88	4,33	3,90	3,55	3,25	3,00	2,79	2,60	2,44	2,29	2,17	2,05	1,95	1,86	1,77	1,70	1,63
40	5,00	4,44	4,00	3,64	3,33	3,08	2,86	2,67	2,50	2,35	2,22	2,11	2,00	1,90	1,82	1,74	1,67
41	5,13	4,56	4,10	3,73	3,42	3,15	2,93	2,73	2,56	2,41	2,28	2,16	2,05	1,95	1,86	1,78	1,71
42	5,25	4,67	4,20	3,82	3,50	3,23	3,00	2,80	2,63	2,47	2,33	2,21	2,10	2,00	1,91	1,83	1,75
43	5,38	4,78	4,30	3,91	3,58	3,31	3,07	2,87	2,69	2,53	2,39	2,26	2,15	2,05	1,95	1,87	1,79
44	5,50	4,89	4,40	4,00	3,67	3,38	3,14	2,93	2,75	2,59	2,44	2,32	2,20	2,10	2,00	1,91	1,83
45	5,63	5,00	4,50	4,09	3,75	3,46	3,21	3,00	2,81	2,65	2,50	2,37	2,25	2,14	2,05	1,96	1,88
46	5,75	5,11	4,60	4,18	3,83	3,54	3,29	3,07	2,88	2,71	2,56	2,42	2,30	2,19	2,09	2,00	1,92
47	5,88	5,22	4,70	4,27	3,92	3,62	3,36	3,13	2,94	2,76	2,61	2,47	2,35	2,24	2,14	2,04	1,96
48	6,00	5,33	4,80	4,36	4,00	3,69	3,43	3,20	3,00	2,82	2,67	2,53	2,40	2,29	2,18	2,09	2,00
49	6,13	5,44	4,90	4,46	4,08	3,77	3,50	3,27	3,06	2,88	2,72	2,58	2,45	2,33	2,23	2,13	2,04
50	6,25	5,56	5,00	4,55	4,17	3,85	3,57	3,33	3,13	2,94	2,78	2,63	2,50	2,38	2,27	2,17	2,08
51	6,38	5,67	5,10	4,64	4,25	3,92	3,64	3,40	3,19	3,00	2,83	2,68	2,55	2,43	2,32	2,22	2,13
52	6,50	5,78	5,20	4,73	4,33	4,00	3,71	3,47	3,25	3,06	2,89	2,74	2,60	2,48	2,36	2,26	2,17
53	6,63	5,89	5,30	4,82	4,42	4,08	3,79	3,53	3,31	3,12	2,94	2,79	2,65	2,52	2,41	2,30	2,21
54	6,75	6,00	5,40	4,91	4,50	4,15	3,86	3,60	3,38	3,18	3,00	2,84	2,70	2,57	2,45	2,35	2,25
55	6,88	6,11	5,50	5,00	4,58	4,23	3,93	3,67	3,44	3,24	3,06	2,89	2,75	2,62	2,50	2,39	2,29
56	7,00	6,22	5,60	5,09	4,67	4,31	4,00	3,73	3,50	3,29	3,11	2,95	2,80	2,67	2,55	2,43	2,33
57	7,13	6,33	5,70	5,18	4,75	4,38	4,07	3,80	3,56	3,35	3,17	3,00	2,85	2,71	2,59	2,48	2,38
58	7,25	6,44	5,80	5,27	4,83	4,46	4,14	3,87	3,63	3,41	3,22	3,05	2,90	2,76	2,64	2,52	2,42
60	7,50	6,67	6,00	5,45	5,00	4,62	4,29	4,00	3,75	3,53	3,33	3,16	3,00	2,86	2,73	2,61	2,50
62	7,75	6,89	6,20	5,64	5,17	4,77	4,43	4,13	3,88	3,65	3,44	3,26	3,10	2,95	2,82	2,70	2,58
63	7,88	7,00	6,30	5,73	5,25	4,85	4,50	4,20	3,94	3,71	3,50	3,32	3,15	3,00	2,86	2,74	2,63
64	8,00	7,11	6,40	5,82	5,33	4,92	4,57	4,27	4,00	3,76	3,56	3,37	3,20	3,05	2,90	2,78	2,67
65	8,13	7,22	6,50	5,91	5,42	5,00	4,64	4,33	4,06	3,82	3,61	3,42	3,25	3,10	2,95	2,83	2,71
66	8,25	7,33	6,60	6,00	5,50	5,08	4,71	4,40	4,13	3,88	3,67	3,47	3,30	3,14	3,00	2,87	2,75
68	8,50	7,56	6,80	6,18	5,67	5,23	4,86	4,53	4,25	4,00	3,78	3,58	3,40	3,24	3,09	2,96	2,83
70	8,75	7,78	7,00	6,36	5,83	5,38	5,00	4,67	4,38	4,12	3,89	3,68	3,50	3,33	3,18	3,04	2,92
72	9,00	8,00	7,20	6,55	6,00	5,54	5,14	4,80	4,50	4,24	4,00	3,79	3,60	3,43	3,27	3,13	3,00
75	9,38	8,33	7,50	6,82	6,25	5,77	5,36	5,00	4,69	4,41	4,17	3,95	3,75	3,57	3,41	3,26	3,13
76	9,50	8,44	7,60	6,91	6,33	5,85	5,43	5,07	4,75	4,47	4,22	4,00	3,80	3,62	3,45	3,30	3,17
78	9,75	8,67	7,80	7,09	6,50	6,00	5,57	5,20	4,88	4,59	4,33	4,11	3,90	3,71	3,55	3,39	3,25
80	10,00	8,89	8,00	7,27	6,67	6,15	5,71	5,33	5,00	4,71	4,44	4,21	4,00	3,81	3,64	3,48	3,33
85	10,63	9,44	8,50	7,73	7,08	6,54	6,07	5,67	5,31	5,00	4,72	4,47	4,25	4,05	3,86	3,70	3,54
90	11,25	10,00	9,00	8,18	7,50	6,92	6,43	6,00	5,63	5,29	5,00	4,74	4,50	4,29	4,09	3,91	3,75
95	11,88	10,56	9,50	8,64	7,92	7,31	6,79	6,33	5,94	5,59	5,28	5,00	4,75	4,52	4,32	4,13	3,96
96	12,00	10,67	9,60	8,73	8,00	7,38	6,86	6,40	6,00	5,65	5,33	5,05	4,80	4,57	4,36	4,17	4,00
100	12,50	11,11	10,00	9,09	8,33	7,69	7,14	6,67	6,25	5,88	5,56	5,26	5,00	4,76	4,55	4,35	4,17
114	14,25	12,67	11,40	10,36	9,50	8,77	8,14	7,60	7,13	6,71	6,33	6,00	5,70	5,43	5,18	4,96	4,75
125	15,63	13,89	12,50	11,36	10,42	9,62	8,93	8,33	7,81	7,35	6,94	6,58	6,25	5,95	5,68	5,43	5,21



**Rapporti di trasmissione / Ratio**

**Untersetzung / Rapport de transmission / Relaciones de transmision**

$$r = \frac{Z_2}{Z_1}$$

Z <sub>2</sub>	Z <sub>1</sub>															
	25	26	27	28	29	30	31	32	33	34	35	36	37	38	39	40
8	0,32	0,31	0,30	0,29	0,28	0,27	0,26	0,25	0,24	0,24	0,23	0,22	0,22	0,21	0,21	0,20
9	0,36	0,35	0,32	0,32	0,31	0,30	0,29	0,28	0,27	0,26	0,26	0,25	0,24	0,24	0,23	0,23
10	0,40	0,38	0,36	0,36	0,34	0,33	0,32	0,31	0,30	0,29	0,29	0,28	0,27	0,26	0,26	0,25
11	0,44	0,42	0,39	0,39	0,38	0,37	0,35	0,34	0,33	0,32	0,31	0,31	0,30	0,29	0,28	0,28
12	0,48	0,46	0,43	0,43	0,41	0,40	0,39	0,38	0,36	0,35	0,34	0,33	0,32	0,32	0,31	0,30
13	0,52	0,50	0,46	0,46	0,45	0,43	0,42	0,41	0,39	0,38	0,37	0,36	0,35	0,34	0,33	0,33
14	0,56	0,54	0,50	0,50	0,48	0,47	0,45	0,44	0,42	0,41	0,40	0,39	0,38	0,37	0,36	0,35
15	0,60	0,58	0,54	0,54	0,52	0,50	0,48	0,47	0,45	0,44	0,43	0,42	0,41	0,39	0,38	0,38
16	0,64	0,62	0,59	0,57	0,55	0,53	0,52	0,50	0,48	0,47	0,46	0,44	0,43	0,42	0,41	0,40
17	0,68	0,65	0,63	0,61	0,59	0,57	0,55	0,53	0,52	0,50	0,49	0,47	0,46	0,45	0,44	0,43
18	0,72	0,69	0,67	0,64	0,62	0,60	0,58	0,56	0,55	0,53	0,51	0,50	0,49	0,47	0,46	0,45
19	0,76	0,73	0,70	0,68	0,66	0,63	0,61	0,59	0,58	0,56	0,54	0,53	0,51	0,50	0,49	0,48
20	0,80	0,77	0,74	0,71	0,69	0,67	0,65	0,63	0,61	0,59	0,57	0,56	0,54	0,53	0,51	0,50
21	0,84	0,81	0,78	0,75	0,72	0,70	0,68	0,66	0,64	0,62	0,60	0,58	0,57	0,55	0,54	0,53
22	0,88	0,85	0,81	0,79	0,76	0,73	0,71	0,69	0,67	0,65	0,63	0,61	0,59	0,58	0,56	0,55
23	0,92	0,88	0,85	0,82	0,79	0,77	0,74	0,72	0,70	0,68	0,66	0,64	0,62	0,61	0,59	0,58
24	0,96	0,92	0,89	0,86	0,83	0,80	0,77	0,75	0,73	0,71	0,69	0,67	0,65	0,63	0,62	0,60
25	1,00	0,96	0,93	0,89	0,86	0,83	0,81	0,78	0,76	0,74	0,71	0,69	0,68	0,66	0,64	0,63
26	1,04	1,00	0,96	0,93	0,90	0,87	0,84	0,81	0,79	0,76	0,74	0,72	0,70	0,68	0,67	0,65
27	1,08	1,04	1,00	0,96	0,93	0,90	0,87	0,84	0,82	0,79	0,77	0,75	0,73	0,71	0,69	0,68
28	1,12	1,08	1,04	1,00	0,97	0,93	0,90	0,88	0,85	0,82	0,80	0,78	0,76	0,74	0,72	0,70
29	1,16	1,12	1,07	1,04	1,00	0,97	0,94	0,91	0,88	0,85	0,83	0,81	0,78	0,76	0,74	0,73
30	1,20	1,15	1,11	1,07	1,03	1,00	0,97	0,94	0,91	0,88	0,86	0,83	0,81	0,79	0,77	0,75
31	1,24	1,19	1,15	1,11	1,07	1,03	1,00	0,97	0,94	0,91	0,89	0,86	0,84	0,82	0,79	0,78
32	1,28	1,23	1,19	1,14	1,10	1,07	1,03	1,00	0,97	0,94	0,91	0,89	0,86	0,84	0,82	0,80
33	1,32	1,27	1,22	1,18	1,14	1,10	1,06	1,03	1,00	0,97	0,94	0,92	0,89	0,87	0,85	0,83
34	1,36	1,31	1,26	1,21	1,17	1,13	1,10	1,06	1,03	1,00	0,97	0,94	0,92	0,89	0,87	0,85
35	1,40	1,35	1,30	1,25	1,21	1,17	1,13	1,09	1,06	1,03	1,00	0,97	0,95	0,92	0,90	0,88
36	1,44	1,38	1,33	1,29	1,24	1,20	1,16	1,13	1,09	1,06	1,03	1,00	0,97	0,95	0,92	0,90
37	1,48	1,42	1,37	1,32	1,28	1,23	1,19	1,16	1,12	1,09	1,06	1,03	1,00	0,97	0,95	0,93
38	1,52	1,46	1,41	1,36	1,31	1,27	1,23	1,19	1,15	1,12	1,09	1,06	1,03	1,00	0,97	0,95
39	1,56	1,50	1,44	1,39	1,34	1,30	1,26	1,22	1,18	1,15	1,11	1,08	1,05	1,03	1,00	0,98
40	1,60	1,54	1,48	1,43	1,38	1,33	1,29	1,25	1,21	1,18	1,14	1,11	1,08	1,05	1,03	1,00
41	1,64	1,58	1,52	1,46	1,41	1,37	1,32	1,28	1,24	1,21	1,17	1,14	1,11	1,08	1,05	1,03
42	1,68	1,62	1,56	1,50	1,45	1,40	1,35	1,31	1,27	1,24	1,20	1,17	1,14	1,11	1,08	1,05
43	1,72	1,65	1,59	1,54	1,48	1,43	1,39	1,34	1,30	1,26	1,23	1,19	1,16	1,13	1,10	1,08
44	1,76	1,69	1,63	1,57	1,52	1,47	1,42	1,38	1,33	1,29	1,26	1,22	1,19	1,16	1,13	1,10
45	1,80	1,73	1,67	1,61	1,55	1,50	1,45	1,41	1,36	1,32	1,29	1,25	1,22	1,18	1,15	1,13
46	1,84	1,77	1,70	1,64	1,59	1,53	1,48	1,44	1,39	1,35	1,31	1,28	1,24	1,21	1,18	1,15
47	1,88	1,81	1,74	1,68	1,62	1,57	1,52	1,47	1,42	1,38	1,34	1,31	1,27	1,24	1,21	1,18
48	1,92	1,85	1,78	1,71	1,66	1,60	1,55	1,50	1,45	1,41	1,37	1,33	1,30	1,26	1,23	1,20
49	1,96	1,88	1,81	1,75	1,69	1,63	1,58	1,53	1,48	1,44	1,40	1,36	1,32	1,29	1,26	1,23
50	2,00	1,92	1,85	1,79	1,72	1,67	1,61	1,56	1,52	1,47	1,43	1,39	1,35	1,32	1,28	1,25
51	2,04	1,96	1,89	1,82	1,76	1,70	1,65	1,59	1,55	1,50	1,46	1,42	1,38	1,34	1,31	1,28
52	2,08	2,00	1,93	1,86	1,79	1,73	1,68	1,63	1,58	1,53	1,49	1,44	1,41	1,37	1,33	1,30
53	2,12	2,04	1,96	1,89	1,83	1,77	1,71	1,66	1,61	1,56	1,51	1,47	1,43	1,39	1,36	1,33
54	2,16	2,08	2,00	1,93	1,86	1,80	1,74	1,69	1,64	1,59	1,54	1,50	1,46	1,42	1,38	1,35
55	2,20	2,12	2,04	1,96	1,90	1,83	1,77	1,72	1,67	1,62	1,57	1,53	1,49	1,45	1,41	1,38
56	2,24	2,15	2,07	2,00	1,93	1,87	1,81	1,75	1,70	1,65	1,60	1,56	1,51	1,47	1,44	1,40
57	2,28	2,19	2,11	2,04	1,97	1,90	1,84	1,78	1,73	1,68	1,63	1,58	1,54	1,50	1,46	1,43
58	2,32	2,23	2,15	2,07	2,00	1,93	1,87	1,81	1,76	1,71	1,66	1,61	1,57	1,53	1,49	1,45
60	2,40	2,31	2,22	2,14	2,07	2,00	1,94	1,88	1,82	1,76	1,71	1,67	1,62	1,58	1,54	1,50
62	2,48	2,38	2,30	2,21	2,14	2,07	2,00	1,94	1,88	1,82	1,77	1,72	1,68	1,63	1,59	1,55
63	2,52	2,42	2,33	2,25	2,17	2,10	2,03	1,97	1,91	1,85	1,80	1,75	1,70	1,66	1,62	1,58
64	2,56	2,46	2,37	2,29	2,21	2,13	2,06	2,00	1,94	1,88	1,83	1,78	1,73	1,68	1,64	1,60
65	2,60	2,50	2,41	2,32	2,24	2,17	2,10	2,03	1,97	1,91	1,86	1,81	1,76	1,71	1,67	1,63
66	2,64	2,54	2,44	2,36	2,28	2,20	2,13	2,06	2,00	1,94	1,89	1,83	1,78	1,74	1,69	1,65
68	2,72	2,62	2,52	2,43	2,34	2,27	2,19	2,13	2,06	2,00	1,94	1,89	1,84	1,79	1,74	1,70
70	2,80	2,69	2,59	2,50	2,41	2,33	2,26	2,19	2,12	2,06	2,00	1,94	1,89	1,84	1,79	1,75
72	2,88	2,77	2,67	2,57	2,48	2,40	2,32	2,25	2,18	2,12	2,06	2,00	1,95	1,89	1,85	1,80
75	3,00	2,88	2,78	2,68	2,59	2,50	2,42	2,34	2,27	2,21	2,14	2,08	2,03	1,97	1,92	1,88
76	3,04	2,92	2,81	2,71	2,62	2,53	2,45	2,38	2,30	2,24	2,17	2,11	2,05	2,00	1,95	1,90
78	3,12	3,00	2,89	2,79	2,69	2,60	2,52	2,44	2,36	2,29	2,23	2,17	2,11	2,05	2,00	1,95
80	3,20	3,10	2,96	2,86	2,76	2,67	2,58	2,50	2,42	2,35	2,29	2,22	2,16	2,11	2,05	2,00
85	3,40	3,27	3,15	3,04	2,93	2,83	2,74	2,66	2,58	2,50	2,43	2,36	2,30	2,24	2,18	2,13
90	3,60	3,46	3,33	3,21	3,10	3,00	2,90	2,81	2,73	2,65	2,57	2,50	2,43	2,37	2,31	2,25
95	3,80	3,65	3,52	3,39	3,28	3,17	3,06	2,97	2,88	2,79	2,71	2,64	2,57	2,50	2,44	2,38
96	3,84	3,69	3,56	3,43	3,31	3,20	3,10	3,00	2,91	2,82	2,74	2,67	2,59	2,53	2,46	2,40
100	4,00	3,85	3,70	3,57	3,45	3,33	3,23	3,13	3,03	2,94	2,86	2,78	2,70	2,63	2,56	2,50
114	4,56	4,38	4,22	4,07	3,93	3,80	3,68	3,56	3,45	3,35	3,26	3,17	3,08	3,00	2,92	2,85
125	5,00	4,81	4,63	4,46	4,31	4,17	4,03	3,91	3,79	3,68	3,57	3,47	3,38	3,29	3,21	3,13



# Speciale Standard Special Standard Sonder-Standardteile Standard Spécial Estándar Especial



## **propone** “SPECIALE STANDARD”

Dalla valutazione dei dati storici di vendita, la , presente da diversi anni sul mercato nazionale ed internazionale con una gamma completa di articoli di trasmissione, ha riscontrato la crescente richiesta di particolari con speciali caratteristiche, quali foro in tolleranza H7, sede per chiavette UNI e fori per bloccaggio. In questa ottica la  ha voluto proporsi ai mercati con una gamma di articoli dalle caratteristiche speciali pronti a magazzino facendo risparmiare al cliente costi di gestione non sempre quantificabili, per l'esecuzione delle varie lavorazioni.

La disponibilità in stock dello “SPECIALE STANDARD” rappresenta un nostro punto di forza nel servizio con garanzia di pronta consegna e quotazioni competitive sui piccoli e grandi quantitativi.

Inoltre, tutte le lavorazioni trovano un unico interlocutore nel collaudo finale del particolare.

## **proposes** “SPECIAL STANDARD”

As a result of the evaluation of the past selling records, the , for several years on the national and international market with a complete range of power transmission products, has come across an increasing demand of items with special features such as bore with H7 tolerance, UNI keyways and set screws for locking. With this idea, the  company wishes to introduce into the market a new range of special items available on stock, meaning a substantial saving for the customers in terms of machining costs required, which are often difficult to quantify.

The possibility of having the “SPECIAL STANDARD” ready on stock represents our strong point in terms of service, and imply quick deliveries and competitive prices in large as much as in small quantities.

What is more, all the variations meet one single interlocutor in the final test reserved to the piece.

## **präsentiert die Produktreihe** “SONDER-STANDARDTEILE”

Eine Auswertung der Verkaufszahlen zeigte den Technikern der  - ein Unternehmen, das den italienischen und internationalen Markt seit vielen Jahren mit einem umfassenden Angebot an Antriebs-elementen beliefert - daß eine steigende Nachfrage nach Sonderteilen mit Bohrungen mit Toleranzklasse H7, Paßfedernuten nach UNI-Norm sowie Gewindebohrungen für Sicherungsschrauben besteht.

Als Antwort auf diesen Bedarf präsentiert die  eine direkt ab Lager abrufbare Produktreihe von Sonderteile, durch die der Kunde alle bei einer Eigenherstellung der jeweiligen Teile anfallenden, nicht immer quantifizierbaren Kosten spart.

Die unmittelbare Verfügbarkeit der “SONDER-STANDARD TEILE” stellt das große Plus im Kundenservice der  dar. Weitere Vorteile für den Kunden sind prompte Lieferungen und konkurrenzfähige Preise für kleine und große Stückzahlen.

Außerdem ergibt sich hierdurch für sämtliche Bearbeitungen ein fester Ansprechpartner bei der Endprüfung der Teile.

## **propose** “STANDARD SPÉCIAL”

Après évaluation des données historiques de vente, , présente depuis plusieurs années sur le marché national et international avec une gamme complète de produits de transmission, a constaté la demande croissante de pièces ayant des caractéristiques spéciales, tels que alésage tolérance H7, siège pour clavette UNI et trous taraudés.

Dans cette optique,  a voulu proposer aux marchés une gamme d'articles usinés prêts au magasin, permettant au client d'économiser sur les coûts de gestion de l'exécution des différents usinages qui ne sont pas toujours quantifiables. La disponibilité en stock du “Spécial Standard” est le point fort de notre service qui assure livraisons rapides et prix compétitifs sur les petites et grandes quantités.

En outre, tous les usinages ont un interlocuteur unique lors de l'essai final de la pièce.

## **propone** “ESTÁNDAR ESPECIAL”

De la valoración de los datos históricos de venta, la , presente desde hace años en el mercado nacional e internacional con una gama completa de artículos de transmisión, ha detectado un creciente interés por piezas con características especiales, como el agujero de tolerancia H7, alojamiento para chavetas UNI y agujeros fileteados para bloqueo.

Con esta óptica la  ha querido proponer a los mercados una gama de productos con características especiales listas en stock, ahorrando así al cliente los costes difícilmente cuantificables de la ejecución de las variaciones requeridas.

La disponibilidad en stock del “ESTÁNDAR ESPECIAL” representa el punto fuerte de nuestro servicio con la garantía de un rápida entrega y costes competitivos, tanto en pequeñas como en grandes cantidades.

Además, todas las variaciones tienen un único interlocutor en el documento de certificación final de la pieza.

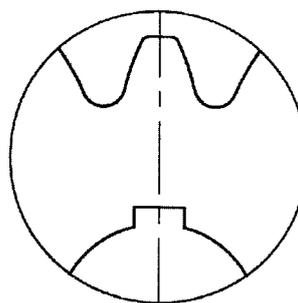

**N.B.**  
Pignoni **temprati ad induzione** sui denti (45 ÷ 55 HRC).  
La sede linguetta è in asse con il dente.

**N.B.**  
Sprockets have **induction hardened** teeth (45 ÷ 55 HRC).  
Keyway is located on center line of tooth.

**N.B.**  
Kettenraeder haben **induktionsgehaertete** Zaehne (45 ÷ 55 HRC).  
Die Keilnut befindet sich auf Zahnmitte.

**N.B.**  
Pignons ont denture **traitée par induction** (45 ÷ 55 HRC).  
La rainure de clavette se trouve exactement en axe du dent.

**N.B.**  
Piñones tienen dientes **templados por inducción** (45 ÷ 55 HRC).  
La chaveta está exactamente en línea con el diente.

D (H7)	b (H9)	T		M
10	3	D + 1,4	(+0,1/0)	M3
11	4	D + 1,8	(+0,1/0)	M3
12	4	D + 1,8	(+0,1/0)	M3
14	5	D + 2,3	(+0,1/0)	M4
15	5	D + 2,3	(+0,1/0)	M4
16	5	D + 2,3	(+0,1/0)	M4
18	6	D + 2,8	(+0,1/0)	M5
19	6	D + 2,8	(+0,1/0)	M5
20	6	D + 2,8	(+0,1/0)	M5
22	6	D + 2,8	(+0,1/0)	M5
24	8	D + 3,3	(+0,2/0)	M6
25	8	D + 3,3	(+0,2/0)	M6
28	8	D + 3,3	(+0,2/0)	M6
30	8	D + 3,3	(+0,2/0)	M6
32	10	D + 3,3	(+0,2/0)	M8
35	10	D + 3,3	(+0,2/0)	M8
38	10	D + 3,3	(+0,2/0)	M8
40	12	D + 3,3	(+0,2/0)	M10
42	12	D + 3,3	(+0,2/0)	M10
45	14	D + 3,8	(+0,2/0)	M12
48	14	D + 3,8	(+0,2/0)	M12
50	14	D + 3,8	(+0,2/0)	M12
60	18	D + 4,4	(+0,2/0)	M12
65	18	D + 4,4	(+0,2/0)	M12
70	20	D + 4,9	(+0,2/0)	M12

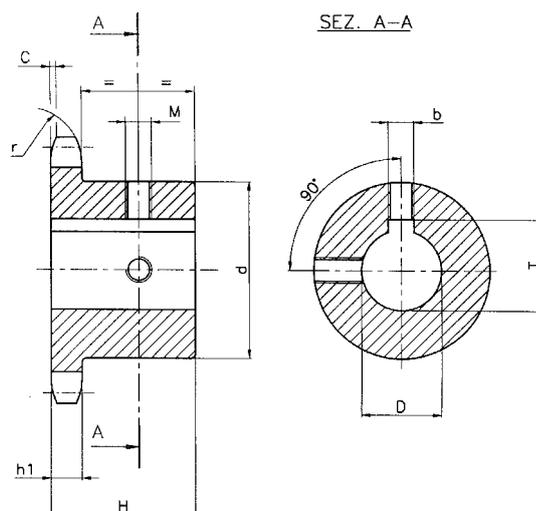

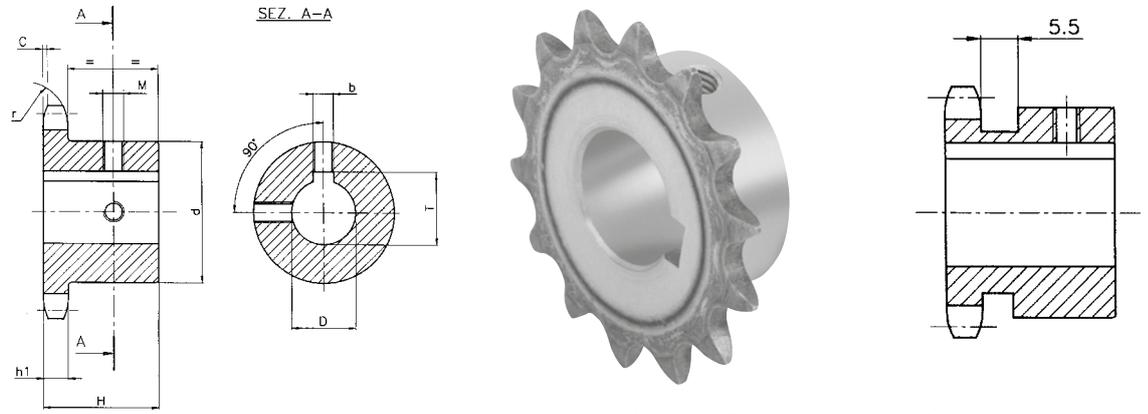

3/8" x 7/32"

Versione (\*) / Type (\*) / Typ (\*) / Tipo (\*)

**06B-1 9,525 x 5,72 mm**

DIN 8187 ISO/R606

CATENA	CHAIN	KETTE	CHAÎNE	CADENA	ISO mm
Passo	Pitch	Teilung	Pas	Paso	<b>9,525</b>
Larghezza interna	Internal width	Innere Breite	Largeur interieure	Ancho interno	<b>5,720</b>
Rullo ø	Roller ø	Rollen ø	ø du rouleau	Rodillo ø	<b>6,350</b>

PIGNONE	SPROCKETS	KETTENRÄDER	PIGNONS	PIÑONES		
Raggio dente r	Tooth radius r	Radius r	Rayon de denture r	Radio diente r	<b>r</b>	<b>10,0</b>
Larghezza raggio C	Radius width C	Breite C	Largeur de rayon C	Ancho radio C	<b>C</b>	<b>1,0</b>
Largh. Dente h <sub>1</sub>	Tooth width h <sub>1</sub>	Zahnbreite h <sub>1</sub>	Larg. de denture h <sub>1</sub>	Ancho diente h <sub>1</sub>	<b>h<sub>1</sub></b>	<b>5,3</b>

b-T-M pag. / page 19

**Materiale C 45 E  
UNI EN 10083-1**

**Material C 45 E  
UNI EN 10083-1**

**Werkstoff C 45 E  
UNI EN 10083-1**

**Matière C 45 E  
UNI EN 10083-1**

**Material C 45 E  
UNI EN 10083-1**

Cod.	Z	D	H	d	Cod.	Z	D	H	d	Cod.	Z	D	H	d
05SA010	10	10	22	24*	05SB416	16	24	28	42*	05SA821	21	18	28	48
05SA110		11			05SB516		25			05SA921		19		
05SA210		12			05SA217		12			05SB021		20		
05SA410	11	14	25	29*	05SA417	17	14	28	40	05SB221	22	22	28	50
05SA011		10			05SA517		15			05SB421		24		
05SA211		12			05SA617		16			05SB521		25		
05SA411	12	14	25	29*	05SA817	18	18	28	42	05SA522	22	15	28	52
05SA511		15			05SA917		19			05SA622		16		
05SA611		16			05SB017		20			05SA822		18		
05SA012	13	10	25	28	05SB217	19	22	28	43	05SA922	23	19	28	54
05SA212		12			05SB417		24			05SB022		20		
05SA412		14			05SB517		25			05SB222		22		
05SA512	14	15	25	31*	05SA218	18	12	28	45	05SB422	24	24	28	57
05SA612		16			05SA418		14			05SB522		25		
05SA013		10			05SA518		15			05SA523		15		
05SA213	15	12	25	31*	05SA618	19	16	28	46	05SA623	24	16	30	60
05SA413		14			05SA818		18			05SA823		18		
05SA513		15			05SA918		19			05SA923		19		
05SA613	16	16	25	35*	05SB018	20	20	28	48	05SA923	25	20	30	60
05SA813		18			05SB218		22			05SB023		20		
05SA214		12			05SB418		24			05SB223		22		
05SA414	17	14	25	31	05SB518	21	25	28	49	05SB423	24	24	30	60
05SA514		15			05SA219		12			05SB523		25		
05SA614		16			05SA419		14			05SA523		15		
05SA814	18	18	25	35*	05SA519	22	15	28	50	05SA624	25	16	30	60
05SA914		19			05SA619		16			05SA824		18		
05SA215		12			05SA819		18			05SA924		19		
05SA415	19	14	25	34	05SA919	23	19	28	51	05SB024	26	20	30	60
05SA515		15			05SB019		20			05SB224		22		
05SA615		16			05SB219		22			05SB424		24		
05SA815	20	18	25	35	05SB419	24	24	28	52	05SB524	25	25	30	60
05SA915		19			05SB519		25			05SA625		16		
05SB015		20			05SA220		12			05SA825		18		
05SB215	21	22	25	38*	05SA420	25	14	28	53	05SA925	26	19	30	60
05SB415		24			05SA520		15			05SB025		20		
05SB515		25			05SA620		16			05SB225		22		
05SA216	22	12	28	42*	05SA820	26	18	28	54	05SB425	24	24	30	60
05SA416		14			05SA920		19			05SB525		25		
05SA516		15			05SB020		20			05SB830		28		
05SA616	23	16	28	46	05SB220	27	22	28	55	05SB830	28	28	30	60
05SA816		18			05SB420		24			05SC030		30		
05SA916		19			05SB520		25							
05SB016	24	20	28	48	05SA521	28	15	28	56		30		30	60
05SB216		22			05SA621		16							

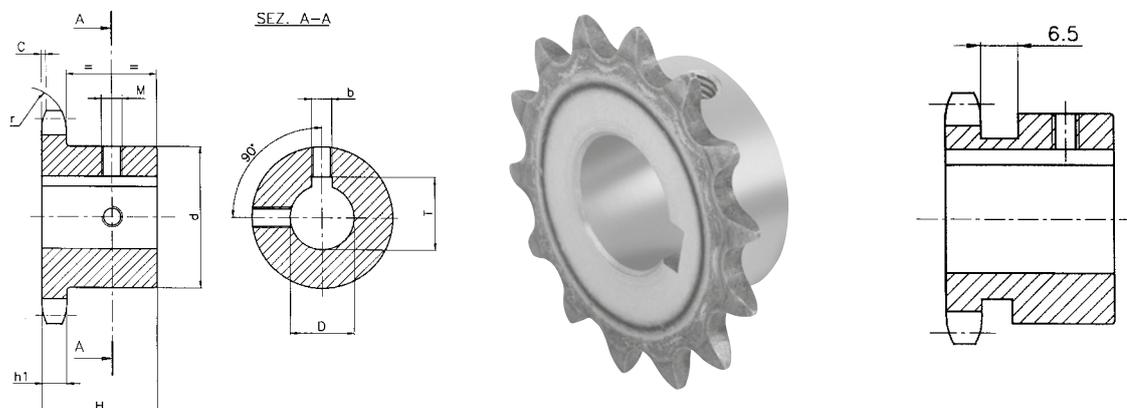

1/2" x 5/16"

Versione (\*) / Type (\*) / Typ (\*) / Tipo (\*)

**08B-1 12,7 x 7,75 mm**

DIN 8187 ISO/R606

CATENA	CHAIN	KETTE	CHAÎNE	CADENA	ISO mm
Passo	Pitch	Teilung	Pas	Paso	12,7
Larghezza interna	Internal width	Innere Breite	Largeur interieure	Ancho interno	7,8
Rullo ø	Roller ø	Rollen ø	ø du rouleau	Rodillo ø	8,5

PIGNONE	SPROCKETS	KETTENRÄDER	PIGNONS	PIÑONES	
Raggio dente r	Tooth radius r	Radius r	Rayon de denture r	Radio diente r	r 13,0
Larghezza raggio C	Radius width C	Breite C	Largeur de rayon C	Ancho radio C	C 1,3
Largh. Dente h <sub>1</sub>	Tooth width h <sub>1</sub>	Zahnbreite h <sub>1</sub>	Larg. de denture h <sub>1</sub>	Ancho diente h <sub>1</sub>	h <sub>1</sub> 7,2

b-T-M pag. / page 19

Materiale C 45 E  
UNI EN 10083-1

Material C 45 E  
UNI EN 10083-1

Werkstoff C 45 E  
UNI EN 10083-1

Matière C 45 E  
UNI EN 10083-1

Material C 45 E  
UNI EN 10083-1

Cod.	Z	D	H	d	Cod.	Z	D	H	d	Cod.	Z	D	H	d	Cod.	Z	D	H	d	
09SA210	10	12	25	26	09SA515	15	15	28	45	09SC818	18	38	28	56	09SB822	22	28	28	70	70
09SA410		14		29*	09SA615		16			09SA819		18		09SC022	30					
09SA510		15		30*	09SA815		18			09SA919		19		09SC222	32					
09SA610		16		31*	09SA915		19			09SB019		20		09SC522	35					
09SA211	11	12	25	29	09SB015	16	20	28	50	09SB822	19	38	28	70	09SA923	23	19	28	70	
09SA411		14		31	09SB215		22			09SB219		22			09SA923		20			
09SA511		15		30	09SB415		24			09SB419		24			09SB023		20			
09SA611		16		31	09SB515		25			09SB519		25			09SB223		22			
09SA811	18	34*	09SB815	28	09SB819	28	09SB423	24												
09SA911	19	35*	09SC015	30	09SC019	30	09SB523	25												
09SA212	12	12	28	47	09SC219	20	32	28	64	09SB823	24	28	28	70	09SC023	24	28	28	70	
09SA412		14		49*	09SA516		15			09SC219		32			09SB823		28			
09SA512		15		33	09SA616		16			09SC519		35			09SC023		30			
09SA612		16		36	09SA816		18			09SC819		38			09SC223		32			
09SA812	18	38*	09SA916	19	09SA620	16	09SC523	35												
09SA912	19	41*	09SB016	20	09SA820	18	09SC823	38												
09SB012	20	42*	09SB216	22	09SA920	19	09SA924	19												
09SB212	22	42*	09SB416	24	09SB020	20	09SB024	20												
09SB412	24	42*	09SB516	25	09SB220	22	09SB224	22												
09SB512	25	42*	09SB816	28	09SB420	24	09SB424	24												
09SA213	13	12	28	53*	09SB520	20	25	28	68	09SB524	24	25	28	70	09SB824	25	25	28	70	
09SA413		14		53*	09SC016		30			09SB820		28			09SB824		28			
09SA513		15		37	09SC216		32			09SC020		30			09SC024		30			
09SA613		16		42*	09SA517		15			09SC220		32			09SC224		32			
09SA813	18	42*	09SA617	16	09SC520	35	09SC524	35												
09SA913	19	45*	09SA817	18	09SC820	38	09SC824	38												
09SB013	20	45*	09SA917	19	09SA621	16	09SA925	19												
09SB213	22	45*	09SB017	20	09SA821	18	09SB025	20												
09SB413	24	45*	09SB217	22	09SA921	19	09SB225	22												
09SB513	25	45*	09SB417	24	09SB021	20	09SB425	24												
09SB813	28	45*	09SB517	25	09SB221	22	09SB525	25												
09SA214	14	12	28	56	09SB817	21	28	28	70	09SB825	25	28	28	70	09SB825	25	28	28	70	
09SA414		14		56	09SC017		30			09SB421		24			09SC025		30			
09SA514		15		41	09SC217		32			09SB521		25			09SC225		32			
09SA614		16		41	09SA618		16			09SB821		28			09SC525		35			
09SA814	18	41	09SA818	18	09SC021	30	09SC825	38												
09SA914	19	41	09SA918	19	09SC221	32	09SB530	25												
09SB014	20	41	09SB018	20	09SC521	35	09SB830	28												
09SB214	22	41	09SB218	22	09SC821	38	09SC030	30												
09SB414	24	41	09SB418	24	09SA622	16	09SC030	30												
09SB514	25	41	09SB518	25	09SA822	18	09SC230	32												
09SB814	28	41	09SB818	28	09SA922	19	09SC530	35												
09SA215	15	12	28	56	09SC018	22	20	28	70	09SB022	22	22	28	70	09SB222	22	22	28	70	
09SA415		14		45	09SC218		32			09SB422		24			09SB422		24			
					09SC518		35			09SB522		25								

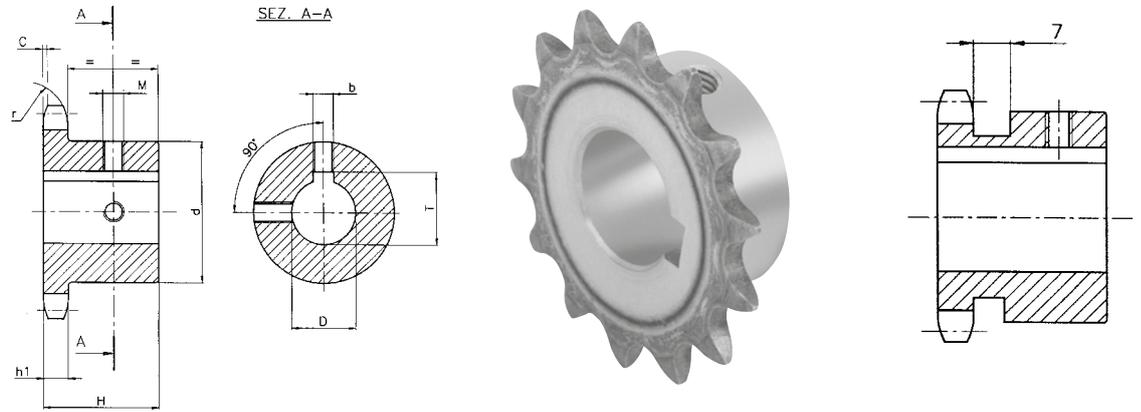

5/8" x 3/8"

Versione (\*) / Type (\*) / Typ (\*) / Tipo (\*)

**10B-1 15,875 x 9,65 mm**

DIN 8187 ISO/R606

CATENA	CHAIN	KETTE	CHAÎNE	CADENA	ISO mm
Passo	Pitch	Teilung	Pas	Paso	15,875
Larghezza interna	Internal width	Innere Breite	Largeur interieure	Ancho interno	9,700
Rullo ø	Roller ø	Rollen ø	ø du rouleau	Rodillo ø	10,000

PIGNONE	SPROCKETS	KETTENRÄDER	PIGNONS	PIÑONES	
Raggio dente r	Tooth radius r	Radius r	Rayon de denture r	Radio diente r	r 16,0
Larghezza raggio C	Radius width C	Breite C	Largeur de rayon C	Ancho radio C	C 1,6
Largh. Dente h <sub>1</sub>	Tooth width h <sub>1</sub>	Zahnbreite h <sub>1</sub>	Larg. de denture h <sub>1</sub>	Ancho diente h <sub>1</sub>	h <sub>1</sub> 9,1

b-T-M pag. / page 19

Materiale C 45 E  
UNI EN 10083-1

Material C 45 E  
UNI EN 10083-1

Werkstoff C 45 E  
UNI EN 10083-1

Matière C 45 E  
UNI EN 10083-1

Material C 45 E  
UNI EN 10083-1

Cod.	Z	D	H	d	Cod.	Z	D	H	d	Cod.	Z	D	H	d	Cod.	Z	D	H	d	
10SA510	10	15	25	35	10SB814	14	28	30	52	10SA919	19	19	30	70	10SC522	22	35	30	80	
10SA610		16			10SC014		30			10SB019		20			10SC822		38			
10SA910		19			10SC214		32			10SB219		22			10SD022		40			
10SB010		20			10SA915		19			10SB419		24			10SD222		42			
10SB410		24			10SB015		20			10SB519		25			10SA923		19			
10SA511	11	15	30	37	10SB215	15	22	30	57	10SB819	19	28	30	70	10SB023	23	20	30	80	
10SA611		16			10SB415		24			10SC019		30			10SB223		22			
10SA811		18			10SB515		25			10SC219		32			10SB423		24			
10SA911		19			10SB815		28			10SC519		35			10SB523		25			
10SB011		20			10SC015		30			10SC819		38			10SB823		28			
10SB411		24			10SC215		32			10SD019		40			10SC023		30			
10SB511		25			10SC515		35			10SD219		42			10SC223		32			
10SB811		28			10SA916		19			10SA920		19			10SC523		35			
10SC011		30			10SB016		20			10SB020		20			10SC823		38			
10SA512		15			10SB216		22			10SB220		22			10SB823		28			
10SA612	16	10SB416	24	10SB420	24	10SD023	40													
10SA812	18	10SB516	25	10SB520	25	10SD223	42													
10SA912	19	10SB816	28	10SB820	28	10SA924	19													
10SB012	20	10SC016	30	10SC020	30	10SB024	20													
10SB212	22	10SC216	32	10SC220	32	10SB224	22													
10SB412	24	10SC516	35	10SC520	35	10SB424	24													
10SB512	25	10SC816	38	10SC820	38	10SB524	25													
10SB812	28	10SA917	19	10SD020	40	10SB824	28													
10SC012	30	10SB017	20	10SD220	42	10SC024	30													
10SC212	32	10SB217	22	10SA921	19	10SC224	32													
10SA513	15	10SB417	24	10SB021	20	10SC524	35													
10SA613	16	10SB517	25	10SB221	22	10SC824	38													
10SA813	18	10SB817	28	10SB421	24	10SD024	40													
10SA913	19	10SC017	30	10SB521	25	10SD224	42													
10SB013	20	10SC217	32	10SB821	28	10SA925	19													
10SB213	22	10SC517	35	10SC021	30	10SB025	20													
10SB413	24	10SB817	38	10SC221	32	10SB225	22													
10SB513	25	10SA918	19	10SC521	35	10SB425	24													
10SB813	28	10SB018	20	10SC821	38	10SB525	25													
10SC013	30	10SB218	22	10SD021	40	10SB825	28													
10SC213	32	10SB418	24	10SD221	42	10SC025	30													
10SA514	15	10SB518	25	10SA922	19	10SC225	32													
10SA614	16	10SB818	28	10SB022	20	10SC525	35													
10SA814	18	10SC018	30	10SB222	22	10SC825	38													
10SA914	19	10SC218	32	10SB422	24	10SD025	40													
10SB014	20	10SC518	35	10SB522	25	10SD225	42													
10SB214	22	10SC818	38	10SB822	28															
10SB414	24	10SD018	40	10SC022	30															
10SB514	25	10SD218	42	10SC222	32															



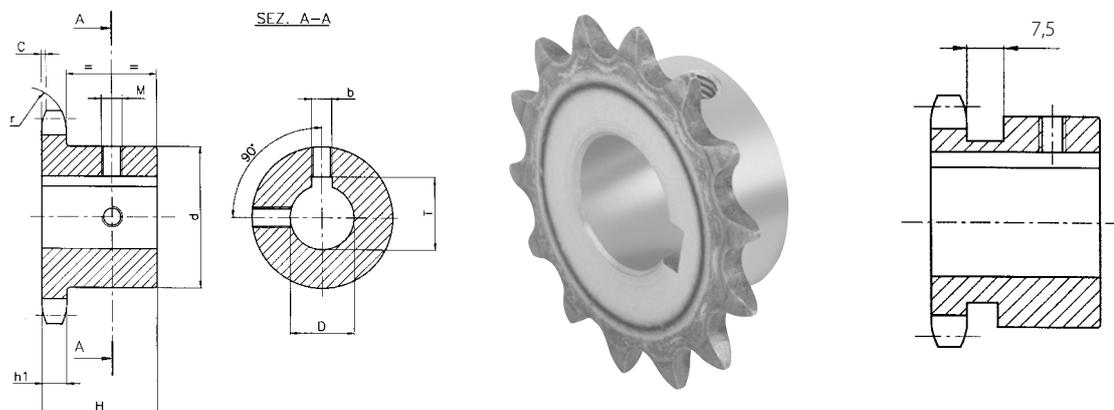

**3/4" x 7/16"**

Versione (\*) / Type (\*) / Typ (\*) / Tipo (\*)

**12B-1 19,05 x 11,68 mm**

**DIN 8187 ISO/R606**

CATENA	CHAIN	KETTE	CHAÎNE	CADENA	ISO mm
Passo	Pitch	Teilung	Pas	Paso	<b>19,05</b>
Larghezza interna	Internal width	Innere Breite	Largeur interieure	Ancho interno	<b>11,68</b>
Rullo ø	Roller ø	Rollen ø	ø du rouleau	Rodillo ø	<b>12,07</b>

PIGNONE	SPROCKETS	KETTENRÄDER	PIGNONS	PIÑONES	
Raggio dente r	Tooth radius r	Radius r	Rayon de denture r	Radio diente r	<b>r 19,0</b>
Larghezza raggio C	Radius width C	Breite C	Largeur de rayon C	Ancho radio C	<b>C 2,0</b>
Largh. Dente h <sub>1</sub>	Tooth width h <sub>1</sub>	Zahnbreite h <sub>1</sub>	Larg. de denture h <sub>1</sub>	Ancho diente h <sub>1</sub>	<b>h<sub>1</sub> 11,1</b>

b-T-M pag. / page 19

**Materiale C 45 E  
UNI EN 10083-1**

**Material C 45 E  
UNI EN 10083-1**

**Werkstoff C 45 E  
UNI EN 10083-1**

**Matière C 45 E  
UNI EN 10083-1**

**Material C 45 E  
UNI EN 10083-1**

Cod.	Z	D	H	d	Cod.	Z	D	H	d	Cod.	Z	D	H	d	Cod.	Z	D	H	d
11SA910	10	19	30	42	11SA915	15	19	35	70	11SD019	19	40	35	80	11SD023	23	40	40	90
11SB010		20			11SB015		20			11SD219		42			11SD223		42		
11SB410		24			11SB215		22			11SD519		45			11SD523		45		
11SB510		25			11SB415		24			11SD819		48			11SD823		48		
11SB810		28			11SB515		25			11SE019		50			11SE023		50		
11SC010		30			11SB815		28			11SB520		25			11SB524		25		
11SC210	32	11SC015	30	11SB820	28	11SB824	28												
11SA911	11	19	35	46	11SC215	16	32	35	75	11SC020	20	30	35	80	11SC024	24	30	40	90
11SB011		20			11SC515		35			11SC220		32			11SC224		32		
11SB411		24			11SC815		38			11SC520		35			11SC524		35		
11SB511		25			11SD015		40			11SC820		38			11SC824		38		
11SB811		28			11SA916		19			11SD020		40			11SD024		40		
11SC011		30			11SB016		20			11SD220		42			11SD224		42		
11SC211	32	11SB216	22	11SD520	45	11SD524	45												
11SA912	12	19	35	52	11SB416	17	24	35	80	11SD820	21	48	40	90	11SD824	25	48	40	90
11SB012		20			11SB516		25			11SE020		50			11SE024		50		
11SB212		22			11SB816		28			11SB521		25			11SB525		25		
11SB412		24			11SC016		30			11SB821		28			11SB825		28		
11SB512		25			11SC216		32			11SC021		30			11SC025		30		
11SB812		28			11SC516		35			11SC221		32			11SC225		32		
11SC012	30	11SC816	38	11SC521	35	11SC525	35												
11SC212	32	11SD016	40	11SC821	38	11SC825	38												
11SC512	35	11SB517	25	11SD021	40	11SD025	40												
11SA913	13	19	35	58	11SB817	18	28	35	80	11SD221	22	42	40	90	11SD225	25	42	40	90
11SB013		20			11SC017		30			11SD521		45			11SD525		45		
11SB213		22			11SC217		32			11SD821		48			11SD825		48		
11SB413		24			11SC517		35			11SE021		50			11SE025		50		
11SB513		25			11SC817		38			11SB522		25							
11SB813		28			11SD017		40			11SB822		28							
11SC013	30	11SD217	42	11SC022	30														
11SC213	32	11SB518	25	11SC222	32														
11SC513	35	11SB818	28	11SC522	35														
11SC813	38	11SC018	30	11SC822	38														
11SA914	14	19	35	64	11SC218	19	32	35	80	11SD022	23	40	40	90		23	40	40	90
11SB014		20			11SC518		35			11SD222		42							
11SB214		22			11SC818		38			11SD522		45							
11SB414		24			11SD018		40			11SD822		48							
11SB514		25			11SD218		42			11SE022		50							
11SB814		28			11SB519		25			11SB523		25							
11SC014	30	11SB819	28	11SB823	28														
11SC214	32	11SC019	30	11SC023	30														
11SC514	35	11SC219	32	11SC223	32														
11SC814	38	11SC519	35	11SC523	35														
11SD014	40	11SC819	38	11SC823	38														

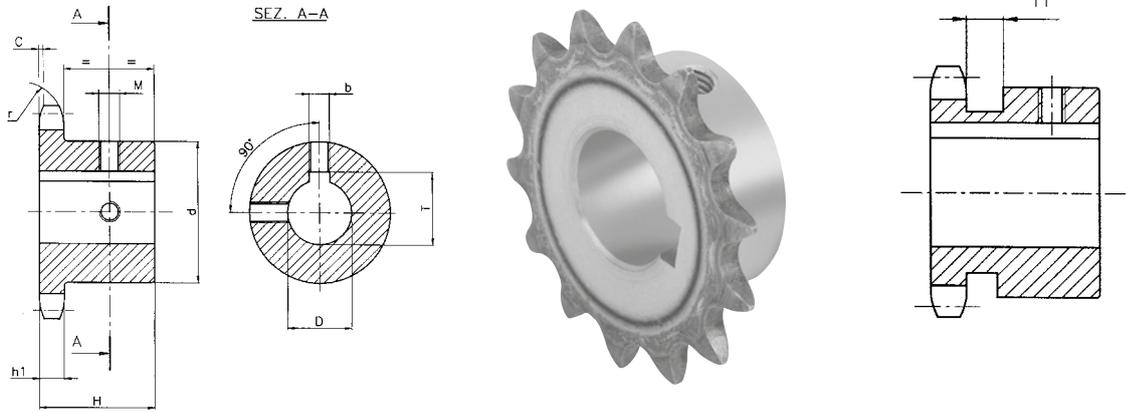

1" x 17,02 mm

Versione (\*) / Type (\*) / Typ (\*) / Tipo (\*)

**16B-1 25,4 x 17,02 mm**

DIN 8187 ISO/R606

CATENA	CHAIN	KETTE	CHAÎNE	CADENA	ISO mm
Passo	Pitch	Teilung	Pas	Paso	<b>25,40</b>
Larghezza interna	Internal width	Innere Breite	Largeur interieure	Ancho interno	<b>17,02</b>
Rullo $\varnothing$	Roller $\varnothing$	Rollen $\varnothing$	$\varnothing$ du rouleau	Rodillo $\varnothing$	<b>15,88</b>

PIGNONE	SPROCKETS	KETTENRÄDER	PIGNONS	PIÑONES	
Raggio dente r	Tooth radius r	Radius r	Rayon de denture r	Radio diente r	<b>r 26,0</b>
Larghezza raggio C	Radius width C	Breite C	Largeur de rayon C	Ancho radio C	<b>C 2,5</b>
Largh. Dente $h_1$	Tooth width $h_1$	Zahnbreite $h_1$	Larg. de denture $h_1$	Ancho diente $h_1$	<b><math>h_1</math> 16,2</b>

b-T-M pag. / page 19

Materiale C 45 E  
UNI EN 10083-1

Material C 45 E  
UNI EN 10083-1

Werkstoff C 45 E  
UNI EN 10083-1

Matière C 45 E  
UNI EN 10083-1

Material C 45 E  
UNI EN 10083-1

CODICE	Z	D	H	d	CODICE	Z	D	H	d	CODICE	Z	D	H	d	CODICE	Z	D	H	d	
12SB511	11	25	40	61	12SD015	15	40	40	92	12SD019	19	40	45	100	12SD023	23	40	50	110	
12SB811		28			12SD215		42			12SD219		42			12SD223		42			
12SC011		30			12SD515		45			12SD519		45			12SD523		45			
12SC211		32			12SD815		48			12SD819		48			12SD823		48			
12SC511		35			12SE015		50			12SE019		50			12SE023		50			
12SC811	38	65	12SB516	25	12SB520	25	12SB524	25												
12SD011	40	67	12SB816	28	12SB820	28	12SB824	28												
12SD211	42	69*	12SC016	30	12SC020	30	12SC024	30												
12SB512	12	25	40	69	12SC216	16	32	45	100	12SC220	20	32	45	100	12SC224	24	32	50	110	
12SB812		28			12SC516		35			12SC520		35			12SC524		35			
12SC012		30			12SC816		38			12SC820		38			12SC824		38			
12SC212		32			12SD016		40			12SD020		40			12SD024		40			
12SC512		35			12SD216		42			12SD220		42			12SD224		42			
12SC812	38	12SD516	45	12SD520	45	12SD524	45													
12SD012	40	12SD816	48	12SD820	48	12SD824	48													
12SD212	42	12SE016	50	12SE020	50	12SE024	50													
12SB513	13	25	40	78	12SB517	17	25	45	100	12SB521	21	25	50	110	12SB525	25	25	50	110	
12SB813		28			12SB817		28			12SB821		28			12SB825		28			
12SC013		30			12SC017		30			12SC021		30			12SC025		30			
12SC213		32			12SC217		32			12SC221		32			12SC225		32			
12SC513		35			12SC517		35			12SC521		35			12SC525		35			
12SC813	38	12SC817	38	12SC821	38	12SC825	38													
12SD013	40	12SD017	40	12SD021	40	12SD025	40													
12SD213	42	12SD217	42	12SD221	42	12SD225	42													
12SD513	45	12SD517	45	12SD521	45	12SD525	45													
12SD813	48	12SD817	48	12SD821	48	12SD825	48													
12SE013	50	12SE017	50	12SE021	50	12SE025	50													
12SB514	14	25	40	84	12SB518	18	25	45	100	12SB522	22	25	50	110						
12SB814		28			12SB818		28			12SB822		28			12SB826					28
12SC014		30			12SC018		30			12SC022		30			12SC026					30
12SC214		32			12SC218		32			12SC222		32			12SC226					32
12SC514		35			12SC518		35			12SC522		35			12SC526					35
12SC814	38	12SC818	38	12SC822	38	12SC826	38													
12SD014	40	12SD018	40	12SD022	40	12SD026	40													
12SD214	42	12SD218	42	12SD222	42	12SD226	42													
12SD514	45	12SD518	45	12SD522	45	12SD526	45													
12SD814	48	12SD818	48	12SD822	48	12SD826	48													
12SE014	50	12SE018	50	12SE022	50	12SE026	50													
12SB515	15	25	40	92	12SB519	19	25	45	100	12SB523	23	25	50	110						
12SB815		28			12SB819		28			12SB823		28			12SB827					28
12SC015		30			12SC019		30			12SC023		30			12SC027					30
12SC215		32			12SC219		32			12SC223		32			12SC227					32
12SC515		35			12SC519		35			12SC523		35			12SC527					35
12SC815	38	12SC819	38	12SC823	38	12SC827	38													

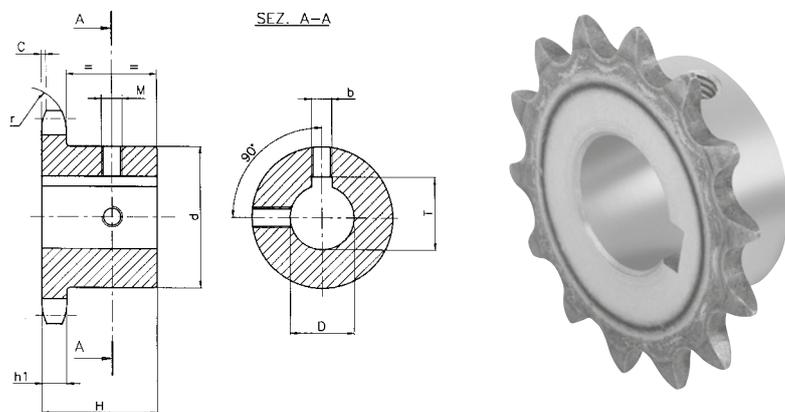

1" x 1/4 x 3/4"

20B-1 31,75 x 19,56 mm

DIN 8187 ISO/R606

CATENA	CHAIN	KETTE	CHAÎNE	CADENA	ISO mm
Passo	Pitch	Teilung	Pas	Paso	31,75
Larghezza interna	Internal width	Innere Breite	Largeur interieure	Ancho interno	19,56
Rullo $\varnothing$	Roller $\varnothing$	Rollen $\varnothing$	$\varnothing$ du rouleau	Rodillo $\varnothing$	19,05

PIGNONE	SPROCKETS	KETTENRÄDER	PIGNONS	PIÑONES	
Raggio dente r	Tooth radius r	Radius r	Rayon de denture r	Radio diente r	r 32,0
Larghezza raggio C	Radius width C	Breite C	Largeur de rayon C	Ancho radio C	C 3,5
Largh. Dente $h_1$	Tooth width $h_1$	Zahnbreite $h_1$	Larg. de denture $h_1$	Ancho diente $h_1$	$h_1$ 18,5

b-T-M pag. / page 19

Materiale C 45 E  
UNI EN 10083-1

Material C 45 E  
UNI EN 10083-1

Werkstoff C 45 E  
UNI EN 10083-1

Matière C 45 E  
UNI EN 10083-1

Material C 45 E  
UNI EN 10083-1

CODICE	Z	D	H	d	CODICE	Z	D	H	d	CODICE	Z	D	H	d	CODICE	Z	D	H	d
12SB511	11	25	40	61	12SD015	15	40	40	92	12SD019	19	40	45	100	12SD023	23	40	50	110
12SB811		28			12SD215		42			12SD219		42			12SD223		42		
12SC011		30			12SD515		45			12SD519		45			12SD523		45		
12SC211		32			12SD815		48			12SD819		48			12SD823		48		
12SC511		35			12SE015		50			12SE019		50			12SE023		50		
12SC811	12	38	40	69	12SB516	16	25	45	100	12SB520	20	25	45	100	12SB524	24	25	50	110
12SD011		40			12SB816		28			12SB820		28			12SB824		28		
12SD211		42			12SC016		30			12SC020		30			12SC024		30		
12SB512		25			12SC216		32			12SC220		32			12SC224		32		
12SB812		28			12SC516		35			12SC520		35			12SC524		35		
12SC012	30	12SC816	38	12SC820	38	12SC824	38												
12SC212	32	12SD016	40	12SD020	40	12SD024	40												
12SC512	35	12SD216	42	12SD220	42	12SD224	42												
12SC812	38	12SD516	45	12SD520	45	12SD524	45												
12SD012	40	12SD816	48	12SD820	48	12SD824	48												
12SD212	42	12SE016	50	12SE020	50	12SE024	50												
12SB513	13	25	40	78	12SB517	17	25	45	100	12SB521	21	25	50	110	12SB525	25	25	50	110
12SB813		28			12SB817		28			12SB821		28			12SB825		28		
12SC013		30			12SC017		30			12SC021		30			12SC025		30		
12SC213		32			12SC217		32			12SC221		32			12SC225		32		
12SC513		35			12SC517		35			12SC521		35			12SC525		35		
12SC813	38	12SC817	38	12SC821	38	12SC825	38												
12SD013	40	12SD017	40	12SD021	40	12SD025	40												
12SD213	42	12SD217	42	12SD221	42	12SD225	42												
12SD513	45	12SD517	45	12SD521	45	12SD525	45												
12SD813	48	12SD817	48	12SD821	48	12SD825	48												
12SE013	50	12SE017	50	12SE021	50	12SE025	50												
12SB514	14	25	40	84	12SB518	18	25	45	100	12SB522	22	25	50	110					
12SB814		28			12SB818		28			12SB822		28							
12SC014		30			12SC018		30			12SC022		30							
12SC214		32			12SC218		32			12SC222		32							
12SC514		35			12SC518		35			12SC522		35							
12SC814	38	12SC818	38	12SC822	38														
12SD014	40	12SD018	40	12SD022	40														
12SD214	42	12SD218	42	12SD222	42														
12SD514	45	12SD518	45	12SD522	45														
12SD814	48	12SD818	48	12SD822	48														
12SE014	50	12SE018	50	12SE022	50														
12SB515	15	25	40	92	12SB519	19	25	45	100	12SB523	23	25	50	110					
12SB815		28			12SB819		28			12SB823		28							
12SC015		30			12SC019		30			12SC023		30							
12SC215		32			12SC219		32			12SC223		32							
12SC515		35			12SC519		35			12SC523		35							
12SC815	38	12SC819	38	12SC823	38														



**Pignoni e corone**  
**Sprockets and plate wheels**  
**Kettenräder und Kettenradscheiben**  
**Pignons et disques**  
**Piñones y discos**

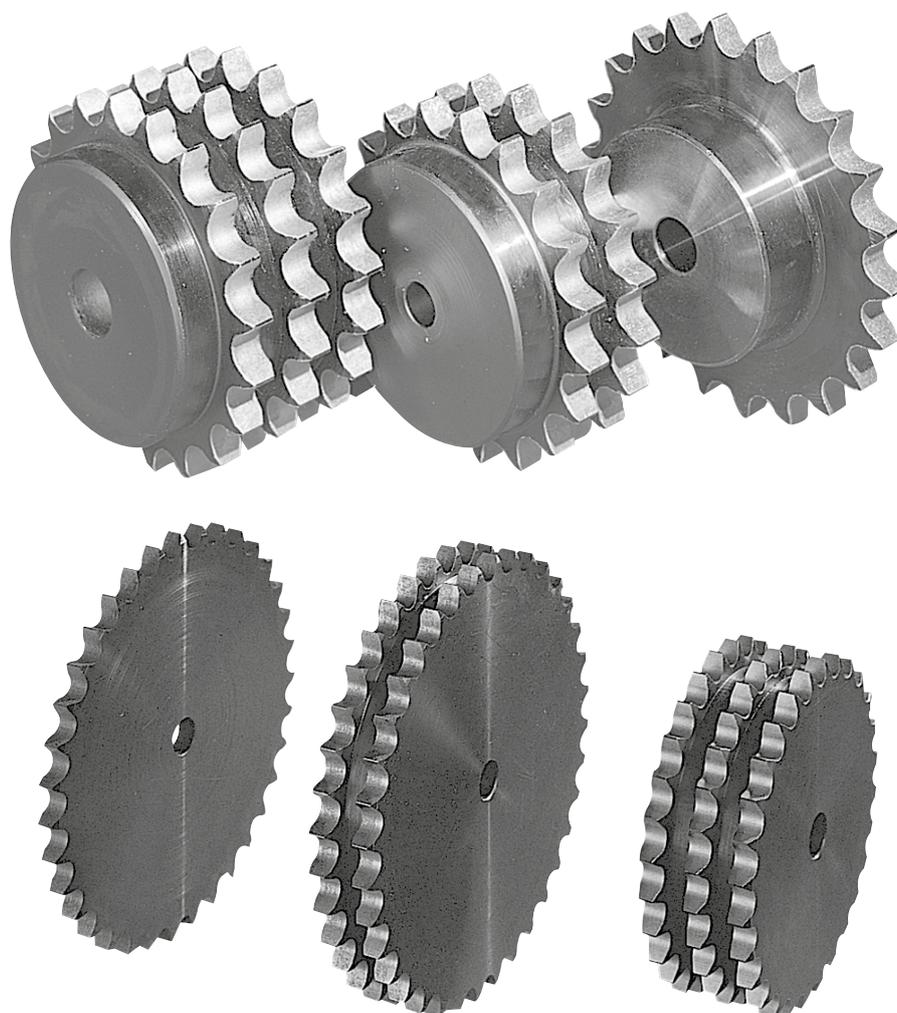

Pignoni per catene semplici,  
a rulli secondo: DIN 8187 -  
ISO/R 606

Sprockets for simplex, chain  
to: DIN 8187 - ISO/R 606

Kettenräder mit einseitiger  
Nabe für Simplex-Rollenkette  
nach: DIN 8187 - ISO/R 606

Pignons avec moyeu déporté  
pour chaînes simples, à  
rouleaux suivant les normes:  
DIN 8187 - ISO/R 606

Piñones para cadena simple,  
de rodillos según las normas:  
DIN 8187 - ISO/R 606

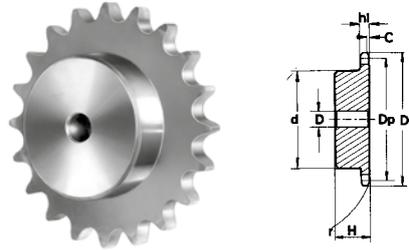

## 5 x 2,5 mm

## 03 - 1

CATENA	CHAIN	KETTE	CHAÎNE	CADENA	ISO mm
Passo	Pitch	Teilung	Pas	Paso	<b>5,0</b>
Larghezza interna	Internal width	Innere Breite	Largeur interieure	Ancho interno	<b>2,5</b>
Rullo $\varnothing$	Roller $\varnothing$	Rollen $\varnothing$	$\varnothing$ du rouleau	Rodillo $\varnothing$	<b>3,2</b>

PIGNONE	SPROCKETS	KETTENRÄDER	PIGNONS	PIÑONES	ISO mm
Raggio dente r	Tooth radius r	Radius r	Rayon de denture r	Radio diente r	<b>r</b> <b>5,0</b>
Larghezza raggio C	Radius width C	Breite C	Largeur de rayon C	Ancho radio C	<b>C</b> <b>0,6</b>
Largh. dente $h_1$	Tooth width $h_1$	Zahnbreite $h_1$	Larg. de denture $h_1$	Ancho diente $h_1$	<b>h<sub>1</sub></b> <b>2,3</b>
Largh. dente L	Tooth width L	Zahnbreite L	Larg. de denture L	Ancho diente L	<b>L</b> -
Largh. dente $h_2$	Tooth width $h_2$	Zahnbreite $h_2$	Larg. de denture $h_2$	Ancho diente $h_2$	<b>h<sub>2</sub></b> -
Largh. dente $h_3$	Tooth width $h_3$	Zahnbreite $h_3$	Larg. de denture $h_3$	Ancho diente $h_3$	<b>h<sub>3</sub></b> -
Altezza totale H	Full height H	Gesamt Höhe H	Hauteur totale H	Altura total H	<b>H</b> -

**Materiale C 45 E**  
**UNI EN 10083-1**

**Material C 45 E**  
**UNI EN 10083-1**

**Werkstoff C 45 E**  
**UNI EN 10083-1**

**Matière C 45 E**  
**UNI EN 10083-1**

**Material C 45 E**  
**UNI EN 10083-1**

Z	D <sub>e</sub>	D <sub>p</sub>	PS			
			cod.	d	D	H
8	15,2	13,06	PS 01008	7	4	10
9	16,8	14,62	PS 01009	8	5	10
10	18,3	16,18	PS 01010	9	5	10
11	19,9	17,75	PS 01011	11	6	10
12	21,5	19,32	PS 01012	12	6	10
13	23,0	20,89	PS 01013	14	6	10
14	24,6	22,47	PS 01014	15	6	10
15	26,2	24,04	PS 01015	16	6	10
16	27,8	25,63	PS 01016	18	8	13
17	29,4	27,20	PS 01017	18	8	13
18	30,9	28,79	PS 01018	18	8	13
19	32,5	30,38	PS 01019	18	8	13
20	34,1	31,96	PS 01020	18	8	13
21	35,7	33,54	PS 01021	20	8	13
22	37,3	35,13	PS 01022	20	8	13
23	38,9	36,72	PS 01023	20	8	13
24	40,5	38,30	PS 01024	20	8	13
25	42,0	39,89	PS 01025	20	8	13
26	43,6	41,48	PS 01026	25	8	15
27	45,2	43,07	PS 01027	25	8	15
28	46,8	44,65	PS 01028	25	8	15
29	48,4	46,25	PS 01029	25	8	15
30	50,0	47,83	PS 01030	25	8	15
31	51,6	49,42	PS 01031	30	8	15
32	53,2	51,01	PS 01032	30	8	15
33	54,8	52,60	PS 01033	30	8	15
34	56,3	54,19	PS 01034	30	8	15
35	57,9	55,78	PS 01035	30	8	15
36	59,5	57,37	PS 01036	30	8	15
37	61,1	58,96	PS 01037	30	8	15
38	62,7	60,54	PS 01038	30	8	15
39	64,3	62,13	PS 01039	30	8	15
40	65,9	63,73	PS 01040	30	8	15

Pignoni per catene semplici,  
a rulli secondo: DIN 8187 -  
ISO/R 606

Sprockets for simplex, chain  
to: DIN 8187 - ISO/R 606

Kettenräder mit einseitiger  
Nabe für Simplex-Rollenkette  
nach: DIN 8187 - ISO/R 606

Pignons avec moyeu déporté  
pour chaînes simples, à  
rouleaux suivant les normes:  
DIN 8187 - ISO/R 606

Piñones para cadena simple,  
de rodillos según las normas:  
DIN 8187 - ISO/R 606

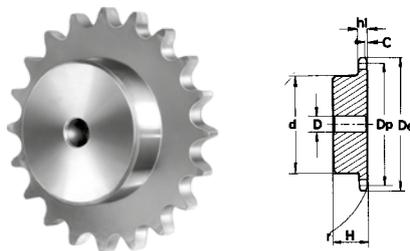

**6 x 2,8 mm**

**04 - 1**

CATENA	CHAIN	KETTE	CHAÎNE	CADENA	ISO mm
Passo	Pitch	Teilung	Pas	Paso	<b>6,0</b>
Larghezza interna	Internal width	Innere Breite	Largeur interieure	Ancho interno	<b>2,8</b>
Rullo $\varnothing$	Roller $\varnothing$	Rollen $\varnothing$	$\varnothing$ du rouleau	Rodillo $\varnothing$	<b>4,0</b>

PIGNONE	SPROCKETS	KETTENRÄDER	PIGNONS	PIÑONES	ISO mm
Raggio dente r	Tooth radius r	Radius r	Rayon de denture r	Radio diente r	<b>r</b> <b>6,0</b>
Larghezza raggio C	Radius width C	Breite C	Largeur de rayon C	Ancho radio C	<b>C</b> <b>0,7</b>
Largh. dente $h_1$	Tooth width $h_1$	Zahnbreite $h_1$	Larg. de denture $h_1$	Ancho diente $h_1$	<b><math>h_1</math></b> <b>2,6</b>
Largh. dente L	Tooth width L	Zahnbreite L	Larg. de denture L	Ancho diente L	<b>L</b> -
Largh. dente $h_2$	Tooth width $h_2$	Zahnbreite $h_2$	Larg. de denture $h_2$	Ancho diente $h_2$	<b><math>h_2</math></b> -
Largh. dente $h_3$	Tooth width $h_3$	Zahnbreite $h_3$	Larg. de denture $h_3$	Ancho diente $h_3$	<b><math>h_3</math></b> -
Altezza totale H	Full height H	Gesamt Höhe H	Hauteur totale H	Altura total H	<b>H</b> -

**Materiale C 45 E**  
**UNI EN 10083-1**

\*Tipi costruiti con mozzo saldato:  
materiale Fe

**Material C 45 E**  
**UNI EN 10083-1**

\*With welded hub:  
material Fe

**Werkstoff C 45 E**  
**UNI EN 10083-1**

\*Typen mit eingeschweisster  
Nabe: Werkstoff Fe

**Matière C 45 E**  
**UNI EN 10083-1**

\*Tipos avec moyeu soudé:  
matière Fe

**Material C 45 E**  
**UNI EN 10083-1**

\*Tipos con nucleo soldado:  
material Fe

Z	D <sub>e</sub>	D <sub>p</sub>	PS			
			cod.	d	D	H
8	18,0	15,67	PS 02008	9,8	5	10
9	19,9	17,54	PS 02009	11,5	5	10
10	21,7	19,42	PS 02010	13,0	6	10
11	23,6	21,30	PS 02011	14,0	6	10
12	25,4	23,18	PS 02012	16,0	6	10
13	27,3	25,05	PS 02013	18,0	8	10
14	29,2	26,96	PS 02014	20,0	8	10
15	31,1	28,86	PS 02015	20,0	8	10
16	33,0	30,76	PS 02016	20,0	8	13
17	35,0	32,65	PS 02017	20,0	8	13
18	36,9	34,55	PS 02018	20,0	8	13
19	38,8	36,44	PS 02019	20,0	8	13
20	40,7	38,34	PS 02020	20,0	8	13
21	42,6	40,25	PS 02021	25,0	8	13
22	44,5	42,16	PS 02022	25,0	8	13
23	46,4	44,06	PS 02023	25,0	8	13
24	48,3	45,96	PS 02024	25,0	8	13
25	50,2	47,87	PS 02025	25,0	8	13
26	52,1	49,77	PS 02026	30,0	8	15
27	54,0	51,67	PS 02027	30,0	8	15
28	55,9	53,58	PS 02028	30,0	8	15
29	57,8	55,50	PS 02029	30,0	8	15
30	59,8	57,42	PS 02030	30,0	8	15
31	61,7	59,31	PS 02031	30,0	8	15
32	63,6	61,21	PS 02032	30,0	8	15
33	65,5	63,11	PS 02033	30,0	8	15
34	67,4	65,02	PS 02034	30,0	8	15
35	69,3	66,93	PS 02035	30,0	8	15
36	71,2	68,84	PS 02036	30,0	8	15
37	73,1	70,75	PS 02037	30,0	8	15
38	75,0	72,66	PS 02038	30,0	8	15
39	76,9	74,56	PS 02039	30,0	8	15
40	78,9	76,47	PS 02040	30,0	8	15
45	88,5	86,01	PS 02045	40,0	10	18
50	98,0	95,55	PS 02050	50,0	12	20
57	111,4	108,93	PS 02057	50,0	12	20
60	117,1	114,62	PS 02060	62,0*	12	20
76	147,6	145,19	PS 02076	80,0*	16	34

Pignoni per catene semplici,  
a rulli secondo: DIN 8188 -  
ISO/R 606 - ANSI B 29,1

Sprockets for simplex chain  
to: DIN 8188 - ISO/R 606 -  
ANSI B 29,1

Kettenräder mit einseitiger  
Nabe für Simplex-Rollenkette  
nach: DIN 8188 - ISO/R 606 -  
ANSI B 29,1

Pignons avec moyeu déporté  
pour chaînes simples à rouleaux  
suivant les normes: DIN 8188 -  
ISO/R 606 - ANSI B 29,1

Piñones para cadena simple de  
rodillos según las normas: DIN  
8188 - ISO/R 606 - ANSI B 29,1

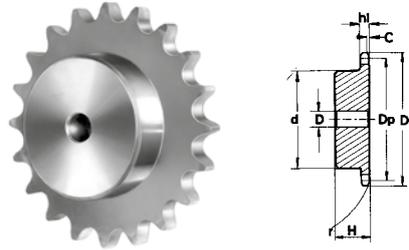

**1/4" x 1/8"**

**ASA 25 - 1 6,32 x 3,18 mm**

CATENA	CHAIN	KETTE	CHAÎNE	CADENA	ASA 25 mm
Passo	Pitch	Teilung	Pas	Paso	<b>6,35</b>
Larghezza interna	Internal width	Innere Breite	Largeur interieure	Ancho interno	<b>3,18</b>
Rullo $\varnothing$	Roller $\varnothing$	Rollen $\varnothing$	$\varnothing$ du rouleau	Rodillo $\varnothing$	<b>3,30</b>

PIGNONE	SPROCKETS	KETTENRÄDER	PIGNONS	PIÑONES	ASA 25 mm
Raggio dente r	Tooth radius r	Radius r	Rayon de denture r	Radio diente r	<b>r 6,4</b>
Larghezza raggio C	Radius width C	Breite C	Largeur de rayon C	Ancho radio C	<b>C 0,7</b>
Largh. dente $h_1$	Tooth width $h_1$	Zahnbreite $h_1$	Larg. de denture $h_1$	Ancho diente $h_1$	<b><math>h_1</math> 2,9</b>
Largh. dente L	Tooth width L	Zahnbreite L	Larg. de denture L	Ancho diente L	<b>L -</b>
Largh. dente $h_2$	Tooth width $h_2$	Zahnbreite $h_2$	Larg. de denture $h_2$	Ancho diente $h_2$	<b><math>h_2</math> -</b>
Largh. dente $h_3$	Tooth width $h_3$	Zahnbreite $h_3$	Larg. de denture $h_3$	Ancho diente $h_3$	<b><math>h_3</math> -</b>
Altezza totale H	Full height H	Gesamt Höhe H	Hauteur totale H	Altura total H	<b>H -</b>

**Materiale C 45 E  
UNI EN 10083-1**

**Material C 45 E  
UNI EN 10083-1**

**Werkstoff C 45 E  
UNI EN 10083-1**

**Matière C 45 E  
UNI EN 10083-1**

**Material C 45 E  
UNI EN 10083-1**

Z	D <sub>e</sub>	D <sub>p</sub>	PS			
			cod.	d	D	H
8	19,4	16,58	PS 03008	10,0	6	12
9	21,4	18,56	PS 03009	11,5	6	12
10	23,3	20,55	PS 03010	13,0	6	12
11	25,3	22,54	PS 03011	15,0	8	13
12	27,3	24,53	PS 03012	17,0	8	13
13	29,3	26,53	PS 03013	17,0	8	13
14	31,3	28,53	PS 03014	17,0	8	13
15	33,3	30,55	PS 03015	20,0	8	13
16	35,3	32,55	PS 03016	22,0	8	14
17	37,3	34,55	PS 03017	22,0	8	14
18	39,4	36,56	PS 03018	25,0	8	14
19	41,4	38,58	PS 03019	25,0	8	14
20	43,4	40,58	PS 03020	25,0	8	14
21	45,4	42,60	PS 03021	30,0	8	14
22	47,4	44,62	PS 03022	30,0	8	14
23	49,4	46,63	PS 03023	30,0	8	14
24	51,4	48,64	PS 03024	30,0	8	14
25	53,3	50,66	PS 03025	30,0	8	14
26	55,5	52,67	PS 03026	30,0	8	16
27	57,5	54,69	PS 03027	30,0	8	16
28	59,5	56,71	PS 03028	30,0	8	16
29	61,5	58,73	PS 03029	30,0	8	16
30	63,6	60,75	PS 03030	30,0	8	16
31	65,6	62,76	PS 03031	30,0	8	16
32	67,6	64,78	PS 03032	30,0	8	16
33	69,6	66,80	PS 03033	30,0	8	16
34	71,6	68,82	PS 03034	30,0	8	16
35	73,6	70,84	PS 03035	30,0	8	16
36	75,6	72,85	PS 03036	30,0	8	16
37	77,7	74,87	PS 03037	30,0	8	16
38	79,7	76,89	PS 03038	30,0	8	16
39	81,7	78,91	PS 03039	30,0	8	16
40	83,7	80,93	PS 03040	30,0	8	16



Pignoni per catene semplici e doppie a rulli secondo: DIN 8187 - ISO/R 606

Sprockets for simplex and duplex chain to: DIN 8187 - ISO/R 606

Kettenräder mit einseitiger Nabe für Simplex-Rollenkette Duplex-Rollenkette nach: DIN 8187 - ISO/R 606

Pignons avec moyeu déporté pour chaînes simples et doubles à rouleaux suivant les normes: DIN 8187 - ISO/R 606

Piñones para cadena simple y doble de rodillos según las normas: DIN 8187 - ISO/R 606

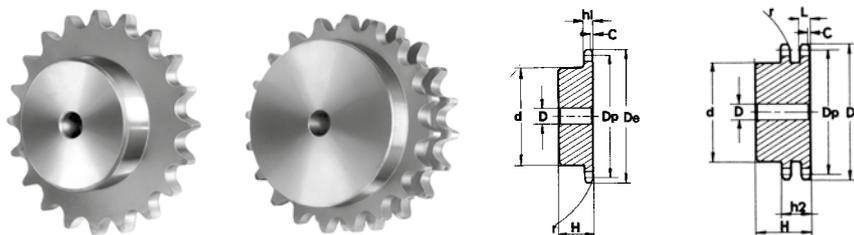

**8 x 3,0 mm**

**05B - 1-2**

CATENA	CHAIN	KETTE	CHAÎNE	CADENA	ISO mm
Passo	Pitch	Teilung	Pas	Paso	<b>8,0</b>
Larghezza interna	Internal width	Innere Breite	Largeur interieure	Ancho interno	<b>3,0</b>
Rullo $\varnothing$	Roller $\varnothing$	Rollen $\varnothing$	$\varnothing$ du rouleau	Rodillo $\varnothing$	<b>5,0</b>

PIGNONE	SPROCKETS	KETTENRÄDER	PIGNONS	PIÑONES	ISO mm
Raggio dente r	Tooth radius r	Radius r	Rayon de denture r	Radio diente r	<b>8,0</b>
Larghezza raggio C	Radius width C	Breite C	Largeur de rayon C	Ancho radio C	<b>1,0</b>
Largh. dente $h_1$	Tooth width $h_1$	Zahnbreite $h_1$	Larg. de denture $h_1$	Ancho diente $h_1$	<b>2,8</b>
Largh. dente L	Tooth width L	Zahnbreite L	Larg. de denture L	Ancho diente L	<b>2,7</b>
Largh. dente $h_2$	Tooth width $h_2$	Zahnbreite $h_2$	Larg. de denture $h_2$	Ancho diente $h_2$	<b>8,3</b>
Largh. dente $h_3$	Tooth width $h_3$	Zahnbreite $h_3$	Larg. de denture $h_3$	Ancho diente $h_3$	-
Altezza totale H	Full height H	Gesamt Höhe H	Hauteur totale H	Altura total H	-

**Materiale C 45 E**

**UNI EN 10083-1**

\*Tipi costruiti con mozzo saldato: materiale Fe

**Material C 45 E**

**UNI EN 10083-1**

\*With welded hub: material Fe

**Werkstoff C 45 E**

**UNI EN 10083-1**

\*Typen mit eingeschweisster Nabe: Werkstoff Fe

**Matière C 45 E**

**UNI EN 10083-1**

\*Tipos avec moyeu soudé: matière Fe

**Material C 45 E**

**UNI EN 10083-1**

\*Tipos con nucleo soldado: material Fe

Z	D <sub>e</sub>	D <sub>p</sub>	PS				PD			
			cod.	d	D	H	cod.	d	D	H
8	24,0	20,90	PS 04008	13	6	12	PD 04008	12	8	18
9	26,6	23,39	PS 04009	15	6	12	PD 04009	15	8	18
10	29,2	25,89	PS 04010	17	8	12	PD 04010	17	8	18
11	31,7	28,39	PS 04011	18	8	13	PD 04011	19	10	18
12	34,2	30,91	PS 04012	20	8	13	PD 04012	21	10	18
13	36,7	33,42	PS 04013	23	8	13	PD 04013	24	10	18
14	39,2	35,95	PS 04014	25	8	13	PD 04014	26	10	18
15	41,7	38,48	PS 04015	28	8	13	PD 04015	29	10	18
16	44,3	41,01	PS 04016	30	8	14	PD 04016	32	10	20
17	46,8	43,53	PS 04017	30	8	14	PD 04017	34	10	20
18	49,3	46,07	PS 04018	30	8	14	PD 04018	37	10	20
19	51,9	48,61	PS 04019	30	8	14	PD 04019	39	10	20
20	54,4	51,14	PS 04020	30	8	14	PD 04020	40	10	20
21	57,0	53,67	PS 04021	35	8	14	PD 04021	40	10	20
22	59,5	56,21	PS 04022	35	8	14	PD 04022	40	10	20
23	62,0	58,75	PS 04023	35	8	14	PD 04023	40	10	20
24	64,6	61,29	PS 04024	35	8	14	PD 04024	40	10	20
25	67,5	63,83	PS 04025	35	8	14	PD 04025	40	10	20
26	69,5	66,37	PS 04026	40	10	16	PD 04026	50	12	22
27	72,2	68,91	PS 04027	40	10	16	PD 04027	50	12	22
28	74,8	71,45	PS 04028	40	10	16	PD 04028	50	12	22
29	77,3	73,99	PS 04029	40	10	16	PD 04029	50	12	22
30	79,8	76,53	PS 04030	40	10	16	PD 04030	50	12	22
31	82,4	79,08	PS 04031	40	10	16	PD 04031	60	12	22
32	84,9	81,61	PS 04032	40	10	16	PD 04032	60	12	22
33	87,5	84,16	PS 04033	40	10	16	PD 04033	60	12	22
34	90,0	86,70	PS 04034	40	10	16	PD 04034	60	12	22
35	92,5	89,24	PS 04035	40	10	16	PD 04035	60	12	22
36	95,0	91,79	PS 04036	40	10	16	PD 04036	60	12	22
37	97,6	94,33	PS 04037	40	10	16	PD 04037	60	12	22
38	100,2	96,88	PS 04038	40	10	16	PD 04038	60	12	22
39	102,7	99,42	PS 04039	40	10	16	PD 04039	60	12	22
40	105,2	101,97	PS 04040	40	10	16	PD 04040	60	12	22
45	118,0	114,69	PS 04045	60	12	20				
48	125,6	122,32	PS 04048	62*	12	20				
50	130,7	127,41	PS 04050	62*	12	20				
57	148,6	145,22	PS 04057	80*	14	20				
60	156,2	152,85	PS 04060	80*	16	34				
76	197,7	193,59	PS 04076	80*	20	34				

Pignoni per catene semplici, doppie e triple a rulli secondo: DIN 8187 - ISO/R 606

Sprockets for simplex, duplex and triplex chain to: DIN 8187 - ISO/R 606

Kettenräder mit einseitiger Nabe für Simplex- Duplex- Triplex-Rollenkette nach: DIN 8187 - ISO/R 606

Pignons avec moyeu déporté pour chaînes simples, doubles et triples à rouleaux suivant les normes: DIN 8187 - ISO/R 606

Piñones para cadena simple, doble y triple de rodillos según las normas: DIN 8187 - ISO/R 606

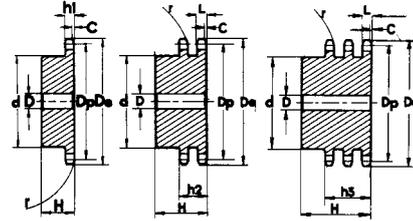

## 3/8" x 7/32"

## 06B - 1-2-3 9,525 x 5,72 mm

CATENA	CHAIN	KETTE	CHAÎNE	CADENA	ISO mm
Passo	Pitch	Teilung	Pas	Paso	<b>9,525</b>
Larghezza interna	Internal width	Innere Breite	Largeur interieure	Ancho interno	<b>5,720</b>
Rullo $\varnothing$	Roller $\varnothing$	Rollen $\varnothing$	$\varnothing$ du rouleau	Rodillo $\varnothing$	<b>6,350</b>

PIGNONE	SPROCKETS	KETTENRÄDER	PIGNONS	PIÑONES	ISO mm
Raggio dente r	Tooth radius r	Radius r	Rayon de denture r	Radio diente r	<b>10,0</b>
Larghezza raggio C	Radius width C	Breite C	Largeur de rayon C	Ancho radio C	<b>1,0</b>
Largh. dente $h_1$	Tooth width $h_1$	Zahnbreite $h_1$	Larg. de denture $h_1$	Ancho diente $h_1$	<b>5,3</b>
Largh. dente L	Tooth width L	Zahnbreite L	Larg. de denture L	Ancho diente L	<b>5,2</b>
Largh. dente $h_2$	Tooth width $h_2$	Zahnbreite $h_2$	Larg. de denture $h_2$	Ancho diente $h_2$	<b>15,4</b>
Largh. dente $h_3$	Tooth width $h_3$	Zahnbreite $h_3$	Larg. de denture $h_3$	Ancho diente $h_3$	<b>25,6</b>
Altezza totale H	Full height H	Gesamt Höhe H	Hauteur totale H	Altura total H	<b>-</b>

**Materiale C 45 E**  
**UNI EN 10083-1**

\*Tipi costruiti con mozzo saldato: materiale Fe

**Material C 45 E**  
**UNI EN 10083-1**

\*With welded hub: material Fe

**Werkstoff C 45 E**  
**UNI EN 10083-1**

\*Typen mit eingeschweisster Nabe: Werkstoff Fe

**Matière C 45 E**  
**UNI EN 10083-1**

\*Tipos avec moyeu soudé: matière Fe

**Material C 45 E**  
**UNI EN 10083-1**

\*Tipos con nucleo soldado: material Fe

Z	$D_e$	$D_p$	PS				PD				PT			
			cod.	d	D	H	cod.	d	D	H	cod.	d	D	H
8	28,0	24,89	PS 05008	15	8	22	PD 05008	15	6	22	PT 05008	15	6	32
9	31,0	27,85	PS 05009	18	8	22	PD 05009	18	8	22	PT 05009	18	8	32
10	34,0	30,82	PS 05010	20	8	22	PD 05010	20	8	22	PT 05010	20	10	32
11	37,0	33,80	PS 05011	22	8	25	PD 05011	22	10	25	PT 05011	22	10	35
12	40,0	36,80	PS 05012	25	8	25	PD 05012	25	10	25	PT 05012	25	10	35
13	43,0	39,80	PS 05013	28	10	25	PD 05013	28	10	25	PT 05013	28	10	35
14	46,3	42,80	PS 05014	31	10	25	PD 05014	31	10	25	PT 05014	31	12	35
15	49,3	45,81	PS 05015	34	10	25	PD 05015	34	10	25	PT 05015	34	12	35
16	52,3	48,82	PS 05016	37	10	28	PD 05016	37	12	30	PT 05016	37	12	35
17	55,3	51,83	PS 05017	40	10	28	PD 05017	40	12	30	PT 05017	40	12	35
18	58,3	54,85	PS 05018	43	10	28	PD 05018	43	12	30	PT 05018	43	12	35
19	61,3	57,87	PS 05019	45	10	28	PD 05019	46	12	30	PT 05019	46	12	35
20	64,3	60,89	PS 05020	46	10	28	PD 05020	49	12	30	PT 05020	49	12	35
21	68,0	63,91	PS 05021	48	12	28	PD 05021	52	12	30	PT 05021	52	14	40
22	71,0	66,93	PS 05022	50	12	28	PD 05022	55	12	30	PT 05022	55	14	40
23	73,5	69,95	PS 05023	52	12	28	PD 05023	58	12	30	PT 05023	58	14	40
24	77,0	72,97	PS 05024	54	12	28	PD 05024	61	12	30	PT 05024	61	14	40
25	80,0	76,00	PS 05025	57	12	28	PD 05025	64	12	30	PT 05025	64	14	40
26	83,0	79,02	PS 05026	60	12	28	PD 05026	67	12	30	PT 05026	67	14	40
27	86,0	82,04	PS 05027	60	12	28	PD 05027	70	12	30	PT 05027	70	14	40
28	89,0	85,07	PS 05028	60	12	28	PD 05028	73	12	30	PT 05028	73	14	40
29	92,0	88,09	PS 05029	60	12	28	PD 05029	76	12	30	PT 05029	76	14	40
30	94,7	91,12	PS 05030	60	12	30	PD 05030	79	12	30	PT 05030	79	14	40
31	98,3	94,15	PS 05031	65	14	30	PD 05031	80	16	30	PT 05031	80	16	40
32	101,3	97,17	PS 05032	65	14	30	PD 05032	80	16	30	PT 05032	80	16	40
33	104,3	100,20	PS 05033	65	14	30	PD 05033	80	16	30	PT 05033	80	16	40
34	107,3	103,23	PS 05034	65	14	30	PD 05034	80	16	30	PT 05034	85	16	40
35	110,4	106,26	PS 05035	65	14	30	PD 05035	80	16	30	PT 05035	85	16	40
36	113,4	109,29	PS 05036	70	16	30	PD 05036	90	16	30	PT 05036	90	16	40
37	116,4	112,32	PS 05037	70	16	30	PD 05037	90	16	30	PT 05037	90	16	40
38	119,5	115,34	PS 05038	70	16	30	PD 05038	90	16	30	PT 05038	90	16	40
39	122,5	118,37	PS 05039	70	16	30	PD 05039	90	16	30	PT 05039	90	16	40
40	125,5	121,40	PS 05040	70	16	30	PD 05040	90	16	30	PT 05040	90	16	40
42	131,6	127,46	PS 05042	78*	16	35	PD 05042	88*	20	50				
45	140,7	136,54	PS 05045	78*	16	35	PD 05045	88*	20	50	PT 05045	88*	20	60
46	143,7	139,58	PS 05046	78*	16	35								
48	149,7	145,64	PS 05048	78*	16	35	PD 05048	88*	20	50	PT 05048	88*	20	60
50	155,7	151,69	PS 05050	78*	20	35	PD 05050	88*	20	50	PT 05050	88*	20	60
55	170,8	166,85	PS 05055	78*	20	35								
57	176,9	172,91	PS 05057	78*	20	35	PD 05057	88*	20	50	PT 05057	88*	25	60
60	186,0	181,99	PS 05060	78*	20	35	PD 05060	88*	20	50	PT 05060	88*	25	60
76	234,9	230,49	PS 05076	78*	20	35	PD 05076	88*	25	50	PT 05076	88*	25	60
95	292,5	288,08	PS 05095	88*	25	40	PD 05095	108*	25	50	PT 05060	120*	25	60

Pignoni per catene semplici,  
a rulli secondo: DIN 8187 -  
ISO/R 606

Sprockets for simplex chain  
to: DIN 8187 - ISO/R 606

Kettenräder mit einseitiger  
Nabe für Simplex-Rollenkette  
nach: DIN 8187 - ISO/R 606

Pignons avec moyeu déporté  
pour chaînes simples à  
rouleaux suivant les normes:  
DIN 8187 - ISO/R 606

Piñones para cadena simple  
de rodillos según las normas:  
DIN 8187 - ISO/R 606

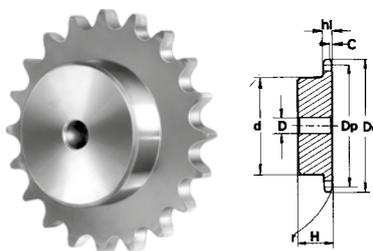

**1/2" x 1/8"**

**081-1 12,7 x 3,33 mm**

CATENA	CHAIN	KETTE	CHAÎNE	CADENA	ISO mm
Passo	Pitch	Teilung	Pas	Paso	<b>12,70</b>
Larghezza interna	Internal width	Innere Breite	Largeur interieure	Ancho interno	<b>3,30</b>
Rullo $\varnothing$	Roller $\varnothing$	Rollen $\varnothing$	$\varnothing$ du rouleau	Rodillo $\varnothing$	<b>7,75</b>

PIGNONE	SPROCKETS	KETTENRÄDER	PIGNONS	PIÑONES	ISO mm
Raggio dente r	Tooth radius r	Radius r	Rayon de denture r	Radio diente r	<b>r 13,0</b>
Larghezza raggio C	Radius width C	Breite C	Largeur de rayon C	Ancho radio C	<b>C 1,0</b>
Largh. dente $h_1$	Tooth width $h_1$	Zahnbreite $h_1$	Larg. de denture $h_1$	Ancho diente $h_1$	<b><math>h_1</math> 3,0</b>
Largh. dente L	Tooth width L	Zahnbreite L	Larg. de denture L	Ancho diente L	<b>L -</b>
Largh. dente $h_2$	Tooth width $h_2$	Zahnbreite $h_2$	Larg. de denture $h_2$	Ancho diente $h_2$	<b><math>h_2</math> -</b>
Largh. dente $h_3$	Tooth width $h_3$	Zahnbreite $h_3$	Larg. de denture $h_3$	Ancho diente $h_3$	<b><math>h_3</math> -</b>
Altezza totale H	Full height H	Gesamt Höhe H	Hauteur totale H	Altura total H	<b>H -</b>

**Materiale C 45 E**  
**UNI EN 10083-1**  
**A partire da Z = 31 il disco**  
**ruota viene maggiorato,**  
**L = 5 mm**

**Material C 45 E**  
**UNI EN 10083-1**  
**From Z = 31 the width of**  
**the plate is increased,**  
**L = 5 mm**

**Werkstoff C 45 E**  
**UNI EN 10083-1**  
**Ab Zähnezahl Z = 31**  
**beträgt die Scheibendicke**  
**L = 5 mm**

**Matière C 45 E**  
**UNI EN 10083-1**  
**A partir de Z = 31 l'e-**  
**paisseur du disque est**  
**augmenté L = 5 mm**

**Material C 45 E**  
**UNI EN 10083-1**  
**A partir de Z = 31 el disco**  
**rueda para cadena queda**  
**aumentado, L = 5 mm**

Z	D <sub>e</sub>	D <sub>p</sub>	PS			
			cod.	d	D	H
8	37,2	33,18	PS 06008	21	8	14
9	41,5	37,13	PS 06009	25	8	14
10	46,2	41,10	PS 06010	28	8	14
11	49,6	45,07	PS 06011	31	8	16
12	53,9	49,07	PS 06012	35	8	16
13	58,4	53,06	PS 06013	39	8	16
14	62,8	57,07	PS 06014	43	8	16
15	66,8	61,09	PS 06015	47	8	16
16	70,9	65,10	PS 06016	50	10	18
17	74,9	69,11	PS 06017	50	10	18
18	78,9	73,14	PS 06018	50	10	18
19	82,9	77,16	PS 06019	50	10	18
20	86,9	81,19	PS 06020	50	10	18
21	91,0	85,22	PS 06021	60	12	20
22	95,0	89,24	PS 06022	60	12	20
23	99,0	93,27	PS 06023	60	12	20
24	103,0	97,29	PS 06024	60	12	20
25	107,1	101,33	PS 06025	60	12	20
26	111,2	105,36	PS 06026	70	16	20
27	115,4	109,40	PS 06027	70	16	20
28	119,4	113,42	PS 06028	70	16	20
29	123,4	117,46	PS 06029	70	16	20
30	127,5	121,50	PS 06030	70	16	20
31	131,5	125,54	PS 06031	70	16	20
32	135,5	129,56	PS 06032	70	16	20
33	139,6	133,60	PS 06033	70	16	20
34	143,6	137,64	PS 06034	70	16	20
35	147,6	141,68	PS 06035	70	16	20
36	151,7	145,72	PS 06036	70	16	25
37	155,7	149,76	PS 06037	70	16	25
38	159,8	153,80	PS 06038	70	16	25
39	163,8	157,83	PS 06039	70	16	25
40	167,8	161,87	PS 06040	70	16	25

Pignoni per catene semplici,  
a rulli secondo: DIN 8187 -  
ISO/R 606

Sprockets for simplex chain  
to: DIN 8187 - ISO/R 606

Kettenräder mit einseitiger  
Nabe für Simplex-Rollenkette  
nach: DIN 8187 - ISO/R 606

Pignons avec moyeu déporté  
pour chaînes simples à rouleaux  
suivant les normes: DIN 8187 -  
ISO/R 606

Piñones para cadena simple  
de rodillos según las normas:  
DIN 8187 - ISO/R 606

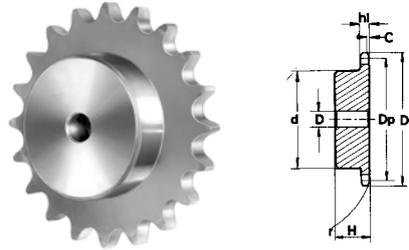

**1/2" x 3/16"**

**083-1/084-1 12,7 x 4,88 mm**

CATENA	CHAIN	KETTE	CHAÎNE	CADENA	ISO mm
Passo	Pitch	Teilung	Pas	Paso	<b>12,70</b>
Larghezza interna	Internal width	Innere Breite	Largeur interieure	Ancho interno	<b>4,88</b>
Rullo $\varnothing$	Roller $\varnothing$	Rollen $\varnothing$	$\varnothing$ du rouleau	Rodillo $\varnothing$	<b>7,75</b>

PIGNONE	SPROCKETS	KETTENRÄDER	PIGNONS	PIÑONES	ISO mm
Raggio dente r	Tooth radius r	Radius r	Rayon de denture r	Radio diente r	<b>r 13,0</b>
Larghezza raggio C	Radius width C	Breite C	Largeur de rayon C	Ancho radio C	<b>C 1,3</b>
Largh. dente $h_1$	Tooth width $h_1$	Zahnbreite $h_1$	Larg. de denture $h_1$	Ancho diente $h_1$	<b><math>h_1</math> 4,5</b>
Largh. dente L	Tooth width L	Zahnbreite L	Larg. de denture L	Ancho diente L	<b>L -</b>
Largh. dente $h_2$	Tooth width $h_2$	Zahnbreite $h_2$	Larg. de denture $h_2$	Ancho diente $h_2$	<b><math>h_2</math> -</b>
Largh. dente $h_3$	Tooth width $h_3$	Zahnbreite $h_3$	Larg. de denture $h_3$	Ancho diente $h_3$	<b><math>h_3</math> -</b>
Altezza totale H	Full height H	Gesamt Höhe H	Hauteur totale H	Altura total H	<b>H -</b>

**Materiale C 45 E  
UNI EN 10083-1**

**Material C 45 E  
UNI EN 10083-1**

**Werkstoff C 45 E  
UNI EN 10083-1**

**Matière C 45 E  
UNI EN 10083-1**

**Material C 45 E  
UNI EN 10083-1**

Z	D <sub>e</sub>	D <sub>p</sub>	PS			
			cod.	d	D	H
8	38,5	33,18	PS 07008	21	8	14
9	41,5	37,13	PS 07009	25	8	14
10	46,2	41,10	PS 07010	28	8	14
11	49,6	45,07	PS 07011	31	8	16
12	53,9	49,07	PS 07012	35	8	16
13	58,4	53,06	PS 07013	39	8	16
14	62,8	57,07	PS 07014	43	8	16
15	66,8	61,09	PS 07015	47	8	16
16	70,9	65,10	PS 07016	50	10	18
17	74,9	69,11	PS 07017	50	10	18
18	78,9	73,14	PS 07018	50	10	18
19	82,9	77,16	PS 07019	50	10	18
20	86,9	81,19	PS 07020	50	10	18
21	91,0	85,22	PS 07021	60	12	20
22	95,0	89,24	PS 07022	60	12	20
23	99,0	93,27	PS 07023	60	12	20
24	103,0	97,29	PS 07024	60	12	20
25	107,1	101,33	PS 07025	60	12	20
26	111,2	105,36	PS 07026	70	16	20
27	115,4	109,40	PS 07027	70	16	20
28	119,4	113,42	PS 07028	70	16	20
29	123,4	117,46	PS 07029	70	16	20
30	127,5	121,50	PS 07030	70	16	20
31	131,5	125,54	PS 07031	70	16	20
32	135,5	129,56	PS 07032	70	16	20
33	139,6	133,60	PS 07033	70	16	20
34	143,6	137,64	PS 07034	70	16	20
35	147,6	141,68	PS 07035	70	16	20
36	151,7	145,72	PS 07036	70	16	25
37	155,7	149,76	PS 07037	70	16	25
38	159,8	153,80	PS 07038	70	16	25
39	163,8	157,83	PS 07039	70	16	25
40	167,8	161,87	PS 07040	70	16	25

Pignoni per catene semplici,  
a rulli secondo: DIN 8187 -  
ISO/R 606

Sprockets for simplex chain  
to: DIN 8187 - ISO/R 606

Kettenräder mit einseitiger  
Nabe für Simplex-Rollenkette  
nach: DIN 8187 - ISO/R 606

Pignons avec moyeu déporté  
pour chaînes simples à rouleaux  
suivant les normes: DIN 8187 -  
ISO/R 606

Piñones para cadena simple  
de rodillos según las normas:  
DIN 8187 - ISO/R 606

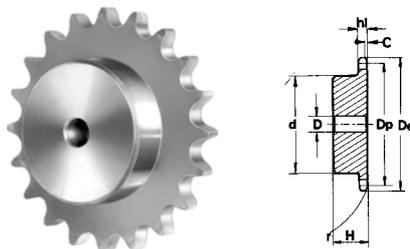

**1/2" x 1/4"**

**085-1 12,7 x 6,4 x 7,75 mm**

CATENA	CHAIN	KETTE	CHAÎNE	CADENA	ISO mm
Passo	Pitch	Teilung	Pas	Paso	<b>12,70</b>
Larghezza interna	Internal width	Innere Breite	Largeur interieure	Ancho interno	<b>6,40</b>
Rullo $\varnothing$	Roller $\varnothing$	Rollen $\varnothing$	$\varnothing$ du rouleau	Rodillo $\varnothing$	<b>7,75</b>

PIGNONE	SPROCKETS	KETTENRÄDER	PIGNONS	PIÑONES	ISO mm
Raggio dente r	Tooth radius r	Radius r	Rayon de denture r	Radio diente r	<b>r 13,0</b>
Larghezza raggio C	Radius width C	Breite C	Largeur de rayon C	Ancho radio C	<b>C 1,3</b>
Largh. dente $h_1$	Tooth width $h_1$	Zahnbreite $h_1$	Larg. de denture $h_1$	Ancho diente $h_1$	<b><math>h_1</math> 5,9</b>
Largh. dente L	Tooth width L	Zahnbreite L	Larg. de denture L	Ancho diente L	<b>L -</b>
Largh. dente $h_2$	Tooth width $h_2$	Zahnbreite $h_2$	Larg. de denture $h_2$	Ancho diente $h_2$	<b><math>h_2</math> -</b>
Largh. dente $h_3$	Tooth width $h_3$	Zahnbreite $h_3$	Larg. de denture $h_3$	Ancho diente $h_3$	<b><math>h_3</math> -</b>
Altezza totale H	Full height H	Gesamt Höhe H	Hauteur totale H	Altura total H	<b>H -</b>

**Materiale C 45 E**  
**UNI EN 10083-1**

**Material C 45 E**  
**UNI EN 10083-1**

**Werkstoff C 45 E**  
**UNI EN 10083-1**

**Matière C 45 E**  
**UNI EN 10083-1**

**Material C 45 E**  
**UNI EN 10083-1**

Z	D <sub>e</sub>	D <sub>p</sub>	PS			
			cod.	d	D	H
8	38,5	33,18	PS 08008	20	10	25
9	41,5	37,13	PS 08009	24	10	25
10	46,2	41,10	PS 08010	26	10	25
11	49,6	45,07	PS 08011	29	10	25
12	53,9	49,07	PS 08012	33	10	28
13	58,4	53,06	PS 08013	37	10	28
14	62,8	57,07	PS 08014	41	10	28
15	66,8	61,09	PS 08015	45	10	28
16	70,9	65,10	PS 08016	50	12	28
17	74,9	69,11	PS 08017	52	12	28
18	78,9	73,14	PS 08018	56	12	28
19	82,9	77,16	PS 08019	60	12	28
20	86,9	81,19	PS 08020	64	12	28
21	91,0	85,22	PS 08021	68	14	28
22	95,0	89,24	PS 08022	70	14	28
23	99,0	93,27	PS 08023	70	14	28
24	103,0	97,29	PS 08024	70	14	28
25	107,1	101,33	PS 08025	70	14	28
26	111,2	105,36	PS 08026	70	16	30
27	115,4	109,40	PS 08027	70	16	30
28	119,4	113,42	PS 08028	70	16	30
29	123,4	117,46	PS 08029	80	16	30
30	127,5	121,50	PS 08030	80	16	30
31	131,5	125,54	PS 08031	90	16	30
32	135,5	129,56	PS 08032	90	16	30
33	139,6	133,60	PS 08033	90	16	30
34	143,6	137,64	PS 08034	90	16	30
35	147,6	141,68	PS 08035	90	16	30
36	151,7	145,72	PS 08036	90	16	35
37	155,7	149,76	PS 08037	90	16	35
38	159,8	153,80	PS 08038	90	16	35
39	163,8	157,83	PS 08039	90	16	35
40	167,8	161,87	PS 08040	90	16	35

Pignoni per catene semplici,  
a rulli secondo: DIN 8187 -  
ISO/R 606

Sprockets for simplex chain  
to: DIN 8187 - ISO/R 606

Kettenräder mit einseitiger  
Nabe für Simplex-Rollenkette  
nach: DIN 8187 - ISO/R 606

Pignons avec moyeu déporté  
pour chaînes simples à rouleaux  
suivant les normes: DIN 8187 -  
ISO/R 606

Piñones para cadena simple  
de rodillos según las normas:  
DIN 8187 - ISO/R 606

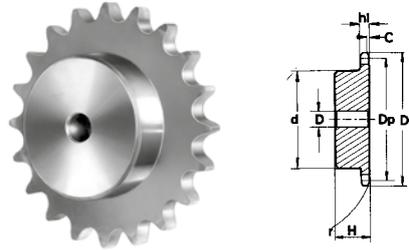

## 1/2" x 1/4"

## 085-1 12,7 x 6,4 x 8,51 mm

CATENA	CHAIN	KETTE	CHAÎNE	CADENA	ISO mm
Passo	Pitch	Teilung	Pas	Paso	<b>12,70</b>
Larghezza interna	Internal width	Innere Breite	Largeur interieure	Ancho interno	<b>6,40</b>
Rullo $\varnothing$	Roller $\varnothing$	Rollen $\varnothing$	$\varnothing$ du rouleau	Rodillo $\varnothing$	<b>8,51</b>

PIGNONE	SPROCKETS	KETTENRÄDER	PIGNONS	PIÑONES	ISO mm
Raggio dente r	Tooth radius r	Radius r	Rayon de denture r	Radio diente r	<b>r 13,0</b>
Larghezza raggio C	Radius width C	Breite C	Largeur de rayon C	Ancho radio C	<b>C 1,3</b>
Largh. dente $h_1$	Tooth width $h_1$	Zahnbreite $h_1$	Larg. de denture $h_1$	Ancho diente $h_1$	<b><math>h_1</math> 5,9</b>
Largh. dente L	Tooth width L	Zahnbreite L	Larg. de denture L	Ancho diente L	<b>L -</b>
Largh. dente $h_2$	Tooth width $h_2$	Zahnbreite $h_2$	Larg. de denture $h_2$	Ancho diente $h_2$	<b><math>h_2</math> -</b>
Largh. dente $h_3$	Tooth width $h_3$	Zahnbreite $h_3$	Larg. de denture $h_3$	Ancho diente $h_3$	<b><math>h_3</math> -</b>
Altezza totale H	Full height H	Gesamt Höhe H	Hauteur totale H	Altura total H	<b>H -</b>

Materiale C 45 E UNI EN 10083-1	Material C 45 E UNI EN 10083-1	Werkstoff C 45 E UNI EN 10083-1	Matière C 45 E UNI EN 10083-1	Material C 45 E UNI EN 10083-1		
Z	D <sub>e</sub>	D <sub>p</sub>	PS			
			cod.	d	D	H
8	37,2	33,18	PS 17008	20	10	25
9	41,0	37,13	PS 17009	24	10	25
10	45,2	41,10	PS 17010	26	10	25
11	48,7	45,07	PS 17011	29	10	25
12	53,0	49,07	PS 17012	33	10	28
13	57,4	53,06	PS 17013	37	10	28
14	61,8	57,07	PS 17014	41	10	28
15	65,5	61,09	PS 17015	45	10	28
16	69,5	65,10	PS 17016	50	12	28
17	73,6	69,11	PS 17017	52	12	28
18	77,8	73,14	PS 17018	56	12	28
19	81,7	77,16	PS 17019	60	12	28
20	85,8	81,19	PS 17020	64	12	28
21	89,7	85,22	PS 17021	68	14	28
22	93,8	89,24	PS 17022	70	14	28
23	98,2	93,27	PS 17023	70	14	28
24	101,8	97,29	PS 17024	70	14	28
25	105,8	101,33	PS 17025	70	14	28
26	110,0	105,36	PS 17026	70	16	30
27	114,0	109,40	PS 17027	70	16	30
28	118,0	113,42	PS 17028	70	16	30
29	122,0	117,46	PS 17029	80	16	30
30	126,1	121,50	PS 17030	80	16	30
31	130,2	125,54	PS 17031	90	16	30
32	134,3	129,56	PS 17032	90	16	30
33	138,4	133,60	PS 17033	90	16	30
34	142,6	137,64	PS 17034	90	16	30
35	146,7	141,68	PS 17035	90	16	30
36	151,0	145,72	PS 17036	90	16	35
37	154,6	149,76	PS 17037	90	16	35
38	158,6	153,80	PS 17038	90	16	35
39	162,7	157,83	PS 17039	90	16	35
40	166,8	161,87	PS 17040	90	16	35

Pignoni per catene semplici, doppie e triple a rulli secondo: DIN 8187 - ISO/R 606

Sprockets for simplex, duplex and triplex chain to: DIN 8187 - ISO/R 606

Kettenräder mit einseitiger Nabe für Simplex- Duplex- Triplex-Rollenkette nach: DIN 8187 - ISO/R 606

Pignons avec moyeu déporté pour chaînes simples, doubles et triples à rouleaux suivant les normes: DIN 8187 - ISO/R 606

Piñones para cadena simple, doble y triple de rodillos segun las normas: DIN 8187 - ISO/R 606

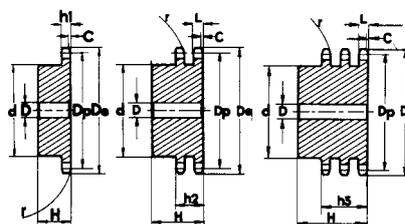

**1/2" x 5/16"**

**08B - 1-2-3 12,7 x 7,75 mm**

CATENA	CHAIN	KETTE	CHAÎNE	CADENA	ISO mm
Passo	Pitch	Teilung	Pas	Paso	<b>12,70</b>
Larghezza interna	Internal width	Innere Breite	Largeur interieure	Ancho interno	<b>7,75</b>
Rullo $\varnothing$	Roller $\varnothing$	Rollen $\varnothing$	$\varnothing$ du rouleau	Rodillo $\varnothing$	<b>8,51</b>

PIGNONE	SPROCKETS	KETTENRÄDER	PIGNONS	PIÑONES	ISO mm
Raggio dente r	Tooth radius r	Radius r	Rayon de denture r	Radio diente r	<b>13,0</b>
Larghezza raggio C	Radius width C	Breite C	Largeur de rayon C	Ancho radio C	<b>C</b>
Largh. dente $h_1$	Tooth width $h_1$	Zahnbreite $h_1$	Larg. de denture $h_1$	Ancho diente $h_1$	<b><math>h_1</math></b>
Largh. dente L	Tooth width L	Zahnbreite L	Larg. de denture L	Ancho diente L	<b>L</b>
Largh. dente $h_2$	Tooth width $h_2$	Zahnbreite $h_2$	Larg. de denture $h_2$	Ancho diente $h_2$	<b><math>h_2</math></b>
Largh. dente $h_3$	Tooth width $h_3$	Zahnbreite $h_3$	Larg. de denture $h_3$	Ancho diente $h_3$	<b><math>h_3</math></b>
Altezza totale H	Full height H	Gesamt Höhe H	Hauteur totale H	Altura total H	<b>H</b>

**Materiale C 45 E**  
**UNI EN 10083-1**

\*Tipi costruiti con mozzo saldato: materiale Fe

**Material C 45 E**  
**UNI EN 10083-1**

\*With welded hub: material Fe

**Werkstoff C 45 E**  
**UNI EN 10083-1**

\*Typen mit eingeschweisster Nabe: Werkstoff Fe

**Matière C 45 E**  
**UNI EN 10083-1**

\*Types avec moyeu soudé: matière Fe

**Material C 45 E**  
**UNI EN 10083-1**

\*Tipos con nucleo soldado: material Fe

Z	D <sub>e</sub>	D <sub>p</sub>	PS				PD				PT			
			cod.	d	D	H	cod.	d	D	H	cod.	d	D	H
8	37,2	33,18	PS 09008	20	10	25	PD 09008	20	10	32	PT 09008	20	10	46
9	41,0	37,13	PS 09009	24	10	25	PD 09009	24	10	32	PT 09009	24	12	46
10	45,2	41,10	PS 09010	26	10	25	PD 09010	28	10	32	PT 09010	28	12	46
11	48,7	45,07	PS 09011	29	10	25	PD 09011	32	12	35	PT 09011	32	14	50
12	53,0	49,07	PS 09012	33	10	28	PD 09012	35	12	35	PT 09012	35	14	50
13	57,4	53,06	PS 09013	37	10	28	PD 09013	38	12	35	PT 09013	38	14	50
14	61,8	57,07	PS 09014	41	10	28	PD 09014	42	12	35	PT 09014	42	14	50
15	65,5	61,09	PS 09015	45	10	28	PD 09015	46	12	35	PT 09015	46	14	50
16	69,5	65,10	PS 09016	50	12	28	PD 09016	50	14	35	PT 09016	50	16	50
17	73,6	69,11	PS 09017	52	12	28	PD 09017	54	14	35	PT 09017	54	16	50
18	77,8	73,14	PS 09018	56	12	28	PD 09018	58	14	35	PT 09018	58	16	50
19	81,7	77,16	PS 09019	60	12	28	PD 09019	62	14	35	PT 09019	62	16	50
20	85,8	81,19	PS 09020	64	12	28	PD 09020	66	14	35	PT 09020	66	16	50
21	89,7	85,22	PS 09021	68	12	28	PD 09021	70	16	40	PT 09021	70	20	55
22	93,8	89,24	PS 09022	70	12	28	PD 09022	70	16	40	PT 09022	70	20	55
23	98,2	93,27	PS 09023	70	14	28	PD 09023	70	16	40	PT 09023	70	20	55
24	101,8	97,29	PS 09024	70	14	28	PD 09024	75	16	40	PT 09024	75	20	55
25	105,8	101,33	PS 09025	70	14	28	PD 09025	80	16	40	PT 09025	80	20	55
26	110,0	105,36	PS 09026	70	16	30	PD 09026	85	20	40	PT 09026	85	20	55
27	114,0	109,40	PS 09027	70	16	30	PD 09027	85	20	40	PT 09027	85	20	55
28	118,0	113,42	PS 09028	70	16	30	PD 09028	90	20	40	PT 09028	90	20	55
29	122,0	117,46	PS 09029	80	16	30	PD 09029	95	20	40	PT 09029	95	20	55
30	126,1	121,50	PS 09030	80	16	30	PD 09030	100	20	40	PT 09030	100	20	55
31	130,2	125,54	PS 09031	90	16	30	PD 09031	100	20	40	PT 09031	110	20	55
32	134,3	129,56	PS 09032	90	16	30	PD 09032	100	20	40	PT 09032	110	20	55
33	138,4	133,60	PS 09033	90	16	30	PD 09033	100	20	40	PT 09033	110	20	55
34	142,6	137,64	PS 09034	90	16	30	PD 09034	100	20	40	PT 09034	110	20	55
35	146,7	141,68	PS 09035	90	16	30	PD 09035	100	20	40	PT 09035	110	20	55
36	151,0	145,72	PS 09036	90	16	35	PD 09036	110	20	40	PT 09036	120	25	55
37	154,6	149,76	PS 09037	90	16	35	PD 09037	110	20	40	PT 09037	120	25	55
38	158,6	153,80	PS 09038	90	16	35	PD 09038	110	20	40	PT 09038	120	25	55
39	162,7	157,83	PS 09039	90	16	35	PD 09039	110	20	40	PT 09039	120	25	55
40	166,8	161,87	PS 09040	90	16	35	PD 09040	110	20	40	PT 09040	120	25	55
42	175,4	169,95	PS 09042	88*	20	42	PD 09042	108*	20	55				
45	188,0	182,07	PS 09045	88*	20	42	PD 09045	108*	20	55	PT 09045	120*	25	68
46	192,1	186,10	PS 09046	88*	20	42	PD 09046	108*	20	55				
48	200,3	194,18	PS 09048	88*	20	42	PD 09048	108*	20	55				
50	208,3	202,26	PS 09050	88*	20	42	PD 09050	108*	20	55	PT 09050	120*	25	68
55	228,1	222,46	PS 09055	88*	20	42								
57	236,4	230,54	PS 09057	88*	20	42	PD 09057	108*	25	55	PT 09057	120*	25	68
60	248,6	242,66	PS 09060	88*	20	42	PD 09060	108*	25	55	PT 09060	120*	25	68
76	313,3	307,33	PS 09076	88*	25	42	PD 09076	108*	25	55	PT 09076	120*	25	68
95	390,1	384,11	PS 09095	108*	25	42	PD 09095	120*	25	55	PT 09095	136*	25	68

Pignoni per catene semplici, doppie e triple a rulli secondo: DIN 8187 - ISO/R 606

Sprockets for simplex, duplex and triplex chain to: DIN 8187 - ISO/R 606

Kettenräder mit einseitiger Nabe für Simplex- Duplex- Triplex-Rollenkette nach: DIN 8187 - ISO/R 606

Pignons avec moyeu déporté pour chaînes simples, doubles et triples à rouleaux suivant les normes: DIN 8187 - ISO/R 606

Piñones para cadena simple, doble y triple de rodillos segun las normas: DIN 8187 - ISO/R 606

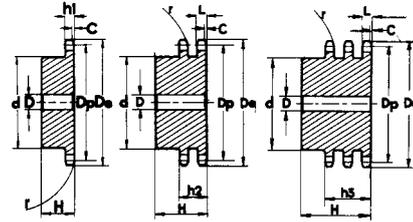

## 5/8" x 3/8"

## 10B - 1-2-3 15,875 x 9,65 mm

CATENA	CHAIN	KETTE	CHAÎNE	CADENA	ISO mm
Passo	Pitch	Teilung	Pas	Paso	<b>15,875</b>
Larghezza interna	Internal width	Innere Breite	Largeur interieure	Ancho interno	<b>9,650</b>
Rullo $\varnothing$	Roller $\varnothing$	Rollen $\varnothing$	$\varnothing$ du rouleau	Rodillo $\varnothing$	<b>10,160</b>

PIGNONE	SPROCKETS	KETTENRÄDER	PIGNONS	PIÑONES	ISO mm
Raggio dente r	Tooth radius r	Radius r	Rayon de denture r	Radio diente r	<b>16,0</b>
Larghezza raggio C	Radius width C	Breite C	Largeur de rayon C	Ancho radio C	<b>1,6</b>
Largh. dente $h_1$	Tooth width $h_1$	Zahnbreite $h_1$	Larg. de denture $h_1$	Ancho diente $h_1$	<b>9,1</b>
Largh. dente L	Tooth width L	Zahnbreite L	Larg. de denture L	Ancho diente L	<b>9,0</b>
Largh. dente $h_2$	Tooth width $h_2$	Zahnbreite $h_2$	Larg. de denture $h_2$	Ancho diente $h_2$	<b>25,5</b>
Largh. dente $h_3$	Tooth width $h_3$	Zahnbreite $h_3$	Larg. de denture $h_3$	Ancho diente $h_3$	<b>42,1</b>
Altezza totale H	Full height H	Gesamt Höhe H	Hauteur totale H	Altura total H	-

**Materiale C 45 E**  
**UNI EN 10083-1**

\*Tipi costruiti con mozzo saldato: materiale Fe

**Material C 45 E**  
**UNI EN 10083-1**

\*With welded hub: material Fe

**Werkstoff C 45 E**  
**UNI EN 10083-1**

\*Typen mit eingeschweisster Nabe: Werkstoff Fe

**Matière C 45 E**  
**UNI EN 10083-1**

\*Tipes avec moyeu soudé: matière Fe

**Material C 45 E**  
**UNI EN 10083-1**

\*Tipos con nucleo soldado: material Fe

Z	D <sub>e</sub>	D <sub>p</sub>	PS				PD				PT			
			cod.	d	D	H	cod.	d	D	H	cod.	d	D	H
8	47,0	41,48	PS 10008	25	10	25	PD 10008	25	12	40	PT 10008	25	12	55
9	52,6	46,42	PS 10009	30	10	25	PD 10009	30	12	40	PT 10009	30	12	55
10	57,5	51,37	PS 10010	35	10	25	PD 10010	35	12	40	PT 10010	35	16	55
11	63,0	56,34	PS 10011	37	12	30	PD 10011	39	14	40	PT 10011	39	16	55
12	68,0	61,34	PS 10012	42	12	30	PD 10012	44	14	40	PT 10012	44	16	55
13	73,0	66,32	PS 10013	47	12	30	PD 10013	49	14	40	PT 10013	49	16	55
14	78,0	71,34	PS 10014	52	12	30	PD 10014	54	14	40	PT 10014	54	16	55
15	83,0	76,36	PS 10015	57	12	30	PD 10015	59	14	40	PT 10015	59	16	55
16	88,0	81,37	PS 10016	60	12	30	PD 10016	64	16	45	PT 10016	64	16	60
17	93,0	86,39	PS 10017	60	12	30	PD 10017	69	16	45	PT 10017	69	16	60
18	98,3	91,42	PS 10018	70	14	30	PD 10018	74	16	45	PT 10018	74	16	60
19	103,3	96,45	PS 10019	70	14	30	PD 10019	79	16	45	PT 10019	79	16	60
20	108,4	101,49	PS 10020	75	14	30	PD 10020	84	16	45	PT 10020	84	16	60
21	113,4	106,52	PS 10021	75	16	30	PD 10021	85	16	45	PT 10021	85	20	60
22	118,0	111,55	PS 10022	80	16	30	PD 10022	90	16	45	PT 10022	90	20	60
23	123,4	116,58	PS 10023	80	16	30	PD 10023	95	16	45	PT 10023	95	20	60
24	128,3	121,62	PS 10024	80	16	30	PD 10024	100	16	45	PT 10024	100	20	60
25	134,0	126,66	PS 10025	80	16	30	PD 10025	105	16	45	PT 10025	105	20	60
26	139,0	131,70	PS 10026	85	20	35	PD 10026	110	20	45	PT 10026	110	20	60
27	144,0	136,75	PS 10027	85	20	35	PD 10027	110	20	45	PT 10027	110	20	60
28	148,7	141,78	PS 10028	90	20	35	PD 10028	115	20	45	PT 10028	115	20	60
29	153,8	146,83	PS 10029	90	20	35	PD 10029	115	20	45	PT 10029	115	20	60
30	158,8	151,87	PS 10030	90	20	35	PD 10030	120	20	45	PT 10030	120	20	60
31	163,9	156,92	PS 10031	95	20	35	PD 10031	120	20	45	PT 10031	120	20	60
32	168,9	161,95	PS 10032	95	20	35	PD 10032	120	20	45	PT 10032	120	20	60
33	174,5	167,00	PS 10033	95	20	35	PD 10033	120	20	45	PT 10033	120	20	60
34	179,0	172,05	PS 10034	95	20	35	PD 10034	120	20	45	PT 10034	120	20	60
35	184,1	177,10	PS 10035	95	20	35	PD 10035	120	20	45	PT 10035	120	20	60
36	189,1	182,15	PS 10036	100	20	35	PD 10036	120	20	45	PT 10036	120	25	60
37	194,2	187,20	PS 10037	100	20	35	PD 10037	120	20	45	PT 10037	120	25	60
38	199,2	192,24	PS 10038	100	20	35	PD 10038	120	20	45	PT 10038	120	25	60
39	204,2	197,29	PS 10039	100	20	35	PD 10039	120	20	45	PT 10039	120	25	60
40	209,3	202,34	PS 10040	100	20	35	PD 10040	120	20	45	PT 10040	120	25	60
42	219,9	212,44	PS 10042	108*	20	43	PD 10042	120*	25	59				
45	235,0	227,58	PS 10045	108*	20	43	PD 10045	120*	25	59	PT 10045	136*	25	74
46	240,1	232,63	PS 10046	108*	20	43	PD 10046	120*	25	59				
48	250,2	242,73	PS 10048	108*	20	43	PD 10048	120*	25	59				
50	260,3	252,82	PS 10050	108*	20	43	PD 10050	120*	25	59	PT 10050	136*	25	74
55	285,5	278,08	PS 10055	108*	20	43	PD 10055	120*	25	59				
57	296,0	288,18	PS 10057	108*	25	43	PD 10057	120*	25	59	PT 10057	136*	25	74
60	310,8	303,32	PS 10060	108*	25	43	PD 10060	120*	25	59	PT 10060	136*	25	74
76	392,1	384,16	PS 10076	108*	25	43	PD 10076	120*	25	59	PT 10076	145*	30	75
95	488,5	480,14	PS 10095	118*	30	59	PD 10095	145*	30	58	PT 10095	145*	30	75



Pignoni per catene semplici, doppie e triple a rulli secondo: DIN 8187 - ISO/R 606

Sprockets for simplex, duplex and triplex chain to: DIN 8187 - ISO/R 606

Kettenräder mit einseitiger Nabe für Simplex- Duplex- Triplex-Rollenkette nach: DIN 8187 - ISO/R 606

Pignons avec moyeu déporté pour chaînes simples, doubles et triples à rouleaux suivant les normes: DIN 8187 - ISO/R 606

Piñones para cadena simple, doble y triple de rodillos segun las normas: DIN 8187 - ISO/R 606

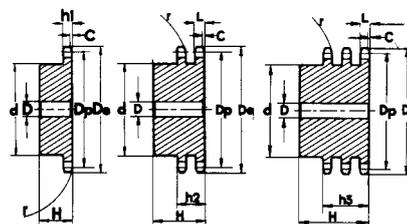

**3/4" x 7/16"**

**12B - 1-2-3 19,05 x 11,68 mm**

CATENA	CHAIN	KETTE	CHAÎNE	CADENA	ISO mm
Passo	Pitch	Teilung	Pas	Paso	<b>19,05</b>
Larghezza interna	Internal width	Innere Breite	Largeur interieure	Ancho interno	<b>11,68</b>
Rullo ø	Roller ø	Rollen ø	ø du rouleau	Rodillo ø	<b>12,07</b>

PIGNONE	SPROCKETS	KETTENRÄDER	PIGNONS	PIÑONES	ISO mm
Raggio dente r	Tooth radius r	Radius r	Rayon de denture r	Radio diente r	<b>r 19,0</b>
Larghezza raggio C	Radius width C	Breite C	Largeur de rayon C	Ancho radio C	<b>C 2,0</b>
Largh. dente h <sub>1</sub>	Tooth width h <sub>1</sub>	Zahnbreite h <sub>1</sub>	Larg. de denture h <sub>1</sub>	Ancho diente h <sub>1</sub>	<b>h<sub>1</sub> 11,1</b>
Largh. dente L	Tooth width L	Zahnbreite L	Larg. de denture L	Ancho diente L	<b>L 10,8</b>
Largh. dente h <sub>2</sub>	Tooth width h <sub>2</sub>	Zahnbreite h <sub>2</sub>	Larg. de denture h <sub>2</sub>	Ancho diente h <sub>2</sub>	<b>h<sub>2</sub> 30,3</b>
Largh. dente h <sub>3</sub>	Tooth width h <sub>3</sub>	Zahnbreite h <sub>3</sub>	Larg. de denture h <sub>3</sub>	Ancho diente h <sub>3</sub>	<b>h<sub>3</sub> 49,8</b>
Altezza totale H	Full height H	Gesamt Höhe H	Hauteur totale H	Altura total H	<b>H -</b>

**Materiale C 45 E**  
**UNI EN 10083-1**

\*Tipi costruiti con mozzo saldato: materiale Fe

**Material C 45 E**  
**UNI EN 10083-1**

\*With welded hub: material Fe

**Werkstoff C 45 E**  
**UNI EN 10083-1**

\*Typen mit eingeschweisster Nabe: Werkstoff Fe

**Matière C 45 E**  
**UNI EN 10083-1**

\*Tipos avec moyeu soudé: matière Fe

**Material C 45 E**  
**UNI EN 10083-1**

\*Tipos con nucleo soldado: material Fe

Z	D <sub>e</sub>	D <sub>p</sub>	PS				PD				PT			
			cod.	d	D	H	cod.	d	D	H	cod.	d	D	H
8	57,6	49,78	PS 11008	31	12	30	PD 11008	31	12	45	PT 11008	31	16	65
9	62,0	55,70	PS 11009	37	12	30	PD 11009	37	12	45	PT 11009	37	16	65
10	69,0	61,64	PS 11010	42	12	30	PD 11010	42	12	45	PT 11010	42	16	65
11	75,0	67,61	PS 11011	46	14	35	PD 11011	47	16	50	PT 11011	47	20	70
12	81,5	73,60	PS 11012	52	14	35	PD 11012	53	16	50	PT 11012	53	20	70
13	87,5	79,59	PS 11013	58	14	35	PD 11013	59	16	50	PT 11013	59	20	70
14	93,6	85,61	PS 11014	64	14	35	PD 11014	65	16	50	PT 11014	65	20	70
15	99,8	91,63	PS 11015	70	14	35	PD 11015	71	16	50	PT 11015	71	20	70
16	105,5	97,65	PS 11016	75	16	35	PD 11016	77	20	50	PT 11016	77	20	70
17	111,5	103,67	PS 11017	80	16	35	PD 11017	83	20	50	PT 11017	83	20	70
18	118,0	109,71	PS 11018	80	16	35	PD 11018	89	20	50	PT 11018	89	20	70
19	124,2	115,75	PS 11019	80	16	35	PD 11019	95	20	50	PT 11019	95	20	70
20	129,7	121,78	PS 11020	80	16	35	PD 11020	100	20	50	PT 11020	100	20	70
21	136,0	127,82	PS 11021	90	20	40	PD 11021	100	20	50	PT 11021	100	20	70
22	141,8	133,86	PS 11022	90	20	40	PD 11022	100	20	50	PT 11022	100	20	70
23	149,0	139,90	PS 11023	90	20	40	PD 11023	110	20	50	PT 11023	110	20	70
24	153,9	145,94	PS 11024	90	20	40	PD 11024	110	20	50	PT 11024	110	20	70
25	160,0	152,00	PS 11025	90	20	40	PD 11025	120	20	50	PT 11025	120	20	70
26	165,9	158,04	PS 11026	95	20	40	PD 11026	120	20	50	PT 11026	120	20	70
27	172,3	164,09	PS 11027	95	20	40	PD 11027	120	20	50	PT 11027	120	20	70
28	178,0	170,13	PS 11028	95	20	40	PD 11028	120	20	50	PT 11028	120	20	70
29	184,1	176,19	PS 11029	95	20	40	PD 11029	120	20	50	PT 11029	120	20	70
30	190,5	182,25	PS 11030	95	20	40	PD 11030	120	20	50	PT 11030	120	20	70
31	196,3	188,31	PS 11031	100	20	40	PD 11031	130	20	50	PT 11031	130	25	70
32	203,3	194,35	PS 11032	100	20	40	PD 11032	130	20	50	PT 11032	130	25	70
33	209,3	200,40	PS 11033	100	20	40	PD 11033	130	20	50	PT 11033	130	25	70
34	214,6	206,46	PS 11034	100	20	40	PD 11034	130	20	50	PT 11034	130	25	70
35	221,0	212,52	PS 11035	100	20	40	PD 11035	130	20	50	PT 11035	130	25	70
36	226,8	218,58	PS 11036	100	20	40	PD 11036	130	25	50	PT 11036	130	25	70
37	232,9	224,64	PS 11037	100	20	40	PD 11037	130	25	50	PT 11037	130	25	70
38	239,0	230,69	PS 11038	100	20	40	PD 11038	130	25	50	PT 11038	130	25	70
39	245,1	236,75	PS 11039	100	20	40	PD 11039	130	25	50	PT 11039	130	25	70
40	251,3	242,81	PS 11040	100	20	40	PD 11040	130	25	50	PT 11040	130	25	70
42	264,5	254,93	PS 11042	118*	25	61	PD 11042	136*	25	62				
45	282,5	273,10	PS 11045	118*	25	61	PD 11045	136*	25	62	PT 11045	140*	25	72
46	287,9	279,16	PS 11046	118*	25	61	PD 11046	136*	25	62				
48	300,1	291,27	PS 11048	118*	25	61	PD 11048	136*	25	62				
50	312,3	303,39	PS 11050	118*	25	61	PD 11050	136*	25	62	PT 11050	140*	25	72
55	342,7	333,70	PS 11055	118*	25	61	PD 11055	136*	25	62				
57	355,4	345,81	PS 11057	118*	25	61	PD 11057	136*	25	62	PT 11057	140*	30	75
60	373,0	363,99	PS 11060	118*	25	61	PD 11060	136*	25	62	PT 11060	140*	30	75
76	469,9	460,99	PS 11076	118*	30	61	PD 11076	145*	30	63	PT 11076	150*	30	75
95	585,1	576,17	PS 11095	133*	30	62	PD 11095	145*	30	63	PT 11095	150*	30	75

Pignoni per catene semplici, doppie e triple a rulli secondo: DIN 8187 - ISO/R 606

Sprockets for simplex, duplex and triplex chain to: DIN 8187 - ISO/R 606

Kettenräder mit einseitiger Nabe für Simplex- Duplex- Triplex-Rollenkette nach: DIN 8187 - ISO/R 606

Pignons avec moyeu déporté pour chaînes simples, doubles et triples à rouleaux suivant les normes: DIN 8187 - ISO/R 606

Piñones para cadena simple, doble y triple de rodillos segun las normas: DIN 8187 - ISO/R 606

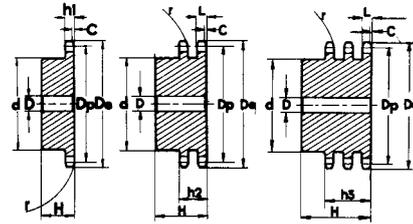

## 1" x 17,02 mm

## 16B - 1-2-3 25,4 x 17,02 mm

CATENA	CHAIN	KETTE	CHAÎNE	CADENA	ISO mm
Passo	Pitch	Teilung	Pas	Paso	25,40
Larghezza interna	Internal width	Innere Breite	Largeur interieure	Ancho interno	17,02
Rullo ø	Roller ø	Rollen ø	ø du rouleau	Rodillo ø	15,88

PIGNONE	SPROCKETS	KETTENRÄDER	PIGNONS	PIÑONES	ISO mm
Raggio dente r	Tooth radius r	Radius r	Rayon de denture r	Radio diente r	26,0
Larghezza raggio C	Radius width C	Breite C	Largeur de rayon C	Ancho radio C	2,5
Largh. dente h <sub>1</sub>	Tooth width h <sub>1</sub>	Zahnbreite h <sub>1</sub>	Larg. de denture h <sub>1</sub>	Ancho diente h <sub>1</sub>	h <sub>1</sub> 16,2
Largh. dente L	Tooth width L	Zahnbreite L	Larg. de denture L	Ancho diente L	L 15,8
Largh. dente h <sub>2</sub>	Tooth width h <sub>2</sub>	Zahnbreite h <sub>2</sub>	Larg. de denture h <sub>2</sub>	Ancho diente h <sub>2</sub>	h <sub>2</sub> 47,7
Largh. dente h <sub>3</sub>	Tooth width h <sub>3</sub>	Zahnbreite h <sub>3</sub>	Larg. de denture h <sub>3</sub>	Ancho diente h <sub>3</sub>	h <sub>3</sub> 79,6
Altezza totale H	Full height H	Gesamt Höhe H	Hauteur totale H	Altura total H	-

**Materiale C 45 E  
UNI EN 10083-1**

**Material C 45 E  
UNI EN 10083-1**

**Werkstoff C 45 E  
UNI EN 10083-1**

**Matière C 45 E  
UNI EN 10083-1**

**Material C 45 E  
UNI EN 10083-1**

\*Tipi costruiti con mozzo saldato: materiale Fe

\*With welded hub: material Fe

\*Typen mit eingeschweisster Nabe: Werkstoff Fe

\*Tipos avec moyeu soudé: matière Fe

\*Tipos con nucleo soldado: material Fe

Z	D <sub>e</sub>	D <sub>p</sub>	PS				PD				PT			
			cod.	d	D	H	cod.	d	D	H	cod.	d	D	H
8	77,0	66,37	PS 12008	42	16	35	PD 12008	42	16	65	PT 12008	42	20	95
9	85,0	74,27	PS 12009	50	16	35	PD 12009	50	16	65	PT 12009	50	20	95
10	93,0	82,19	PS 12010	55	16	35	PD 12010	56	16	65	PT 12010	56	20	95
11	99,5	90,14	PS 12011	61	16	40	PD 12011	64	20	70	PT 12011	64	25	100
12	109,0	98,14	PS 12012	69	16	40	PD 12012	72	20	70	PT 12012	72	25	100
13	117,0	106,12	PS 12013	78	16	40	PD 12013	80	20	70	PT 12013	80	25	100
14	125,0	114,15	PS 12014	84	16	40	PD 12014	88	20	70	PT 12014	88	25	100
15	133,0	122,17	PS 12015	92	16	40	PD 12015	96	20	70	PT 12015	96	25	100
16	141,0	130,20	PS 12016	100	20	45	PD 12016	104	20	70	PT 12016	104	30	100
17	149,0	138,22	PS 12017	100	20	45	PD 12017	112	20	70	PT 12017	112	30	100
18	157,0	146,28	PS 12018	100	20	45	PD 12018	120	20	70	PT 12018	120	30	100
19	165,2	154,33	PS 12019	100	20	45	PD 12019	128	20	70	PT 12019	128	30	100
20	173,2	162,38	PS 12020	100	20	45	PD 12020	130	20	70	PT 12020	130	30	100
21	181,2	170,43	PS 12021	110	20	50	PD 12021	130	25	70	PT 12021	130*	30	100
22	189,3	178,48	PS 12022	110	20	50	PD 12022	130*	25	70	PT 12022	130*	30	100
23	197,5	186,53	PS 12023	110	20	50	PD 12023	130*	25	70	PT 12023	130*	30	100
24	205,5	194,59	PS 12024	110	20	50	PD 12024	130*	25	70	PT 12024	130*	30	100
25	213,5	202,66	PS 12025	110	20	50	PD 12025	130*	25	70	PT 12025	130*	30	100
26	221,6	210,72	PS 12026	120	20	50	PD 12026	130*	25	70	PT 12026	130*	30	100
27	229,6	218,79	PS 12027	120	20	50	PD 12027	130*	25	70	PT 12027	130*	30	100
28	237,7	226,85	PS 12028	120	20	50	PD 12028	130*	25	70	PT 12028	130*	30	100
29	245,8	234,92	PS 12029	120	20	50	PD 12029	130*	25	70	PT 12029	130*	30	100
30	254,0	243,00	PS 12030	120	20	50	PD 12030	130*	25	70	PT 12030	130*	30	100
31	262,0	251,08	PS 12031	120*	25	50	PD 12031	140*	25	70	PT 12031	130*	30	100
32	270,0	259,13	PS 12032	120*	25	50	PD 12032	140*	25	70	PT 12032	140*	30	100
33	278,5	267,21	PS 12033	120*	25	50	PD 12033	140*	25	70	PT 12033	140*	30	100
34	287,0	275,28	PS 12034	120*	25	50	PD 12034	140*	25	70	PT 12034	140*	30	100
35	296,2	283,36	PS 12035	120*	25	50	PD 12035	140*	25	70	PT 12035	140*	30	100
36	304,6	291,44	PS 12036	120*	25	50	PD 12036	140*	25	70	PT 12036	140*	30	100
37	312,6	299,51	PS 12037	120*	25	50	PD 12037	140*	25	70	PT 12037	140*	30	100
38	320,7	307,59	PS 12038	120*	25	50	PD 12038	140*	25	70	PT 12038	140*	30	100
39	328,8	315,67	PS 12039	120*	25	50	PD 12039	140*	25	70	PT 12039	140*	30	100
40	336,9	323,73	PS 12040	120*	25	50	PD 12040	140*	25	70	PT 12040	140*	30	100
42	353,0	339,90	PS 12042	133*	25	68	PD 12042	140*	25	70				
45	377,1	364,12	PS 12045	133*	25	68	PD 12045	140*	25	70	PT12045	160*	30	110
46	385,2	372,21	PS 12046	133*	25	68	PD 12046	140*	25	70				
48	401,3	388,36	PS 12048	133*	25	68	PD 12048	140*	25	70				
50	417,4	404,52	PS 12050	133*	25	68	PD 12050	140*	25	70	PT12050	160*	30	110
57	474,0	461,07	PS 12057	133*	30	68	PD 12057	160*	40	82	PT12057	180*	40	112
60	498,3	485,32	PS 12060	133*	30	68	PD 12060	160*	40	82				
76	627,0	614,65	PS 12076	145*	30	68	PD 12076	160*	40	82	PT12076	180*	40	112
95	781,1	768,22	PS 12095	160*	30	78	PD 12095	180*	40	109	PT12095	180*	40	112

Pignoni per catene semplici, doppie e triple a rulli secondo: DIN 8187 - ISO/R 606

Sprockets for simplex, duplex and triplex chain to: DIN 8187 - ISO/R 606

Kettenräder mit einseitiger Nabe für Simplex- Duplex- Triplex-Rollenkette nach: DIN 8187 - ISO/R 606

Pignons avec moyeu déporté pour chaînes simples, doubles et triples à rouleaux suivant les normes: DIN 8187 - ISO/R 606

Piñones para cadena simple, doble y triple de rodillos segun las normas: DIN 8187 - ISO/R 606

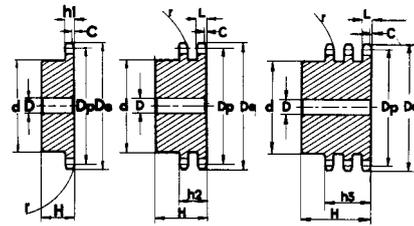

**1"1/4 x 3/4"**

**20B - 1-2-3 31,75 x 19,56 mm**

CATENA	CHAIN	KETTE	CHAÎNE	CADENA	ISO mm
Passo	Pitch	Teilung	Pas	Paso	<b>31,75</b>
Larghezza interna	Internal width	Innere Breite	Largeur interieure	Ancho interno	<b>19,56</b>
Rullo ø	Roller ø	Rollen ø	ø du rouleau	Rodillo ø	<b>19,05</b>

PIGNONE	SPROCKETS	KETTENRÄDER	PIGNONS	PIÑONES	ISO mm
Raggio dente r	Tooth radius r	Radius r	Rayon de denture r	Radio diente r	<b>32,0</b>
Larghezza raggio C	Radius width C	Breite C	Largeur de rayon C	Ancho radio C	<b>3,5</b>
Largh. dente h <sub>1</sub>	Tooth width h <sub>1</sub>	Zahnbreite h <sub>1</sub>	Larg. de denture h <sub>1</sub>	Ancho diente h <sub>1</sub>	<b>18,5</b>
Largh. dente L	Tooth width L	Zahnbreite L	Larg. de denture L	Ancho diente L	<b>18,2</b>
Largh. dente h <sub>2</sub>	Tooth width h <sub>2</sub>	Zahnbreite h <sub>2</sub>	Larg. de denture h <sub>2</sub>	Ancho diente h <sub>2</sub>	<b>54,6</b>
Largh. dente h <sub>3</sub>	Tooth width h <sub>3</sub>	Zahnbreite h <sub>3</sub>	Larg. de denture h <sub>3</sub>	Ancho diente h <sub>3</sub>	<b>91,0</b>
Altezza totale H	Full height H	Gesamt Höhe H	Hauteur totale H	Altura total H	-

Materiale C 45 E UNI EN 10083-1	Material C 45 E UNI EN 10083-1	Werkstoff C 45 E UNI EN 10083-1	Matière C 45 E UNI EN 10083-1	Material C 45 E UNI EN 10083-1
*Tipi costruiti con mozzo saldato: materiale Fe	*With welded hub: material Fe	*Typen mit eingeschweisster Nabe: Werkstoff Fe	*Tipos avec moyeu soudé: matière Fe	*Tipos con nucleo soldado: material Fe

Z	D <sub>e</sub>	D <sub>p</sub>	PS				PD				PT			
			cod.	d	D	H	cod.	d	D	H	cod.	d	D	H
8	98,1	82,96	PS 13008	53	20	40	PD 13008	53	20	75	PT 13008	53	20	110
9	108,0	92,84	PS 13009	63	20	40	PD 13009	63	20	75	PT 13009	63	20	110
10	117,9	102,74	PS 13010	70	20	40	PD 13010	70	20	75	PT 13010	70	20	110
11	127,8	112,68	PS 13011	77	20	45	PD 13011	80	20	80	PT 13011	80	20	115
12	137,8	122,68	PS 13012	88	20	45	PD 13012	90	20	80	PT 13012	90	20	115
13	147,8	132,65	PS 13013	98	20	45	PD 13013	100	20	80	PT 13013	100	20	115
14	157,8	142,68	PS 13014	108	20	45	PD 13014	110	20	80	PT 13014	110	20	115
15	167,9	152,72	PS 13015	118	20	45	PD 13015	120	20	80	PT 13015	120	20	115
16	177,9	162,75	PS 13016	120	25	50	PD 13016	120	25	80	PT 13016	120	25	115
17	187,9	172,78	PS 13017	120	25	50	PD 13017	120	25	80	PT 13017	120	25	115
18	198,0	182,85	PS 13018	120	25	50	PD 13018	120*	25	80	PT 13018	120*	25	115
19	208,1	192,91	PS 13019	120	25	50	PD 13019	120*	25	80	PT 13019	120*	25	115
20	218,1	202,98	PS 13020	120	25	50	PD 13020	120*	25	80	PT 13020	120*	25	115
21	228,2	213,04	PS 13021	140	25	55	PD 13021	140*	25	80	PT 13021	140*	25	115
22	238,3	223,11	PS 13022	140	25	55	PD 13022	140*	25	80	PT 13022	140*	25	115
23	248,3	233,17	PS 13023	140	25	55	PD 13023	140*	25	80	PT 13023	140*	25	115
24	258,4	243,23	PS 13024	140	25	55	PD 13024	140*	25	80	PT 13024	140*	25	115
25	268,5	253,33	PS 13025	140	25	55	PD 13025	140*	25	80	PT 13025	140*	25	115
26	278,6	263,40	PS 13026	150*	25	55	PD 13026	150*	25	80	PT 13026	150*	25	115
27	288,6	273,48	PS 13027	150*	25	55	PD 13027	150*	25	80	PT 13027	150*	25	115
28	298,7	283,56	PS 13028	150*	25	55	PD 13028	150*	25	80	PT 13028	150*	25	115
29	308,8	293,65	PS 13029	150*	25	55	PD 13029	150*	25	80	PT 13029	150*	25	115
30	318,9	303,75	PS 13030	150*	25	55	PD 13030	150*	25	80	PT 13030	150*	25	115
31	329,0	313,85	PS 13031	150*	25	55	PD 13031	150*	25	80	PT 13031	150*	30	115
32	339,1	323,91	PS 13032	150*	25	55	PD 13032	150*	25	80	PT 13032	150*	30	115
33	349,2	334,01	PS 13033	150*	25	55	PD 13033	150*	25	80	PT 13033	150*	30	115
34	359,3	334,10	PS 13034	150*	25	55	PD 13034	150*	25	80	PT 13034	150*	30	115
35	369,4	354,20	PS 13035	150*	25	55	PD 13035	150*	25	80	PT 13035	150*	30	115
36	379,5	364,30	PS 13036	150*	25	55	PD 13036	150*	30	80	PT 13036	150*	30	115
37	389,5	374,39	PS 13037	150*	25	55	PD 13037	150*	30	80	PT 13037	150*	30	115
38	399,6	384,49	PS 13038	150*	25	55	PD 13038	150*	30	80	PT 13038	150*	30	115
39	409,7	394,59	PS 13039	150*	25	55	PD 13039	150*	30	80	PT 13039	150*	30	115
40	419,8	404,66	PS 13040	150*	25	55	PD 13040	150*	30	80	PT 13040	150*	30	115
42	440,0	424,88	PS 13042	160*	30	80								
45	470,3	455,17	PS 13045	160*	30	80	PD 13045	160*	30	101	PT 13045	160*	40	121
46	480,4	465,26	PS 13046	160*	25	80	PD 13046	160*	30	101				
48	500,6	485,46	PS 13048	160*	25	80								
50	520,8	505,65	PS 13050	160*	25	80	PD 13050	160*	30	101	PT 13050	160*	40	121
57	591,5	578,36	PS 13057	160*	30	80	PD 13057	180*	40	116	PT 13057	200*	40	123
60	621,8	606,65	PS 13060	160*	30	80								
76	783,5	768,32	PS 13076	160*	30	80	PD 13076	180*	40	116	PT 13076	200*	40	123
95	975,2	960,28	PS 13095	168*	30	93	PD 13095	200*	40	116				

Pignoni per catene semplici, doppie e triple a rulli secondo: DIN 8187 - ISO/R 606

Sprockets for simplex, duplex and triplex chain to: DIN 8187 - ISO/R 606

Kettenräder mit einseitiger Nabe für Simplex- Duplex- Triplex-Rollenkette nach: DIN 8187 - ISO/R 606

Pignons avec moyeu déporté pour chaînes simples, doubles et triples à rouleaux suivant les normes: DIN 8187 - ISO/R 606

Piñones para cadena simple, doble y triple de rodillos segun las normas: DIN 8187 - ISO/R 606

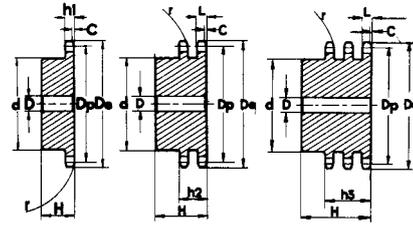

**1"1/2 x 1"**

**24B - 1-2-3 38,1 x 25,4 mm**

CATENA	CHAIN	KETTE	CHAÎNE	CADENA	ISO mm
Passo	Pitch	Teilung	Pas	Paso	<b>38,1</b>
Larghezza interna	Internal width	Innere Breite	Largeur interieure	Ancho interno	<b>25,4</b>
Rullo ø	Roller ø	Rollen ø	ø du rouleau	Rodillo ø	<b>25,4</b>

PIGNONE	SPROCKETS	KETTENRÄDER	PIGNONS	PIÑONES	ISO mm
Raggio dente r	Tooth radius r	Radius r	Rayon de denture r	Radio diente r	<b>38,0</b>
Larghezza raggio C	Radius width C	Breite C	Largeur de rayon C	Ancho radio C	<b>4,0</b>
Largh. dente h <sub>1</sub>	Tooth width h <sub>1</sub>	Zahnbreite h <sub>1</sub>	Larg. de denture h <sub>1</sub>	Ancho diente h <sub>1</sub>	<b>h<sub>1</sub> 24,1</b>
Largh. dente L	Tooth width L	Zahnbreite L	Larg. de denture L	Ancho diente L	<b>L 23,6</b>
Largh. dente h <sub>2</sub>	Tooth width h <sub>2</sub>	Zahnbreite h <sub>2</sub>	Larg. de denture h <sub>2</sub>	Ancho diente h <sub>2</sub>	<b>h<sub>2</sub> 72,0</b>
Largh. dente h <sub>3</sub>	Tooth width h <sub>3</sub>	Zahnbreite h <sub>3</sub>	Larg. de denture h <sub>3</sub>	Ancho diente h <sub>3</sub>	<b>h<sub>3</sub> 120,3</b>
Altezza totale H	Full height H	Gesamt Höhe H	Hauteur totale H	Altura total H	<b>H -</b>

Materiale C 45 E UNI EN 10083-1	Material C 45 E UNI EN 10083-1	Werkstoff C 45 E UNI EN 10083-1	Matière C 45 E UNI EN 10083-1	Material C 45 E UNI EN 10083-1
*Tipi costruiti con mozzo saldato: materiale Fe	*With welded hub: material Fe	*Typen mit eingeschweisster Nabe: Werkstoff Fe	*Tipos avec moyeu soudé: matière Fe	*Tipos con nucleo soldado: material Fe

Z	D <sub>e</sub>	D <sub>p</sub>	PS				PD				PT			
			cod.	d	D	H	cod.	d	D	H	cod.	d	D	H
8	115,0	99,55	PS 14008	58	20	45	PD 14008	58	25	95	PT 14008	58	25	140
9	126,4	111,40	PS 14009	70	20	45	PD 14009	70	25	95	PT 14009	70	25	140
10	138,0	123,29	PS 14010	80	20	45	PD 14010	80	25	95	PT 14010	80	25	140
11	150,0	135,21	PS 14011	90	25	50	PD 14011	90	25	100	PT 14011	90	25	150
12	162,0	147,22	PS 14012	102	25	50	PD 14012	102	25	100	PT 14012	102	25	150
13	174,2	159,18	PS 14013	114	25	50	PD 14013	114	25	100	PT 14013	114	25	150
14	186,2	171,22	PS 14014	128	25	50	PD 14014	128	25	100	PT 14014	128	25	150
15	198,2	183,26	PS 14015	140	25	50	PD 14015	140	25	100	PT 14015	140	25	150
16	210,3	195,30	PS 14016	140*	25	55	PD 14016	140*	25	100	PT 14016	140*	25	150
17	222,3	207,34	PS 14017	140*	25	55	PD 14017	150*	25	100	PT 14017	150*	25	150
18	234,3	219,42	PS 14018	140*	25	55	PD 14018	160*	25	100	PT 14018	160*	25	150
19	246,5	231,49	PS 14019	140*	25	55	PD 14019	160*	25	100	PT 14019	160*	25	150
20	258,6	243,57	PS 14020	140*	25	55	PD 14020	160*	25	100	PT 14020	160*	25	150
21	270,6	255,65	PS 14021	150*	25	60	PD 14021	160*	25	100	PT 14021	160*	30	150
22	282,7	267,73	PS 14022	150*	25	60	PD 14022	160*	25	100	PT 14022	160*	30	150
23	294,8	279,80	PS 14023	150*	25	60	PD 14023	160*	25	100	PT 14023	160*	30	150
24	306,8	291,88	PS 14024	150*	25	60	PD 14024	160*	25	100	PT 14024	160*	30	150
25	319,0	304,00	PS 14025	150*	25	60	PD 14025	160*	25	100	PT 14025	160*	30	150
26	331,0	316,08	PS 14026	160*	30	60	PD 14026	160*	30	100	PT 14026	160*	30	150
27	343,2	328,19	PS 14027	160*	30	60	PD 14027	160*	30	100	PT 14027	160*	30	150
28	355,2	340,27	PS 14028	160*	30	60	PD 14028	160*	30	100	PT 14028	160*	30	150
29	367,3	352,38	PS 14029	160*	30	60	PD 14029	160*	30	100	PT 14029	160*	30	150
30	379,5	364,50	PS 14030	160*	30	60	PD 14030	160*	30	100	PT 14030	160*	30	150
31	391,6	376,62	PS 14031	160*	30	60	PD 14031	170*	30	100	PT 14031	170*	40	150
32	403,7	388,69	PS 14032	160*	30	60	PD 14032	170*	30	100	PT 14032	170*	40	150
33	415,8	400,81	PS 14033	160*	30	60	PD 14033	170*	30	100	PT 14033	170*	40	150
34	427,8	412,93	PS 14034	160*	30	60	PD 14034	170*	30	100	PT 14034	170*	40	150
35	440,0	425,04	PS 14035	160*	30	60	PD 14035	170*	30	100	PT 14035	170*	40	150
36	452,0	437,16	PS 14036	160*	30	60	PD 14036	170*	30	100	PT 14036	170*	40	150
37	464,2	449,27	PS 14037	160*	30	60	PD 14037	170*	30	100	PT 14037	170*	40	150
38	476,2	461,39	PS 14038	160*	30	60	PD 14038	170*	30	100	PT 14038	170*	40	150
39	488,5	473,50	PS 14039	160*	30	60	PD 14039	170*	30	100	PT 14039	170*	40	150
40	500,6	485,62	PS 14040	160*	30	60	PD 14040	170*	30	100	PT 14040	170*	40	150
42	524,7	509,85	PS 14042	168*	30	99								
45	561,2	546,20	PS 14045	168*	30	99	PD 14045	180*	40	133	PT 14045	200*	40	153
46	573,3	558,32	PS 14046	168*	30	99								
48	597,4	582,55	PS 14048	168*	30	99								
50	621,7	606,78	PS 14050	168*	30	99	PD 14050	180*	40	133	PT 14050	200*	40	153
57	706,5	691,73	PS 14057	168*	30	99	PD 14057	180*	40	133	PT 14057	200*	40	153
60	742,8	727,97	PS 14060	168*	30	99								
76	936,9	921,98	PS 14076	178*	40	118	PD 14076	200*	40	133	PT 14076	220*	40	155
95	1167,3	1152,33	PS 14095	178*	40	118								

Pignoni per catene semplici, doppie e triple a rulli secondo: DIN 8187 - ISO/R 606

Sprockets for simplex, duplex and triplex chain to: DIN 8187 - ISO/R 606

Kettenräder mit einseitiger Nabe für Simplex- Duplex- Triplex-Rollenkette nach: DIN 8187 - ISO/R 606

Pignons avec moyeu déporté pour chaînes simples, doubles et triples à rouleaux suivant les normes: DIN 8187 - ISO/R 606

Piñones para cadena simple, doble y triple de rodillos segun las normas: DIN 8187 - ISO/R 606

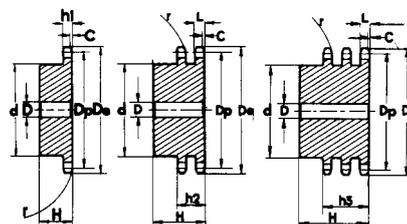

**1"3/4 x 1"1/4**

**24B - 1-2-3 38,1 x 25,4 mm**

CATENA	CHAIN	KETTE	CHAÎNE	CADENA	ISO mm
Passo	Pitch	Teilung	Pas	Paso	<b>44,45</b>
Larghezza interna	Internal width	Innere Breite	Largeur interieure	Ancho interno	<b>30,99</b>
Rullo ø	Roller ø	Rollen ø	ø du rouleau	Rodillo ø	<b>27,94</b>
PIGNONE	SPROCKETS	KETTENRÄDER	PIGNONS	PIÑONES	ISO mm
Raggio dente r	Tooth radius r	Radius r	Rayon de denture r	Radio diente r	<b>44,0</b>
Larghezza raggio C	Radius width C	Breite C	Largeur de rayon C	Ancho radio C	<b>5,0</b>
Largh. dente h <sub>1</sub>	Tooth width h <sub>1</sub>	Zahnbreite h <sub>1</sub>	Larg. de denture h <sub>1</sub>	Ancho diente h <sub>1</sub>	<b>h<sub>1</sub> 29,4</b>
Largh. dente L	Tooth width L	Zahnbreite L	Larg. de denture L	Ancho diente L	<b>L 28,8</b>
Largh. dente h <sub>2</sub>	Tooth width h <sub>2</sub>	Zahnbreite h <sub>2</sub>	Larg. de denture h <sub>2</sub>	Ancho diente h <sub>2</sub>	<b>h<sub>2</sub> 88,4</b>
Largh. dente h <sub>3</sub>	Tooth width h <sub>3</sub>	Zahnbreite h <sub>3</sub>	Larg. de denture h <sub>3</sub>	Ancho diente h <sub>3</sub>	<b>h<sub>3</sub> 148,0</b>
Altezza totale H	Full height H	Gesamt Höhe H	Hauteur totale H	Altura total H	<b>H -</b>

Materiale C 45 E UNI EN 10083-1	Material C 45 E UNI EN 10083-1	Werkstoff C 45 E UNI EN 10083-1	Matière C 45 E UNI EN 10083-1	Material C 45 E UNI EN 10083-1
*Tipi costruiti con mozzo saldato: materiale Fe	*With welded hub: material Fe	*Typen mit eingeschweisster Nabe: Werkstoff Fe	*Tipos avec moyeu soudé: matière Fe	*Tipos con nucleo soldado: material Fe

Z	D <sub>e</sub>	D <sub>p</sub>	PS				PD				PT			
			cod.	d	D	H	cod.	d	D	H	cod.	d	D	H
8	132,0	116,15	PS 15008	74	25	70	PD 15008	74	25	120	PT 15008	74	30	180
9	148,4	129,96	PS 15009	88	25	70	PD 15009	88	25	120	PT 15009	88	30	180
10	162,3	143,85	PS 15010	100	25	70	PD 15010	100	25	120	PT 15010	100	30	180
11	176,3	157,77	PS 15011	112	25	70	PD 15011	112	25	120	PT 15011	112	30	180
12	189,3	171,74	PS 15012	125	25	70	PD 15012	125	25	120	PT 15012	125	30	180
13	204,2	185,75	PS 15013	130*	25	70	PD 15013	130*	25	120	PT 15013	130*	30	180
14	218,2	199,76	PS 15014	130*	25	70	PD 15014	130*	25	120	PT 15014	130*	30	180
15	232,3	213,79	PS 15015	145*	25	70	PD 15015	145*	30	120	PT 15015	145*	30	180
16	246,3	227,84	PS 15016	160*	30	75	PD 15016	160*	30	120	PT 15016	160*	30	180
17	260,0	241,90	PS 15017	160*	30	75	PD 15017	160*	30	120	PT 15017	160*	30	180
18	274,0	255,98	PS 15018	160*	30	75	PD 15018	160*	30	120	PT 15018	160*	30	180
19	289,0	270,06	PS 15019	160*	30	75	PD 15019	180*	30	120	PT 15019	180*	30	180
20	303,0	284,15	PS 15020	160*	30	75	PD 15020	180*	30	120	PT 15020	180*	30	180
21	317,0	298,24	PS 15021	170*	30	75	PD 15021	180*	30	120	PT 15021	180*	30	180
22	331,0	312,34	PS 15022	170*	30	75	PD 15022	180*	30	120	PT 15022	180*	30	180
23	345,0	326,44	PS 15023	170*	30	75	PD 15023	180*	30	120	PT 15023	180*	30	180
24	359,0	340,55	PS 15024	170*	30	75	PD 15024	180*	30	120	PT 15024	180*	30	180
25	373,0	354,66	PS 15025	170*	30	75	PD 15025	180*	30	120	PT 15025	180*	40	180
26	387,0	368,77	PS 15026	170*	30	75	PD 15026	180*	30	120	PT 15026	180*	40	180
27	401,0	382,88	PS 15027	170*	30	75	PD 15027	180*	30	120	PT 15027	180*	40	180
28	416,0	397,00	PS 15028	170*	30	75	PD 15028	180*	30	120	PT 15028	180*	40	180
29	430,0	411,12	PS 15029	170*	30	75	PD 15029	180*	30	120	PT 15029	180*	40	180
30	444,0	425,24	PS 15030	170*	30	75	PD 15030	180*	30	120	PT 15030	180*	40	180
31	458,0	439,37	PS 15031	180*	30	75	PD 15031	200*	30	120	PT 15031	200*	40	180
32	472,0	453,49	PS 15032	180*	30	75	PD 15032	200*	30	120	PT 15032	200*	40	180
33	486,0	467,62	PS 15033	180*	30	75	PD 15033	200*	30	120	PT 15033	200*	40	180
34	500,0	481,75	PS 15034	180*	30	75	PD 15034	200*	30	120	PT 15034	200*	40	180
35	514,0	495,88	PS 15035	180*	30	75	PD 15035	200*	30	120	PT 15035	200*	40	180
36	529,0	510,01	PS 15036	180*	30	75	PD 15036	200*	30	120	PT 15036	200*	40	180
37	543,0	524,13	PS 15037	180*	30	75	PD 15037	200*	30	120	PT 15037	200*	40	180
38	557,0	538,27	PS 15038	180*	30	75	PD 15038	200*	30	120	PT 15038	200*	40	180
39	571,0	552,40	PS 15039	180*	30	75	PD 15039	200*	30	120	PT 15039	200*	40	180
40	585,0	566,54	PS 15040	180*	30	75	PD 15040	200*	30	120	PT 15040	200*	40	180
45	656,0	637,22	PS15045	180*	30	75	PD 15045	200*	40	150	PT15045	200*	40	209
50	726,0	707,91	PS15050	180*	30	75	PD 15050	200*	40	150				
57	825,0	806,90	PS15057	180*	40	123	PD 15057	200*	40	150	PT15057	200*	40	209
60	869,0	849,32	PS15060	180*	40	123								
76	1095,0	1075,62	PS15076	180*	40	123	PD 15076	200*	40	150	PT15076	238*	40	217

Pignoni per catene semplici, doppie e triple a rulli secondo: DIN 8187 - ISO/R 606

Sprockets for simplex, duplex and triplex chain to: DIN 8187 - ISO/R 606

Kettenräder mit einseitiger Nabe für Simplex- Duplex- Triplex-Rollenkette nach: DIN 8187 - ISO/R 606

Pignons avec moyeu déporté pour chaînes simples, doubles et triples à rouleaux suivant les normes: DIN 8187 - ISO/R 606

Piñones para cadena simple, doble y triple de rodillos según las normas: DIN 8187 - ISO/R 606

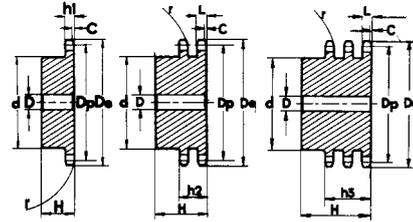

## 2" x 1 1/4

## 32B - 1-2-3 50,8 x 30,99 mm

CATENA	CHAIN	KETTE	CHAÎNE	CADENA	ISO mm
Passo	Pitch	Teilung	Pas	Paso	<b>50,80</b>
Larghezza interna	Internal width	Innere Breite	Largeur interieure	Ancho interno	<b>30,99</b>
Rullo ø	Roller ø	Rollen ø	ø du rouleau	Rodillo ø	<b>29,21</b>
PIGNONE	SPROCKETS	KETTENRÄDER	PIGNONS	PIÑONES	ISO mm
Raggio dente r	Tooth radius r	Radius r	Rayon de denture r	Radio diente r	<b>r 51,0</b>
Larghezza raggio C	Radius width C	Breite C	Largeur de rayon C	Ancho radio C	<b>C 6,0</b>
Largh. dente h <sub>1</sub>	Tooth width h <sub>1</sub>	Zahnbreite h <sub>1</sub>	Larg. de denture h <sub>1</sub>	Ancho diente h <sub>1</sub>	<b>h<sub>1</sub> 29,4</b>
Largh. dente L	Tooth width L	Zahnbreite L	Larg. de denture L	Ancho diente L	<b>L 28,8</b>
Largh. dente h <sub>2</sub>	Tooth width h <sub>2</sub>	Zahnbreite h <sub>2</sub>	Larg. de denture h <sub>2</sub>	Ancho diente h <sub>2</sub>	<b>h<sub>2</sub> 87,4</b>
Largh. dente h <sub>3</sub>	Tooth width h <sub>3</sub>	Zahnbreite h <sub>3</sub>	Larg. de denture h <sub>3</sub>	Ancho diente h <sub>3</sub>	<b>h<sub>3</sub> 146,0</b>
Altezza totale H	Full height H	Gesamt Höhe H	Hauteur totale H	Altura total H	<b>H -</b>

**Materiale C 45 E  
UNI EN 10083-1**

\*Tipi costruiti con mozzo saldato:  
materiale Fe

**Material C 45 E  
UNI EN 10083-1**

\*With welded hub:  
material Fe

**Werkstoff C 45 E  
UNI EN 10083-1**

\*Typen mit eingeschweisster  
Nabe: Werkstoff Fe

**Matière C 45 E  
UNI EN 10083-1**

\*Tipos avec moyeu soudé:  
matière Fe

**Material C 45 E  
UNI EN 10083-1**

\*Tipos con nucleo soldado:  
material Fe

Z	D <sub>e</sub>	D <sub>p</sub>	PS				PD				PT			
			cod.	d	D	H	cod.	d	D	H	cod.	d	D	H
8	153,2	132,74	PS 16008	82	25	80	PD 16008	82	30	120	PT 16008	82	30	180
9	169,0	148,54	PS 16009	88	25	80	PD 16009	88	30	120	PT 16009	88	30	180
10	185,0	164,39	PS 16010	104	25	80	PD 16010	104	30	120	PT 16010	104	30	180
11	200,8	180,31	PS 16011	120	30	80	PD 16011	120	30	120	PT 16011	120	30	180
12	216,8	196,29	PS 16012	133*	30	80	PD 16012	133*	30	120	PT 16012	133*	30	180
13	232,8	212,29	PS 16013	145*	30	80	PD 16013	145*	30	120	PT 16013	145*	30	180
14	248,8	228,29	PS 16014	160*	30	80	PD 16014	160*	30	120	PT 16014	160*	30	180
15	264,8	244,30	PS 16015	160*	30	80	PD 16015	160*	30	120	PT 16015	160*	30	180
16	280,9	260,40	PS 16016	160*	30	90	PD 16016	160*	30	120	PT 16016	160*	30	180
17	296,9	276,46	PS 16017	170*	30	90	PD 16017	180*	30	120	PT 16017	180*	30	180
18	313,0	292,55	PS 16018	170*	30	90	PD 16018	180*	30	120	PT 16018	180*	30	180
19	329,1	308,66	PS 16019	170*	30	90	PD 16019	200*	30	120	PT 16019	200*	30	180
20	345,2	324,71	PS 16020	180*	30	90	PD 16020	200*	30	120	PT 16020	200*	30	180
21	361,3	340,82	PS 16021	180*	30	90	PD 16021	200*	30	120	PT 16021	200*	40	180
22	377,5	356,98	PS 16022	180*	30	90	PD 16022	200*	30	120	PT 16022	200*	40	180
23	393,6	373,08	PS 16023	180*	30	90	PD 16023	200*	30	120	PT 16023	200*	40	180
24	409,7	389,18	PS 16024	180*	30	90	PD 16024	200*	30	120	PT 16024	200*	40	180
25	425,8	405,33	PS 16025	180*	30	90	PD 16025	200*	30	120	PT 16025	200*	40	180
26	441,9	421,44	PS 16026	180*	30	90	PD 16026	200*	30	120	PT 16026	200*	40	180
27	458,1	437,59	PS 16027	180*	30	90	PD 16027	200*	30	120	PT 16027	200*	40	180
28	474,2	453,69	PS 16028	180*	30	90	PD 16028	200*	30	120	PT 16028	200*	40	180
29	492,0	469,85	PS 16029	180*	30	90								
30	506,5	486,00	PS 16030	180*	30	90	PD 16030	200*	30	120	PT 16030	200*	40	180
32	538,8	518,27	PS 16032	180*	30	90								
35	589,5	566,71	PS 16035	180*	30	90								
38	635,5	615,16	PS 16038	180*	30	90								
40	670,3	647,47	PS 16040	180*	30	90								
45	751,0	728,24	PS16045	218*	40	123	PD 16045	220*	40	148	PT 16045	220*	40	207
50	831,8	809,04	PS16050	218*	40	123	PD 16050	220*	40	148	PT 16050	220*	40	207
57	945,0	922,16	PS16057	218*	40	123	PD 16057	220*	40	148	PT 16057	220*	40	207
60	993,4	970,65	PS16060	218*	40	123								
76	1252,0	1229,27	PS16076	218*	40	123	PD 16076	220*	40	148	PT 16076	238*	40	216

# Pignoni semplici temperati ad induzione sui denti (45 ÷ 55 HRC)

## Simplex sprockets with hardened teeth (45 ÷ 55 HRC)

### Gehärtete einfach Kettenräder (45 ÷ 55 HRC)

#### Pignons simples avec denture trempée haute fréquence (45 ÷ 55 HRC)

#### Piñones simples templados por inducción en los dientes (45 ÷ 55 HRC)



Pignoni per catene semplici, a rulli DIN 8187 - ISO/R 606

Sprockets for simplex, duplex and triplex chain to: DIN 8187 - ISO/R 606

Kettenräder mit einseitiger Nabe für Simplex-Rollenkette nach: DIN 8187 - ISO/R 606

Pignons avec moyeu déporté pour chaînes simples, à rouleaux suivant les normes: DIN 8187 - ISO/R 606

Piñones para cadena, de rodillos según las normas: DIN 8187 - ISO/R 606

**Materiale C 45 E**  
UNI EN 10083-1

**Material C 45 E**  
UNI EN 10083-1

**Werkstoff C 45 E**  
UNI EN 10083-1

**Matière C 45 E**  
UNI EN 10083-1

**Material C 45 E**  
UNI EN 10083-1

### 3/8" x 7/32" - 06 B1

Z	D <sub>e</sub>	D <sub>p</sub>	PS			
			cod.	d	D	H
13	43,0	39,80	PS 05T13	28	10	25
14	46,3	42,80	PS 05T14	31	10	25
15	49,3	45,81	PS 05T15	34	10	25
16	52,3	48,82	PS 05T16	37	10	28
17	55,3	51,83	PS 05T17	40	10	28
18	58,3	54,85	PS 05T18	43	10	28
19	61,3	57,87	PS 05T19	45	10	28
20	64,3	60,89	PS 05T20	46	10	28
21	68,0	63,91	PS 05T21	48	12	28
22	71,0	66,93	PS 05T22	50	12	28
23	73,5	69,95	PS 05T23	52	12	28
24	77,0	72,97	PS 05T24	54	12	28
25	80,0	76,00	PS 05T25	57	12	28
30	94,7	91,12	PS 05T30	60	12	28

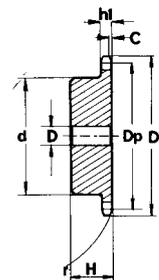
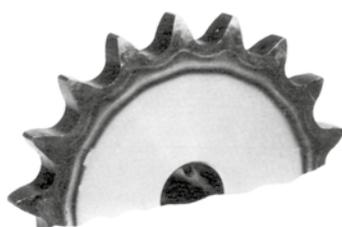

### 1/2" x 5/16" - 08 B1

Z	D <sub>e</sub>	D <sub>p</sub>	PS			
			cod.	d	D	H
12	53,0	49,07	PS 09T12	33	10	28
13	57,4	53,06	PS 09T13	37	10	28
14	61,8	57,07	PS 09T14	41	10	28
15	65,5	61,09	PS 09T15	45	10	28
16	69,5	65,10	PS 09T16	50	12	28
17	73,6	69,11	PS 09T17	52	12	28
18	77,8	73,14	PS 09T18	56	12	28
19	81,7	77,16	PS 09T19	60	12	28
20	85,8	81,19	PS 09T20	64	12	28
21	89,7	85,22	PS 09T21	68	14	28
22	93,8	89,24	PS 09T22	70	14	28
23	98,2	93,27	PS 09T23	70	14	28
24	101,8	97,29	PS 09T24	70	14	28
25	105,8	101,33	PS 09T25	70	14	28
30	126,1	121,50	PS 09T30	80	16	30

### 3/4" x 7/16" - 12 B1

Z	D <sub>e</sub>	D <sub>p</sub>	PS			
			cod.	d	D	H
12	81,5	73,60	PS 11T12	52	14	35
13	87,5	79,59	PS 11T13	58	14	35
14	93,6	85,61	PS 11T14	64	14	35
15	99,8	91,63	PS 11T15	70	14	35
16	105,5	97,65	PS 11T16	75	16	35
17	111,5	103,67	PS 11T17	80	16	35
18	118,0	109,71	PS 11T18	80	16	35
19	124,2	115,75	PS 11T19	80	16	35
20	129,7	121,78	PS 11T20	80	16	35
21	136,0	127,82	PS 11T21	90	20	40
22	141,8	133,86	PS 11T22	90	20	40
23	149,0	139,90	PS 11T23	90	20	40
24	153,9	145,94	PS 11T24	90	20	40
25	160,0	152,00	PS 11T25	90	20	40
30	190,5	182,25	PS 11T30	95	20	40

### 5/8" x 3/8" - 10 B1

Z	D <sub>e</sub>	D <sub>p</sub>	PS			
			cod.	d	D	H
12	68,0	61,34	PS 10T12	42	12	30
13	73,0	66,32	PS 10T13	47	12	30
14	78,0	71,34	PS 10T14	52	12	30
15	83,0	76,36	PS 10T15	57	12	30
16	88,0	81,37	PS 10T16	60	14	30
17	93,0	86,39	PS 10T17	60	14	30
18	98,3	91,42	PS 10T18	70	14	30
19	103,3	96,45	PS 10T19	70	14	30
20	108,4	101,49	PS 10T20	75	14	30
21	113,4	106,52	PS 10T21	75	16	30
22	118,0	111,55	PS 10T22	80	16	30
23	123,4	116,58	PS 10T23	80	16	30
24	128,3	121,62	PS 10T24	80	16	30
25	134,0	126,66	PS 10T25	80	16	30
30	158,8	151,87	PS 10T30	90	20	35

### 1" x 17,02" - 16 B1

Z	D <sub>e</sub>	D <sub>p</sub>	PS			
			cod.	d	D	H
12	109,0	98,14	PS 12T12	69	16	40
13	117,0	116,12	PS 12T13	78	16	40
14	125,0	114,15	PS 12T14	84	16	40
15	133,0	122,17	PS 12T15	92	16	40
16	141,0	130,20	PS 12T16	100	20	45
17	149,0	138,22	PS 12T17	100	20	45
18	157,0	146,28	PS 12T18	100	20	45
19	165,2	154,33	PS 12T19	100	20	45
20	173,2	162,38	PS 12T20	100	20	45
21	181,2	170,43	PS 12T21	110	20	50
22	189,3	178,48	PS 12T22	110	20	50
23	197,5	186,53	PS 12T23	110	20	50
24	205,5	194,59	PS 12T24	110	20	50
25	213,5	202,66	PS 12T25	110	20	50
30	254,0	243,00	PS 12T30	120	20	50

**Pignoni semplici in acciaio inox AISI 304 L**  
**Simplex sprockets in stainless-steel 304 L**  
**Einfach Kettenräder aus Rostfreiem Stahl AISI 304 L**  
**Pignons simples en acier inoxydable AISI 304 L**  
**Piñones simples en acero inoxidable AISI 304 L**

Pignoni per catene semplici, a rulli DIN 8187 - ISO/R 606

Sprockets for simplex, chain to DIN 8187 - ISO/R 606

Kettenräder mit einseitiger Nabe für Simplex-Rollenkette nach: DIN 8187 - ISO/R 606

Pignons avec moyeu déporté pour chaînes simples, à rouleaux suivant les normes: DIN 8187 - ISO/R 606

Piñones para cadena, de rodillos según las normas: DIN 8187 - ISO/R 606

### 3/8" x 7/32" - 06 B1

Z	D <sub>e</sub>	D <sub>p</sub>	PS			
			cod.	d	D	H
13	43,0	39,80	PS 05x13	28	10	25
14	46,3	42,80	PS 05x14	31	10	25
15	49,3	45,81	PS 05x15	34	10	25
16	52,3	48,82	PS 05x16	37	10	28
17	55,3	51,83	PS 05x17	40	10	28
18	58,3	54,85	PS 05x18	43	10	28
19	61,3	57,85	PS 05x19	45	10	28
20	64,3	60,89	PS 05x20	46	10	28
21	68,0	63,91	PS 05x21	48	12	28
22	71,0	66,93	PS 05x22	50	12	28
23	73,5	69,95	PS 05x23	52	12	28
24	77,0	72,97	PS 05x24	54	12	28
25	80,0	76,00	PS 05x25	57	12	28
30	94,7	91,12	PS 05x30	60	12	28

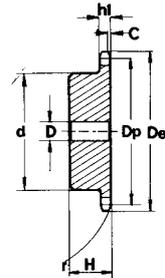

### 1/2" x 5/16" - 08 B1

Z	D <sub>e</sub>	D <sub>p</sub>	PS			
			cod.	d	D	H
12	53,0	49,03	PS 09x12	33	10	28
13	57,4	53,06	PS 09x13	37	10	28
14	61,8	57,07	PS 09x14	41	10	28
15	65,5	61,09	PS 09x15	45	10	28
16	69,5	65,10	PS 09x16	50	12	28
17	73,6	69,11	PS 09x17	52	12	28
18	77,8	73,14	PS 09x18	56	12	28
19	81,7	77,16	PS 09x19	60	12	28
20	85,8	81,19	PS 09x20	64	12	28
21	89,7	85,22	PS 09x21	68	14	28
22	93,8	89,24	PS 09x22	70	14	28
23	98,2	93,27	PS 09x23	70	14	28
24	101,8	97,29	PS 09x24	70	14	28
25	105,8	101,33	PS 09x25	70	14	28
26	110,0	105,36	PS 09x26	70	16	30
30	126,1	121,50	PS 09x30	80	16	30

### 3/4" x 7/16" - 12 B1

Z	D <sub>e</sub>	D <sub>p</sub>	PS			
			cod.	d	D	H
12	81,5	73,60	PS 11T12	52	14	35
13	87,5	79,59	PS 11T13	58	14	35
14	93,6	85,61	PS 11T14	64	14	35
15	99,8	91,63	PS 11T15	70	14	35
16	105,5	97,65	PS 11T16	75	16	35
17	111,5	103,67	PS 11T17	80	16	35
18	118,0	109,71	PS 11T18	80	16	35
19	124,2	115,75	PS 11T19	80	16	35
20	129,7	121,78	PS 11T20	80	16	35
21	136,0	127,82	PS 11T21	90	20	40
22	141,8	133,86	PS 11T22	90	20	40
23	149,0	139,90	PS 11T23	90	20	40
24	153,9	145,94	PS 11T24	90	20	40
25	160,0	152,00	PS 11T25	90	20	40
30	190,5	182,25	PS 11T30	95	20	40

### 5/8" x 3/8" - 10 B1

Z	D <sub>e</sub>	D <sub>p</sub>	PS			
			cod.	d	D	H
12	68,0	61,34	PS 10T12	42	12	30
13	73,0	66,32	PS 10T13	47	12	30
14	78,0	71,34	PS 10T14	52	12	30
15	83,0	76,36	PS 10T15	57	12	30
16	88,0	81,37	PS 10T16	60	14	30
17	93,0	86,39	PS 10T17	60	14	30
18	98,3	91,42	PS 10T18	70	14	30
19	103,3	96,45	PS 10T19	70	14	30
20	108,4	101,49	PS 10T20	75	14	30
21	113,4	106,52	PS 10T21	75	16	30
22	118,0	111,55	PS 10T22	80	16	30
23	123,4	116,58	PS 10T23	80	16	30
24	128,3	121,62	PS 10T24	80	16	30
25	134,0	126,66	PS 10T25	80	16	30
30	158,8	151,87	PS 10T30	90	20	35

### 1" x 17,02" - 16 B1

Z	D <sub>e</sub>	D <sub>p</sub>	PS			
			cod.	d	D	H
12	109,0	98,14	PS 12T12	69	16	40
13	117,0	116,12	PS 12T13	78	16	40
14	125,0	114,15	PS 12T14	84	16	40
15	133,0	122,17	PS 12T15	92	16	40
16	141,0	130,20	PS 12T16	100	20	45
17	149,0	138,22	PS 12T17	100	20	45
18	157,0	146,28	PS 12T18	100	20	45
19	165,2	154,33	PS 12T19	100	20	45
20	173,2	162,38	PS 12T20	100	20	45
21	181,2	170,43	PS 12T21	110	20	50
22	189,3	178,48	PS 12T22	110	20	50
23	197,5	186,53	PS 12T23	110	20	50
24	205,5	194,59	PS 12T24	110	20	50
25	213,5	202,66	PS 12T25	110	20	50
30	254,0	243,00	PS 12T30	120	20	50



Agente corrosivo Corrosive agent / Ätzender Stoff Agent corrosif / Agente corrosivo	Concentrazione Concentration / Konzentration Concentration / Concentración %	Temperatura Temperature / Temperatur Température / Temperatura °C	<b>304 L</b>
Aceto / Vinegar		20	A
Acido acetico / Acetic acid	5-100	20	A
Acido butirrico / Butyric acid	50	Bollente-Boiling	C
Acido citrico / Citric acid	5-10	20-65	A
Acido cloridrico / Hydrochloric acid	5	20-65	A
Acido cromico / Chromic acid	15	Bollente-Boiling	A
Acido formico / Formic acid		20	E
Acido fosforico / Phosphoric acid	5	20	A
Acido lattico / Lactic acid	10	Bollente-Boiling	C
Acido nitrico / Nitric acid	10	20	A
Acido oleico / Oleic acid	10	50	B
Acido solforico / Sulphuric acid	1	20	A
Acido tartarico / Tartar acid	5-10	20	C
Acqua dolce / Water	5	20	A
Acqua marina / Sea water	5	65	B
Alcool etilico / Ethyl alcohol	10	20	A
Alcool metilico / Methyl alcohol	10	Bollente-Boiling	B
Ammoniaca / Aqua ammonia	5-50	20	A
Benzina / Gasoline	50	Bollente-Boiling	A
Birra / Beer	100	Bollente-Boiling	D
Caffè / Coffee	100	20	B
Carbonato di sodio / Sodium carbonate	5	20	A
Cloroformio / Chloroform	5	Bollente-Boiling	E
Cloruro ferrico / Ferric chloride	50	20	D
Cloruro di sodio / Sodium chloride	50	Bollente-Boiling	E
Cloruro di zinco / Zinc chloride	100	20	A
Gelatina / Gelatine	100	Bollente-Boiling	D
Glicerina / Glycerine	10	20-65	A
Idrossido di calcio / Hydroxide calcium			A
Ketchup / Kettchup			A
Latte / Milk		20-Bollente-Boiling	A
Mayonnaise / Mayonnaise		20	A
Sapone / Soap			C
Sciroppo / Syrup		65	A
Solfato di zinco / Zinc sulphate		20	A
Succhi di frutta / Fruit juice		20	A
Tiosolfato di sodio / Sodium thiosulfate			A
Tricloroetilene / Trichloroethylene		Bollente-Boiling	A
Vernici / Paint	5	20-65	A
Vino / Wine		20	B
Whisky / Whisky	1	20	D
Zucchero di canna / Cane sugar	5	20	A
	5-20	20-65	A
	5	20	A
			A
			A
	10-20	Bollente-Boiling	C
	50	Bollente-Boiling	A
		20	A
		65	A
		20	A
		20	A
			A
	5-100	20	A
			A
	5-10	20-65	C
	100	20	A
			A
			A
			A

**A:** ECCELLENTE (grado di corrosione sotto 0,0089 mm/mese) / EXCELLENT (corrosion rate below 0,0089 mm/month) / AUSGEZEICHNET: (Korrosionsgrad unter 0,0089 mm/Monat) / EXCELLENT: (taux de corrosion au-dessous de 0,0089 mm/mois) / EXCELENTE : (tasa de corrosion bajo 0,0089 mm/mes)  
**B:** SODDISFACENTE (grado di corrosione 0,0089-0,089 mm/mese) / SATISFACTORY (corrosion rate 0,0089-0,089 mm/month) / AUSREICHEND (Korrosionsgrad 0,0089-0,089 mm/Monat) / SATISFAISANT (taux de corrosion 0,0089-0,089 mm/mois) / SATISFACTORIO (tasa de corrosion 0,0089-0,089 mm/mes)  
**C:** MARGINALE (grado di corrosione 0,089-0,25 mm/mese) / MARGINAL (corrosion rate 0,089-0,25 mm/month) / GERING (Korrosionsgrad 0,089-0,25 mm/Monat) / MARGINAL (taux de corrosion 0,089-0,25 mm/mois) / MARGINAL (tasa de corrosion 0,089-0,25 mm/mes)  
**D:** INSODDISFACENTE (grado di corrosione 0,25-0,89 mm/mese) / UNSATISFACTORY (corrosion rate 0,25-0,89 mm/month) / UNBEFRIEDIGEND (Korrosionsgrad 0,25-0,89 mm/Monat) / INSATISFAISANT (taux de corrosion 0,25-0,89 mm/mois) / INSATISFACTORIO (tasa de corrosion 0,25-0,89 mm/mes)  
**E:** NON RACCOMANDABILE (grado di corrosione oltre 0,0089 mm/mese) / NOT RECOMMENDABLE (corrosion rate over 0,0089 mm/month) / NICHT EMPFEHLENSWERT: (Korrosionsgrad über 0,0089 mm/Monat) / NON RECOMMENDABLE: (taux de corrosion au-dessus de 0,0089 mm/mois) / NO RECOMENDABLE (tasa de corrosion mas de 0,0089 mm/mes)

Corone per catene semplici, a rulli secondo:  
DIN 8187 - ISO/R 606

**Corone tornite sui lati, dentate con creatore.**

Plate wheels for simplex chain to:  
DIN 8187 - ISO/R 606

**Plate Wheels turned on both sides and toothed by milling cutter.**

Kettenradscheiben für Simplex-Rollenkette nach:  
DIN 8187 - ISO/R 606

**Seitlich plan gedrehte, wälzgefräste Zahnkränze.**

Disques pour chaînes simples à rouleaux suivant les normes:  
DIN 8187 - ISO/R 606

**Disques tournés sur les flancs, dentés à la fraise.**

Discos para cadena simple de rodillos según:  
DIN 8187 - ISO/R 606

**Discos torneadas en los lados, dientes obtenidos con fresa madre.**

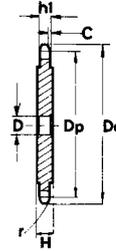

## 5 x 2,5 mm

## 03-1

CATENA:	CHAIN:	KETTE:	CHAÎNE:	CADENA:	ISO mm
Passo	Pitch	Teilung	Pas	Paso	<b>5,0</b>
Larghezza interna	Internal width	Innere Breite	Largeur interieure	Ancho interno	<b>2,5</b>
Rullo $\varnothing$	Roller $\varnothing$	Rollen $\varnothing$	$\varnothing$ du rouleau	Rodillo $\varnothing$	<b>3,2</b>

CORONE	PLATE WHEELS	KETTENRADSCHIEBEN	DISQUES	DISCOS	ISO mm
Raggio dente r	Tooth radius r	Radius r	Rayon de denture r	Radio diente r	<b>r</b> <b>5,0</b>
Larghezza raggio C	Radius width C	Breite C	Largeur de rayon C	Ancho radio C	<b>C</b> <b>0,6</b>
Largh. dente $h_1$	Tooth width $h_1$	Zahnbreite $h_1$	Larg. de denture $h_1$	Ancho diente $h_1$	<b><math>h_1</math></b> <b>2,3</b>
Largh. dente L	Tooth width L	Zahnbreite L	Larg. de denture L	Ancho diente L	<b>L</b> -
Largh. dente $h_2$	Tooth width $h_2$	Zahnbreite $h_2$	Larg. de denture $h_2$	Ancho diente $h_2$	<b><math>h_2</math></b> -
Largh. dente $h_3$	Tooth width $h_3$	Zahnbreite $h_3$	Larg. de denture $h_3$	Ancho diente $h_3$	<b><math>h_3</math></b> -
Altezza totale H	Full height H	Gesamt Höhe H	Hauteur totale H	Altura total H	<b>H</b> -

**A partire da Z = 51 il disco ruota viene maggiorato, H = 4 mm**

**From Z = 51 the width of the plate is increased, H = 4 mm**

**Ab Zähnezahl Z = 51 beträgt die Scheibendicke H = 4 mm**

**A partir de Z = 51 l'épaisseur du disque est augmenté H = 4 mm**

**A partir de Z = 51 el disco rueda para cadena queda aumentado, H = 4 mm**

Z	D <sub>e</sub>	D <sub>p</sub>	CS		Z	D <sub>e</sub>	D <sub>p</sub>	CS		Z	D <sub>e</sub>	D <sub>p</sub>	CS	
			cod.	D				cod.	D				cod.	D
8	15,2	13,06	CS 01008	4	32	53,2	51,01	CS 01032	8	56	91,3	89,17	CS 01056	10
9	16,8	14,62	CS 01009	4	33	54,8	52,60	CS 01033	8	57	92,9	90,76	CS 01057	10
10	18,3	16,18	CS 01010	4	34	56,3	54,19	CS 01034	8	58	94,5	92,35	CS 01058	10
11	19,9	17,75	CS 01011	5	35	57,9	55,78	CS 01035	8	59	96,1	93,94	CS 01059	10
12	21,5	19,32	CS 01012	5	36	59,5	57,37	CS 01036	8	60	97,7	95,53	CS 01060	10
13	23,0	20,89	CS 01013	5	37	61,1	58,96	CS 01037	8	62	100,9	98,72	CS 01062	12
14	24,6	22,47	CS 01014	5	38	62,7	60,54	CS 01038	8	64	104,1	101,90	CS 01064	12
15	26,2	24,04	CS 01015	5	39	64,3	62,13	CS 01039	8	65	105,6	103,49	CS 01065	12
16	27,8	25,63	CS 01016	6	40	65,9	63,73	CS 01040	8	66	107,2	105,08	CS 01066	12
17	29,4	27,20	CS 01017	6	41	67,5	65,31	CS 01041	8	68	110,4	108,26	CS 01068	12
18	30,9	28,79	CS 01018	6	42	69,1	66,91	CS 01042	8	70	113,6	111,44	CS 01070	12
19	32,5	30,38	CS 01019	6	43	70,6	68,49	CS 01043	8	72	116,8	114,63	CS 01072	12
20	34,1	31,96	CS 01020	6	44	72,2	70,09	CS 01044	8	75	121,6	119,40	CS 01075	12
21	35,7	33,54	CS 01021	8	45	73,8	71,68	CS 01045	8	76	123,1	120,99	CS 01076	12
22	37,3	35,13	CS 01022	8	46	75,4	73,27	CS 01046	8	78	126,3	124,17	CS 01078	12
23	38,9	36,72	CS 01023	8	47	77,0	74,86	CS 01047	8	80	129,5	127,35	CS 01080	12
24	40,5	38,30	CS 01024	8	48	78,6	76,45	CS 01048	8	85	137,5	135,31	CS 01085	14
25	42,0	39,89	CS 01025	8	49	80,2	78,03	CS 01049	8	90	145,4	143,27	CS 01090	14
26	43,6	41,48	CS 01026	8	50	81,8	79,63	CS 01050	8	95	153,4	151,22	CS 01095	14
27	45,2	43,07	CS 01027	8	51	83,4	81,22	CS 01051	10	100	161,3	159,18	CS 01100	14
28	46,8	44,65	CS 01028	8	52	85,0	82,81	CS 01052	10	110	177,2	175,09	CS 01110	14
29	48,4	46,25	CS 01029	8	53	86,6	84,40	CS 01053	10	114	183,6	181,46	CS 01114	14
30	50,0	47,83	CS 01030	8	54	88,1	85,97	CS 01054	10	120	193,2	191,01	CS 01120	14
31	51,5	49,42	CS 01031	8	55	89,7	87,58	CS 01055	10	125	201,1	198,96	CS 01125	14

Corone per catene semplici, a rulli secondo:  
DIN 8187 - ISO/R 606

**Corone tornite sui lati, dentate con creatore.**

Plate wheels for simplex chain to:  
DIN 8187 - ISO/R 606

**Plate Wheels turned on both sides and toothed by milling cutter.**

Kettenradscheiben für Simplex-Rollenkette nach:  
DIN 8187 - ISO/R 606

**Seitlich plan gedrehte, wälzgefräste Zahnkränze.**

Disques pour chaînes simples à rouleaux suivant les normes:  
DIN 8187 - ISO/R 606

**Disques tournés sur les flancs, dentés à la fraise.**

Discos para cadena simple de rodillos según:  
DIN 8187 - ISO/R 606

**Discos torneadas en los lados, dientes obtenidos con fresa madre.**

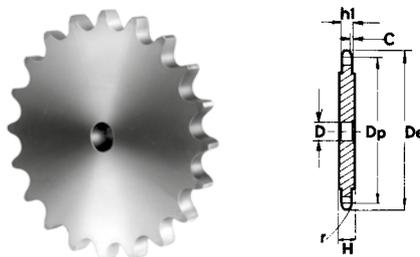

**6 x 2,8 mm**

**04-1**

CATENA:	CHAIN:	KETTE:	CHAÎNE:	CADENA:	ISO mm
Passo	Pitch	Teilung	Pas	Paso	<b>6,0</b>
Larghezza interna	Internal width	Innere Breite	Largeur interieure	Ancho interno	<b>2,8</b>
Rullo $\varnothing$	Roller $\varnothing$	Rollen $\varnothing$	$\varnothing$ du rouleau	Rodillo $\varnothing$	<b>4,0</b>

CORONE	PLATE WHEELS	KETTENRADSCHIEBEN	DISQUES	DISCOS	ISO mm
Raggio dente r	Tooth radius r	Radius r	Rayon de denture r	Radio diente r	<b>r 6,0</b>
Larghezza raggio C	Radius width C	Breite C	Largeur de rayon C	Ancho radio C	<b>C 0,7</b>
Largh. dente $h_1$	Tooth width $h_1$	Zahnbreite $h_1$	Larg. de denture $h_1$	Ancho diente $h_1$	<b><math>h_1</math> 2,6</b>
Largh. dente L	Tooth width L	Zahnbreite L	Larg. de denture L	Ancho diente L	<b>L -</b>
Largh. dente $h_2$	Tooth width $h_2$	Zahnbreite $h_2$	Larg. de denture $h_2$	Ancho diente $h_2$	<b><math>h_2</math> -</b>
Largh. dente $h_3$	Tooth width $h_3$	Zahnbreite $h_3$	Larg. de denture $h_3$	Ancho diente $h_3$	<b><math>h_3</math> -</b>
Altezza totale H	Full height H	Gesamt Höhe H	Hauteur totale H	Altura total H	<b>H -</b>

**A partire da Z = 51 il disco ruota viene maggiorato, H = 4 mm**

**From Z = 51 the width of the plate is increased, H = 4 mm**

**Ab Zähnezahl Z = 51 beträgt die Scheibendicke H = 4 mm**

**A partir de Z = 51 l'épaisseur du disque est augmenté H = 4 mm**

**A partir de Z = 51 el disco rueda para cadena queda aumentado, H = 4 mm**

Z	De	Dp	CS		Z	De	Dp	CS		Z	De	Dp	CS	
			cod.	D				cod.	D				cod.	D
8	18,0	15,67	CS 02008	5	32	63,6	61,21	CS 02032	8	56	109,5	107,00	CS 02056	12
9	19,9	17,54	CS 02009	5	33	65,5	63,11	CS 02033	8	57	111,4	108,93	CS 02057	12
10	21,7	19,42	CS 02010	6	34	67,4	65,02	CS 02034	8	58	113,3	110,82	CS 02058	12
11	23,7	21,30	CS 02011	6	35	69,3	66,93	CS 02035	8	59	115,2	112,71	CS 02059	12
12	25,4	23,18	CS 02012	6	36	71,2	68,84	CS 02036	8	60	117,1	114,62	CS 02060	12
13	27,3	25,05	CS 02013	8	37	73,1	70,75	CS 02037	8	62	120,9	118,45	CS 02062	14
14	29,2	26,96	CS 02014	8	38	75,0	72,66	CS 02038	8	64	124,7	122,27	CS 02064	14
15	31,1	28,86	CS 02015	8	39	76,9	74,56	CS 02039	8	65	126,6	124,18	CS 02065	14
16	33,0	30,76	CS 02016	8	40	78,9	76,47	CS 02040	8	66	128,5	126,09	CS 02066	14
17	35,0	32,65	CS 02017	8	41	80,8	78,38	CS 02041	10	68	132,4	129,91	CS 02068	14
18	36,9	34,55	CS 02018	8	42	82,7	80,28	CS 02042	10	70	136,2	133,73	CS 02070	14
19	38,8	36,44	CS 02019	8	43	84,7	82,19	CS 02043	10	72	140,0	137,55	CS 02072	16
20	40,7	38,34	CS 02020	8	44	86,6	84,10	CS 02044	10	75	145,7	143,28	CS 02075	16
21	42,6	40,25	CS 02021	8	45	88,5	86,01	CS 02045	10	76	147,6	145,19	CS 02076	16
22	44,5	42,16	CS 02022	8	46	90,4	87,92	CS 02046	10	78	151,5	149,01	CS 02078	16
23	46,4	44,06	CS 02023	8	47	92,3	89,83	CS 02047	10	80	155,3	152,82	CS 02080	16
24	48,3	45,96	CS 02024	8	48	94,2	91,74	CS 02048	10	85	164,8	162,37	CS 02085	16
25	50,2	47,87	CS 02025	8	49	96,1	93,64	CS 02049	10	90	174,4	171,92	CS 02090	16
26	52,1	49,77	CS 02026	8	50	98,0	95,55	CS 02050	10	95	183,9	181,47	CS 02095	16
27	54,0	51,67	CS 02027	8	51	99,9	97,47	CS 02051	12	100	193,5	191,01	CS 02100	16
28	55,9	53,58	CS 02028	8	52	101,8	99,37	CS 02052	12	110	211,6	210,11	CS 02110	16
29	57,8	55,50	CS 02029	8	53	103,7	101,27	CS 02053	12	114	220,2	217,75	CS 02114	16
30	59,8	57,42	CS 02030	8	54	105,6	103,17	CS 02054	12	120	231,7	229,20	CS 02120	16
31	61,7	59,31	CS 02031	8	55	107,6	105,08	CS 02055	12	125	241,2	238,75	CS 02125	16

Corone per catene semplici, a rulli secondo: DIN 8188 - ISO/R 606 - ANSI B29,1

**Corone tornite sui lati, dentate con creatore.**

Plate wheels for simplex chain to: DIN 8188 - ISO/R 606 - ANSI B29,1

**Plate Wheels turned on both sides and toothed by milling cutter.**

Kettenradscheiben für Simplex-Rollenkette nach: DIN 8188 - ISO/R 606 - ANSI B29,1

**Seitlich plan gedrehte, wälzgefräste Zahnkränze.**

Disques pour chaînes simples à rouleaux suivant les normes: DIN 8188 - ISO/R 606 - ANSI B29,1

**Disques tournés sur les flancs, dentés à la fraise.**

Discos para cadena simple de rodillos según: DIN 8188 - ISO/R 606 - ANSI B29,1

**Discos torneadas en los lados, dientes obtenidos con fresa madre.**

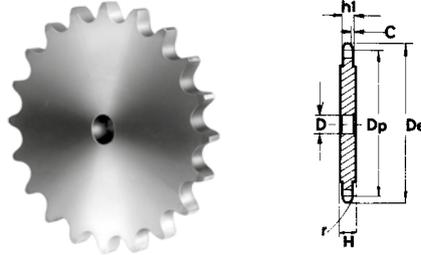

**1/4" x 1/8"**

**ASA 25-1 6,35 x 3,18 mm**

CATENA:	CHAIN:	KETTE:	CHAÎNE:	CADENA:	ASA 25 mm
Passo	Pitch	Teilung	Pas	Paso	<b>6,35</b>
Larghezza interna	Internal width	Innere Breite	Largeur interieure	Ancho interno	<b>3,18</b>
Rullo $\varnothing$	Roller $\varnothing$	Rollen $\varnothing$	$\varnothing$ du rouleau	Rodillo $\varnothing$	<b>3,30</b>

CORONE	PLATE WHEELS	KETTENRADSCHIEBEN	DISQUES	DISCOS	ASA mm
Raggio dente r	Tooth radius r	Radius r	Rayon de denture r	Radio diente r	<b>r</b> <b>6,4</b>
Larghezza raggio C	Radius width C	Breite C	Largeur de rayon C	Ancho radio C	<b>C</b> <b>0,7</b>
Largh. dente $h_1$	Tooth width $h_1$	Zahnbreite $h_1$	Larg. de denture $h_1$	Ancho diente $h_1$	<b><math>h_1</math></b> <b>2,9</b>
Largh. dente L	Tooth width L	Zahnbreite L	Larg. de denture L	Ancho diente L	<b>L</b> -
Largh. dente $h_2$	Tooth width $h_2$	Zahnbreite $h_2$	Larg. de denture $h_2$	Ancho diente $h_2$	<b><math>h_2</math></b> -
Largh. dente $h_3$	Tooth width $h_3$	Zahnbreite $h_3$	Larg. de denture $h_3$	Ancho diente $h_3$	<b><math>h_3</math></b> -
Altezza totale H	Full height H	Gesamt Höhe H	Hauteur totale H	Altura total H	<b>H</b> -

**A partire da Z = 51 il disco ruota viene maggiorato, H = 4 mm**

**From Z = 51 the width of the plate is increased, H = 4 mm**

**Ab Zähnezahl Z = 51 beträgt die Scheibendicke H = 4 mm**

**A partir de Z = 51 l'épaisseur du disque est augmenté H = 4 mm**

**A partir de Z = 51 el disco rueda para cadena queda aumentado, H = 4 mm**

Z	De	Dp	CS		Z	De	Dp	CS		Z	De	Dp	CS	
			cod.	D				cod.	D				cod.	D
8	19,4	16,58	CS 03008	6	32	67,6	64,78	CS 03032	10	56	116,0	113,25	CS 03056	12
9	21,4	18,56	CS 03009	6	33	69,6	66,80	CS 03033	10	57	118,1	115,27	CS 03057	12
10	23,3	20,55	CS 03010	6	34	71,6	68,82	CS 03034	10	58	120,1	117,29	CS 03058	12
11	25,3	22,54	CS 03011	8	35	73,6	70,84	CS 03035	10	59	122,1	119,31	CS 03059	12
12	27,3	24,53	CS 03012	8	36	75,6	72,85	CS 03036	10	60	124,1	121,32	CS 03060	12
13	29,3	26,53	CS 03013	8	37	77,7	74,87	CS 03037	10	62	128,2	125,37	CS 03062	12
14	31,3	28,53	CS 03014	8	38	79,7	76,89	CS 03038	10	64	132,2	129,41	CS 03064	12
15	33,3	30,55	CS 03015	8	39	81,7	78,91	CS 03039	10	65	134,2	131,43	CS 03065	12
16	35,3	32,55	CS 03016	8	40	83,7	80,93	CS 03040	10	66	136,2	133,45	CS 03066	14
17	37,3	34,55	CS 03017	8	41	85,7	82,95	CS 03041	10	68	140,3	137,49	CS 03068	14
18	39,4	36,56	CS 03018	8	42	87,8	84,97	CS 03042	10	70	144,3	141,53	CS 03070	14
19	41,4	38,58	CS 03019	8	43	89,8	86,98	CS 03043	10	72	148,4	145,58	CS 03072	14
20	43,4	40,58	CS 03020	8	44	91,8	89,01	CS 03044	10	75	154,4	151,63	CS 03075	14
21	45,4	42,60	CS 03021	8	45	93,8	91,03	CS 03045	10	76	156,5	153,66	CS 03076	14
22	47,4	44,62	CS 03022	8	46	95,8	93,05	CS 03046	10	78	160,5	157,70	CS 03078	16
23	49,4	46,63	CS 03023	8	47	97,9	95,07	CS 03047	10	80	164,5	161,74	CS 03080	16
24	51,4	48,64	CS 03024	8	48	99,9	97,09	CS 03048	10	85	174,6	171,85	CS 03085	16
25	53,3	50,66	CS 03025	8	49	101,9	99,10	CS 03049	10	90	184,7	181,95	CS 03090	16
26	55,5	52,67	CS 03026	8	50	103,9	101,13	CS 03050	10	95	194,8	192,05	CS 03095	16
27	57,5	54,69	CS 03027	8	51	105,9	103,14	CS 03051	12	100	204,9	202,15	CS 03100	16
28	59,5	56,71	CS 03028	8	52	108,0	105,16	CS 03052	12	110	225,1	222,37	CS 03110	16
29	61,5	58,73	CS 03029	8	53	110,0	107,18	CS 03053	12	114	233,2	230,45	CS 03114	16
30	63,6	60,75	CS 03030	8	54	112,0	109,18	CS 03054	12	120	245,4	242,58	CS 03120	16
31	65,6	62,76	CS 03031	10	55	114,0	111,23	CS 03055	12	125	255,5	252,68	CS 03125	16

Corone per catene semplici, a rulli secondo:

DIN 8187 - ISO/R 606

**Corone tornite sui lati, dentate con creatore.**

Plate wheels for simplex chain to:

DIN 8187 - ISO/R 606

**Plate Wheels turned on both sides and toothed by milling cutter.**

Kettenradscheiben für Simplex-Rollenkette nach:

DIN 8187 - ISO/R 606

**Seitlich plan gedrehte, wälzgefräste Zahnkränze.**

Disques pour chaînes simples à rouleaux suivant les normes:

DIN 8187 - ISO/R 606

**Disques tournés sur les flancs, dentés à la fraise.**

Discos para cadena simple de rodillos según:

DIN 8187 - ISO/R 606

**Discos torneadas en los lados, dientes obtenidos con fresa madre.**

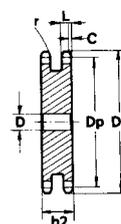
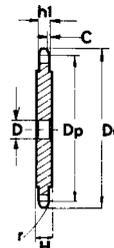

**8 x 3,0 mm**

**05B-1-2**

CATENA:	CHAIN:	KETTE:	CHAÎNE:	CADENA:	ISO mm
Passo	Pitch	Teilung	Pas	Paso	<b>8,0</b>
Larghezza interna	Internal width	Innere Breite	Largeur interieure	Ancho interno	<b>3,0</b>
Rullo $\varnothing$	Roller $\varnothing$	Rollen $\varnothing$	$\varnothing$ du rouleau	Rodillo $\varnothing$	<b>5,0</b>

CORONE	PLATE WHEELS	KETTENRADSCHIEBEN	DISQUES	DISCOS	ISO mm
Raggio dente r	Tooth radius r	Radius r	Rayon de denture r	Radio diente r	<b>r 8,0</b>
Larghezza raggio C	Radius width C	Breite C	Largeur de rayon C	Ancho radio C	<b>C 1,0</b>
Largh. dente $h_1$	Tooth width $h_1$	Zahnbreite $h_1$	Larg. de denture $h_1$	Ancho diente $h_1$	<b><math>h_1</math> 2,8</b>
Largh. dente L	Tooth width L	Zahnbreite L	Larg. de denture L	Ancho diente L	<b>L 2,7</b>
Largh. dente $h_2$	Tooth width $h_2$	Zahnbreite $h_2$	Larg. de denture $h_2$	Ancho diente $h_2$	<b><math>h_2</math> 8,3</b>
Largh. dente $h_3$	Tooth width $h_3$	Zahnbreite $h_3$	Larg. de denture $h_3$	Ancho diente $h_3$	<b><math>h_3</math> -</b>
Altezza totale H	Full height H	Gesamt Höhe H	Hauteur totale H	Altura total H	<b>H -</b>

**A partire da Z = 51 il disco ruota viene maggiorato, H = 4 mm**

**From Z = 51 the width of the plate is increased, H = 4 mm**

**Ab Zähnezahl Z = 51 beträgt die Scheibendicke H = 4 mm**

**A partir de Z = 51 l'épaisseur du disque est augmenté H = 4 mm**

**A partir de Z = 51 el disco rueda para cadena queda aumentado, H = 4 mm**

Z	D <sub>e</sub>	D <sub>p</sub>	CS		CD		Z	D <sub>e</sub>	D <sub>p</sub>	CS		CD	
			cod.	D	cod.	D				cod.	D	cod.	D
8	24,0	20,90	CS 04008	6	CD 04008	6	44	115,5	112,14	CS 04044	12	CD 04044	14
9	26,6	23,39	CS 04009	6	CD 04009	6	45	118,0	114,69	CS 04045	12	CD 04045	14
10	29,2	25,89	CS 04010	8	CD 04010	8	46	120,6	117,23	CS 04046	12	CD 04046	14
11	31,7	28,39	CS 04011	8	CD 04011	8	47	123,1	119,77	CS 04047	12	CD 04047	14
12	34,2	30,91	CS 04012	8	CD 04012	8	48	125,6	122,32	CS 04048	12	CD 04048	14
13	36,7	33,42	CS 04013	8	CD 04013	8	49	128,2	124,86	CS 04049	12	CD 04049	14
14	39,2	35,95	CS 04014	8	CD 04014	8	50	130,7	127,41	CS 04050	12	CD 04050	14
15	41,7	38,48	CS 04015	8	CD 04015	8	51	133,3	129,95	CS 04051	14	CD 04051	16
16	44,3	41,01	CS 04016	8	CD 04016	10	52	135,8	132,49	CS 04052	14	CD 04052	16
17	46,8	43,53	CS 04017	8	CD 04017	10	53	138,4	135,04	CS 04053	14	CD 04053	16
18	49,3	46,07	CS 04018	8	CD 04018	10	54	140,9	137,59	CS 04054	14	CD 04054	16
19	51,9	48,61	CS 04019	8	CD 04019	10	55	143,5	140,13	CS 04055	14	CD 04055	16
20	54,4	51,14	CS 04020	8	CD 04020	10	56	146,0	142,68	CS 04056	14	CD 04056	16
21	57,0	53,67	CS 04021	8	CD 04021	10	57	148,6	145,22	CS 04057	14	CD 04057	16
22	59,5	56,21	CS 04022	8	CD 04022	10	58	151,0	147,77	CS 04058	14	CD 04058	16
23	62,0	58,75	CS 04023	8	CD 04023	10	59	153,6	150,31	CS 04059	14	CD 04059	16
24	64,6	61,29	CS 04024	8	CD 04024	10	60	156,2	152,85	CS 04060	14	CD 04060	16
25	67,5	63,83	CS 04025	8	CD 04025	10	62	162,0	157,95	CS 04062	16	CD 04062	20
26	69,5	66,37	CS 04026	10	CD 04026	12	64	167,1	163,04	CS 04064	16	CD 04064	20
27	72,2	68,91	CS 04027	10	CD 04027	12	65	169,2	165,58	CS 04065	16	CD 04065	20
28	74,8	71,45	CS 04028	10	CD 04028	12	66	172,2	168,13	CS 04066	16	CD 04066	20
29	77,3	73,99	CS 04029	10	CD 04029	12	68	177,3	173,22	CS 04068	16	CD 04068	20
30	79,8	76,53	CS 04030	10	CD 04030	12	70	182,4	178,31	CS 04070	16	CD 04070	20
31	82,4	79,08	CS 04031	10	CD 04031	12	72	187,5	183,41	CS 04072	20	CD 04072	20
32	84,9	81,61	CS 04032	10	CD 04032	12	75	195,1	191,04	CS 04075	20	CD 04075	20
33	87,5	84,16	CS 04033	10	CD 04033	12	76	197,7	193,59	CS 04076	20	CD 04076	20
34	90,0	86,70	CS 04034	10	CD 04034	12	78	202,8	198,68	CS 04078	20	CD 04078	20
35	92,5	89,24	CS 04035	10	CD 04035	12	80	207,9	203,77	CS 04080	20	CD 04080	20
36	95,0	91,79	CS 04036	10	CD 04036	12	85	220,6	216,50	CS 04085	20	CD 04085	20
37	97,6	94,33	CS 04037	10	CD 04037	12	90	233,4	229,23	CS 04090	20	CD 04090	20
38	100,2	96,88	CS 04038	10	CD 04038	12	95	246,1	241,96	CS 04095	20	CD 04095	20
39	102,7	99,42	CS 04039	10	CD 04039	12	100	258,9	254,68	CS 04100	20	CD 04100	20
40	105,2	101,97	CS 04040	10	CD 04040	12	110	284,3	280,15	CS 04110	20	CD 04110	20
41	107,8	104,51	CS 04041	12	CD 04041	14	114	294,5	290,33	CS 04114	20	CD 04114	20
42	110,4	107,05	CS 04042	12	CD 04042	14	120	310,0	305,61	CS 04120	20	CD 04120	20
43	112,9	109,60	CS 04043	12	CD 04043	14	125	322,5	318,34	CS 04125	20	CD 04125	20

Corone per catene semplici, doppie e triple a rulli secondo: DIN 8187 - ISO/R 606

**Corone tornite sui lati, dentate con creatore.**

Plate wheels for simplex duplex and triplex chain to: DIN 8187 - ISO/R 606

**Plate Wheels turned on both sides and toothed by milling cutter.**

Kettenradscheiben für Simplex-Duplex-Triplex-Rollenkette nach: DIN 8187 - ISO/R 606

**Seitlich plan gedrehte, wälzgefräste Zahnkränze.**

Disques pour chaînes simples, doubles et triples à rouleaux suivant les normes: DIN 8187 - ISO/R 606

**Disques tournés sur les flancs, dentés à la fraise.**

Discos para cadena simple, doble y triple de rodillos según: DIN 8187 - ISO/R 606

**Discos torneadas en los lados, dientes obtenidos con fresa madre.**

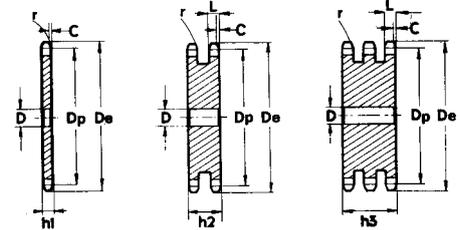
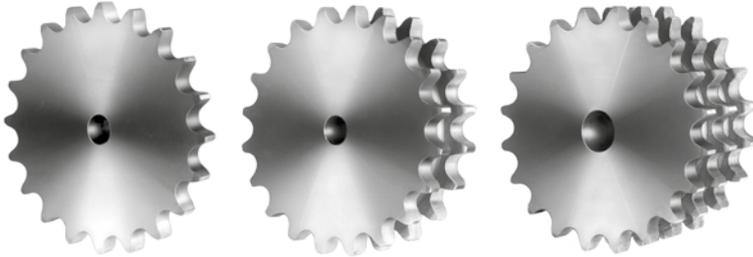

**3/8" x 7/32"**

**06B - 1-2-3 9,525 x 5,72 mm**

CATENA:	CHAIN:	KETTE:	CHAÎNE:	CADENA:	ISO mm
Passo	Pitch	Teilung	Pas	Paso	<b>9,525</b>
Larghezza interna	Internal width	Innere Breite	Largeur interieure	Ancho interno	<b>5,720</b>
Rullo ø	Roller ø	Rollen ø	ø du rouleau	Rodillo ø	<b>6,350</b>

CORONE	PLATE WHEELS	KETTENRADSCHIEBEN	DISQUES	DISCOS	ISO mm
Raggio dente r	Tooth radius r	Radius r	Rayon de denture r	Radio diente r	<b>r 10,0</b>
Larghezza raggio C	Radius width C	Breite C	Largeur de rayon C	Ancho radio C	<b>C 1,0</b>
Largh. dente h <sub>1</sub>	Tooth width h <sub>1</sub>	Zahnbreite h <sub>1</sub>	Larg. de denture h <sub>1</sub>	Ancho diente h <sub>1</sub>	<b>h<sub>1</sub> 5,3</b>
Largh. dente L	Tooth width L	Zahnbreite L	Larg. de denture L	Ancho diente L	<b>L 5,2</b>
Largh. dente h <sub>2</sub>	Tooth width h <sub>2</sub>	Zahnbreite h <sub>2</sub>	Larg. de denture h <sub>2</sub>	Ancho diente h <sub>2</sub>	<b>h<sub>2</sub> 15,4</b>
Largh. dente h <sub>3</sub>	Tooth width h <sub>3</sub>	Zahnbreite h <sub>3</sub>	Larg. de denture h <sub>3</sub>	Ancho diente h <sub>3</sub>	<b>h<sub>3</sub> 25,6</b>
Altezza totale H	Full height H	Gesamt Höhe H	Hauteur totale H	Altura total H	<b>H -</b>

**A partire da Z = 100 il disco ruota viene maggiorato, H = 7 mm**

**From Z = 100 the width of the plate is increased, H = 7 mm**

**Ab Zähnezahl Z = 100 beträgt die Scheibendicke H = 7 mm**

**A partir de Z = 100 l'épaisseur du disque est augmenté H = 7 mm**

**A partir de Z = 100 el disco rueda para cadena queda aumentado, H = 7 mm**

Z	D <sub>e</sub>	D <sub>p</sub>	CS		CD		CT		Z	D <sub>e</sub>	D <sub>p</sub>	CS		CD		CT	
			cod.	D	cod.	D	cod.	D				cod.	D	cod.	D	cod.	D
8	28,0	24,89	CS 05008	6	CD 05008	6	CT 05008	6	44	137,6	133,52	CS 05044	16	CD 05044	16	CT 05044	16
9	31,0	27,85	CS 05009	7	CD 05009	8	CT 05009	8	45	140,7	136,54	CS 05045	16	CD 05045	16	CT 05045	16
10	34,0	30,82	CS 05010	7	CD 05010	8	CT 05010	10	46	143,7	139,58	CS 05046	16	CD 05046	16	CT 05046	16
11	37,0	33,80	CS 05011	8	CD 05011	10	CT 05011	10	47	146,7	142,61	CS 05047	16	CD 05047	16	CT 05047	16
12	40,0	36,80	CS 05012	8	CD 05012	10	CT 05012	10	48	149,7	145,64	CS 05048	16	CD 05048	16	CT 05048	16
13	43,0	39,80	CS 05013	8	CD 05013	10	CT 05013	10	49	152,7	148,66	CS 05049	16	CD 05049	16	CT 05049	16
14	46,3	42,80	CS 05014	8	CD 05014	10	CT 05014	12	50	155,7	151,69	CS 05050	16	CD 05050	16	CT 05050	16
15	49,3	45,81	CS 05015	8	CD 05015	10	CT 05015	12	51	158,7	154,72	CS 05051	16	CD 05051	16	CT 05051	20
16	52,3	48,82	CS 05016	10	CD 05016	12	CT 05016	12	52	161,8	157,75	CS 05052	16	CD 05052	16	CT 05052	20
17	55,3	51,83	CS 05017	10	CD 05017	12	CT 05017	12	53	164,8	160,78	CS 05053	16	CD 05053	16	CT 05053	20
18	58,3	54,85	CS 05018	10	CD 05018	12	CT 05018	12	54	167,8	163,82	CS 05054	16	CD 05054	16	CT 05054	20
19	61,3	57,87	CS 05019	10	CD 05019	12	CT 05019	12	55	170,8	166,85	CS 05055	16	CD 05055	16	CT 05055	20
20	64,3	60,89	CS 05020	10	CD 05020	12	CT 05020	12	56	173,8	169,88	CS 05056	16	CD 05056	16	CT 05056	20
21	68,0	63,91	CS 05021	10	CD 05021	12	CT 05021	14	57	176,9	172,91	CS 05057	16	CD 05057	16	CT 05057	20
22	71,0	66,93	CS 05022	10	CD 05022	12	CT 05022	14	58	179,9	175,93	CS 05058	16	CD 05058	16	CT 05058	20
23	73,5	69,95	CS 05023	10	CD 05023	12	CT 05023	14	59	183,0	178,96	CS 05059	16	CD 05059	16	CT 05059	20
24	77,0	72,97	CS 05024	10	CD 05024	12	CT 05024	14	60	186,0	181,99	CS 05060	16	CD 05060	16	CT 05060	20
25	80,0	76,00	CS 05025	10	CD 05025	12	CT 05025	14	62	192,1	188,06	CS 05062	20	CD 05062	20	CT 05062	20
26	83,0	79,02	CS 05026	10	CD 05026	12	CT 05026	14	64	198,2	194,12	CS 05064	20	CD 05064	20	CT 05064	20
27	86,0	82,04	CS 05027	10	CD 05027	12	CT 05027	14	65	201,6	197,15	CS 05065	20	CD 05065	20	CT 05065	20
28	89,0	85,07	CS 05028	10	CD 05028	12	CT 05028	14	66	204,6	200,18	CS 05066	20	CD 05066	20	CT 05066	25
29	92,0	88,09	CS 05029	10	CD 05029	12	CT 05029	14	68	210,7	206,24	CS 05068	20	CD 05068	20	CT 05068	25
30	94,7	91,12	CS 05030	10	CD 05030	12	CT 05030	14	70	216,7	212,30	CS 05070	20	CD 05070	20	CT 05070	25
31	98,3	94,15	CS 05031	12	CD 05031	14	CT 05031	16	72	222,8	218,37	CS 05072	20	CD 05072	20	CT 05072	25
32	101,3	97,17	CS 05032	12	CD 05032	14	CT 05032	16	75	231,9	227,46	CS 05075	20	CD 05075	20	CT 05075	25
33	104,3	100,20	CS 05033	12	CD 05033	14	CT 05033	16	76	234,9	230,49	CS 05076	20	CD 05076	20	CT 05076	25
34	107,3	103,23	CS 05034	12	CD 05034	14	CT 05034	16	78	241,0	236,55	CS 05078	20	CD 05078	20	CT 05078	25
35	110,4	106,26	CS 05035	12	CD 05035	14	CT 05035	16	80	247,1	242,61	CS 05080	20	CD 05080	20	CT 05080	25
36	113,4	109,29	CS 05036	12	CD 05036	14	CT 05036	16	85	262,2	257,77	CS 05085	20	CD 05085	20	CT 05085	25
37	116,4	112,32	CS 05037	12	CD 05037	14	CT 05037	16	90	277,4	272,93	CS 05090	20	CD 05090	20	CT 05090	25
38	119,5	115,34	CS 05038	12	CD 05038	14	CT 05038	16	95	292,5	288,08	CS 05095	20	CD 05095	20	CT 05095	25
39	122,5	118,37	CS 05039	12	CD 05039	14	CT 05039	16	100	307,7	303,25	CS 05100	20	CD 05100	20	CT 05100	25
40	125,5	121,40	CS 05040	12	CD 05040	14	CT 05040	16	110	338,0	333,55	CS 05110	20	CD 05110	20	CT 05110	25
41	128,5	124,43	CS 05041	16	CD 05041	16	CT 05041	16	114	349,5	345,68	CS 05114	20	CD 05114	20	CT 05114	25
42	131,6	127,46	CS 05042	16	CD 05042	16	CT 05042	16	120	368,3	363,86	CS 05120	20	CD 05120	20	CT 05120	25
43	134,6	130,49	CS 05043	16	CD 05043	16	CT 05043	16	125	383,5	379,02	CS 05125	20	CD 05125	20	CT 05125	25

Corone per catene semplici, a rulli secondo:  
DIN 8187 - ISO/R 606

**Corone tornite sui lati, dentate con creatore.**

Plate wheels for simplex chain to:  
DIN 8187 - ISO/R 606

**Plate Wheels turned on both sides and toothed by milling cutter.**

Kettenradscheiben für Simplex-Rollenkette nach:  
DIN 8187 - ISO/R 606

**Seitlich plan gedrehte, wälzgefästrte Zahnkränze.**

Disques pour chaînes simples à rouleaux suivant les normes:  
DIN 8187 - ISO/R 606

**Disques tournés sur les flancs, dentés à la fraise.**

Discos para cadena simple de rodillos según:  
DIN 8187 - ISO/R 606

**Discos torneadas en los lados, dientes obtenidos con fresa madre.**

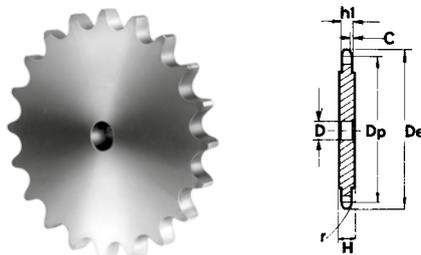

**1/2" x 1/8"**

**081- 1 12,7 x 3,33 mm**

CATENA:	CHAIN:	KETTE:	CHAÎNE:	CADENA:	ISO mm
Passo	Pitch	Teilung	Pas	Paso	<b>12,70</b>
Larghezza interna	Internal width	Innere Breite	Largeur interieure	Ancho interno	<b>3,30</b>
Rullo ø	Roller ø	Rollen ø	ø du rouleau	Rodillo ø	<b>7,75</b>

CORONE	PLATE WHEELS	KETTENRADSCHIEBEN	DISQUES	DISCOS	ISO mm
Raggio dente r	Tooth radius r	Radius r	Rayon de denture r	Radio diente r	<b>r 13,0</b>
Larghezza raggio C	Radius width C	Breite C	Largeur de rayon C	Ancho radio C	<b>C 1,3</b>
Largh. dente h <sub>1</sub>	Tooth width h <sub>1</sub>	Zahnbreite h <sub>1</sub>	Larg. de denture h <sub>1</sub>	Ancho diente h <sub>1</sub>	<b>h<sub>1</sub> 3,0</b>
Largh. dente L	Tooth width L	Zahnbreite L	Larg. de denture L	Ancho diente L	<b>L -</b>
Largh. dente h <sub>2</sub>	Tooth width h <sub>2</sub>	Zahnbreite h <sub>2</sub>	Larg. de denture h <sub>2</sub>	Ancho diente h <sub>2</sub>	<b>h<sub>2</sub> -</b>
Largh. dente h <sub>3</sub>	Tooth width h <sub>3</sub>	Zahnbreite h <sub>3</sub>	Larg. de denture h <sub>3</sub>	Ancho diente h <sub>3</sub>	<b>h<sub>3</sub> -</b>
Altezza totale H	Full height H	Gesamt Höhe H	Hauteur totale H	Altura total H	<b>H -</b>

**A partire da Z = 31 il disco ruota viene maggiorato, H = 4 mm**

**From Z = 31 the width of the plate is increased, H = 4 mm**

**Ab Zähnezahl Z = 31 beträgt die Scheibendicke H = 4 mm**

**A partir de Z = 31 l'épaisseur du disque est augmenté H = 4 mm**

**A partir de Z = 31 el disco rueda para cadena queda aumentado, H = 4 mm**

**A partire da Z = 90 il disco ruota viene maggiorato, H = 6 mm**

**From Z = 90 the width of the plate is increased, H = 6 mm**

**Ab Zähnezahl Z = 90 beträgt die Scheibendicke H = 6 mm**

**A partir de Z = 90 l'épaisseur du disque est augmenté H = 6 mm**

**A partir de Z = 90 el disco rueda para cadena queda aumentado, H = 6 mm**

Z	D <sub>e</sub>	D <sub>p</sub>	CS		Z	D <sub>e</sub>	D <sub>p</sub>	CS		Z	D <sub>e</sub>	D <sub>p</sub>	CS	
			cod.	D				cod.	D				cod.	D
8	37,2	33,18	CS 06008	8	32	135,5	129,56	CS 06032	12	56	232,1	226,50	CS 06056	20
9	41,5	37,13	CS 06009	8	33	139,6	133,60	CS 06033	12	57	236,1	230,54	CS 06057	20
10	46,2	41,10	CS 06010	8	34	143,6	137,64	CS 06034	12	58	240,2	234,58	CS 06058	20
11	49,6	45,07	CS 06011	8	35	147,6	141,68	CS 06035	12	59	244,2	238,62	CS 06059	20
12	53,9	49,07	CS 06012	8	36	151,7	145,72	CS 06036	16	60	248,2	242,66	CS 06060	20
13	58,4	53,06	CS 06013	8	37	155,7	149,76	CS 06037	16	62	256,7	250,75	CS 06062	20
14	62,8	57,07	CS 06014	8	38	159,8	153,80	CS 06038	16	64	264,8	258,82	CS 06064	20
15	66,8	61,09	CS 06015	8	39	163,8	157,83	CS 06039	16	65	268,8	262,86	CS 06065	20
16	70,9	65,10	CS 06016	10	40	167,8	161,87	CS 06040	16	66	272,9	266,90	CS 06066	25
17	74,9	69,11	CS 06017	10	41	171,4	165,91	CS 06041	16	68	280,9	274,99	CS 06068	25
18	78,9	73,14	CS 06018	10	42	175,4	169,95	CS 06042	16	70	289,0	283,07	CS 06070	25
19	82,9	77,16	CS 06019	10	43	179,5	173,99	CS 06043	16	72	297,1	291,16	CS 06072	25
20	86,9	81,19	CS 06020	10	44	183,5	178,03	CS 06044	16	76	313,3	307,33	CS 06076	25
21	91,0	85,22	CS 06021	10	45	187,5	182,07	CS 06045	16	78	321,4	315,40	CS 06078	25
22	95,0	89,24	CS 06022	10	46	191,6	186,10	CS 06046	20	80	329,4	323,48	CS 06080	25
23	99,0	93,27	CS 06023	10	47	195,6	190,14	CS 06047	20	85	349,7	343,70	CS 06085	25
24	103,0	97,29	CS 06024	10	48	199,7	194,18	CS 06048	20	90	369,9	363,90	CS 06090	25
25	107,1	101,33	CS 06025	10	49	203,7	198,22	CS 06049	20	100	410,3	404,31	CS 06100	25
26	111,2	105,36	CS 06026	12	50	207,8	202,26	CS 06050	20	110	450,7	444,74	CS 06110	25
27	115,4	109,40	CS 06027	12	51	211,8	206,30	CS 06051	20	114	466,9	460,90	CS 06114	25
28	119,4	113,42	CS 06028	12	52	215,9	210,34	CS 06052	20	120	491,2	485,16	CS 06120	25
29	123,4	117,46	CS 06029	12	53	219,9	214,37	CS 06053	20	125	511,4	505,37	CS 06125	25
30	127,5	121,50	CS 06030	12	54	224,0	218,43	CS 06054	20					
31	131,5	125,54	CS 06031	12	55	228,0	222,46	CS 06055	20					

Corone per catene semplici, a rulli secondo:

DIN 8187 - ISO/R 606

**Corone tornite sui lati, dentate con creatore.**

Plate wheels for simplex chain to:

DIN 8187 - ISO/R 606

**Plate Wheels turned on both sides and toothed by milling cutter.**

Kettenradscheiben für Simplex-Rollenkette nach:

DIN 8187 - ISO/R 606

**Seitlich plan gedrehte, wälzgefräste Zahnkränze.**

Disques pour chaînes simples à rouleaux suivant les normes:

DIN 8187 - ISO/R 606

**Disques tournés sur les flancs, dentés à la fraise.**

Discos para cadena simple de rodillos según:

DIN 8187 - ISO/R 606

**Discos torneadas en los lados, dientes obtenidos con fresa madre.**

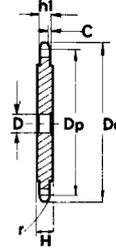

**1/2" x 3/16"**

**083 - 1/084 - 1 12,7 x 4,88 mm**

CATENA:	CHAIN:	KETTE:	CHAÎNE:	CADENA:	ISO mm
Passo	Pitch	Teilung	Pas	Paso	<b>12,70</b>
Larghezza interna	Internal width	Innere Breite	Largeur interieure	Ancho interno	<b>4,88</b>
Rullo $\varnothing$	Roller $\varnothing$	Rollen $\varnothing$	$\varnothing$ du rouleau	Rodillo $\varnothing$	<b>7,75</b>

CORONE	PLATE WHEELS	KETTENRADSCHIEBEN	DISQUES	DISCOS	ISO mm
Raggio dente r	Tooth radius r	Radius r	Rayon de denture r	Radio diente r	<b>r 13,0</b>
Larghezza raggio C	Radius width C	Breite C	Largeur de rayon C	Ancho radio C	<b>C 1,3</b>
Largh. dente $h_1$	Tooth width $h_1$	Zahnbreite $h_1$	Larg. de denture $h_1$	Ancho diente $h_1$	<b><math>h_1</math> 4,5</b>
Largh. dente L	Tooth width L	Zahnbreite L	Larg. de denture L	Ancho diente L	<b>L -</b>
Largh. dente $h_2$	Tooth width $h_2$	Zahnbreite $h_2$	Larg. de denture $h_2$	Ancho diente $h_2$	<b><math>h_2</math> -</b>
Largh. dente $h_3$	Tooth width $h_3$	Zahnbreite $h_3$	Larg. de denture $h_3$	Ancho diente $h_3$	<b><math>h_3</math> -</b>
Altezza totale H	Full height H	Gesamt Höhe H	Hauteur totale H	Altura total H	<b>H -</b>

**A partire da Z = 90 il disco ruota viene maggiorato, H = 6 mm**

**From Z = 90 the width of the plate is increased, H = 6 mm**

**Ab Zähnezahl Z = 90 beträgt die Scheibendicke H = 6 mm**

**A partir de Z = 90 l'épaisseur du disque est augmenté H = 6 mm**

**A partir de Z = 90 el disco ruoda para cadena queda aumentado, H = 6 mm**

Z	D <sub>e</sub>	D <sub>p</sub>	CS		Z	D <sub>e</sub>	D <sub>p</sub>	CS		Z	D <sub>e</sub>	D <sub>p</sub>	CS	
			cod.	D				cod.	D				cod.	D
8	37,2	33,18	CS 06008	8	32	135,5	129,56	CS 06032	12	56	232,1	226,50	CS 06056	20
9	41,5	37,13	CS 06009	8	33	139,6	133,60	CS 06033	12	57	236,1	230,54	CS 06057	20
10	46,2	41,10	CS 06010	8	34	143,6	137,64	CS 06034	12	58	240,2	234,58	CS 06058	20
11	49,6	45,07	CS 06011	8	35	147,6	141,68	CS 06035	12	59	244,2	238,62	CS 06059	20
12	53,9	49,07	CS 06012	8	36	151,7	145,72	CS 06036	16	60	248,2	242,66	CS 06060	20
13	58,4	53,06	CS 06013	8	37	155,7	149,76	CS 06037	16	62	256,7	250,75	CS 06062	20
14	62,8	57,07	CS 06014	8	38	159,8	153,80	CS 06038	16	64	264,8	258,82	CS 06064	20
15	66,8	61,09	CS 06015	8	39	163,8	157,83	CS 06039	16	65	268,8	262,86	CS 06065	20
16	70,9	65,10	CS 06016	10	40	167,8	161,87	CS 06040	16	66	272,9	266,90	CS 06066	25
17	74,9	69,11	CS 06017	10	41	171,4	165,91	CS 06041	16	68	280,9	274,99	CS 06068	25
18	78,9	73,14	CS 06018	10	42	175,4	169,95	CS 06042	16	70	289,0	283,07	CS 06070	25
19	82,9	77,16	CS 06019	10	43	179,5	173,99	CS 06043	16	72	297,1	291,16	CS 06072	25
20	86,9	81,19	CS 06020	10	44	183,5	178,03	CS 06044	16	76	313,3	307,33	CS 06076	25
21	91,0	85,22	CS 06021	10	45	187,5	182,07	CS 06045	16	78	321,4	315,40	CS 06078	25
22	95,0	89,24	CS 06022	10	46	191,6	186,10	CS 06046	20	80	329,4	323,48	CS 06080	25
23	99,0	93,27	CS 06023	10	47	195,6	190,14	CS 06047	20	85	349,7	343,70	CS 06085	25
24	103,0	97,29	CS 06024	10	48	199,7	194,18	CS 06048	20	90	369,9	363,90	CS 06090	25
25	107,1	101,33	CS 06025	10	49	203,7	198,22	CS 06049	20	100	410,3	404,31	CS 06100	25
26	111,2	105,36	CS 06026	12	50	207,8	202,26	CS 06050	20	110	450,7	444,74	CS 06110	25
27	115,4	109,40	CS 06027	12	51	211,8	206,30	CS 06051	20	114	466,9	460,90	CS 06114	25
28	119,4	113,42	CS 06028	12	52	215,9	210,34	CS 06052	20	120	491,2	485,16	CS 06120	25
29	123,4	117,46	CS 06029	12	53	219,9	214,37	CS 06053	20	125	511,4	505,37	CS 06125	25
30	127,5	121,50	CS 06030	12	54	224,0	218,43	CS 06054	20					
31	131,5	125,54	CS 06031	12	55	228,0	222,46	CS 06055	20					



Corone per catene semplici, a rulli secondo:

DIN 8187 - ISO/R 606

**Corone tornite sui lati, dentate con creatore.**

Plate wheels for simplex chain to:

DIN 8187 - ISO/R 606

**Plate Wheels turned on both sides and toothed by milling cutter.**

Kettenradscheiben für Simplex-Rollenkette nach:

DIN 8187 - ISO/R 606

**Seitlich plan gedrehte, wälzgefäzte Zahnkränze.**

Disques pour chaînes simples à rouleaux suivant les normes:

DIN 8187 - ISO/R 606

**Disques tournés sur les flancs, dentés à la fraise.**

Discos para cadena simple de rodillos según:

DIN 8187 - ISO/R 606

**Discos torneadas en los lados, dientes obtenidos con fresa madre.**

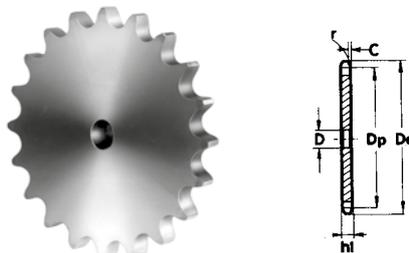

**1/2" x 1/4"**

**085-1 12,7 x 6,4 x 7,75 mm**

CATENA:	CHAIN:	KETTE:	CHAÎNE:	CADENA:	ISO mm
Passo	Pitch	Teilung	Pas	Paso	<b>12,70</b>
Larghezza interna	Internal width	Innere Breite	Largeur interieure	Ancho interno	<b>6,40</b>
Rullo ø	Roller ø	Rollen ø	ø du rouleau	Rodillo ø	<b>7,75</b>

CORONE	PLATE WHEELS	KETTENRADSCHIEBEN	DISQUES	DISCOS	ISO mm
Raggio dente r	Tooth radius r	Radius r	Rayon de denture r	Radio diente r	<b>r 13,0</b>
Larghezza raggio C	Radius width C	Breite C	Largeur de rayon C	Ancho radio C	<b>C 1,3</b>
Largh. dente h <sub>1</sub>	Tooth width h <sub>1</sub>	Zahnbreite h <sub>1</sub>	Larg. de denture h <sub>1</sub>	Ancho diente h <sub>1</sub>	<b>h<sub>1</sub> 5,9</b>
Largh. dente L	Tooth width L	Zahnbreite L	Larg. de denture L	Ancho diente L	<b>L -</b>
Largh. dente h <sub>2</sub>	Tooth width h <sub>2</sub>	Zahnbreite h <sub>2</sub>	Larg. de denture h <sub>2</sub>	Ancho diente h <sub>2</sub>	<b>h<sub>2</sub> -</b>
Largh. dente h <sub>3</sub>	Tooth width h <sub>3</sub>	Zahnbreite h <sub>3</sub>	Larg. de denture h <sub>3</sub>	Ancho diente h <sub>3</sub>	<b>h<sub>3</sub> -</b>
Altezza totale H	Full height H	Gesamt Höhe H	Hauteur totale H	Altura total H	<b>H -</b>

Z	D <sub>e</sub>	D <sub>p</sub>	CS	
			cod.	D
8	38,5	33,18	CS 08008	8
9	41,5	37,13	CS 08009	8
10	46,2	41,10	CS 08010	8
11	49,6	45,07	CS 08011	8
12	53,9	49,07	CS 08012	8
13	58,4	53,06	CS 08013	8
14	62,8	57,07	CS 08014	8
15	66,8	61,09	CS 08015	8
16	70,9	65,10	CS 08016	10
17	74,9	69,11	CS 08017	10
18	78,9	73,14	CS 08018	10
19	82,9	77,16	CS 08019	10
20	86,9	81,19	CS 08020	10
21	91,0	85,22	CS 08021	10
22	95,0	89,24	CS 08022	10
23	99,0	93,27	CS 08023	10
24	103,0	97,29	CS 08024	10
25	107,1	101,33	CS 08025	10
26	111,2	105,36	CS 08026	12
27	115,4	109,40	CS 08027	12
28	119,4	113,42	CS 08028	12
29	123,4	117,46	CS 08029	12
30	127,5	121,50	CS 08030	12
31	131,5	125,54	CS 08031	12

Z	D <sub>e</sub>	D <sub>p</sub>	CS	
			cod.	D
32	135,5	129,56	CS 08032	12
33	139,6	133,60	CS 08033	12
34	143,6	137,64	CS 08034	12
35	147,6	141,68	CS 08035	12
36	151,7	145,72	CS 08036	16
37	155,7	149,76	CS 08037	16
38	159,8	153,80	CS 08038	16
39	163,8	157,83	CS 08039	16
40	167,8	161,87	CS 08040	16
41	171,4	165,91	CS 08041	16
42	175,4	169,95	CS 08042	16
43	179,5	173,99	CS 08043	16
44	183,5	178,03	CS 08044	16
45	187,5	182,07	CS 08045	16
46	191,6	186,10	CS 08046	20
47	195,6	190,14	CS 08047	20
48	199,7	194,18	CS 08048	20
49	203,7	198,22	CS 08049	20
50	207,8	202,26	CS 08050	20
51	211,8	206,30	CS 08051	20
52	215,9	210,34	CS 08052	20
53	219,9	214,37	CS 08053	20
54	224,0	218,43	CS 08054	20
55	228,0	222,46	CS 08055	20

Z	D <sub>e</sub>	D <sub>p</sub>	CS	
			cod.	D
56	232,1	226,50	CS 08056	20
57	236,1	230,54	CS 08057	20
58	240,2	234,58	CS 08058	20
59	244,2	238,62	CS 08059	20
60	248,2	242,66	CS 08060	20
62	256,7	250,75	CS 08062	20
64	264,8	258,82	CS 08064	20
65	268,8	262,86	CS 08065	20
66	272,9	266,90	CS 08066	25
68	280,9	274,99	CS 08068	25
70	289,0	283,07	CS 08070	25
72	297,1	291,16	CS 08072	25
76	313,3	307,33	CS 08076	25
78	321,4	315,40	CS 08078	25
80	329,4	323,48	CS 08080	25
85	349,7	343,70	CS 08085	25
90	369,9	363,90	CS 08090	25
100	410,3	404,31	CS 08100	25
110	450,7	444,74	CS 08110	25
114	466,9	460,90	CS 08114	25
120	491,2	485,16	CS 08120	25
125	511,4	505,37	CS 08125	25

Corone per catene semplici, a rulli secondo:

DIN 8187 - ISO/R 606

**Corone tornite sui lati, dentate con creatore.**

Plate wheels for simplex chain to:

DIN 8187 - ISO/R 606

**Plate Wheels turned on both sides and toothed by milling cutter.**

Kettenradscheiben für Simplex-Rollenkette nach:

DIN 8187 - ISO/R 606

**Seitlich plan gedrehte, wälzgefräste Zahnkränze.**

Disques pour chaînes simples à rouleaux suivant les normes:

DIN 8187 - ISO/R 606

**Disques tournés sur les flancs, dentés à la fraise.**

Discos para cadena simple de rodillos según:

DIN 8187 - ISO/R 606

**Discos torneadas en los lados, dientes obtenidos con fresa madre.**

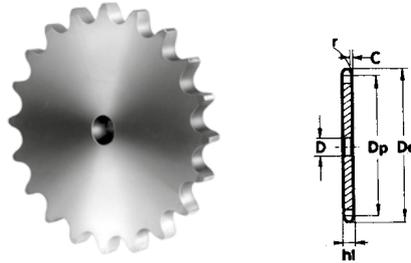

**1/2" x 1/4"**

**085-1 12,7 x 6,4 x 8,51 mm**

CATENA:	CHAIN:	KETTE:	CHAÎNE:	CADENA:	ISO mm
Passo	Pitch	Teilung	Pas	Paso	<b>12,70</b>
Larghezza interna	Internal width	Innere Breite	Largeur interieure	Ancho interno	<b>6,40</b>
Rullo ø	Roller ø	Rollen ø	ø du rouleau	Rodillo ø	<b>8,51</b>

CORONE	PLATE WHEELS	KETTENRADSCHIEBEN	DISQUES	DISCOS	ISO mm
Raggio dente r	Tooth radius r	Radius r	Rayon de denture r	Radio diente r	<b>r 13,0</b>
Larghezza raggio C	Radius width C	Breite C	Largeur de rayon C	Ancho radio C	<b>C 1,3</b>
Largh. dente h <sub>1</sub>	Tooth width h <sub>1</sub>	Zahnbreite h <sub>1</sub>	Larg. de denture h <sub>1</sub>	Ancho diente h <sub>1</sub>	<b>h<sub>1</sub> 5,9</b>
Largh. dente L	Tooth width L	Zahnbreite L	Larg. de denture L	Ancho diente L	<b>L -</b>
Largh. dente h <sub>2</sub>	Tooth width h <sub>2</sub>	Zahnbreite h <sub>2</sub>	Larg. de denture h <sub>2</sub>	Ancho diente h <sub>2</sub>	<b>h<sub>2</sub> -</b>
Largh. dente h <sub>3</sub>	Tooth width h <sub>3</sub>	Zahnbreite h <sub>3</sub>	Larg. de denture h <sub>3</sub>	Ancho diente h <sub>3</sub>	<b>h<sub>3</sub> -</b>
Altezza totale H	Full height H	Gesamt Höhe H	Hauteur totale H	Altura total H	<b>H -</b>

Z	D <sub>e</sub>	D <sub>p</sub>	CS		Z	D <sub>e</sub>	D <sub>p</sub>	CS		Z	D <sub>e</sub>	D <sub>p</sub>	CS	
			cod.	D				cod.	D				cod.	D
8	37,2	33,18	CS 17008	8	32	134,2	129,56	CS 17032	12	56	232,2	226,50	CS 17056	20
9	41,0	37,13	CS 17009	8	33	138,4	133,60	CS 17033	12	57	236,4	230,54	CS 17057	20
10	45,2	41,10	CS 17010	8	34	142,6	137,64	CS 17034	12	58	240,5	234,58	CS 17058	20
11	48,7	45,07	CS 17011	8	35	146,7	141,68	CS 17035	12	59	244,5	238,62	CS 17059	20
12	53,0	49,07	CS 17012	8	36	151,0	145,72	CS 17036	16	60	248,6	242,66	CS 17060	20
13	57,4	53,06	CS 17013	8	37	154,6	149,76	CS 17037	16	62	256,9	250,75	CS 17062	20
14	61,8	57,07	CS 17014	8	38	158,6	153,80	CS 17038	16	64	265,1	258,82	CS 17064	20
15	65,5	61,09	CS 17015	8	39	162,7	157,83	CS 17039	16	65	269,0	262,86	CS 17065	20
16	69,5	65,10	CS 17016	10	40	166,8	161,87	CS 17040	16	66	273,0	266,90	CS 17066	25
17	73,6	69,11	CS 17017	10	41	171,4	165,91	CS 17041	16	68	281,0	274,99	CS 17068	25
18	77,8	73,14	CS 17018	10	42	175,4	169,95	CS 17042	16	70	289,0	283,07	CS 17070	25
19	81,7	77,16	CS 17019	10	43	179,7	173,99	CS 17043	16	72	297,2	291,16	CS 17072	25
20	85,8	81,19	CS 17020	10	44	183,8	178,03	CS 17044	16	76	313,3	307,33	CS 17076	25
21	89,7	85,22	CS 17021	10	45	188,0	182,07	CS 17045	16	78	321,4	315,40	CS 17078	25
22	93,8	89,24	CS 17022	10	46	192,1	186,10	CS 17046	20	80	329,4	323,48	CS 17080	25
23	98,2	93,27	CS 17023	10	47	196,2	190,14	CS 17047	20	85	349,0	343,70	CS 17085	25
24	101,8	97,29	CS 17024	10	48	200,3	194,18	CS 17048	20	90	369,9	363,90	CS 17090	25
25	105,8	101,33	CS 17025	10	49	204,3	198,22	CS 17049	20	100	410,3	404,31	CS 17100	25
26	110,0	105,36	CS 17026	12	50	208,3	202,26	CS 17050	20	110	450,7	444,74	CS 17110	25
27	114,0	109,40	CS 17027	12	51	212,1	206,30	CS 17051	20	114	466,9	460,90	CS 17114	25
28	118,0	113,42	CS 17028	12	52	216,1	210,34	CS 17052	20	120	491,2	485,16	CS 17120	25
29	122,0	117,46	CS 17029	12	53	220,2	214,37	CS 17053	20	125	511,3	505,37	CS 17125	25
30	126,1	121,50	CS 17030	12	54	224,1	218,43	CS 17054	20					
31	130,2	125,54	CS 17031	12	55	228,1	222,46	CS 17055	20					

Corone per catene semplici, doppie e triple a rulli secondo: DIN 8187 - ISO/R 606

**Corone tornite sui lati, dentate con creatore.**

Plate wheels for simplex duplex and triplex chain to: DIN 8187 - ISO/R 606

**Plate Wheels turned on both sides and toothed by milling cutter.**

Kettenradscheiben für Simplex-Duplex-Triplex-Rollenkette nach: DIN 8187 - ISO/R 606

**Seitlich plan gedrehte, wälzgefästrte Zahnkränze.**

Disques pour chaînes simples, doubles et triples à rouleaux suivant les normes: DIN 8187 - ISO/R 606

**Disques tournés sur les flancs, dentés à la fraise.**

Discos para cadena simple, doble y triple de rodillos según: DIN 8187 - ISO/R 606

**Discos torneadas en los lados, dientes obtenidos con fresa madre.**

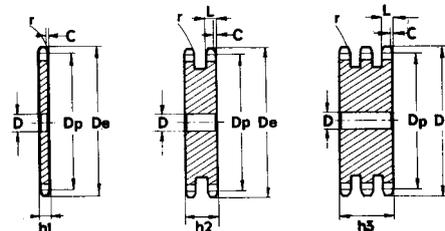
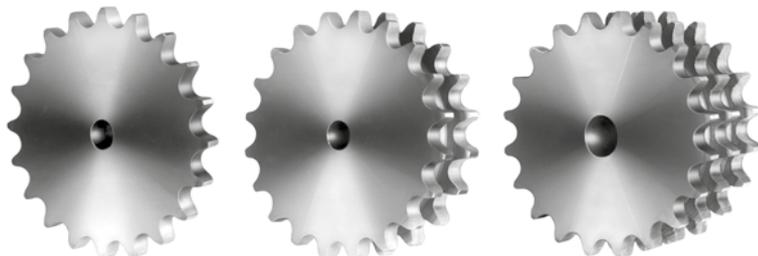

**1/2" x 5/16"**

**08B - 1-2-3 12,7 x 7,75 mm**

CATENA:	CHAIN:	KETTE:	CHAÎNE:	CADENA:	ISO mm
Passo	Pitch	Teilung	Pas	Paso	<b>12,70</b>
Larghezza interna	Internal width	Innere Breite	Largeur interieure	Ancho interno	<b>7,75</b>
Rullo ø	Roller ø	Rollen ø	ø du rouleau	Rodillo ø	<b>8,51</b>

CORONE	PLATE WHEELS	KETTENRADSCHIEBEN	DISQUES	DISCOS	ISO mm
Raggio dente r	Tooth radius r	Radius r	Rayon de denture r	Radio diente r	<b>r 13,0</b>
Larghezza raggio C	Radius width C	Breite C	Largeur de rayon C	Ancho radio C	<b>C 1,3</b>
Largh. dente h <sub>1</sub>	Tooth width h <sub>1</sub>	Zahnbreite h <sub>1</sub>	Larg. de denture h <sub>1</sub>	Ancho diente h <sub>1</sub>	<b>h<sub>1</sub> 7,2</b>
Largh. dente L	Tooth width L	Zahnbreite L	Larg. de denture L	Ancho diente L	<b>L 7,0</b>
Largh. dente h <sub>2</sub>	Tooth width h <sub>2</sub>	Zahnbreite h <sub>2</sub>	Larg. de denture h <sub>2</sub>	Ancho diente h <sub>2</sub>	<b>h<sub>2</sub> 21,0</b>
Largh. dente h <sub>3</sub>	Tooth width h <sub>3</sub>	Zahnbreite h <sub>3</sub>	Larg. de denture h <sub>3</sub>	Ancho diente h <sub>3</sub>	<b>h<sub>3</sub> 34,9</b>
Altezza totale H	Full height H	Gesamt Höhe H	Hauteur totale H	Altura total H	<b>H -</b>

Z	D <sub>e</sub>	D <sub>p</sub>	CS		CD		CT	
			cod.	D	cod.	D	cod.	D
8	37,2	33,18	CS 09008	8	CD 09008	10	CT 09008	10
9	41,0	37,13	CS 09009	8	CD 09009	10	CT 09009	10
10	45,2	41,10	CS 09010	8	CD 09010	10	CT 09010	10
11	48,7	45,07	CS 09011	10	CD 09011	10	CT 09011	12
12	53,0	49,07	CS 09012	10	CD 09012	10	CT 09012	12
13	57,4	53,06	CS 09013	10	CD 09013	10	CT 09013	12
14	61,8	57,07	CS 09014	10	CD 09014	10	CT 09014	12
15	65,5	61,09	CS 09015	10	CD 09015	10	CT 09015	12
16	69,5	65,10	CS 09016	10	CD 09016	12	CT 09016	16
17	73,6	69,11	CS 09017	10	CD 09017	12	CT 09017	16
18	77,8	73,14	CS 09018	10	CD 09018	12	CT 09018	16
19	81,7	77,16	CS 09019	10	CD 09019	12	CT 09019	16
20	85,8	81,19	CS 09020	10	CD 09020	12	CT 09020	16
21	89,7	85,22	CS 09021	12	CD 09021	16	CT 09021	16
22	93,8	89,24	CS 09022	12	CD 09022	16	CT 09022	16
23	98,2	93,27	CS 09023	12	CD 09023	16	CT 09023	16
24	101,8	97,29	CS 09024	12	CD 09024	16	CT 09024	16
25	105,8	101,33	CS 09025	12	CD 09025	16	CT 09025	16
26	110,0	105,36	CS 09026	16	CD 09026	16	CT 09026	16
27	114,0	109,40	CS 09027	16	CD 09027	16	CT 09027	16
28	118,0	113,42	CS 09028	16	CD 09028	16	CT 09028	16
29	122,0	117,46	CS 09029	16	CD 09029	16	CT 09029	16
30	126,1	121,50	CS 09030	16	CD 09030	16	CT 09030	16
31	130,2	125,54	CS 09031	16	CD 09031	16	CT 09031	20
32	134,3	129,56	CS 09032	16	CD 09032	16	CT 09032	20
33	138,4	133,60	CS 09033	16	CD 09033	16	CT 09033	20
34	142,6	137,64	CS 09034	16	CD 09034	16	CT 09034	20
35	146,7	141,68	CS 09035	16	CD 09035	16	CT 09035	20
36	151,0	145,72	CS 09036	16	CD 09036	20	CT 09036	20
37	154,6	149,76	CS 09037	16	CD 09037	20	CT 09037	20
38	158,6	153,80	CS 09038	16	CD 09038	20	CT 09038	20
39	162,7	157,83	CS 09039	16	CD 09039	20	CT 09039	20
40	166,8	161,87	CS 09040	16	CD 09040	20	CT 09040	20
41	171,4	165,91	CS 09041	20	CD 09041	20	CT 09041	25
42	175,4	169,95	CS 09042	20	CD 09042	20	CT 09042	25
43	179,7	173,99	CS 09043	20	CD 09043	20	CT 09043	25

Z	D <sub>e</sub>	D <sub>p</sub>	CS		CD		CT	
			cod.	D	cod.	D	cod.	D
44	183,8	178,03	CS 09044	20	CD 09044	20	CT 09044	25
45	188,0	182,07	CS 09045	20	CD 09045	20	CT 09045	25
46	192,1	186,10	CS 09046	20	CD 09046	20	CT 09046	25
47	196,2	190,14	CS 09047	20	CD 09047	20	CT 09047	25
48	200,3	194,18	CS 09048	20	CD 09048	20	CT 09048	25
49	204,3	198,22	CS 09049	20	CD 09049	20	CT 09049	25
50	208,3	202,26	CS 09050	20	CD 09050	20	CT 09050	25
51	212,1	206,30	CS 09051	20	CD 09051	25	CT 09051	25
52	216,1	210,34	CS 09052	20	CD 09052	25	CT 09052	25
53	220,2	214,37	CS 09053	20	CD 09053	25	CT 09053	25
54	224,1	218,43	CS 09054	20	CD 09054	25	CT 09054	25
55	228,1	222,46	CS 09055	20	CD 09055	25	CT 09055	25
56	232,2	226,50	CS 09056	20	CD 09056	25	CT 09056	25
57	236,4	230,54	CS 09057	20	CD 09057	25	CT 09057	25
58	240,5	234,58	CS 09058	20	CD 09058	25	CT 09058	25
59	244,5	238,62	CS 09059	20	CD 09059	25	CT 09059	25
60	248,6	242,66	CS 09060	20	CD 09060	25	CT 09060	25
62	256,9	250,75	CS 09062	25	CD 09062	25	CT 09062	25
64	265,1	258,82	CS 09064	25	CD 09064	25	CT 09064	25
65	269,0	262,86	CS 09065	25	CD 09065	25	CT 09065	25
66	273,0	266,90	CS 09066	25	CD 09066	25	CT 09066	25
68	281,0	274,99	CS 09068	25	CD 09068	25	CT 09068	25
70	289,0	283,07	CS 09070	25	CD 09070	25	CT 09070	25
72	297,2	291,16	CS 09072	25	CD 09072	25	CT 09072	25
75	309,2	303,27	CS 09075	25	CD 09075	25	CT 09075	25
76	313,3	307,33	CS 09076	25	CD 09076	25	CT 09076	25
78	321,4	315,40	CS 09078	25	CD 09078	25	CT 09078	25
80	329,4	323,48	CS 09080	25	CD 09080	25	CT 09080	25
85	349,0	343,69	CS 09085	25	CD 09085	25	CT 09085	25
90	369,9	363,90	CS 09090	25	CD 09090	25	CT 09090	25
95	390,1	384,11	CS 09095	25	CD 09095	25	CT 09095	25
100	410,3	404,31	CS 09100	25	CD 09100	25	CT 09100	25
110	450,7	444,74	CS 09110	25	CD 09110	25	CT 09110	25
114	466,9	460,90	CS 09114	25	CD 09114	25	CT 09114	25
120	491,2	485,16	CS 09120	25	CD 09120	25	CT 09120	25
125	511,3	505,37	CS 09125	25	CD 09125	25	CT 09125	25

Corone per catene semplici, doppie e triple a rulli secondo: DIN 8187 - ISO/R 606

**Corone tornite sui lati, dentate con creatore.**

Plate wheels for simplex duplex and triplex chain to: DIN 8187 - ISO/R 606

**Plate Wheels turned on both sides and toothed by milling cutter.**

Kettenradscheiben für Simplex-Duplex-Triplex-Rollenkette nach: DIN 8187 - ISO/R 606

**Seitlich plan gedrehte, wälzgefräste Zahnkränze.**

Disques pour chaînes simples, doubles et triples à rouleaux suivant les normes: DIN 8187 - ISO/R 606

**Disques tournés sur les flancs, dentés à la fraise.**

Discos para cadena simple, doble y triple de rodillos según: DIN 8187 - ISO/R 606

**Discos torneadas en los lados, dientes obtenidos con fresa madre.**

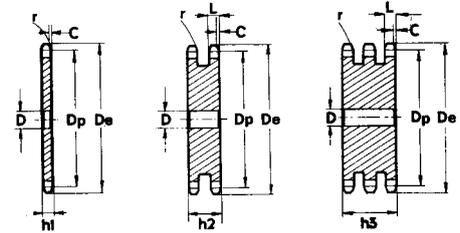
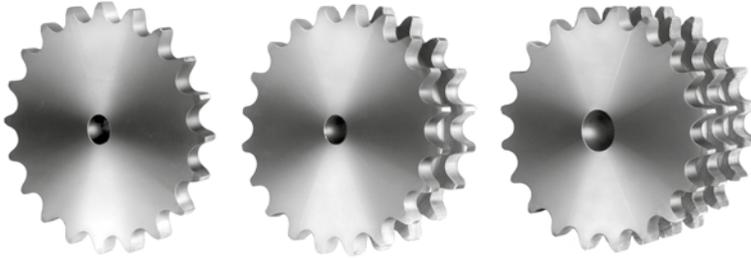

**5/8" x 3/8"**

**10B - 1-2-3 15,875 x 9,65 mm**

CATENA:	CHAIN:	KETTE:	CHAÎNE:	CADENA:	ISO mm
Passo	Pitch	Teilung	Pas	Paso	<b>15,875</b>
Larghezza interna	Internal width	Innere Breite	Largeur interieure	Ancho interno	<b>9,650</b>
Rullo ø	Roller ø	Rollen ø	ø du rouleau	Rodillo ø	<b>10,160</b>

CORONE	PLATE WHEELS	KETTENRADSCHIEBEN	DISQUES	DISCOS	ISO mm
Raggio dente r	Tooth radius r	Radius r	Rayon de denture r	Radio diente r	<b>r 16,0</b>
Larghezza raggio C	Radius width C	Breite C	Largeur de rayon C	Ancho radio C	<b>C 1,6</b>
Largh. dente h <sub>1</sub>	Tooth width h <sub>1</sub>	Zahnbreite h <sub>1</sub>	Larg. de denture h <sub>1</sub>	Ancho diente h <sub>1</sub>	<b>h<sub>1</sub> 9,1</b>
Largh. dente L	Tooth width L	Zahnbreite L	Larg. de denture L	Ancho diente L	<b>L 9,0</b>
Largh. dente h <sub>2</sub>	Tooth width h <sub>2</sub>	Zahnbreite h <sub>2</sub>	Larg. de denture h <sub>2</sub>	Ancho diente h <sub>2</sub>	<b>h<sub>2</sub> 25,5</b>
Largh. dente h <sub>3</sub>	Tooth width h <sub>3</sub>	Zahnbreite h <sub>3</sub>	Larg. de denture h <sub>3</sub>	Ancho diente h <sub>3</sub>	<b>h<sub>3</sub> 42,1</b>
Altezza totale H	Full height H	Gesamt Höhe H	Hauteur totale H	Altura total H	<b>H -</b>

Z	D <sub>e</sub>	D <sub>p</sub>	CS		CD		CT	
			cod.	D	cod.	D	cod.	D
8	47,0	41,48	CS 10008	10	CD 10008	10	CT 10008	12
9	52,6	46,42	CS 10009	10	CD 10009	10	CT 10009	12
10	57,5	51,37	CS 10010	10	CD 10010	10	CT 10010	12
11	63,0	56,34	CS 10011	10	CD 10011	12	CT 10011	12
12	68,0	61,34	CS 10012	10	CD 10012	12	CT 10012	12
13	73,0	66,32	CS 10013	10	CD 10013	12	CT 10013	12
14	78,0	71,34	CS 10014	10	CD 10014	12	CT 10014	12
15	83,0	76,36	CS 10015	10	CD 10015	12	CT 10015	12
16	88,0	81,37	CS 10016	12	CD 10016	12	CT 10016	16
17	93,0	86,39	CS 10017	12	CD 10017	12	CT 10017	16
18	98,3	91,42	CS 10018	12	CD 10018	12	CT 10018	16
19	103,3	96,45	CS 10019	12	CD 10019	12	CT 10019	16
20	108,4	101,49	CS 10020	12	CD 10020	12	CT 10020	16
21	113,4	106,52	CS 10021	12	CD 10021	16	CT 10021	16
22	118,0	111,55	CS 10022	12	CD 10022	16	CT 10022	16
23	123,4	116,58	CS 10023	12	CD 10023	16	CT 10023	16
24	128,3	121,62	CS 10024	12	CD 10024	16	CT 10024	16
25	134,0	126,66	CS 10025	12	CD 10025	16	CT 10025	16
26	139,0	131,70	CS 10026	16	CD 10026	16	CT 10026	20
27	144,0	136,75	CS 10027	16	CD 10027	16	CT 10027	20
28	148,7	141,78	CS 10028	16	CD 10028	16	CT 10028	20
29	153,8	146,83	CS 10029	16	CD 10029	16	CT 10029	20
30	158,8	151,87	CS 10030	16	CD 10030	16	CT 10030	20
31	163,9	156,92	CS 10031	16	CD 10031	20	CT 10031	20
32	168,9	161,95	CS 10032	16	CD 10032	20	CT 10032	20
33	174,5	167,00	CS 10033	16	CD 10033	20	CT 10033	20
34	179,0	172,05	CS 10034	16	CD 10034	20	CT 10034	20
35	184,1	177,10	CS 10035	16	CD 10035	20	CT 10035	20
36	189,1	182,15	CS 10036	20	CD 10036	20	CT 10036	25
37	194,2	187,20	CS 10037	20	CD 10037	20	CT 10037	25
38	199,2	192,24	CS 10038	20	CD 10038	20	CT 10038	25
39	204,2	197,29	CS 10039	20	CD 10039	20	CT 10039	25
40	209,3	202,34	CS 10040	20	CD 10040	20	CT 10040	25
41	214,8	207,39	CS 10041	20	CD 10041	20	CT 10041	25
42	219,9	212,44	CS 10042	20	CD 10042	20	CT 10042	25
43	224,9	217,49	CS 10043	20	CD 10043	20	CT 10043	25

Z	D <sub>e</sub>	D <sub>p</sub>	CS		CD		CT	
			cod.	D	cod.	D	cod.	D
44	230,0	222,53	CS 10044	20	CD 10044	20	CT 10044	25
45	235,0	227,58	CS 10045	20	CD 10045	20	CT 10045	25
46	240,1	232,63	CS 10046	20	CD 10046	25	CT 10046	25
47	245,1	237,68	CS 10047	20	CD 10047	25	CT 10047	25
48	250,2	242,73	CS 10048	20	CD 10048	25	CT 10048	25
49	255,2	247,78	CS 10049	20	CD 10049	25	CT 10049	25
50	260,3	252,82	CS 10050	20	CD 10050	25	CT 10050	25
51	265,3	257,87	CS 10051	20	CD 10051	25	CT 10051	25
52	270,4	262,92	CS 10052	20	CD 10052	25	CT 10052	25
53	275,4	267,97	CS 10053	20	CD 10053	25	CT 10053	25
54	280,5	273,03	CS 10054	20	CD 10054	25	CT 10054	25
55	285,5	278,08	CS 10055	20	CD 10055	25	CT 10055	25
56	290,6	283,13	CS 10056	25	CD 10056	25	CT 10056	25
57	296,0	288,18	CS 10057	25	CD 10057	25	CT 10057	25
58	300,7	293,23	CS 10058	25	CD 10058	25	CT 10058	25
59	305,7	298,27	CS 10059	25	CD 10059	25	CT 10059	25
60	310,8	303,32	CS 10060	25	CD 10060	25	CT 10060	25
62	321,4	313,43	CS 10062	25	CD 10062	25	CT 10062	30
64	331,5	323,53	CS 10064	25	CD 10064	25	CT 10064	30
65	336,5	328,58	CS 10065	25	CD 10065	25	CT 10065	30
66	341,6	333,63	CS 10066	25	CD 10066	25	CT 10066	30
68	351,7	343,74	CS 10068	25	CD 10068	25	CT 10068	30
70	361,8	353,84	CS 10070	25	CD 10070	25	CT 10070	30
72	371,9	363,95	CS 10072	25	CD 10072	25	CT 10072	30
75	387,1	379,09	CS 10075	25	CD 10075	25	CT 10075	30
76	392,1	384,16	CS 10076	25	CD 10076	25	CT 10076	30
78	402,2	394,25	CS 10078	25	CD 10078	25	CT 10078	30
80	412,3	404,35	CS 10080	25	CD 10080	25	CT 10080	30
85	437,6	429,62	CS 10085	30	CD 10085	30	CT 10085	30
90	462,8	454,88	CS 10090	30	CD 10090	30	CT 10090	30
95	488,5	480,14	CS 10095	30	CD 10095	30	CT 10095	30
100	513,4	505,40	CS 10100	30	CD 10100	30	CT 10100	30
110	563,9	555,92	CS 10110	30	CD 10110	30	CT 10110	30
114	584,1	576,13	CS 10114	30	CD 10114	30	CT 10114	30
120	614,8	606,44	CS 10120	30	CD 10120	30	CT 10120	30
125	639,7	631,71	CS 10125	30	CD 10125	30	CT 10125	30

Corone per catene semplici, doppie e triple a rulli secondo: DIN 8187 - ISO/R 606

**Corone tornite sui lati, dentate con creatore.**

Plate wheels for simplex duplex and triplex chain to: DIN 8187 - ISO/R 606

**Plate Wheels turned on both sides and toothed by milling cutter.**

Kettenradscheiben für Simplex-Duplex-Triplex-Rollenkette nach: DIN 8187 - ISO/R 606

**Seitlich plan gedrehte, wälzgefräste Zahnkränze.**

Disques pour chaînes simples, doubles et triples à rouleaux suivant les normes: DIN 8187 - ISO/R 606

**Disques tournés sur les flancs, dentés à la fraise.**

Discos para cadena simple, doble y triple de rodillos según: DIN 8187 - ISO/R 606

**Discos torneadas en los lados, dientes obtenidos con fresa madre.**

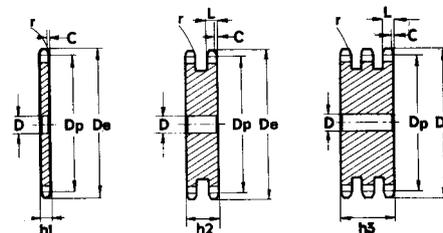
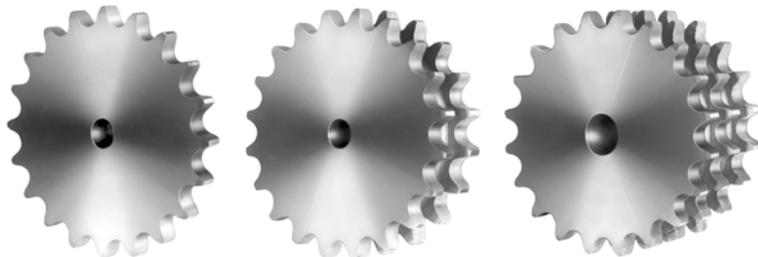

**3/4" x 7/16"**

**12B - 1-2-3 19,05 x 11,68 mm**

CATENA:	CHAIN:	KETTE:	CHAÎNE:	CADENA:	ISO mm
Passo	Pitch	Teilung	Pas	Paso	<b>19,05</b>
Larghezza interna	Internal width	Innere Breite	Largeur interieure	Ancho interno	<b>11,68</b>
Rullo ø	Roller ø	Rollen ø	ø du rouleau	Rodillo ø	<b>12,07</b>

CORONE	PLATE WHEELS	KETTENRADSCHIEBEN	DISQUES	DISCOS	ISO mm
Raggio dente r	Tooth radius r	Radius r	Rayon de denture r	Radio diente r	<b>r 19,0</b>
Larghezza raggio C	Radius width C	Breite C	Largeur de rayon C	Ancho radio C	<b>C 2,0</b>
Largh. dente h <sub>1</sub>	Tooth width h <sub>1</sub>	Zahnbreite h <sub>1</sub>	Larg. de denture h <sub>1</sub>	Ancho diente h <sub>1</sub>	<b>h<sub>1</sub> 11,1</b>
Largh. dente L	Tooth width L	Zahnbreite L	Larg. de denture L	Ancho diente L	<b>L 10,8</b>
Largh. dente h <sub>2</sub>	Tooth width h <sub>2</sub>	Zahnbreite h <sub>2</sub>	Larg. de denture h <sub>2</sub>	Ancho diente h <sub>2</sub>	<b>h<sub>2</sub> 30,3</b>
Largh. dente h <sub>3</sub>	Tooth width h <sub>3</sub>	Zahnbreite h <sub>3</sub>	Larg. de denture h <sub>3</sub>	Ancho diente h <sub>3</sub>	<b>h<sub>3</sub> 49,8</b>
Altezza totale H	Full height H	Gesamt Höhe H	Hauteur totale H	Altura total H	<b>H -</b>

Z	D <sub>e</sub>	D <sub>p</sub>	CS		CD		CT	
			cod.	D	cod.	D	cod.	D
8	57,6	49,78	CS 11008	12	CD 11008	12	CT 11008	12
9	62,0	55,70	CS 11009	12	CD 11009	12	CT 11009	12
10	69,0	61,64	CS 11010	12	CD 11010	12	CT 11010	12
11	75,0	67,61	CS 11011	14	CD 11011	14	CT 11011	16
12	81,5	73,60	CS 11012	14	CD 11012	14	CT 11012	16
13	87,5	79,59	CS 11013	14	CD 11013	14	CT 11013	16
14	93,6	85,61	CS 11014	14	CD 11014	14	CT 11014	16
15	99,8	91,63	CS 11015	14	CD 11015	14	CT 11015	16
16	105,5	97,65	CS 11016	14	CD 11016	16	CT 11016	16
17	111,5	103,67	CS 11017	14	CD 11017	16	CT 11017	16
18	118,0	109,71	CS 11018	14	CD 11018	16	CT 11018	16
19	124,2	115,75	CS 11019	14	CD 11019	16	CT 11019	16
20	129,7	121,78	CS 11020	14	CD 11020	16	CT 11020	16
21	136,0	127,82	CS 11021	16	CD 11021	16	CT 11021	20
22	141,8	133,86	CS 11022	16	CD 11022	16	CT 11022	20
23	149,0	139,90	CS 11023	16	CD 11023	16	CT 11023	20
24	153,9	145,94	CS 11024	16	CD 11024	16	CT 11024	20
25	160,0	152,00	CS 11025	16	CD 11025	16	CT 11025	20
26	165,9	158,04	CS 11026	16	CD 11026	20	CT 11026	20
27	172,3	164,09	CS 11027	16	CD 11027	20	CT 11027	20
28	178,0	170,13	CS 11028	16	CD 11028	20	CT 11028	20
29	184,1	176,19	CS 11029	16	CD 11029	20	CT 11029	20
30	190,5	182,25	CS 11030	16	CD 11030	20	CT 11030	20
31	196,3	188,31	CS 11031	20	CD 11031	20	CT 11031	25
32	203,3	194,35	CS 11032	20	CD 11032	20	CT 11032	25
33	209,3	200,40	CS 11033	20	CD 11033	20	CT 11033	25
34	214,6	206,46	CS 11034	20	CD 11034	20	CT 11034	25
35	221,0	212,52	CS 11035	20	CD 11035	20	CT 11035	25
36	226,8	218,58	CS 11036	20	CD 11036	25	CT 11036	25
37	232,9	224,64	CS 11037	20	CD 11037	25	CT 11037	25
38	239,0	230,69	CS 11038	20	CD 11038	25	CT 11038	25
39	245,1	236,75	CS 11039	20	CD 11039	25	CT 11039	25
40	251,3	242,81	CS 11040	20	CD 11040	25	CT 11040	25
41	257,3	248,87	CS 11041	25	CD 11041	25	CT 11041	25
42	264,5	254,93	CS 11042	25	CD 11042	25	CT 11042	25
43	270,5	260,98	CS 11043	25	CD 11043	25	CT 11043	25

Z	D <sub>e</sub>	D <sub>p</sub>	CS		CD		CT	
			cod.	D	cod.	D	cod.	D
44	276,5	267,03	CS 11044	25	CD 11044	25	CT 11044	25
45	282,5	273,10	CS 11045	25	CD 11045	25	CT 11045	25
46	287,9	279,16	CS 11046	25	CD 11046	25	CT 11046	25
47	294,0	285,21	CS 11047	25	CD 11047	25	CT 11047	25
48	300,1	291,27	CS 11048	25	CD 11048	25	CT 11048	25
49	306,2	297,33	CS 11049	25	CD 11049	25	CT 11049	25
50	312,3	303,39	CS 11050	25	CD 11050	25	CT 11050	25
51	318,4	309,45	CS 11051	25	CD 11051	25	CT 11051	25
52	324,5	315,50	CS 11052	25	CD 11052	25	CT 11052	25
53	330,5	321,56	CS 11053	25	CD 11053	25	CT 11053	25
54	336,6	327,64	CS 11054	25	CD 11054	25	CT 11054	25
55	342,7	333,70	CS 11055	25	CD 11055	25	CT 11055	25
56	348,7	339,75	CS 11056	25	CD 11056	25	CT 11056	30
57	355,4	345,81	CS 11057	25	CD 11057	25	CT 11057	30
58	361,5	351,87	CS 11058	25	CD 11058	25	CT 11058	30
59	367,5	357,93	CS 11059	25	CD 11059	25	CT 11059	30
60	373,0	363,99	CS 11060	25	CD 11060	25	CT 11060	30
62	385,1	376,12	CS 11062	25	CD 11062	30	CT 11062	30
64	397,2	388,24	CS 11064	25	CD 11064	30	CT 11064	30
65	403,2	394,29	CS 11065	25	CD 11065	30	CT 11065	30
66	409,2	400,35	CS 11066	30	CD 11066	30	CT 11066	30
68	421,4	412,49	CS 11068	30	CD 11068	30	CT 11068	30
70	433,6	424,60	CS 11070	30	CD 11070	30	CT 11070	30
72	447,0	436,74	CS 11072	30	CD 11072	30	CT 11072	30
75	463,9	454,91	CS 11075	30	CD 11075	30	CT 11075	30
76	469,9	460,99	CS 11076	30	CD 11076	30	CT 11076	30
78	482,1	473,10	CS 11078	30	CD 11078	30	CT 11078	30
80	494,2	485,22	CS 11080	30	CD 11080	30	CT 11080	30
85	524,5	515,55	CS 11085	30	CD 11085	30	CT 11085	30
90	554,8	545,86	CS 11090	30	CD 11090	30	CT 11090	30
95	585,1	576,17	CS 11095	30	CD 11095	30	CT 11095	30
100	615,4	606,47	CS 11100	30	CD 11100	30	CT 11100	30
110	676,1	667,11	CS 11110	30	CD 11110	30	CT 11110	30
114	700,6	691,36	CS 11114	30	CD 11114	30	CT 11114	30
120	736,7	727,74	CS 11120	30	CD 11120	30	CT 11120	30
125	767,0	758,05	CS 11125	30	CD 11125	30	CT 11125	30

Corone per catene semplici, doppie e triple a rulli secondo: DIN 8187 - ISO/R 606

**Corone tornite sui lati, dentate con creatore.**

Plate wheels for simplex duplex and triplex chain to: DIN 8187 - ISO/R 606

**Plate Wheels turned on both sides and toothed by milling cutter.**

Kettenradscheiben für Simplex-Duplex-Triplex-Rollenkette nach: DIN 8187 - ISO/R 606

**Seitlich plan gedrehte, wälzgefräste Zahnkränze.**

Disques pour chaînes simples, doubles et triples à rouleaux suivant les normes: DIN 8187 - ISO/R 606

**Disques tournés sur les flancs, dentés à la fraise.**

Discos para cadena simple, doble y triple de rodillos según: DIN 8187 - ISO/R 606

**Discos torneados en los lados, dientes obtenidos con fresa madre.**

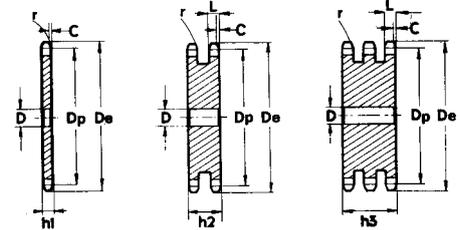
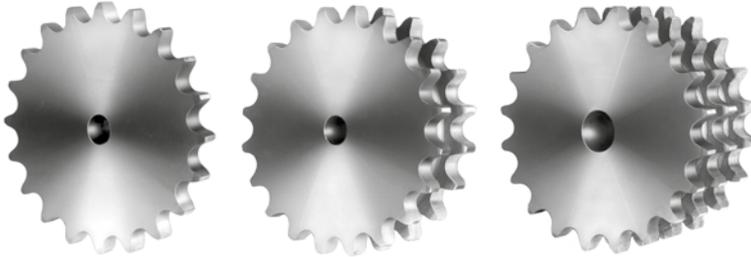

## 1" x 17,02 mm

## 16B - 1-2-3 25,4 x 17,02 mm

CATENA:	CHAIN:	KETTE:	CHAÎNE:	CADENA:	ISO mm
Passo	Pitch	Teilung	Pas	Paso	<b>25,40</b>
Larghezza interna	Internal width	Innere Breite	Largeur interieure	Ancho interno	<b>17,02</b>
Rullo ø	Roller ø	Rollen ø	ø du rouleau	Rodillo ø	<b>15,88</b>

CORONE	PLATE WHEELS	KETTENRADSCHIEBEN	DISQUES	DISCOS	ISO mm
Raggio dente r	Tooth radius r	Radius r	Rayon de denture r	Radio diente r	<b>r 26,0</b>
Larghezza raggio C	Radius width C	Breite C	Largeur de rayon C	Ancho radio C	<b>C 2,5</b>
Largh. dente h <sub>1</sub>	Tooth width h <sub>1</sub>	Zahnbreite h <sub>1</sub>	Larg. de denture h <sub>1</sub>	Ancho diente h <sub>1</sub>	<b>h<sub>1</sub> 16,2</b>
Largh. dente L	Tooth width L	Zahnbreite L	Larg. de denture L	Ancho diente L	<b>L 15,8</b>
Largh. dente h <sub>2</sub>	Tooth width h <sub>2</sub>	Zahnbreite h <sub>2</sub>	Larg. de denture h <sub>2</sub>	Ancho diente h <sub>2</sub>	<b>h<sub>2</sub> 47,7</b>
Largh. dente h <sub>3</sub>	Tooth width h <sub>3</sub>	Zahnbreite h <sub>3</sub>	Larg. de denture h <sub>3</sub>	Ancho diente h <sub>3</sub>	<b>h<sub>3</sub> 79,6</b>
Altezza totale H	Full height H	Gesamt Höhe H	Hauteur totale H	Altura total H	<b>H -</b>

Z	D <sub>e</sub>	D <sub>p</sub>	CS		CD		CT	
			cod.	D	cod.	D	cod.	D
8	77,0	66,37	CS 12008	12	CD 12008	16	CT 12008	20
9	85,0	74,27	CS 12009	12	CD 12009	16	CT 12009	20
10	93,0	82,19	CS 12010	15	CD 12010	16	CT 12010	20
11	99,5	90,14	CS 12011	15	CD 12011	20	CT 12011	20
12	109,0	98,14	CS 12012	15	CD 12012	20	CT 12012	20
13	117,0	106,12	CS 12013	15	CD 12013	20	CT 12013	20
14	125,0	114,15	CS 12014	15	CD 12014	20	CT 12014	20
15	133,0	122,17	CS 12015	15	CD 12015	20	CT 12015	20
16	141,0	130,20	CS 12016	19	CD 12016	20	CT 12016	30
17	149,0	138,22	CS 12017	19	CD 12017	20	CT 12017	30
18	157,0	146,28	CS 12018	19	CD 12018	20	CT 12018	30
19	165,2	154,33	CS 12019	19	CD 12019	20	CT 12019	30
20	173,2	162,38	CS 12020	19	CD 12020	20	CT 12020	30
21	181,2	170,43	CS 12021	20	CD 12021	25	CT 12021	30
22	189,3	178,48	CS 12022	20	CD 12022	25	CT 12022	30
23	197,5	186,53	CS 12023	20	CD 12023	25	CT 12023	30
24	205,5	194,59	CS 12024	20	CD 12024	25	CT 12024	30
25	213,5	202,66	CS 12025	20	CD 12025	25	CT 12025	30
26	221,6	210,72	CS 12026	20	CD 12026	25	CT 12026	30
27	229,6	218,79	CS 12027	20	CD 12027	25	CT 12027	30
28	237,7	226,85	CS 12028	20	CD 12028	25	CT 12028	30
29	245,8	234,92	CS 12029	20	CD 12029	25	CT 12029	30
30	254,0	243,00	CS 12030	20	CD 12030	25	CT 12030	30
31	262,0	251,08	CS 12031	25	CD 12031	25	CT 12031	30
32	270,0	259,13	CS 12032	25	CD 12032	25	CT 12032	30
33	278,5	267,21	CS 12033	25	CD 12033	25	CT 12033	30
34	287,0	275,28	CS 12034	25	CD 12034	25	CT 12034	30
35	296,2	283,36	CS 12035	25	CD 12035	25	CT 12035	30
36	304,6	291,44	CS 12036	25	CD 12036	25	CT 12036	30
37	312,6	299,51	CS 12037	25	CD 12037	25	CT 12037	30
38	320,7	307,59	CS 12038	25	CD 12038	25	CT 12038	30
39	328,8	315,67	CS 12039	25	CD 12039	25	CT 12039	30
40	336,9	323,73	CS 12040	25	CD 12040	25	CT 12040	30
41	345,0	331,82	CS 12041	25				
42	353,0	339,90	CS 12042	25	CD 12042	25	CT 12042	30
43	361,1	347,98	CS 12043	25	CD 12043	25		

Z	D <sub>e</sub>	D <sub>p</sub>	CS		CD		CT	
			cod.	D	cod.	D	cod.	D
44	369,1	356,06	CS 12044	25	CD 12044	25	CT 12044	30
45	377,1	364,12	CS 12045	25	CD 12045	25	CT 12045	30
46	385,2	372,21	CS 12046	25	CD 12046	30	CT 12046	30
47	393,2	380,29	CS 12047	25				
48	401,3	388,36	CS 12048	25	CD 12048	30	CT 12048	30
49	409,3	396,44	CS 12049	25				
50	417,4	404,52	CS 12050	25	CD 12050	30	CT 12050	30
51	425,5	412,60	CS 12051	30	CD 12051	30	CT 12051	40
52	433,6	420,67	CS 12052	30	CD 12052	30	CT 12052	40
53	441,7	428,75	CS 12053	30				
54	448,3	436,85	CS 12054	30				
55	457,9	444,93	CS 12055	30	CD 12055	30	CT 12055	40
56	466,0	453,01	CS 12056	30	CD 12056	30		
57	474,0	461,07	CS 12057	30	CD 12057	30	CT 12057	40
58	482,1	469,16	CS 12058	30				
59	490,2	477,24	CS 12059	30				
60	498,3	485,32	CS 12060	30	CD 12060	30	CT 12060	40
62	514,5	501,50	CS 12062	30	CD 12062	30		
64	530,7	517,65	CS 12064	30				
65	538,8	525,73	CS 12065	30	CD 12065	30	CT 12065	40
66	546,8	533,80	CS 12066	30				
68	562,9	549,98	CS 12068	30	CD 12068	30	CT 12068	40
70	579,2	566,14	CS 12070	30	CD 12070	30	CT 12070	40
72	595,4	582,32	CS 12072	30	CD 12072	30	CT 12072	40
75	619,7	606,55	CS 12075	30	CD 12075	30	CT 12075	40
76	627,0	614,65	CS 12076	30	CD 12076	30	CT 12076	40
78	643,3	630,80	CS 12078	30				
80	660,0	646,96	CS 12080	30	CD 12080	30	CT 12080	40
85	699,9	687,40	CS 12085	30	CD 12085	30	CT 12085	40
90	740,3	727,81	CS 12090	30	CD 12090	30	CT 12090	40
95	781,1	768,22	CS 12095	30	CD 12095	30	CT 12095	40
100	821,1	808,63	CS 12100	30	CD 12100	30	CT 12100	40
110	902,0	889,48	CS 12110	30	CD 12110	30	CT 12110	40
114	934,3	921,81	CS 12114	30	CD 12114	40	CT 12114	40
120	982,8	970,33	CS 12120	30	CD 12120	40	CT 12120	40
125	1023,2	1010,73	CS 12125	30	CD 12125	40	CT 12125	40

Corone per catene semplici, doppie e triple a rulli secondo: DIN 8187 - ISO/R 606

**Corone tornite sui lati, dentate con creatore.**

Plate wheels for simplex duplex and triplex chain to: DIN 8187 - ISO/R 606

**Plate Wheels turned on both sides and toothed by milling cutter.**

Kettenradscheiben für Simplex-Duplex-Triplex-Rollenkette nach: DIN 8187 - ISO/R 606

**Seitlich plan gedrehte, wälzgefräste Zahnkränze.**

Disques pour chaînes simples, doubles et triples à rouleaux suivant les normes: DIN 8187 - ISO/R 606

**Disques tournés sur les flancs, dentés à la fraise.**

Discos para cadena simple, doble y triple de rodillos segun: DIN 8187 - ISO/R 606

**Discos torneados en los lados, dientes obtenidos con fresa madre.**

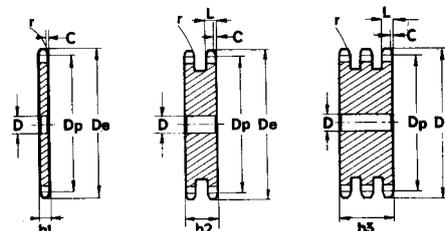
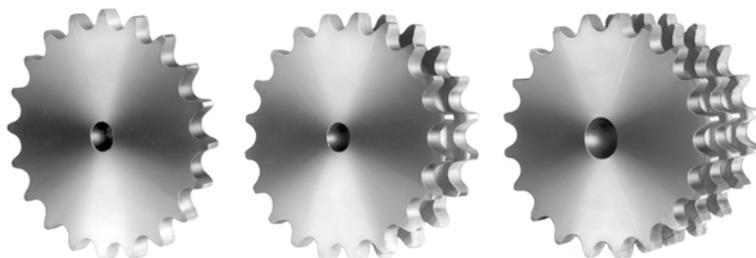

**1"1/4 x 3/4"**

**20B - 1-2-3 31,75 x 19,56 mm**

CATENA:	CHAIN:	KETTE:	CHAÎNE:	CADENA:	ISO mm
Passo	Pitch	Teilung	Pas	Paso	<b>31,75</b>
Larghezza interna	Internal width	Innere Breite	Largeur interieure	Ancho interno	<b>19,56</b>
Rullo ø	Roller ø	Rollen ø	ø du rouleau	Rodillo ø	<b>19,05</b>

CORONE	PLATE WHEELS	KETTENRADSCHIEBEN	DISQUES	DISCOS	ISO mm
Raggio dente r	Tooth radius r	Radius r	Rayon de denture r	Radio diente r	<b>r 32,0</b>
Larghezza raggio C	Radius width C	Breite C	Largeur de rayon C	Ancho radio C	<b>C 3,5</b>
Largh. dente h <sub>1</sub>	Tooth width h <sub>1</sub>	Zahnbreite h <sub>1</sub>	Larg. de denture h <sub>1</sub>	Ancho diente h <sub>1</sub>	<b>h<sub>1</sub> 18,5</b>
Largh. dente L	Tooth width L	Zahnbreite L	Larg. de denture L	Ancho diente L	<b>L 18,2</b>
Largh. dente h <sub>2</sub>	Tooth width h <sub>2</sub>	Zahnbreite h <sub>2</sub>	Larg. de denture h <sub>2</sub>	Ancho diente h <sub>2</sub>	<b>h<sub>2</sub> 54,6</b>
Largh. dente h <sub>3</sub>	Tooth width h <sub>3</sub>	Zahnbreite h <sub>3</sub>	Larg. de denture h <sub>3</sub>	Ancho diente h <sub>3</sub>	<b>h<sub>3</sub> 91,0</b>
Altezza totale H	Full height H	Gesamt Höhe H	Hauteur totale H	Altura total H	<b>H -</b>

Z	D <sub>e</sub>	D <sub>p</sub>	CS		CD		CT	
			cod.	D	cod.	D	cod.	D
8	98,1	82,96	CS 13008	16	CD 13008	20	CT 13008	20
9	108,0	92,84	CS 13009	16	CD 13009	20	CT 13009	20
10	117,9	102,74	CS 13010	16	CD 13010	20	CT 13010	20
11	127,8	112,68	CS 13011	20	CD 13011	20	CT 13011	20
12	137,8	122,68	CS 13012	20	CD 13012	20	CT 13012	20
13	147,8	132,65	CS 13013	20	CD 13013	20	CT 13013	20
14	157,8	142,68	CS 13014	20	CD 13014	20	CT 13014	20
15	167,9	152,72	CS 13015	20	CD 13015	20	CT 13015	20
16	177,9	162,75	CS 13016	20	CD 13016	25	CT 13016	25
17	187,9	172,78	CS 13017	20	CD 13017	25	CT 13017	25
18	198,0	182,85	CS 13018	20	CD 13018	25	CT 13018	25
19	208,1	192,91	CS 13019	20	CD 13019	25	CT 13019	25
20	218,1	202,98	CS 13020	20	CD 13020	25	CT 13020	25
21	228,2	213,04	CS 13021	25	CD 13021	25	CT 13021	25
22	238,3	223,11	CS 13022	25	CD 13022	25	CT 13022	25
23	248,3	233,17	CS 13023	25	CD 13023	25	CT 13023	25
24	258,4	243,23	CS 13024	25	CD 13024	25	CT 13024	25
25	268,5	253,33	CS 13025	25	CD 13025	25	CT 13025	25
26	278,6	263,40	CS 13026	25	CD 13026	25	CT 13026	25
27	288,6	273,48	CS 13027	25	CD 13027	25	CT 13027	25
28	298,7	283,56	CS 13028	25	CD 13028	25	CT 13028	25
29	308,8	293,65	CS 13029	25	CD 13029	25	CT 13029	25
30	318,9	303,75	CS 13030	25	CD 13030	25	CT 13030	25
31	329,0	313,85	CS 13031	25	CD 13031	25	CT 13031	30
32	339,1	323,91	CS 13032	25	CD 13032	25	CT 13032	30
33	349,2	334,01	CS 13033	25	CD 13033	25	CT 13033	30
34	359,3	334,10	CS 13034	25	CD 13034	25	CT 13034	30
35	369,4	354,20	CS 13035	25	CD 13035	25	CT 13035	30
36	379,5	364,30	CS 13036	25	CD 13036	30	CT 13036	30
37	389,5	374,39	CS 13037	25	CD 13037	30	CT 13037	30
38	399,6	384,49	CS 13038	25	CD 13038	30	CT 13038	30
39	409,7	394,59	CS 13039	25	CD 13039	30	CT 13039	30
40	419,8	404,66	CS 13040	25	CD 13040	30	CT 13040	30
41	429,9	414,78	CS 13041	30				
42	440,0	424,88	CS 13042	30	CD 13042	30	CT 13042	40
43	450,1	434,97	CS 13043	30				

Z	D <sub>e</sub>	D <sub>p</sub>	CS		CD		CT	
			cod.	D	cod.	D	cod.	D
44	460,2	445,07	CS 13044	30				
45	470,3	455,17	CS 13045	30	CD 13045	30	CT 13045	40
46	480,4	465,26	CS 13046	30	CD 13046	30	CT 13046	40
47	490,5	475,36	CS 13047	30				
48	500,6	485,46	CS 13048	30	CD 13048	30	CT 13048	40
49	510,7	495,55	CS 13049	30				
50	520,8	505,65	CS 13050	30	CD 13050	30	CT 13050	40
51	530,9	515,75	CS 13051	30				
52	541,0	525,84	CS 13052	30	CD 13052	30	CT 13052	40
53	551,1	535,94	CS 13053	30				
54	561,2	546,07	CS 13054	30				
55	571,3	556,16	CS 31055	30	CD 13055	30	CT 13055	40
56	581,4	566,26	CS 13056	30				
57	591,5	576,36	CS 13057	30	CD 13057	30	CT 13057	40
58	601,6	586,45	CS 13058	30				
59	611,7	596,55	CS 13059	30				
60	621,8	606,65	CS 13060	30	CD 13060	30	CT 13060	40
62	642,0	626,87	CS 13062	30				
64	662,2	647,06	CS 13064	30				
65	672,3	657,16	CS 13065	30	CD 13065	30	CT 13065	40
66	682,4	667,26	CS 13066	30				
68	702,6	687,48	CS 13068	30				
70	722,8	707,67	CS 13070	30	CD 13070	30	CT 13070	40
72	743,1	727,90	CS 13072	30				
75	773,3	758,19	CS 13075	30				
76	783,5	768,32	CS 13076	30	CD 13076	30	CT 13076	40
80	823,9	808,72	CS 13080	30	CD 13080	30	CT 13080	40
85	874,4	859,25	CS 13085	30				
90	924,9	909,76	CS 13090	30				
95	975,2	960,28	CS 13095	30	CD 13095	30	CT 13095	40
100	1026,0	1010,79	CS 13100	30				
114	1167,4	1152,26	CS 13114	30	CD 13114	30	CT 13114	40

Corone per catene semplici, doppie e triple a rulli secondo: DIN 8187 - ISO/R 606

**Corone tornite sui lati, dentate con creatore.**

Plate wheels for simplex duplex and triplex chain to: DIN 8187 - ISO/R 606

**Plate Wheels turned on both sides and toothed by milling cutter.**

Kettenradscheiben für Simplex-Duplex-Triplex-Rollenkette nach: DIN 8187 - ISO/R 606

**Seitlich plan gedrehte, wälzgefräste Zahnkränze.**

Disques pour chaînes simples, doubles et triples à rouleaux suivant les normes: DIN 8187 - ISO/R 606

**Disques tournés sur les flancs, dentés à la fraise.**

Discos para cadena simple, doble y triple de rodillos según: DIN 8187 - ISO/R 606

**Discos torneadas en los lados, dientes obtenidos con fresa madre.**

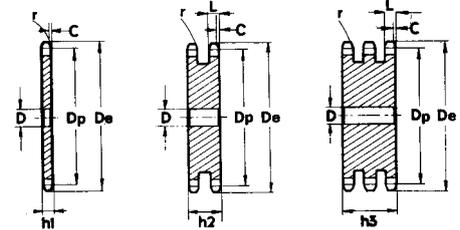
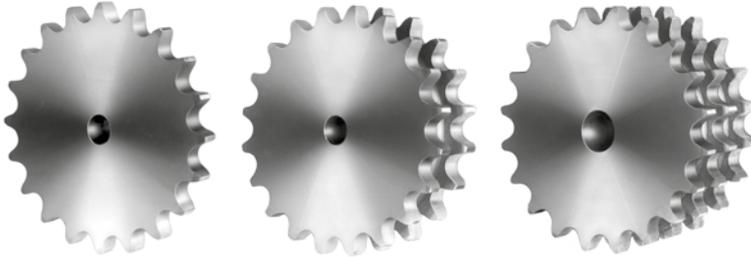

**1"1/2 x 1"**

**24B - 1-2-3 38,1 x 25,4 mm**

CATENA:	CHAIN:	KETTE:	CHAÎNE:	CADENA:	ISO mm
Passo	Pitch	Teilung	Pas	Paso	<b>38,1</b>
Larghezza interna	Internal width	Innere Breite	Largeur interieure	Ancho interno	<b>25,4</b>
Rullo ø	Roller ø	Rollen ø	ø du rouleau	Rodillo ø	<b>25,4</b>

CORONE	PLATE WHEELS	KETTENRADSCHIEBEN	DISQUES	DISCOS	ISO mm
Raggio dente r	Tooth radius r	Radius r	Rayon de denture r	Radio diente r	<b>r 38,0</b>
Larghezza raggio C	Radius width C	Breite C	Largeur de rayon C	Ancho radio C	<b>C 4,0</b>
Largh. dente h <sub>1</sub>	Tooth width h <sub>1</sub>	Zahnbreite h <sub>1</sub>	Larg. de denture h <sub>1</sub>	Ancho diente h <sub>1</sub>	<b>h<sub>1</sub> 24,1</b>
Largh. dente L	Tooth width L	Zahnbreite L	Larg. de denture L	Ancho diente L	<b>L 23,6</b>
Largh. dente h <sub>2</sub>	Tooth width h <sub>2</sub>	Zahnbreite h <sub>2</sub>	Larg. de denture h <sub>2</sub>	Ancho diente h <sub>2</sub>	<b>h<sub>2</sub> 72,0</b>
Largh. dente h <sub>3</sub>	Tooth width h <sub>3</sub>	Zahnbreite h <sub>3</sub>	Larg. de denture h <sub>3</sub>	Ancho diente h <sub>3</sub>	<b>h<sub>3</sub> 120,3</b>
Altezza totale H	Full height H	Gesamt Höhe H	Hauteur totale H	Altura total H	<b>H -</b>

Z	D <sub>e</sub>	D <sub>p</sub>	CS		CD		CT	
			cod.	D	cod.	D	cod.	D
8	115,0	99,55	CS 14008	20	CD 14008	25	CT 14008	25
9	126,4	111,40	CS 14009	20	CD 14009	25	CT 14009	25
10	138,0	123,29	CS 14010	20	CD 14010	25	CT 14010	25
11	150,0	135,21	CS 14011	20	CD 14011	25	CT 14011	25
12	162,0	147,22	CS 14012	20	CD 14012	25	CT 14012	25
13	174,2	159,18	CS 14013	20	CD 14013	25	CT 14013	25
14	186,2	171,22	CS 14014	20	CD 14014	25	CT 14014	25
15	198,2	183,26	CS 14015	20	CD 14015	25	CT 14015	25
16	210,3	195,30	CS 14016	25	CD 14016	25	CT 14016	25
17	222,3	207,34	CS 14017	25	CD 14017	25	CT 14017	25
18	234,3	219,42	CS 14018	25	CD 14018	25	CT 14018	25
19	246,5	231,49	CS 14019	25	CD 14019	25	CT 14019	25
20	258,6	243,57	CS 14020	25	CD 14020	25	CT 14020	25
21	270,6	255,65	CS 14021	25	CD 14021	25	CT 14021	30
22	282,7	267,73	CS 14022	25	CD 14022	25	CT 14022	30
23	294,8	279,80	CS 14023	25	CD 14023	25	CT 14023	30
24	306,8	291,88	CS 14024	25	CD 14024	25	CT 14024	30
25	319,0	304,00	CS 14025	25	CD 14025	25	CT 14025	30
26	331,0	316,08	CS 14026	30	CD 14026	30	CT 14026	30
27	343,2	328,19	CS 14027	30	CD 14027	30	CT 14027	30
28	355,2	340,27	CS 14028	30	CD 14028	30	CT 14028	30
29	367,3	352,38	CS 14029	30	CD 14029	30	CT 14029	30
30	379,5	364,50	CS 14030	30	CD 14030	30	CT 14030	40
31	391,6	376,62	CS 14031	30	CD 14031	40	CT 14031	40
32	403,7	388,69	CS 14032	30	CD 14032	40	CT 14032	40
33	415,8	400,81	CS 14033	30	CD 14033	40	CT 14033	40
34	427,8	412,93	CS 14034	30	CD 14034	40	CT 14034	40
35	440,0	425,04	CS 14035	30	CD 14035	40	CT 14035	40
36	452,0	437,16	CS 14036	30	CD 14036	40	CT 14036	40
37	464,2	449,27	CS 14037	30	CD 14037	40	CT 14037	40
38	476,2	461,39	CS 14038	30	CD 14038	40	CT 14038	40
39	488,5	473,50	CS 14039	30	CD 14039	40	CT 14039	40
40	500,6	485,62	CS 14040	30	CD 14040	40	CT 14040	40

Z	D <sub>e</sub>	D <sub>p</sub>	CS		CD		CT	
			cod.	D	cod.	D	cod.	D
41	512,6	497,74	CS 14041	30				
42	524,7	509,85	CS 14042	30	CD 14042	40	CT 14042	40
43	536,8	521,97	CS 14043	30				
44	549,0	534,08	CS 14044	30				
45	561,2	546,20	CS 14045	30	CD 14045	40	CT 14045	40
46	573,3	558,32	CS 14046	30	CD 14046	40	CT 14046	40
47	585,4	570,43	CS 14047	30				
48	597,4	582,55	CS 14048	30	CD 14048	40	CT 14048	40
49	609,5	594,66	CS 14049	30				
50	621,7	606,78	CS 14050	30	CD 14050	40	CT 14050	40
51	633,8	618,89	CS 14051	30				
52	646,0	631,01	CS 14052	30				
53	658,0	643,13	CS 14053	30				
54	670,2	655,25	CS 14054	30				
55	682,3	667,40	CS 14055	30	CD 14055	40	CT 14055	40
56	694,4	679,50	CS 14056	30				
57	706,5	691,73	CS 14057	30	CD 14057	40	CT 14057	40
58	718,6	703,74	CS 14058	30				
59	730,7	715,86	CS 14059	30				
60	742,8	727,97	CS 14060	30	CD 14060	40	CT 14060	40
62	767,2	752,24	CS 14062	40				
64	791,3	776,48	CS 14064	40				
65	803,4	788,59	CS 14065	40	CD 14065	40	CT 14065	40
66	815,6	800,17	CS 14066	40				
68	839,8	824,98	CS 14068	40				
70	864,2	849,21	CS 14070	40				
72	888,4	873,48	CS 14072	40				
75	924,8	909,83	CS 14075	40				
76	936,9	921,98	CS 14076	40	CD 14076	40	CT 14076	40
80	985,4	970,44	CS 14080	40				
85	1046,0	1031,10	CS 14085	40				
95	1167,3	1152,33	CS 14095	40				



Corone per catene semplici, doppie e triple a rulli secondo: DIN 8187 - ISO/R 606

**Corone tornite sui lati, dentate con creatore.**

Plate wheels for simplex duplex and triplex chain to: DIN 8187 - ISO/R 606

**Plate Wheels turned on both sides and toothed by milling cutter.**

Kettenradscheiben für Simplex-Duplex-Triplex-Rollenkette nach: DIN 8187 - ISO/R 606

**Seitlich plan gedrehte, wälzgefräste Zahnkränze.**

Disques pour chaînes simples, doubles et triples à rouleaux suivant les normes: DIN 8187 - ISO/R 606

**Disques tournés sur les flancs, dentés à la fraise.**

Discos para cadena simple, doble y triple de rodillos según: DIN 8187 - ISO/R 606

**Discos torneadas en los lados, dientes obtenidos con fresa madre.**

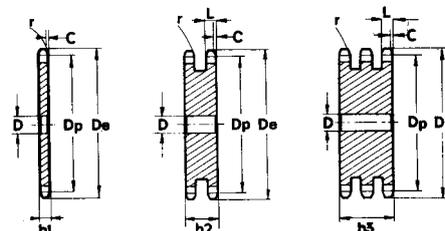
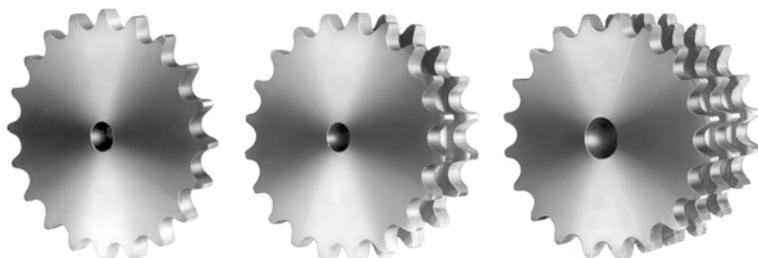

**1"3/4 x 1"1/4**

**28B - 1-2-3 44,45 x 30,99 mm**

CATENA:	CHAIN:	KETTE:	CHAÎNE:	CADENA:	ISO mm
Passo	Pitch	Teilung	Pas	Paso	<b>44,45</b>
Larghezza interna	Internal width	Innere Breite	Largeur interieure	Ancho interno	<b>30,99</b>
Rullo ø	Roller ø	Rollen ø	ø du rouleau	Rodillo ø	<b>27,94</b>

CORONE	PLATE WHEELS	KETTENRADSCHIEBEN	DISQUES	DISCOS	ISO mm
Raggio dente r	Tooth radius r	Radius r	Rayon de denture r	Radio diente r	<b>r 44,0</b>
Larghezza raggio C	Radius width C	Breite C	Largeur de rayon C	Ancho radio C	<b>C 5,0</b>
Largh. dente h <sub>1</sub>	Tooth width h <sub>1</sub>	Zahnbreite h <sub>1</sub>	Larg. de denture h <sub>1</sub>	Ancho diente h <sub>1</sub>	<b>h<sub>1</sub> 29,4</b>
Largh. dente L	Tooth width L	Zahnbreite L	Larg. de denture L	Ancho diente L	<b>L 28,8</b>
Largh. dente h <sub>2</sub>	Tooth width h <sub>2</sub>	Zahnbreite h <sub>2</sub>	Larg. de denture h <sub>2</sub>	Ancho diente h <sub>2</sub>	<b>h<sub>2</sub> 88,4</b>
Largh. dente h <sub>3</sub>	Tooth width h <sub>3</sub>	Zahnbreite h <sub>3</sub>	Larg. de denture h <sub>3</sub>	Ancho diente h <sub>3</sub>	<b>h<sub>3</sub> 148,0</b>
Altezza totale H	Full height H	Gesamt Höhe H	Hauteur totale H	Altura total H	<b>H -</b>

Z	D <sub>e</sub>	D <sub>p</sub>	CS		CD		CT	
			cod.	D	cod.	D	cod.	D
8	132,0	116,15	CS 15008	25	CD 15008	25	CT 15008	25
9	148,4	129,96	CS 15009	25	CD 15009	25	CT 15009	25
10	162,3	143,85	CS 15010	25	CD 15010	25	CT 15010	25
11	176,3	157,77	CS 15011	25	CD 15011	25	CT 15011	30
12	189,3	171,74	CS 15012	25	CD 15012	25	CT 15012	30
13	204,2	185,75	CS 15013	25	CD 15013	25	CT 15013	30
14	218,2	199,76	CS 15014	25	CD 15014	25	CT 15014	30
15	232,3	213,79	CS 15015	25	CD 15015	25	CT 15015	30
16	246,3	227,84	CS 15016	30	CD 15016	30	CT 15016	30
17	260,0	241,90	CS 15017	30	CD 15017	30	CT 15017	30
18	274,0	255,98	CS 15018	30	CD 15018	30	CT 15018	30
19	289,0	270,06	CS 15019	30	CD 15019	30	CT 15019	30
20	303,0	284,15	CS 15020	30	CD 15020	30	CT 15020	30
21	317,0	298,24	CS 15021	30	CD 15021	30	CT 15021	30
22	331,0	312,34	CS 15022	30	CD 15022	30	CT 15022	30
23	345,0	326,44	CS 15023	30	CD 15023	30	CT 15023	30
24	359,0	340,55	CS 15024	30	CD 15024	30	CT 15024	30
25	373,0	354,66	CS 15025	30	CD 15025	30	CT 15025	40
26	387,0	368,77	CS 15026	30	CD 15026	30	CT 15026	40
27	401,0	382,88	CS 15027	30	CD 15027	30	CT 15027	40
28	416,0	397,00	CS 15028	30	CD 15028	30	CT 15028	40
29	430,0	411,12	CS 15029	30	CD 15029	30	CT 15029	40
30	444,0	425,24	CS 15030	30	CD 15030	30	CT 15030	40
31	458,0	439,37	CS 15031	30	CD 15031	30	CT 15031	40
32	472,0	453,49	CS 15032	30	CD 15032	30	CT 15032	40
33	486,0	467,62	CS 15033	30	CD 15033	30	CT 15033	40
34	500,0	481,75	CS 15034	30	CD 15034	30	CT 15034	40
35	514,0	495,88	CS 15035	30	CD 15035	30	CT 15035	40
36	529,0	510,01	CS 15036	30	CD 15036	30	CT 15036	40
37	543,0	524,13	CS 15037	30	CD 15037	30	CT 15037	40
38	557,0	538,27	CS 15038	30	CD 15038	30	CT 15038	40
39	571,0	552,40	CS 15039	30	CD 15039	30	CT 15039	40
40	585,0	566,54	CS 15040	30	CD 15040	30	CT 15040	40
45	656,0	637,22	CS 15045	30	CD 15045	30	CT 15045	40
50	726,0	707,91	CS 15050	30	CD 15050	30	CT 15050	40
57	825,0	806,90	CS 15057	40	CD 15057	40	CT 15057	40
60	869,0	849,32	CS 15060	40	CD 15060	40	CT 15060	40
76	1095,0	1075,62	CS 15076	40	CD 15076	40	CT 15076	40

Corone per catene semplici, doppie e triple a rulli secondo: DIN 8187 - ISO/R 606

**Corone tornite sui lati, dentate con creatore.**

Plate wheels for simplex duplex and triplex chain to: DIN 8187 - ISO/R 606

**Plate Wheels turned on both sides and toothed by milling cutter.**

Kettenradscheiben für Simplex-Duplex-Triplex-Rollenkette nach: DIN 8187 - ISO/R 606

**Seitlich plan gedrehte, wälzgefräste Zahnkränze.**

Disques pour chaînes simples, doubles et triples à rouleaux suivant les normes: DIN 8187 - ISO/R 606

**Disques tournés sur les flancs, dentés à la fraise.**

Discos para cadena simple, doble y triple de rodillos según: DIN 8187 - ISO/R 606

**Discos torneadas en los lados, dientes obtenidos con fresa madre.**

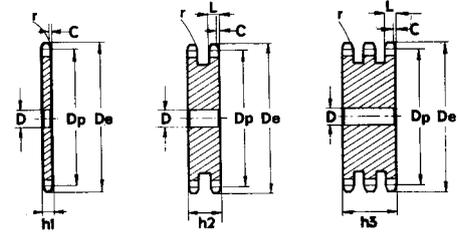
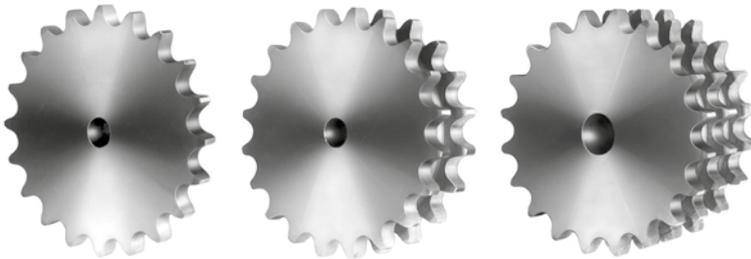

## 2" x 1 1/4

## 32B - 1-2-3 50,8 x 30,99 mm

CATENA:	CHAIN:	KETTE:	CHAÎNE:	CADENA:	ISO mm
Passo	Pitch	Teilung	Pas	Paso	<b>50,8</b>
Larghezza interna	Internal width	Innere Breite	Largeur interieure	Ancho interno	<b>30,99</b>
Rullo ø	Roller ø	Rollen ø	ø du rouleau	Rodillo ø	<b>29,21</b>

CORONE	PLATE WHEELS	KETTENRADSCHIEBEN	DISQUES	DISCOS	ISO mm
Raggio dente r	Tooth radius r	Radius r	Rayon de denture r	Radio diente r	<b>r 51</b>
Larghezza raggio C	Radius width C	Breite C	Largeur de rayon C	Ancho radio C	<b>C 6</b>
Largh. dente h <sub>1</sub>	Tooth width h <sub>1</sub>	Zahnbreite h <sub>1</sub>	Larg. de denture h <sub>1</sub>	Ancho diente h <sub>1</sub>	<b>h<sub>1</sub> 29,4</b>
Largh. dente L	Tooth width L	Zahnbreite L	Larg. de denture L	Ancho diente L	<b>L 28,8</b>
Largh. dente h <sub>2</sub>	Tooth width h <sub>2</sub>	Zahnbreite h <sub>2</sub>	Larg. de denture h <sub>2</sub>	Ancho diente h <sub>2</sub>	<b>h<sub>2</sub> 87,4</b>
Largh. dente h <sub>3</sub>	Tooth width h <sub>3</sub>	Zahnbreite h <sub>3</sub>	Larg. de denture h <sub>3</sub>	Ancho diente h <sub>3</sub>	<b>h<sub>3</sub> 146</b>
Altezza totale H	Full height H	Gesamt Höhe H	Hauteur totale H	Altura total H	<b>H -</b>

Z	D <sub>e</sub>	D <sub>p</sub>	CS		CD		CT	
			cod.	D	cod.	D	cod.	D
8	153,2	132,74	CS 16008	25	CD 16008	25	CT 16008	25
9	169,0	148,54	CS 16009	25	CD 16009	25	CT 16009	25
10	185,0	164,39	CS 16010	25	CD 16010	25	CT 16010	25
11	200,8	180,31	CS 16011	30	CD 16011	30	CT 16011	30
12	216,8	196,29	CS 16012	30	CD 16012	30	CT 16012	30
13	232,8	212,29	CS 16013	30	CD 16013	30	CT 16013	30
14	248,8	228,29	CS 16014	30	CD 16014	30	CT 16014	30
15	264,8	244,30	CS 16015	30	CD 16015	30	CT 16015	30
16	280,9	260,40	CS 16016	30	CD 16016	30	CT 16016	30
17	296,9	276,46	CS 16017	30	CD 16017	30	CT 16017	30
18	313,0	292,55	CS 16018	30	CD 16018	30	CT 16018	30
19	329,1	308,66	CS 16019	30	CD 16019	30	CT 16019	30
20	345,2	324,71	CS 16020	30	CD 16020	30	CT 16020	30
21	361,3	340,82	CS 16021	30	CD 16021	30	CT 16021	40
22	377,5	356,98	CS 16022	30	CD 16022	30	CT 16022	40
23	393,6	373,08	CS 16023	30	CD 16023	30	CT 16023	40
24	409,7	389,18	CS 16024	30	CD 16024	30	CT 16024	40
25	425,8	405,33	CS 16025	30	CD 16025	30	CT 16025	40
26	441,9	421,44	CS 16026	30	CD 16026	30	CT 16026	40
27	458,1	437,59	CS 16027	30	CD 16027	30	CT 16027	40
28	474,2	453,69	CS 16028	30	CD 16028	30	CT 16028	40
29	492,0	469,85	CS 16029	30	CD 16029	30	CT 16029	40
30	506,5	486,00	CS 16030	30	CD 16030	30	CT 16030	40
32	538,8	518,27	CS 16032	30				
35	589,5	566,71	CS 16035	30	CD 16035	30	CT 16035	40
38	635,5	615,16	CS 16038	30	CD 16038	30	CT 16038	40
40	670,3	647,47	CS 16040	40	CD 16040	40	CT 16040	40
45	751,0	728,24	CS 16045	40	CD 16045	40	CT 16045	40
50	831,8	809,04	CS 16050	40	CD 16050	40	CT 16050	40
57	945,0	922,16	CS 16057	40	CD 16057	40	CT 16057	40
60	993,4	970,65	CS 16060	40	CD 16060	40	CT 16060	40
76	1252,0	1229,27	CS 16076	40	CD 16076	40	CT 16076	40

**Corone doppie per due catene semplici**  
**Duplex plate wheels for two single chains**  
**Zweifach-Scheiben für zwei einfach-Ketten**  
**Disques doubles pour deux chaînes simples**  
**Discos dobles para dos cadenas simples**

I valori Di-Dp-De-C-L-r sono da ricavare dalle pagg. 52, 57, 58, 59, 60

See page no. 52, 57, 58, 59, 60 for Di-Dp-De-C-L-r dimensions

Siehe Seite Nr. 52, 57, 58, 59, 60 fuer Di-Dp-De-C-L-r Abmessungen

Voir page no. 52, 57, 58, 59, 60 pour les dimensions Di-Dp-De-C-L-r

Valor Di-Dp-De-C-L-r se deben obtener de las paginas 52, 57, 58, 59, 60

**Materiale C 45 E**  
**UNI EN 10083-1**

**Material C 45 E**  
**UNI EN 10083-1**

**Werkstoff C 45 E**  
**UNI EN 10083-1**

**Matière C 45 E**  
**UNI EN 10083-1**

**Material C 45 E**  
**UNI EN 10083-1**

cod.	Z	3/8" x 7/32" - 06B R.6,35				
		h <sub>2</sub>	F	F <sub>1</sub>	Db	D
DS 05013	13	24,3	19	13,7	28	10
DS 05014	14	24,3	19	13,7	31	10
DS 05015	15	24,3	19	13,7	34	10
DS 05016	16	24,3	19	13,7	37	10
DS 05017	17	24,3	19	13,7	40	10
DS 05018	18	24,3	19	13,7	43	10
DS 05019	19	24,3	19	13,7	46	10
DS 05020	20	24,3	19	13,7	49	10
DS 05021	21	24,3	19	13,7	52	12
DS 05023	23	24,3	19	13,7	59	12
DS 05025	25	24,3	19	13,7	65	12

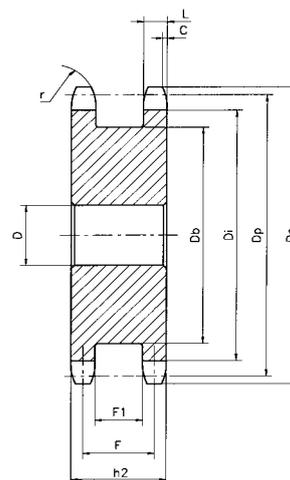

cod.	Z	1/2" x 5/16" - 08B R. 8,51				
		h <sub>2</sub>	F	F <sub>1</sub>	Db	D
DS 09012	12	31	23,8	16,6	33	10
DS 09013	13	31	23,8	16,6	37	10
DS 09014	14	31	23,8	16,6	42	10
DS 09015	15	31	23,8	16,6	45	10
DS 09016	16	31	23,8	16,6	49	10
DS 09017	17	31	23,8	16,6	53	12
DS 09018	18	31	23,8	16,6	57	12
DS 09019	19	31	23,8	16,6	62	12
DS 09020	20	31	23,8	16,6	66	12
DS 09021	21	31	23,8	16,6	70	14
DS 09023	23	31	23,8	16,6	78	14
DS 09024	24	31	23,8	16,6	82	14
DS 09025	25	31	23,8	16,6	86	14

cod.	Z	5/8" x 3/8" - 10B R. 10,16				
		h <sub>2</sub>	F	F <sub>1</sub>	Db	D
DS 10012	12	36,5	27,3	18,1	45	12
DS 10013	13	36,5	27,3	18,1	50	12
DS 10014	14	36,5	27,3	18,1	55	12
DS 10015	15	36,5	27,3	18,1	60	12
DS 10016	16	36,5	27,3	18,1	65	14
DS 10017	17	36,5	27,3	18,1	70	14
DS 10018	18	36,5	27,3	18,1	75	14
DS 10019	19	36,5	27,3	18,1	80	14
DS 10020	20	36,5	27,3	18,1	85	14
DS 10021	21	36,5	27,3	18,1	90	16
DS 10022	22	36,5	27,3	18,1	95	16
DS 10023	23	36,5	27,3	18,1	100	16
DS 10025	25	36,5	27,3	18,1	110	16

cod.	Z	3/4" x 7/16" - 12B R. 12,07				
		h <sub>2</sub>	F	F <sub>1</sub>	Db	D
DS 11012	12	45	33,9	22,8	53	14
DS 11013	13	45	33,9	22,8	59	14
DS 11014	14	45	33,9	22,8	65	14
DS 11015	15	45	33,9	22,8	71	14
DS 11016	16	45	33,9	22,8	77	14
DS 11017	17	45	33,9	22,8	83	16
DS 11018	18	45	33,9	22,8	89	16
DS 11019	19	45	33,9	22,8	95	16
DS 11020	20	45	33,9	22,8	101	16
DS 11021	21	45	33,9	22,8	107	20
DS 11023	23	45	33,9	22,8	119	20
DS 11025	25	45	33,9	22,8	131	20

cod.	Z	1" x 17,2 - 16B R. 15,88				
		h <sub>2</sub>	F	F <sub>1</sub>	Db	D
DS 12013	13	63,5	47,3	31,1	81	16
DS 12014	14	63,5	47,3	31,1	89	16
DS 12015	15	63,5	47,3	31,1	97	16
DS 12016	16	63,5	47,3	31,1	105	20
DS 12017	17	63,5	47,3	31,1	113	20
DS 12018	18	63,5	47,3	31,1	121	20
DS 12019	19	63,5	47,3	31,1	129	20
DS 12020	20	63,5	47,3	31,1	137	20
DS 12021	21	63,5	47,3	31,1	145	20
DS 12023	23	63,5	47,3	31,1	161	20
DS 12025	25	63,5	47,3	31,1	177	20



**Pignoni e corone ASA**  
**Sprockets and plate wheels ASA**  
**Kettenräder und Kettenradscheiben ASA**  
**Pignons et disques ASA**  
**Piñones y discos ASA**

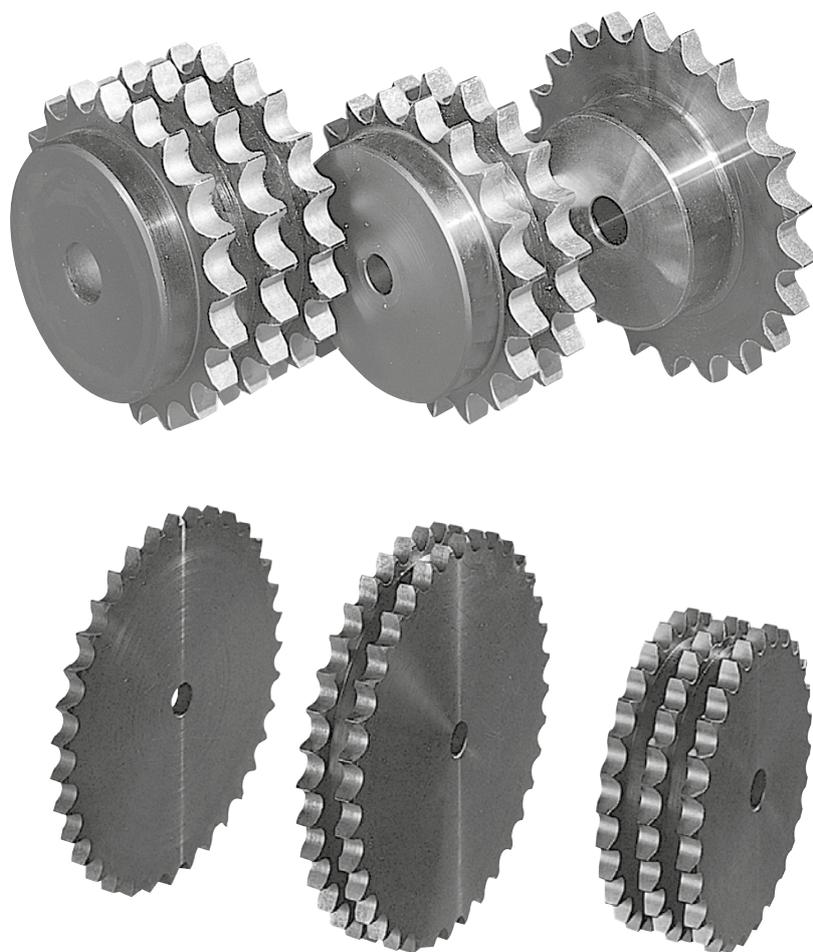

A richiesta possiamo eseguire dentature e passi nei profili ASA non indicati nel presente Catalogo in base a consuntivo.

On request, we can carry out tothing pitch on "ASA" profiles, not indicated in this catalogue, according to estimates.

Auf Wunsch können wir Zahnungen und Teilungen in den "ASA" Profilen ausführen, die in diesem Katalog nicht angegeben sind Preis nach Kostenvoranschlag.

Possibilité d'exécuter sur demande des dentures et des pas dans les profils "ASA" non indiqués dans le catalogue, sur devis.

Previa solicitud y en base a presupuesto podemos fabricar dentados y pasos con perfiles "ASA" no señalados en el presente catálogo.

Pignoni per catene semplici, doppie e triple a rulli secondo: DIN 8188 - ISO/R 606 - ANSI B 29,1

Sprockets for simplex, duplex and triplex chain to: DIN 8188 - ISO/R 606 - ANSI B 29,1

Kettenräder mit einseitiger Nabe für Simplex-Duplex-Triplex-Rollenkette nach: DIN 8188 - ISO/R 606 - ANSI B 29,1

Pignons avec moyeu déporté pour chaînes simples, doubles, et triples à rouleaux suivant les normes: DIN 8188 - ISO/R 606 - ANSI B 29,1

Piñones para cadena simple, doble y triple de rodillos según las normas: DIN 8188 - ISO/R 606 - ANSI B 29,1

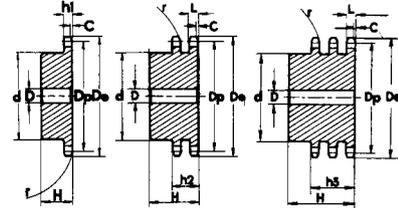

## 3/8" x 3/16"

## ASA 35 - 1-2-3 9,525 x 4,77 mm

CATENA	CHAIN	KETTE	CHAÎNE	CADENA	ASA 35
Passo	Pitch	Teilung	Pas	Paso	<b>9,525</b>
Larghezza interna	Internal width	Innere Breite	Largeur interieure	Ancho interno	<b>4,770</b>
Rullo ø	Roller ø	Rollen ø	ø du rouleau	Rodillo ø	<b>5,080</b>
PIGNONE	SPROCKETS	KETTENRÄDER	PIGNONS	PIÑONES	ASA 35
Raggio dente r	Tooth radius r	Radius r	Rayon de denture r	Radio diente r	<b>r 10,0</b>
Larghezza raggio C	Radius width C	Breite C	Largeur de rayon C	Ancho radio C	<b>C 1,2</b>
Largh. dente h <sub>1</sub>	Tooth width h <sub>1</sub>	Zahnbreite h <sub>1</sub>	Larg. de denture h <sub>1</sub>	Ancho diente h <sub>1</sub>	<b>h<sub>1</sub> 4,4</b>
Largh. dente L	Tooth width L	Zahnbreite L	Larg. de denture L	Ancho diente L	<b>L 4,3</b>
Largh. dente h <sub>2</sub>	Tooth width h <sub>2</sub>	Zahnbreite h <sub>2</sub>	Larg. de denture h <sub>2</sub>	Ancho diente h <sub>2</sub>	<b>h<sub>2</sub> 14,4</b>
Largh. dente h <sub>3</sub>	Tooth width h <sub>3</sub>	Zahnbreite h <sub>3</sub>	Larg. de denture h <sub>3</sub>	Ancho diente h <sub>3</sub>	<b>h<sub>3</sub> 24,5</b>
Altezza totale H	Full height H	Gesamt Höhe H	Hauteur totale H	Altura total H	<b>H -</b>

Materiale C 45 E  
UNI EN 10083-1

Material C 45 E  
UNI EN 10083-1

Werkstoff C 45 E  
UNI EN 10083-1

Matière C 45 E  
UNI EN 10083-1

Material C 45 E  
UNI EN 10083-1

Z	D <sub>e</sub>	D <sub>p</sub>	PS				PD			
			cod.	d	D	H	cod.	d	D	H
10	35,70	30,82	PS 05A10	20	8	22				
11	38,69	33,80	PS 05A11	22	8	25				
12	41,68	36,80	PS 05A12	25	8	25				
13	44,68	39,80	PS 05A13	28	10	25	PD 05A13	28	10	25
14	47,68	42,80	PS 05A14	31	10	25	PD 05A14	31	10	25
15	50,69	45,81	PS 05A15	34	10	25	PD 05A15	34	10	25
16	53,70	48,82	PS 05A16	38	10	28	PD 05A16	37	12	30
17	56,72	51,83	PS 05A17	38	10	28	PD 05A17	40	12	30
18	59,73	54,85	PS 05A18	38	10	28	PD 05A18	43	12	30
19	62,75	57,87	PS 05A19	46	10	28	PD 05A19	46	12	30
20	65,77	60,89	PS 05A20	46	10	28	PD 05A20	49	12	30
21	68,79	63,91	PS 05A21	46	10	28	PD 05A21	52	16	30
22	71,81	66,93	PS 05A22	52	12	28	PD 05A22	55	16	30
23	74,83	69,95	PS 05A23	52	12	28	PD 05A23	58	16	30
24	77,85	72,97	PS 05A24	52	12	28	PD 05A24	61	16	30
25	80,88	76,00	PS 05A25	58	12	28	PD 05A25	64	16	30
26	83,90	79,02	PS 05A26	58	12	28	PD 05A26	67	16	30
27	86,93	82,04	PS 05A27	58	12	28	PD 05A27	70	16	30
28	89,95	85,07	PS 05A28	60	12	28	PD 05A28	73	16	30
30	96,00	91,12	PS 05A30	60	12	28				

Pignoni per catene semplici, doppie e triple a rulli secondo: DIN 8188 - ISO/R 606 - ANSI B 29,1

Sprockets for simplex, duplex and triplex chain to: DIN 8188 - ISO/R 606 - ANSI B 29,1

Kettenräder mit einseitiger Nabe für Simplex-Duplex-Triplex-Rollenkette nach: DIN 8188 - ISO/R 606 - ANSI B 29,1

Pignons avec moyeu déporté pour chaînes simples, doubles, et triples à rouleaux suivant les normes: DIN 8188 - ISO/R 606 - ANSI B 29,1

Piñones para cadena simple, doble y triple de rodillos según las normas: DIN 8188 - ISO/R 606 - ANSI B 29,1

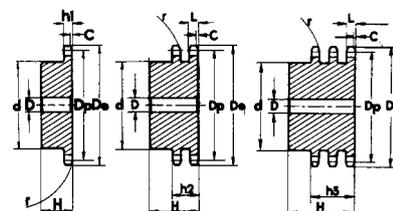

**1/2" x 5/16"**

**ASA 40 - 1-2-3 12,7 x 7,94 mm**

CATENA	CHAIN	KETTE	CHAÎNE	CADENA	ASA 40
Passo	Pitch	Teilung	Pas	Paso	12,7
Larghezza interna	Internal width	Innere Breite	Largeur interieure	Ancho interno	7,94
Rullo ø	Roller ø	Rollen ø	ø du rouleau	Rodillo ø	7,94

PIGNONE	SPROCKETS	KETTENRÄDER	PIGNONS	PIÑONES	ASA 40
Raggio dente r	Tooth radius r	Radius r	Rayon de denture r	Radio diente r	r 13,5
Larghezza raggio C	Radius width C	Breite C	Largeur de rayon C	Ancho radio C	C 1,6
Largh. dente h <sub>1</sub>	Tooth width h <sub>1</sub>	Zahnbreite h <sub>1</sub>	Larg. de denture h <sub>1</sub>	Ancho diente h <sub>1</sub>	h <sub>1</sub> 7,4
Largh. dente L	Tooth width L	Zahnbreite L	Larg. de denture L	Ancho diente L	L 7,2
Largh. dente h <sub>2</sub>	Tooth width h <sub>2</sub>	Zahnbreite h <sub>2</sub>	Larg. de denture h <sub>2</sub>	Ancho diente h <sub>2</sub>	h <sub>2</sub> 21,6
Largh. dente h <sub>3</sub>	Tooth width h <sub>3</sub>	Zahnbreite h <sub>3</sub>	Larg. de denture h <sub>3</sub>	Ancho diente h <sub>3</sub>	h <sub>3</sub> 36,0
Altezza totale H	Full height H	Gesamt Höhe H	Hauteur totale H	Altura total H	H -

**Materiale C 45 E**  
**UNI EN 10083-1**

**Material C 45 E**  
**UNI EN 10083-1**

**Werkstoff C 45 E**  
**UNI EN 10083-1**

**Matière C 45 E**  
**UNI EN 10083-1**

**Material C 45 E**  
**UNI EN 10083-1**

Z	D <sub>e</sub>	D <sub>p</sub>	PS			PD			PT					
			cod.	d	D	H	cod.	d	D	H	cod.	d	D	H
10	47,66	41,10	PS 09A10	26	10	25								
11	51,64	45,08	PS 09A11	29	10	25								
12	55,63	49,07	PS 09A12	35	10	28				PT 09A12	35	14	50	
13	59,63	53,07	PS 09A13	35	10	28	PD 09A13	38	12	35	PT 09A13	38	14	50
14	63,63	57,07	PS 09A14	35	10	28	PD 09A14	42	12	35	PT 09A14	42	14	50
15	67,64	61,08	PS 09A15	48	10	28	PD 09A15	46	12	35	PT 09A15	46	14	50
16	71,66	65,10	PS 09A16	48	10	28	PD 09A16	50	14	35	PT 09A16	50	16	50
17	75,68	69,12	PS 09A17	48	10	28	PD 09A17	54	14	35	PT 09A17	54	16	50
18	79,70	73,14	PS 09A18	60	12	28	PD 09A18	58	14	35	PT 09A18	58	16	50
19	83,72	77,16	PS 09A19	60	12	28	PD 09A19	62	14	35	PT 09A19	62	16	50
20	87,74	81,18	PS 09A20	60	12	28	PD 09A20	66	14	35	PT 09A20	66	16	50
21	91,77	85,21	PS 09A21	65	12	28	PD 09A21	70	16	40	PT 09A21	70	20	55
22	95,80	89,24	PS 09A22	65	12	28	PD 09A22	70	16	40	PT 09A22	70	20	55
23	99,83	93,27	PS 09A23	65	12	28	PD 09A23	70	16	40	PT 09A23	70	20	55
24	103,86	97,30	PS 09A24	70	14	28	PD 09A24	75	16	40	PT 09A24	75	20	55
25	107,89	101,33	PS 09A25	70	14	28	PD 09A25	80	16	40	PT 09A25	80	20	55
26	111,92	105,36	PS 09A26	70	14	28	PD 09A26	85	20	40	PT 09A26	85	20	55
27	115,96	109,40	PS 09A27	70	16	30	PD 09A27	85	20	40	PT 09A27	85	20	55
28	119,99	113,43	PS 09A28	70	16	30	PD 09A28	90	20	40	PT 09A28	90	20	55
30	128,06	121,50	PS 09A30	80	16	30	PD 09A30	100	20	40				
32	136,13	129,57	PS 09A32	80	16	30								
35	148,24	141,68	PS 09A35	90	16	30								
36	152,28	145,72	PS 09A36	90	16	30								
38	160,35	153,79	PS 09A38	90	16	35								
40	168,43	161,87	PS 09A40	90	16	35								





Pignoni per catene semplici, doppie e triple a rulli secondo: DIN 8188 - ISO/R 606 - ANSI B 29,1

Sprockets for simplex, duplex and triplex chain to: DIN 8188 - ISO/R 606 - ANSI B 29,1

Kettenräder mit einseitiger Nabe für Simplex-Duplex-Triplex-Rollenkette nach: DIN 8188 - ISO/R 606 - ANSI B 29,1

Pignons avec moyeu déporté pour chaînes simples, doubles, et triples à rouleaux suivant les normes: DIN 8188 - ISO/R 606 - ANSI B 29,1

Piñones para cadena simple, doble y triple de rodillos según las normas: DIN 8188 - ISO/R 606 - ANSI B 29,1

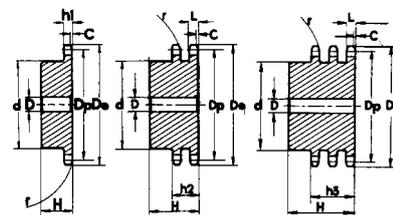

**3/4" x 1/2"**

**ASA 60 - 1-2-3 19,05 x 12,7 mm**

CATENA	CHAIN	KETTE	CHAÎNE	CADENA	ASA 60
Passo	Pitch	Teilung	Pas	Paso	<b>19,05</b>
Larghezza interna	Internal width	Innere Breite	Largeur interieure	Ancho interno	<b>12,70</b>
Rullo ø	Roller ø	Rollen ø	ø du rouleau	Rodillo ø	<b>11,91</b>

PIGNONE	SPROCKETS	KETTENRÄDER	PIGNONS	PIÑONES	ASA 60
Raggio dente r	Tooth radius r	Radius r	Rayon de denture r	Radio diente r	<b>r 20,0</b>
Larghezza raggio C	Radius width C	Breite C	Largeur de rayon C	Ancho radio C	<b>C 2,4</b>
Largh. dente h <sub>1</sub>	Tooth width h <sub>1</sub>	Zahnbreite h <sub>1</sub>	Larg. de denture h <sub>1</sub>	Ancho diente h <sub>1</sub>	<b>h<sub>1</sub> 12,0</b>
Largh. dente L	Tooth width L	Zahnbreite L	Larg. de denture L	Ancho diente L	<b>L 11,8</b>
Largh. dente h <sub>2</sub>	Tooth width h <sub>2</sub>	Zahnbreite h <sub>2</sub>	Larg. de denture h <sub>2</sub>	Ancho diente h <sub>2</sub>	<b>h<sub>2</sub> 34,6</b>
Largh. dente h <sub>3</sub>	Tooth width h <sub>3</sub>	Zahnbreite h <sub>3</sub>	Larg. de denture h <sub>3</sub>	Ancho diente h <sub>3</sub>	<b>h<sub>3</sub> 57,4</b>
Altezza totale H	Full height H	Gesamt Höhe H	Hauteur totale H	Altura total H	<b>H -</b>

Materiale C 45 E UNI EN 10083-1			Material C 45 E UNI EN 10083-1			Werkstoff C 45 E UNI EN 10083-1			Matière C 45 E UNI EN 10083-1			Material C 45 E UNI EN 10083-1		
Z	D <sub>e</sub>	D <sub>p</sub>	PS			PD			PT					
			cod.	d	D	H	cod.	d	D	H	cod.	d	D	H
10	71,54	61,64	PS 11A10	42	12	30	PD 11A10	42	12	45				
11	77,51	67,61	PS 11A11	45	12	30	PD 11A11	47	16	50				
12	83,49	73,61	PS 11A12	45	12	30	PD 11A12	53	16	50	PT 11A12	53	20	70
13	89,49	79,59	PS 11A13	60	14	35	PD 11A13	59	16	50	PT 11A13	59	20	70
14	95,50	85,61	PS 11A14	60	14	35	PD 11A14	65	16	50	PT 11A14	65	20	70
15	101,52	91,63	PS 11A15	60	14	35	PD 11A15	71	16	50	PT 11A15	71	20	70
16	107,54	97,65	PS 11A16	75	16	35	PD 11A16	77	20	50	PT 11A16	77	20	70
17	113,56	103,67	PS 11A17	75	16	35	PD 11A17	83	20	50	PT 11A17	83	20	70
18	119,59	109,71	PS 11A18	75	16	35	PD 11A18	89	20	50	PT 11A18	89	20	70
19	125,63	115,75	PS 11A19	80	16	35	PD 11A19	95	20	50	PT 11A19	95	20	70
20	131,67	121,78	PS 11A20	80	16	35	PD 11A20	100	20	50	PT 11A20	100	20	70
21	137,71	127,82	PS 11A21	80	16	35	PD 11A21	100	20	50	PT 11A21	100	20	70
22	143,75	133,86	PS 11A22	90	20	40	PD 11A22	100	20	50	PT 11A22	100	20	70
23	149,79	139,90	PS 11A23	90	20	40	PD 11A23	110	20	50	PT 11A23	110	20	70
24	155,84	145,94	PS 11A24	90	20	40	PD 11A24	110	20	50	PT 11A24	110	20	70
25	161,88	152,00	PS 11A25	90	20	40	PD 11A25	120	20	50	PT 11A25	120	20	70
26	167,93	158,04	PS 11A26	90	20	40	PD 11A26	120	20	50				
27	173,98	164,09	PS 11A27	90	20	40	PD 11A27	120	20	50				
28	180,03	170,13	PS 11A28	95	20	40	PD 11A28	120	20	50				
30	192,14	182,25	PS 11A30	95	20	40	PD 11A30	120	20	50				

Pignoni per catene semplici, doppie e triple a rulli secondo: DIN 8188 - ISO/R 606 - ANSI B 29,1

Sprockets for simplex, duplex and triplex chain to: DIN 8188 - ISO/R 606 - ANSI B 29,1

Kettenräder mit einseitiger Nabe für Simplex-Duplex-Triplex-Rollenkette nach: DIN 8188 - ISO/R 606 - ANSI B 29,1

Pignons avec moyeu déporté pour chaînes simples, doubles, et triples à rouleaux suivant les normes: DIN 8188 - ISO/R 606 - ANSI B 29,1

Piñones para cadena simple, doble y triple de rodillos según las normas: DIN 8188 - ISO/R 606 - ANSI B 29,1

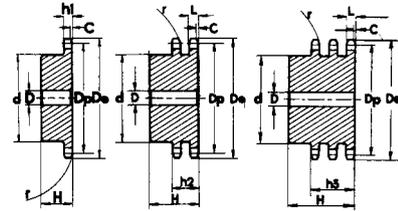

1" x 5/8"

ASA 80 - 1-2-3 25,4 x 15,88 mm

CATENA	CHAIN	KETTE	CHAÎNE	CADENA	ASA 80
Passo	Pitch	Teilung	Pas	Paso	25,40
Larghezza interna	Internal width	Innere Breite	Largeur interieure	Ancho interno	15,88
Rullo $\varnothing$	Roller $\varnothing$	Rollen $\varnothing$	$\varnothing$ du rouleau	Rodillo $\varnothing$	15,88
PIGNONE	SPROCKETS	KETTENRÄDER	PIGNONS	PIÑONES	ASA 80
Raggio dente r	Tooth radius r	Radius r	Rayon de denture r	Radio diente r	r 27,0
Larghezza raggio C	Radius width C	Breite C	Largeur de rayon C	Ancho radio C	C 3,2
Largh. dente $h_1$	Tooth width $h_1$	Zahnbreite $h_1$	Larg. de denture $h_1$	Ancho diente $h_1$	$h_1$ 15,0
Largh. dente L	Tooth width L	Zahnbreite L	Larg. de denture L	Ancho diente L	L 14,7
Largh. dente $h_2$	Tooth width $h_2$	Zahnbreite $h_2$	Larg. de denture $h_2$	Ancho diente $h_2$	$h_2$ 44,0
Largh. dente $h_3$	Tooth width $h_3$	Zahnbreite $h_3$	Larg. de denture $h_3$	Ancho diente $h_3$	$h_3$ 73,3
Altezza totale H	Full height H	Gesamt Höhe H	Hauteur totale H	Altura total H	H -

Materiale C 45 E  
UNI EN 10083-1

Material C 45 E  
UNI EN 10083-1

Werkstoff C 45 E  
UNI EN 10083-1

Matière C 45 E  
UNI EN 10083-1

Material C 45 E  
UNI EN 10083-1

Z	$D_e$	$D_p$	PS				PD				PT				
			cod.	d	D	H	cod.	d	D	H	cod.	d	D	H	
8	79,49	66,37	PS 12A08	42	16	35									
9	87,38	74,27	PS 12A09	50	16	35									
10	95,32	82,19	PS 12A10	55	16	35									
11	103,28	90,14	PS 12A11	61	16	40									
12	111,26	98,14	PS 12A12	69	16	40	PD 12A12	72	20	70	PT 12A12	72	25	100	
13	119,26	106,12	PS 12A13	78	16	40	PD 12A13	80	20	70	PT 12A13	80	25	100	
14	127,27	114,15	PS 12A14	84	16	40	PD 12A14	88	20	70	PT 12A14	88	25	100	
15	135,29	122,17	PS 12A15	92	16	40	PD 12A15	96	20	70	PT 12A15	96	25	100	
16	143,32	130,20	PS 12A16	100	20	45	PD 12A16	104	20	70	PT 12A16	104	30	100	
17	151,35	138,22	PS 12A17	100	20	45	PD 12A17	112	20	70	PT 12A17	112	30	100	
18	159,39	146,28	PS 12A18	100	20	45	PD 12A18	120	20	70	PT 12A18	120	30	100	
19	167,44	154,33	PS 12A19	100	20	45	PD 12A19	128	20	70	PT 12A19	128	30	100	
20	175,49	162,38	PS 12A20	100	20	45	PD 12A20	130	20	70	PT 12A20	130	30	100	
21	183,54	170,43	PS 12A21	110	20	50	PD 12A21	130	25	70					
22	191,60	178,48	PS 12A22	110	20	50									
23	199,66	186,53	PS 12A23	110	20	50									
24	207,72	194,59	PS 12A24	110	20	50									
25	215,78	202,66	PS 12A25	110	20	50									
26	223,84	210,72	PS 12A26	120	20	50									
27	231,91	218,79	PS 12A27	120	20	50									
28	239,98	226,85	PS 12A28	120	20	50									
29	248,05	234,92	PS 12A29	120	20	50									
30	256,12	243,00	PS 12A30	120	20	50									

Pignoni per catene semplici, doppie e triple a rulli secondo: DIN 8188 - ISO/R 606 - ANSI B 29,1

Sprockets for simplex, duplex and triplex chain to: DIN 8188 - ISO/R 606 - ANSI B 29,1

Kettenräder mit einseitiger Nabe für Simplex-Duplex-Triplex-Rollenkette nach: DIN 8188 - ISO/R 606 - ANSI B 29,1

Pignons avec moyeu déporté pour chaînes simples, doubles, et triples à rouleaux suivant les normes: DIN 8188 - ISO/R 606 - ANSI B 29,1

Piñones para cadena simple, doble y triple de rodillos según las normas: DIN 8188 - ISO/R 606 - ANSI B 29,1

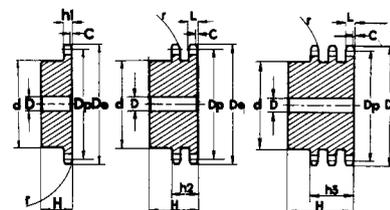

**1"1/4 x 3/4"**

**ASA 100 - 1-2-3 31,75 x 19,05 mm**

CATENA	CHAIN	KETTE	CHAÎNE	CADENA	ASA 100
Passo	Pitch	Teilung	Pas	Paso	<b>31,75</b>
Larghezza interna	Internal width	Innere Breite	Largeur interieure	Ancho interno	<b>19,05</b>
Rullo $\varnothing$	Roller $\varnothing$	Rollen $\varnothing$	$\varnothing$ du rouleau	Rodillo $\varnothing$	<b>19,05</b>

PIGNONE	SPROCKETS	KETTENRÄDER	PIGNONS	PIÑONES	ASA 100
Raggio dente r	Tooth radius r	Radius r	Rayon de denture r	Radio diente r	<b>r 33,5</b>
Larghezza raggio C	Radius width C	Breite C	Largeur de rayon C	Ancho radio C	<b>C 4,0</b>
Largh. dente $h_1$	Tooth width $h_1$	Zahnbreite $h_1$	Larg. de denture $h_1$	Ancho diente $h_1$	<b><math>h_1</math> 18,0</b>
Largh. dente L	Tooth width L	Zahnbreite L	Larg. de denture L	Ancho diente L	<b>L 17,7</b>
Largh. dente $h_2$	Tooth width $h_2$	Zahnbreite $h_2$	Larg. de denture $h_2$	Ancho diente $h_2$	<b><math>h_2</math> 53,5</b>
Largh. dente $h_3$	Tooth width $h_3$	Zahnbreite $h_3$	Larg. de denture $h_3$	Ancho diente $h_3$	<b><math>h_3</math> 89,2</b>
Altezza totale H	Full height H	Gesamt Höhe H	Hauteur totale H	Altura total H	<b>H -</b>

**Materiale C 45 E**  
**UNI EN 10083-1**

**Material C 45 E**  
**UNI EN 10083-1**

**Werkstoff C 45 E**  
**UNI EN 10083-1**

**Matière C 45 E**  
**UNI EN 10083-1**

**Material C 45 E**  
**UNI EN 10083-1**

Z	$D_e$	$D_p$	PS				PD			
			cod.	d	D	H	cod.	d	D	H
8	98,1	82,96	PS 13A08	53	20	40				
9	108,0	92,84	PS 13A09	63	20	40				
10	117,9	102,74	PS 13A10	70	20	40				
11	127,8	112,68	PS 13A11	77	20	45				
12	137,8	122,68	PS 13A12	88	20	45	PD 13A12	90	20	80
13	147,8	132,65	PS 13A13	98	20	45	PD 13A13	100	20	80
14	157,8	142,68	PS 13A14	108	20	45	PD 13A14	110	20	80
15	167,9	152,72	PS 13A15	118	20	45	PD 13A15	120	20	80
16	177,9	162,75	PS 13A16	120	25	50	PD 13A16	120	25	80
17	187,9	172,78	PS 13A17	120	25	50	PD 13A17	120	25	80
18	198,0	182,85	PS 13A18	120	25	50				
19	208,1	192,91	PS 13A19	120	25	50				
20	218,1	202,98	PS 13A20	120	25	50				
21	228,2	213,04	PS 13A21	140	25	55				
22	238,3	223,11	PS 13A22	140	25	55				
23	248,3	233,17	PS 13A23	140	25	55				
24	258,4	243,23	PS 13A24	140	25	55				
25	268,5	253,33	PS 13A25	140	25	55				

Pignoni per catene semplici, doppie e triple a rulli secondo: DIN 8188 - ISO/R 606 - ANSI B 29,1

Sprockets for simplex, duplex and triplex chain to: DIN 8188 - ISO/R 606 - ANSI B 29,1

Kettenräder mit einseitiger Nabe für Simplex-Duplex-Triplex-Rollenkette nach: DIN 8188 - ISO/R 606 - ANSI B 29,1

Pignons avec moyeu déporté pour chaînes simples, doubles, et triples à rouleaux suivant les normes: DIN 8188 - ISO/R 606 - ANSI B 29,1

Piñones para cadena simple, doble y triple de rodillos según las normas: DIN 8188 - ISO/R 606 - ANSI B 29,1

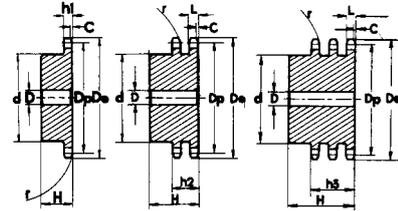

## 1"1/2 x 1"

## ASA 120 - 1-2-3 38,1 x 25,4 mm

CATENA	CHAIN	KETTE	CHAÎNE	CADENA	ASA 120
Passo	Pitch	Teilung	Pas	Paso	<b>38,10</b>
Larghezza interna	Internal width	Innere Breite	Largeur interieure	Ancho interno	<b>25,40</b>
Rullo ø	Roller ø	Rollen ø	ø du rouleau	Rodillo ø	<b>22,22</b>
PIGNONE	SPROCKETS	KETTENRÄDER	PIGNONS	PIÑONES	ASA 120
Raggio dente r	Tooth radius r	Radius r	Rayon de denture r	Radio diente r	<b>r 40,5</b>
Larghezza raggio C	Radius width C	Breite C	Largeur de rayon C	Ancho radio C	<b>C 4,8</b>
Largh. dente h <sub>1</sub>	Tooth width h <sub>1</sub>	Zahnbreite h <sub>1</sub>	Larg. de denture h <sub>1</sub>	Ancho diente h <sub>1</sub>	<b>h<sub>1</sub> 24,1</b>
Largh. dente L	Tooth width L	Zahnbreite L	Larg. de denture L	Ancho diente L	<b>L 23,6</b>
Largh. dente h <sub>2</sub>	Tooth width h <sub>2</sub>	Zahnbreite h <sub>2</sub>	Larg. de denture h <sub>2</sub>	Ancho diente h <sub>2</sub>	<b>h<sub>2</sub> 69,0</b>
Largh. dente h <sub>3</sub>	Tooth width h <sub>3</sub>	Zahnbreite h <sub>3</sub>	Larg. de denture h <sub>3</sub>	Ancho diente h <sub>3</sub>	<b>h<sub>3</sub> 114,5</b>
Altezza totale H	Full height H	Gesamt Höhe H	Hauteur totale H	Altura total H	<b>H -</b>

Materiale C 45 E  
UNI EN 10083-1

Material C 45 E  
UNI EN 10083-1

Werkstoff C 45 E  
UNI EN 10083-1

Matière C 45 E  
UNI EN 10083-1

Material C 45 E  
UNI EN 10083-1

Z	D <sub>e</sub>	D <sub>p</sub>	PS				PD			
			cod.	d	D	H	cod.	d	D	H
8	119,04	99,55	PS 14A08	58	20	45				
9	130,88	111,40	PS 14A09	70	20	45				
10	142,77	123,29	PS 14A10	80	20	45				
11	154,71	135,21	PS 14A11	90	25	50				
12	166,69	147,22	PS 14A12	102	25	50	PD 14A12	102	25	100
13	178,68	159,18	PS 14A13	114	25	50	PD 14A13	114	25	100
14	190,70	171,22	PS 14A14	128	25	50	PD 14A14	128	25	100
15	202,73	183,26	PS 14A15	140	25	50	PD 14A15	140	25	100

## 1"3/4 x 1"1/4

## ASA 140 - 1-2-3 44,45 x 25,4 mm

CATENA	CHAIN	KETTE	CHAÎNE	CADENA	ASA 140
Passo	Pitch	Teilung	Pas	Paso	<b>44,45</b>
Larghezza interna	Internal width	Innere Breite	Largeur interieure	Ancho interno	<b>25,40</b>
Rullo ø	Roller ø	Rollen ø	ø du rouleau	Rodillo ø	<b>25,40</b>
PIGNONE	SPROCKETS	KETTENRÄDER	PIGNONS	PIÑONES	ASA 140
Raggio dente r	Tooth radius r	Radius r	Rayon de denture r	Radio diente r	<b>r 47,5</b>
Larghezza raggio C	Radius width C	Breite C	Largeur de rayon C	Ancho radio C	<b>C 5,8</b>
Largh. dente h <sub>1</sub>	Tooth width h <sub>1</sub>	Zahnbreite h <sub>1</sub>	Larg. de denture h <sub>1</sub>	Ancho diente h <sub>1</sub>	<b>h<sub>1</sub> 24,1</b>
Largh. dente L	Tooth width L	Zahnbreite L	Larg. de denture L	Ancho diente L	<b>L 23,6</b>
Largh. dente h <sub>2</sub>	Tooth width h <sub>2</sub>	Zahnbreite h <sub>2</sub>	Larg. de denture h <sub>2</sub>	Ancho diente h <sub>2</sub>	<b>h<sub>2</sub> 72,5</b>
Largh. dente h <sub>3</sub>	Tooth width h <sub>3</sub>	Zahnbreite h <sub>3</sub>	Larg. de denture h <sub>3</sub>	Ancho diente h <sub>3</sub>	<b>h<sub>3</sub> 121,3</b>
Altezza totale H	Full height H	Gesamt Höhe H	Hauteur totale H	Altura total H	<b>H -</b>

## 2" x 1"1/4

## ASA 160 - 1-2-3 50,8 x 31,75 mm

CATENA	CHAIN	KETTE	CHAÎNE	CADENA	ASA 160
Passo	Pitch	Teilung	Pas	Paso	<b>50,80</b>
Larghezza interna	Internal width	Innere Breite	Largeur interieure	Ancho interno	<b>31,75</b>
Rullo ø	Roller ø	Rollen ø	ø du rouleau	Rodillo ø	<b>28,58</b>
PIGNONE	SPROCKETS	KETTENRÄDER	PIGNONS	PIÑONES	ASA 160
Raggio dente r	Tooth radius r	Radius r	Rayon de denture r	Radio diente r	<b>r 54,0</b>
Larghezza raggio C	Radius width C	Breite C	Largeur de rayon C	Ancho radio C	<b>C 7,0</b>
Largh. dente h <sub>1</sub>	Tooth width h <sub>1</sub>	Zahnbreite h <sub>1</sub>	Larg. de denture h <sub>1</sub>	Ancho diente h <sub>1</sub>	<b>h<sub>1</sub> 30,1</b>
Largh. dente L	Tooth width L	Zahnbreite L	Larg. de denture L	Ancho diente L	<b>L 29,5</b>
Largh. dente h <sub>2</sub>	Tooth width h <sub>2</sub>	Zahnbreite h <sub>2</sub>	Larg. de denture h <sub>2</sub>	Ancho diente h <sub>2</sub>	<b>h<sub>2</sub> 88,0</b>
Largh. dente h <sub>3</sub>	Tooth width h <sub>3</sub>	Zahnbreite h <sub>3</sub>	Larg. de denture h <sub>3</sub>	Ancho diente h <sub>3</sub>	<b>h<sub>3</sub> 146,6</b>
Altezza totale H	Full height H	Gesamt Höhe H	Hauteur totale H	Altura total H	<b>H -</b>

# Corone / Plate wheels Kettenradscheiben / Disques / Discos



Corone per catene semplici, doppie e triple a rulli secondo: DIN 8188 - ISO/R 606 - ANSI B 29,1  
**Corone tornite sui lati, dentate con creatore.**

Plate wheels for simplex, duplex and triplex chain to: DIN 8188 - ISO/R 606 - ANSI B 29,1  
**Plate Wheels turned on both sides and toothed by milling cutter.**

Kettenradscheiben mit einseitiger Nabe für Simplex- Duplex- Triplex-Rollenkette nach: DIN 8188 - ISO/R 606 - ANSI B 29,1  
**Seitlich plan gedrehte, wälzgefräste Zahnkränze.**

Disques avec moyeu déporté pour chaînes simples, doubles et triples à rouleaux suivant les normes: DIN 8188 - ISO/R 606 - ANSI B 29,1  
**Disques tournés sur les flancs, dentés à la fraise.**

Discos para cadena simple, doble y triple de rodillos segun: DIN 8188 - ISO/R 606 - ANSI B 29,1  
**Discos torneadas en los lados, dientes obtenidos con fresa madre.**

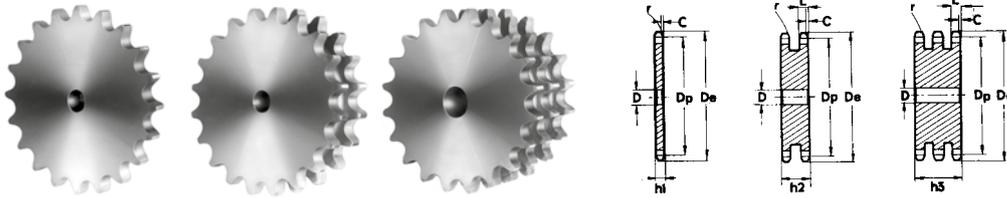

## 3/8" x 3/16"

## ASA 35 - 1-2-3 9,525 x 4,77 mm

CATENA:	CHAIN:	KETTE:	CHAÎNE:	CADENA:	ASA 35
Passo	Pitch	Teilung	Pas	Paso	<b>9,525</b>
Larghezza interna	Internal width	Innere Breite	Largeur interieure	Ancho interno	<b>4,770</b>
Rullo ø	Roller ø	Rollen ø	ø du rouleau	Rodillo ø	<b>5,080</b>

CORONE	PLATE WHEELS	KETTENRADSCHIEBEN	DISQUES	DISCOS	ASA 35
Raggio dente r	Tooth radius r	Radius r	Rayon de denture r	Radio diente r	<b>r 10,0</b>
Larghezza raggio C	Radius width C	Breite C	Largeur de rayon C	Ancho radio C	<b>C 1,2</b>
Largh. dente h <sub>1</sub>	Tooth width h <sub>1</sub>	Zahnbreite h <sub>1</sub>	Larg. de denture h <sub>1</sub>	Ancho diente h <sub>1</sub>	<b>h<sub>1</sub> 4,4</b>
Largh. dente L	Tooth width L	Zahnbreite L	Larg. de denture L	Ancho diente L	<b>L 4,3</b>
Largh. dente h <sub>2</sub>	Tooth width h <sub>2</sub>	Zahnbreite h <sub>2</sub>	Larg. de denture h <sub>2</sub>	Ancho diente h <sub>2</sub>	<b>h<sub>2</sub> 14,4</b>
Largh. dente h <sub>3</sub>	Tooth width h <sub>3</sub>	Zahnbreite h <sub>3</sub>	Larg. de denture h <sub>3</sub>	Ancho diente h <sub>3</sub>	<b>h<sub>3</sub> 24,5</b>
Altezza totale H	Full height H	Gesamt Höhe H	Hauteur totale H	Altura total H	<b>H -</b>

Z	D <sub>e</sub>	D <sub>p</sub>	CS		CD	
			cod.	d	cod.	d
30	96,00	91,12			CD 05A30	12
32	102,06	97,17	CS 05A32	12		
36	114,17	109,29	CS 05A36	12		
38	120,22	115,34	CS 05A38	12	CD 05A38	14
40	126,28	121,40	CS 05A40	12		
45	141,43	136,55	CS 05A45	16	CD 05A45	16
48	150,52	145,64	CS 05A48	16		
57	177,79	172,91	CS 05A57	16	CD 05A57	16
76	235,37	230,49	CS 05A76	20	CD 05A76	20

## 1/2" x 5/16"

## ASA 40 - 1-2-3 12,7 x 7,94 mm

CATENA:	CHAIN:	KETTE:	CHAÎNE:	CADENA:	ASA 40
Passo	Pitch	Teilung	Pas	Paso	<b>12,70</b>
Larghezza interna	Internal width	Innere Breite	Largeur interieure	Ancho interno	<b>7,94</b>
Rullo ø	Roller ø	Rollen ø	ø du rouleau	Rodillo ø	<b>7,94</b>

CORONE	PLATE WHEELS	KETTENRADSCHIEBEN	DISQUES	DISCOS	ASA 40
Raggio dente r	Tooth radius r	Radius r	Rayon de denture r	Radio diente r	<b>r 13,5</b>
Larghezza raggio C	Radius width C	Breite C	Largeur de rayon C	Ancho radio C	<b>C 1,6</b>
Largh. dente h <sub>1</sub>	Tooth width h <sub>1</sub>	Zahnbreite h <sub>1</sub>	Larg. de denture h <sub>1</sub>	Ancho diente h <sub>1</sub>	<b>h<sub>1</sub> 7,4</b>
Largh. dente L	Tooth width L	Zahnbreite L	Larg. de denture L	Ancho diente L	<b>L 7,2</b>
Largh. dente h <sub>2</sub>	Tooth width h <sub>2</sub>	Zahnbreite h <sub>2</sub>	Larg. de denture h <sub>2</sub>	Ancho diente h <sub>2</sub>	<b>h<sub>2</sub> 21,6</b>
Largh. dente h <sub>3</sub>	Tooth width h <sub>3</sub>	Zahnbreite h <sub>3</sub>	Larg. de denture h <sub>3</sub>	Ancho diente h <sub>3</sub>	<b>h<sub>3</sub> 36,0</b>
Altezza totale H	Full height H	Gesamt Höhe H	Hauteur totale H	Altura total H	<b>H -</b>

Z	D <sub>e</sub>	D <sub>p</sub>	CS		CD		CT	
			cod.	d	cod.	d	cod.	d
30	128,06	121,50					CT 09A30	20
32	136,13	129,57			CD 09A32	16		
38	160,35	153,79			CD 09A38	20	CT 09A38	25
40	168,43	161,87			CD 09A40	20		
42	176,50	169,94	CS 09A42	20				
45	188,62	182,06	CS 09A45	20	CD 09A45	20	CT 09A45	25
48	200,74	194,18	CS 09A48	20				
57	237,10	230,54	CS 09A57	20	CD 09A57	25	CT 09A57	25
76	313,88	307,32	CS 09A76	25	CD 09A76	25	CT 09A76	25
95	390,67	384,11			CD 09A95	25		

Corone per catene semplici, doppie e triple a rulli secondo: DIN 8188 - ISO/R 606 - ANSI B 29,1  
**Corone tornite sui lati, dentate con creatore.**

Plate wheels for simplex, duplex and triplex chain to: DIN 8188 - ISO/R 606 - ANSI B 29,1  
**Plate Wheels turned on both sides and toothed by milling cutter.**

Kettenradscheiben mit einseitiger Nabe für Simplex- Duplex- Triplex-Rollenkette nach: DIN 8188 - ISO/R 606 - ANSI B 29,1  
**Seitlich plan gedrehte, wälzgefräste Zahnkränze.**

Disques avec moyeu déporté pour chaînes simples, doubles et triples à rouleaux suivant les normes: DIN 8188 - ISO/R 606 - ANSI B 29,1  
**Disques tournés sur les flancs, dentés à la fraise.**

Discos para cadena simple, doble y triple de rodillos segun: DIN 8188 - ISO/R 606 - ANSI B 29,1  
**Discos torneadas en los lados, dientes obtenidos con fresa madre.**



**5/8" x 3/8"**

**ASA 50 - 1-2-3 15,875 x 9,52 mm**

CATENA:	CHAIN:	KETTE:	CHAÎNE:	CADENA:		<b>ASA 50</b>
Passo	Pitch	Teilung	Pas	Paso		<b>15,875</b>
Larghezza interna	Internal width	Innere Breite	Largeur interieure	Ancho interno		<b>9,520</b>
Rullo ø	Roller ø	Rollen ø	ø du rouleau	Rodillo ø		<b>10,160</b>

CORONE	PLATE WHEELS	KETTENRADSCHIEBEN	DISQUES	DISCOS		<b>ASA 50</b>
Raggio dente r	Tooth radius r	Radius r	Rayon de denture r	Radio diente r	<b>r</b>	<b>17,0</b>
Larghezza raggio C	Radius width C	Breite C	Largeur de rayon C	Ancho radio C	<b>C</b>	<b>2,0</b>
Largh. dente h <sub>1</sub>	Tooth width h <sub>1</sub>	Zahnbreite h <sub>1</sub>	Larg. de denture h <sub>1</sub>	Ancho diente h <sub>1</sub>	<b>h<sub>1</sub></b>	<b>9,0</b>
Largh. dente L	Tooth width L	Zahnbreite L	Larg. de denture L	Ancho diente L	<b>L</b>	<b>8,8</b>
Largh. dente h <sub>2</sub>	Tooth width h <sub>2</sub>	Zahnbreite h <sub>2</sub>	Larg. de denture h <sub>2</sub>	Ancho diente h <sub>2</sub>	<b>h<sub>2</sub></b>	<b>26,9</b>
Largh. dente h <sub>3</sub>	Tooth width h <sub>3</sub>	Zahnbreite h <sub>3</sub>	Larg. de denture h <sub>3</sub>	Ancho diente h <sub>3</sub>	<b>h<sub>3</sub></b>	<b>45,0</b>
Altezza totale H	Full height H	Gesamt Höhe H	Hauteur totale H	Altura total H	<b>H</b>	<b>-</b>

Z	D <sub>e</sub>	D <sub>p</sub>	CS		CD		CT	
			cod.	D	cod.	D	cod.	D
8	47,0	41,48	CS 10A08	10				
9	52,6	46,42	CS 10A09	10				
10	57,5	51,37	CS 10A10	10				
11	63,0	56,34	CS 10A11	10				
12	68,0	61,34	CS 10A12	10				
13	73,0	66,32	CS 10A13	10				
14	78,0	71,34	CS 10A14	10				
15	83,0	76,36	CS 10A15	10				
16	88,0	81,37	CS 10A16	12				
17	93,0	86,38	CS 10A17	12				
18	98,3	91,42	CS 10A18	12				
19	103,3	96,45	CS 10A19	12				
20	108,4	101,49	CS 10A20	12				
21	113,4	106,52	CS 10A21	12				
22	118,0	111,55	CS 10A22	12				
23	123,5	116,58	CS 10A23	12				
24	128,3	121,62	CS 10A24	12				
25	134,0	126,66	CS 10A25	12				
26	139,0	131,70	CS 10A26	16				
27	144,0	136,75	CS 10A27	16				
28	148,7	141,78	CS 10A28	16				
29	153,8	146,83	CS 10A29	16				
30	158,8	151,87	CS 10A30	16	CD 10A30	20	CT 10A30	20
31	163,9	156,92	CS 10A31	16				
32	168,9	161,95	CS 10A32	16				
33	174,5	167,00	CS 10A33	16				
34	179,0	172,05	CS 10A34	16				
35	184,1	177,10	CS 10A35	20				
36	189,1	182,15	CS 10A36	20				
37	194,2	187,20	CS 10A37	20				
38	199,2	192,24	CS 10A38	20	CD 10A38	20	CT 10A38	25
39	204,2	197,29	CS 10A39	20				
40	209,3	202,34	CS 10A40	20				
41	214,8	207,39	CS 10A41	20				
42	219,9	212,44	CS 10A42	20				
43	224,9	217,49	CS 10A43	20				
44	230,0	222,53	CS 10A44	20				
45	235,0	227,58	CS 10A45	20	CD 10A45	20	CT 10A45	25
46	240,1	232,63	CS 10A46	20				
47	245,1	237,68	CS 10A47	20				
48	250,2	242,73	CS 10A48	20				
49	255,2	247,78	CS 10A49	20				
50	260,3	252,82	CS 10A50	20				
51	265,3	257,87	CS 10A51	20				
52	270,4	262,92	CS 10A52	20				
53	275,4	267,97	CS 10A53	20				
54	280,5	273,03	CS 10A54	20				
55	285,5	278,08	CS 10A55	20				
56	296,0	283,13	CS 10A56	25				
57	290,6	288,18	CS 10A57	25	CD 10A57	25	CT 10A57	25
58	300,7	293,23	CS 10A58	25				
59	305,7	298,27	CS 10A59	25				
60	310,8	303,32	CS 10A60	25				
62	321,4	313,43	CS 10A62	25				
64	331,5	321,53	CS 10A64	25				
65	336,5	328,58	CS 10A65	25				
66	341,6	333,63	CS 10A66	25				
68	351,7	343,74	CS 10A68	25				
70	361,8	353,84	CS 10A70	25				
72	371,9	363,95	CS 10A72	25				
75	387,1	379,09	CS 10A75	25				
76	392,1	384,16	CS 10A76	25	CD 10A76	25	CT 10A76	30
78	402,2	394,25	CS 10A78	25				
80	412,3	404,35	CS 10A80	30				
85	437,6	429,62	CS 10A85	30				
90	462,8	454,88	CS 10A90	30				
95	488,5	480,14	CS 10A95	30	CD 10A95	30		
100	513,4	505,39	CS 1A100	30				
110	563,9	555,92	CS 1A110	30				
114	584,1	576,13	CS 1A114	30				
120	614,4	606,45	CS 1A120	30				
125	639,7	631,51	CS 1A125	30				

# Corone / Plate wheels Kettenradscheiben / Disques / Discos



Corone per catene semplici, doppie e triple a rulli secondo: DIN 8188 - ISO/R 606 - ANSI B 29,1  
**Corone tornite sui lati, dentate con creatore.**

Plate wheels for simplex, duplex and triplex chain to: DIN 8188 - ISO/R 606 - ANSI B 29,1  
**Plate Wheels turned on both sides and toothed by milling cutter.**

Kettenradscheiben mit einseitiger Nabe für Simplex- Duplex- Triplex-Rollenkette nach: DIN 8188 - ISO/R 606 - ANSI B 29,1  
**Seitlich plan gedrehte, wälzgefräste Zahnkränze.**

Disques avec moyeu déporté pour chaînes simples, doubles et triples à rouleaux suivant les normes: DIN 8188 - ISO/R 606 - ANSI B 29,1  
**Disques tournés sur les flancs, dentés à la fraise.**

Discos para cadena simple, doble y triple de rodillos segun: DIN 8188 - ISO/R 606 - ANSI B 29,1  
**Discos torneadas en los lados, dientes obtenidos con fresa madre.**

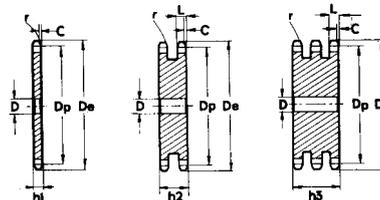

**1"1/2 x 1"**

**ASA 120 - 1-2-3 38,1 x 25,4 mm**

CATENA:	CHAIN:	KETTE:	CHAÎNE:	CADENA:	ASA 60
Passo	Pitch	Teilung	Pas	Paso	<b>19,05</b>
Larghezza interna	Internal width	Innere Breite	Largeur interieure	Ancho interno	<b>12,70</b>
Rullo $\varnothing$	Roller $\varnothing$	Rollen $\varnothing$	$\varnothing$ du rouleau	Rodillo $\varnothing$	<b>11,91</b>

CORONE	PLATE WHEELS	KETTENRADSCHIEBEN	DISQUES	DISCOS	ASA 60
Raggio dente r	Tooth radius r	Radius r	Rayon de denture r	Radio diente r	<b>r 20,0</b>
Larghezza raggio C	Radius width C	Breite C	Largeur de rayon C	Ancho radio C	<b>C 2,4</b>
Largh. dente $h_1$	Tooth width $h_1$	Zahnbreite $h_1$	Larg. de denture $h_1$	Ancho diente $h_1$	<b><math>h_1</math> 12,0</b>
Largh. dente L	Tooth width L	Zahnbreite L	Larg. de denture L	Ancho diente L	<b>L 11,8</b>
Largh. dente $h_2$	Tooth width $h_2$	Zahnbreite $h_2$	Larg. de denture $h_2$	Ancho diente $h_2$	<b><math>h_2</math> 34,6</b>
Largh. dente $h_3$	Tooth width $h_3$	Zahnbreite $h_3$	Larg. de denture $h_3$	Ancho diente $h_3$	<b><math>h_3</math> 57,4</b>
Altezza totale H	Full height H	Gesamt Höhe H	Hauteur totale H	Altura total H	<b>H -</b>

Z	De	Dp	CS		CD		CT	
			cod.	d	cod.	d	cod.	d
30	192,14	182,25					CT 11A30	20
32	204,24	194,35			CD 11A32	20		
38	240,58	230,69	CS 11A38	20	CD 11A38	25	CT 11A38	25
40	252,69	242,80	CS 11A40	20	CD 11A40	25		
45	282,98	273,09	CS 11A45	25	CD 11A45	25	CT 11A45	25
48	301,16	291,27	CS 11A48	25				
57	355,70	345,81	CS 11A57	25	CD 11A57	25	CT 11A57	30
76	470,87	460,98	CS 11A76	25	CD 11A76	30	CT 11A76	30
95	586,06	576,17			CD 11A95	30		

**1" x 5/8"**

**ASA 80 - 1-2-3 25,4 x 15,88 mm**

CATENA:	CHAIN:	KETTE:	CHAÎNE:	CADENA:	ASA 80
Passo	Pitch	Teilung	Pas	Paso	<b>25,40</b>
Larghezza interna	Internal width	Innere Breite	Largeur interieure	Ancho interno	<b>15,88</b>
Rullo $\varnothing$	Roller $\varnothing$	Rollen $\varnothing$	$\varnothing$ du rouleau	Rodillo $\varnothing$	<b>15,88</b>

CORONE	PLATE WHEELS	KETTENRADSCHIEBEN	DISQUES	DISCOS	ASA 80
Raggio dente r	Tooth radius r	Radius r	Rayon de denture r	Radio diente r	<b>r 27,0</b>
Larghezza raggio C	Radius width C	Breite C	Largeur de rayon C	Ancho radio C	<b>C 3,2</b>
Largh. dente $h_1$	Tooth width $h_1$	Zahnbreite $h_1$	Larg. de denture $h_1$	Ancho diente $h_1$	<b><math>h_1</math> 15,0</b>
Largh. dente L	Tooth width L	Zahnbreite L	Larg. de denture L	Ancho diente L	<b>L 14,7</b>
Largh. dente $h_2$	Tooth width $h_2$	Zahnbreite $h_2$	Larg. de denture $h_2$	Ancho diente $h_2$	<b><math>h_2</math> 44,0</b>
Largh. dente $h_3$	Tooth width $h_3$	Zahnbreite $h_3$	Larg. de denture $h_3$	Ancho diente $h_3$	<b><math>h_3</math> 73,3</b>
Altezza totale H	Full height H	Gesamt Höhe H	Hauteur totale H	Altura total H	<b>H -</b>

Z	De	Dp	CS		CD		CT	
			cod.	D	cod.	D	cod.	D
10	95,32	82,19	CS 12A10	15				
11	103,28	90,14	CS 12A11	15				
12	111,26	98,14	CS 12A12	15				
13	119,26	106,12	CS 12A13	15				
14	127,27	114,15	CS 12A14	15				
15	135,29	122,17	CS 12A15	15				
16	143,32	130,20	CS 12A16	20				
17	151,35	138,22	CS 12A17	20				
18	159,39	146,28	CS 12A18	20				
19	167,44	154,33	CS 12A19	20				
20	175,49	162,38	CS 12A20	20				
21	183,54	170,43	CS 12A21	20				
22	191,60	178,48	CS 12A22	20				
23	199,66	186,53	CS 12A23	20				

Z	De	Dp	CS		CD		CT	
			cod.	D	cod.	D	cod.	D
24	207,72	194,59	CS 12A24	20				
25	215,78	202,66	CS 12A25	20	CD 12A25	25	CT 12A25	30
26	223,84	210,72	CS 12A26	20				
27	231,91	218,79	CS 12A27	20				
28	239,98	226,85	CS 12A28	20				
30	256,12	243,00	CS 12A30	20	CD 12A30	25	CT 12A30	30
32	272,26	259,13	CS 12A32	25				
35	296,48	283,36	CS 12A35	25				
38	320,70	307,59	CS 12A38	25	CD 12A38	25	CT 12A38	30
45	377,24	364,12	CS 12A45	25	CD 12A45	25	CT 12A45	30
50	417,64	404,52	CS 12A50	25				
57	474,20	461,08	CS 12A57	25	CD 12A57	25	CT 12A57	40
76	627,80	614,64	CS 12A76	25	CD 12A76	25	CT 12A76	40

Corone per catene semplici, doppie e triple a rulli secondo: DIN 8188 - ISO/R 606 - ANSI B 29,1  
**Corone tornite sui lati, dentate con creatore.**

Plate wheels for simplex, duplex and triplex chain to: DIN 8188 - ISO/R 606 - ANSI B 29,1  
**Plate Wheels turned on both sides and toothed by milling cutter.**

Kettenradscheiben mit einseitiger Nabe für Simplex- Duplex- Triplex-Rollenkette nach: DIN 8188 - ISO/R 606 - ANSI B 29,1  
**Seitlich plan gedrehte, wälzgefräste Zahnkränze.**

Disques avec moyeu déporté pour chaînes simples, doubles et triples à rouleaux suivant les normes: DIN 8188 - ISO/R 606 - ANSI B 29,1  
**Disques tournés sur les flancs, dentés à la fraise.**

Discos para cadena simple, doble y triple de rodillos según: DIN 8188 - ISO/R 606 - ANSI B 29,1  
**Discos torneadas en los lados, dientes obtenidos con fresa madre.**



**1"1/4 x 3/4"**

**ASA 100 - 1-2-3 31,75 x 19,05 mm**

CATENA:	CHAIN:	KETTE:	CHAÎNE:	CADENA:	ASA 100
Passo	Pitch	Teilung	Pas	Paso	<b>31,75</b>
Larghezza interna	Internal width	Innere Breite	Largeur interieure	Ancho interno	<b>19,05</b>
Rullo ø	Roller ø	Rollen ø	ø du rouleau	Rodillo ø	<b>19,05</b>
CORONE	PLATE WHEELS	KETTENRADSCHIEBEN	DISQUES	DISCOS	ASA 100
Raggio dente r	Tooth radius r	Radius r	Rayon de denture r	Radio diente r	<b>r 33,5</b>
Larghezza raggio C	Radius width C	Breite C	Largeur de rayon C	Ancho radio C	<b>C 4,0</b>
Largh. dente h <sub>1</sub>	Tooth width h <sub>1</sub>	Zahnbreite h <sub>1</sub>	Larg. de denture h <sub>1</sub>	Ancho diente h <sub>1</sub>	<b>h<sub>1</sub> 18,0</b>
Largh. dente L	Tooth width L	Zahnbreite L	Larg. de denture L	Ancho diente L	<b>L 17,7</b>
Largh. dente h <sub>2</sub>	Tooth width h <sub>2</sub>	Zahnbreite h <sub>2</sub>	Larg. de denture h <sub>2</sub>	Ancho diente h <sub>2</sub>	<b>h<sub>2</sub> 53,5</b>
Largh. dente h <sub>3</sub>	Tooth width h <sub>3</sub>	Zahnbreite h <sub>3</sub>	Larg. de denture h <sub>3</sub>	Ancho diente h <sub>3</sub>	<b>h<sub>3</sub> 89,2</b>
Altezza totale H	Full height H	Gesamt Höhe H	Hauteur totale H	Altura total H	<b>H -</b>

Z	D <sub>e</sub>	D <sub>p</sub>	CS		CD	
			cod.	D	cod.	D
8	98,1	82,96	CS 15A08	16		
9	108,0	92,84	CS 15A09	16		
10	117,9	102,74	CS 15A10	16		
11	127,8	112,68	CS 15A11	16		
12	137,8	122,68	CS 15A12	20		
13	147,8	132,65	CS 15A13	20		
14	157,8	142,68	CS 15A14	20		
15	167,9	152,72	CS 15A15	20		
16	177,9	162,75	CS 15A16	25		
17	187,9	172,78	CS 15A17	25		
18	198,0	182,85	CS 15A18	25		
19	208,1	192,91	CS 15A19	25		
20	218,1	202,98	CS 15A20	25	CD 05A20	25
21	228,2	213,04	CS 15A21	25		
22	238,3	223,11	CS 15A22	25		
23	248,3	233,17	CS 15A23	25		
24	258,4	243,23	CS 15A24	25		
25	268,5	253,33	CS 15A25	25	CD 15A25	25
26	278,6	263,40	CS 15A26	25		
27	288,6	273,40	CS 15A27	25		
28	298,7	283,56	CS 15A28	25		
29	308,8	293,65	CS 15A29	25		
30	318,9	303,75	CS 15A30	25	CD 15A30	25
31	329,0	313,85	CS 15A31	25		
32	339,1	323,91	CS 15A32	25		
33	349,2	334,01	CS 15A33	25		
34	359,3	344,10	CS 15A34	25		
35	369,4	354,20	CS 15A35	25		
36	379,5	364,30	CS 15A36	25		
37	389,5	374,39	CS 15A37	25		
38	399,6	384,49	CS 15A38	25	CD 15A38	30
39	409,7	394,59	CS 15A39	25		
40	419,8	404,68	CS 15A40	25		
45	470,3	455,17	CS 15A45	30	CD 05A45	30
57	591,5	576,36	CS 15A57	30	CD 05A57	30



# Corone / Plate wheels Kettenradscheiben / Disques / Discos



Corone per catene semplici, doppie e triple a rulli secondo: DIN 8188 - ISO/R 606 - ANSI B 29,1  
**Corone tornite sui lati, dentate con creatore.**

Plate wheels for simplex, duplex and triplex chain to: DIN 8188 - ISO/R 606 - ANSI B 29,1  
**Plate Wheels turned on both sides and toothed by milling cutter.**

Kettenradscheiben mit einseitiger Nabe für Simplex- Duplex- Triplex-Rollenkette nach: DIN 8188 - ISO/R 606 - ANSI B 29,1  
**Seitlich plan gedrehte, wälzgefräste Zahnkränze.**

Disques avec moyeu déporté pour chaînes simples, doubles et triples à rouleaux suivant les normes: DIN 8188 - ISO/R 606 - ANSI B 29,1  
**Disques tournés sur les flancs, dentés à la fraise.**

Discos para cadena simple, doble y triple de rodillos segun: DIN 8188 - ISO/R 606 - ANSI B 29,1  
**Discos torneadas en los lados, dientes obtenidos con fresa madre.**

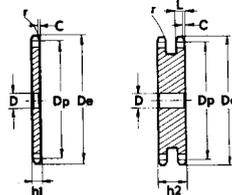

## 1"1/2 x 1"

## ASA 120 - 1-2-3 38,1 x 25,4 mm

CATENA:	CHAIN:	KETTE:	CHAÎNE:	CADENA:	ASA 120
Passo	Pitch	Teilung	Pas	Paso	38,10
Larghezza interna	Internal width	Innere Breite	Largeur interieure	Ancho interno	25,40
Rullo ø	Roller ø	Rollen ø	ø du rouleau	Rodillo ø	22,22

CORONE	PLATE WHEELS	KETTENRADSCHIEBEN	DISQUES	DISCOS	ASA 120
Raggio dente r	Tooth radius r	Radius r	Rayon de denture r	Radio diente r	r 40,5
Larghezza raggio C	Radius width C	Breite C	Largeur de rayon C	Ancho radio C	C 4,8
Largh. dente h <sub>1</sub>	Tooth width h <sub>1</sub>	Zahnbreite h <sub>1</sub>	Larg. de denture h <sub>1</sub>	Ancho diente h <sub>1</sub>	h <sub>1</sub> 24,1
Largh. dente L	Tooth width L	Zahnbreite L	Larg. de denture L	Ancho diente L	L 23,6
Largh. dente h <sub>2</sub>	Tooth width h <sub>2</sub>	Zahnbreite h <sub>2</sub>	Larg. de denture h <sub>2</sub>	Ancho diente h <sub>2</sub>	h <sub>2</sub> 69,0
Largh. dente h <sub>3</sub>	Tooth width h <sub>3</sub>	Zahnbreite h <sub>3</sub>	Larg. de denture h <sub>3</sub>	Ancho diente h <sub>3</sub>	h <sub>3</sub> 114,5
Altezza totale H	Full height H	Gesamt Höhe H	Hauteur totale H	Altura total H	H -

Z	D <sub>e</sub>	D <sub>p</sub>	CS		CD	
			cod.	d	cod.	d
16	214,77	195,29	CS 14A16	25		
17	226,83	207,35	CS 14A17	25	CD 14A17	25
18	238,89	219,41	CS 14A18	25	CD 14A18	25
20	263,03	243,55	CS 14A20	25	CD 14A20	25
22	287,20	267,72	CS 14A22	25		
25	323,47	303,99	CS 14A25	25	CD 14A25	25

Z	D <sub>e</sub>	D <sub>p</sub>	CS		CD	
			cod.	d	cod.	d
30	383,97	364,49	CS 14A30	25	CD 14A30	30
32	408,19	388,71	CS 14A32	30		
38	480,85	461,37	CS 14A38	30	CD 14A38	30
45	565,67	546,19	CS 14A45	30	CD 14A45	40
57	711,10	691,62	CS 14A57	30	CD 14A57	40

## 1"3/4 x 1"1/4

## ASA 140 - 1-2-3 44,45 x 25,4 mm

CATENA:	CHAIN:	KETTE:	CHAÎNE:	CADENA:	ASA 140
Passo	Pitch	Teilung	Pas	Paso	44,45
Larghezza interna	Internal width	Innere Breite	Largeur interieure	Ancho interno	25,40
Rullo ø	Roller ø	Rollen ø	ø du rouleau	Rodillo ø	25,40

CORONE	PLATE WHEELS	KETTENRADSCHIEBEN	DISQUES	DISCOS	ASA 140
Raggio dente r	Tooth radius r	Radius r	Rayon de denture r	Radio diente r	r 47,5
Larghezza raggio C	Radius width C	Breite C	Largeur de rayon C	Ancho radio C	C 5,8
Largh. dente h <sub>1</sub>	Tooth width h <sub>1</sub>	Zahnbreite h <sub>1</sub>	Larg. de denture h <sub>1</sub>	Ancho diente h <sub>1</sub>	h <sub>1</sub> 24,1
Largh. dente L	Tooth width L	Zahnbreite L	Larg. de denture L	Ancho diente L	L 23,6
Largh. dente h <sub>2</sub>	Tooth width h <sub>2</sub>	Zahnbreite h <sub>2</sub>	Larg. de denture h <sub>2</sub>	Ancho diente h <sub>2</sub>	h <sub>2</sub> 72,5
Largh. dente h <sub>3</sub>	Tooth width h <sub>3</sub>	Zahnbreite h <sub>3</sub>	Larg. de denture h <sub>3</sub>	Ancho diente h <sub>3</sub>	h <sub>3</sub> 121,3
Altezza totale H	Full height H	Gesamt Höhe H	Hauteur totale H	Altura total H	H -

## 2" x 1"1/4

## ASA 160 - 1-2-3 50,8 x 31,75 mm

CATENA:	CHAIN:	KETTE:	CHAÎNE:	CADENA:	ASA 160
Passo	Pitch	Teilung	Pas	Paso	50,80
Larghezza interna	Internal width	Innere Breite	Largeur interieure	Ancho interno	31,75
Rullo ø	Roller ø	Rollen ø	ø du rouleau	Rodillo ø	28,58

CORONE	PLATE WHEELS	KETTENRADSCHIEBEN	DISQUES	DISCOS	ASA 160
Raggio dente r	Tooth radius r	Radius r	Rayon de denture r	Radio diente r	r 54,0
Larghezza raggio C	Radius width C	Breite C	Largeur de rayon C	Ancho radio C	C 7,0
Largh. dente h <sub>1</sub>	Tooth width h <sub>1</sub>	Zahnbreite h <sub>1</sub>	Larg. de denture h <sub>1</sub>	Ancho diente h <sub>1</sub>	h <sub>1</sub> 30,1
Largh. dente L	Tooth width L	Zahnbreite L	Larg. de denture L	Ancho diente L	L 29,5
Largh. dente h <sub>2</sub>	Tooth width h <sub>2</sub>	Zahnbreite h <sub>2</sub>	Larg. de denture h <sub>2</sub>	Ancho diente h <sub>2</sub>	h <sub>2</sub> 88,0
Largh. dente h <sub>3</sub>	Tooth width h <sub>3</sub>	Zahnbreite h <sub>3</sub>	Larg. de denture h <sub>3</sub>	Ancho diente h <sub>3</sub>	h <sub>3</sub> 146,6
Altezza totale H	Full height H	Gesamt Höhe H	Hauteur totale H	Altura total H	H -

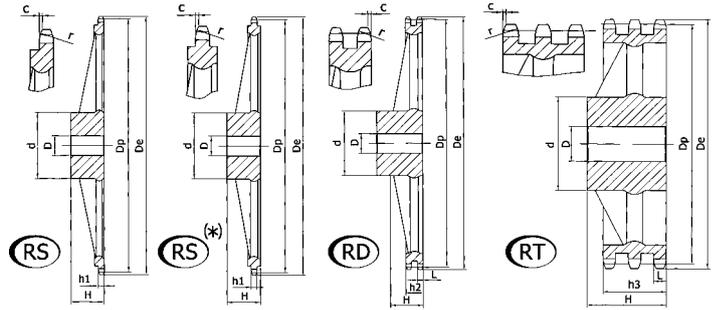

<b>Ghisa</b> EN-GJL-250 UNI EN 1561	<b>Cast iron</b> EN-GJL-250 UNI EN 1561	<b>Grauguss</b> EN-GJL-250 UNI EN 1561	<b>Fonte</b> EN-GJL-250 UNI EN 1561	<b>Hierro fundido</b> EN-GJL-250 UNI EN 1561
--	--	---	--	---

**3/8" x 7/32" - 9,525 x 5,72 mm**

**06B - 1 - 2 - 3 - DIN 8187 ISO/R 606**

<b>CATENA:</b>	<b>CHAIN:</b>	<b>KETTE:</b>	<b>CHAÎNE:</b>	<b>CADENA:</b>	<b>mm</b>
Passo	Pitch	Teilung	Pas	Paso	<b>9,525</b>
Larghezza interna	Internal width	Innere Breite	Largeur interieure	Ancho interno	<b>5,720</b>
Rullo ø	Roller ø	Rollen ø	ø du rouleau	Rodillo ø	<b>6,350</b>

<b>PIGNONE</b>	<b>SPROCKETS</b>	<b>KETTENRÄDER</b>	<b>PIGNONS</b>	<b>PIÑONES</b>	<b>mm</b>
Raggio dente r	Tooth radius r	Radius r	Rayon de denture r	Radio diente r	<b>r 10,0</b>
Larghezza raggio C	Radius width C	Breite C	Largeur de rayon C	Ancho radio C	<b>C 1,0</b>
Largh. dente h <sub>1</sub>	Tooth width h <sub>1</sub>	Zahnbreite h <sub>1</sub>	Larg. de denture h <sub>1</sub>	Ancho diente h <sub>1</sub>	<b>h<sub>1</sub> 5,3</b>
Largh. dente L	Tooth width L	Zahnbreite L	Larg. de denture L	Ancho diente L	<b>L 5,2</b>
Largh. dente h <sub>2</sub>	Tooth width h <sub>2</sub>	Zahnbreite h <sub>2</sub>	Larg. de denture h <sub>2</sub>	Ancho diente h <sub>2</sub>	<b>h<sub>2</sub> 15,4</b>
Largh. dente h <sub>3</sub>	Tooth width h <sub>3</sub>	Zahnbreite h <sub>3</sub>	Larg. de denture h <sub>3</sub>	Ancho diente h <sub>3</sub>	<b>h<sub>3</sub> 25,6</b>
Altezza totale H	Full height H	Gesamt Höhe H	Hauteur totale H	Altura total H	<b>H -</b>

Z	D <sub>e</sub>	D <sub>p</sub>	RS			RD			RT					
			cod.	d	D	H	cod.	d	D	H	cod.	d	D	H
38	119,5	115,34	RS 05038	70	19	32	RD 05038	80	19	40	RT 05038	90	23	56
45	140,7	136,54	RS 05045	70	19	32	RD 05045	80	19	40	RT 05045	90	23	56
57	176,9	172,91	RS 05057	70	19	32	RD 05057	80	19	40	RT 05057	90	23	56
76	234,9	230,49	RS 05076	70	19	32	RD 05076	80	19	40	RT 05076	100	23	56
* 95	292,5	288,08	RS 05095	80	19	40	RD 05095	90	19	45	RT 05095	100	23	56
* 114	349,6	345,68	RS 05114	80	19	40	RD 05114	95	19	45	RT 05114	100	23	56
* 150	459,2	454,82	RS 05150	90	23	45	RD 05150	100	23	50	RT 05150	125	23	60

**1/2" x 5/16" - 12,7 x 7,75 mm**

**08B - 1 - 2 - 3 - DIN 8187 ISO/R 606**

<b>CATENA:</b>	<b>CHAIN:</b>	<b>KETTE:</b>	<b>CHAÎNE:</b>	<b>CADENA:</b>	<b>mm</b>
Passo	Pitch	Teilung	Pas	Paso	<b>12,70</b>
Larghezza interna	Internal width	Innere Breite	Largeur interieure	Ancho interno	<b>7,75</b>
Rullo ø	Roller ø	Rollen ø	ø du rouleau	Rodillo ø	<b>8,51</b>

<b>PIGNONE</b>	<b>SPROCKETS</b>	<b>KETTENRÄDER</b>	<b>PIGNONS</b>	<b>PIÑONES</b>	<b>mm</b>
Raggio dente r	Tooth radius r	Radius r	Rayon de denture r	Radio diente r	<b>r 13,0</b>
Larghezza raggio C	Radius width C	Breite C	Largeur de rayon C	Ancho radio C	<b>C 1,3</b>
Largh. dente h <sub>1</sub>	Tooth width h <sub>1</sub>	Zahnbreite h <sub>1</sub>	Larg. de denture h <sub>1</sub>	Ancho diente h <sub>1</sub>	<b>h<sub>1</sub> 7,2</b>
Largh. dente L	Tooth width L	Zahnbreite L	Larg. de denture L	Ancho diente L	<b>L 7,0</b>
Largh. dente h <sub>2</sub>	Tooth width h <sub>2</sub>	Zahnbreite h <sub>2</sub>	Larg. de denture h <sub>2</sub>	Ancho diente h <sub>2</sub>	<b>h<sub>2</sub> 21,0</b>
Largh. dente h <sub>3</sub>	Tooth width h <sub>3</sub>	Zahnbreite h <sub>3</sub>	Larg. de denture h <sub>3</sub>	Ancho diente h <sub>3</sub>	<b>h<sub>3</sub> 34,9</b>
Altezza totale H	Full height H	Gesamt Höhe H	Hauteur totale H	Altura total H	<b>H -</b>

Z	D <sub>e</sub>	D <sub>p</sub>	RS			RD			RT					
			cod.	d	D	H	cod.	d	D	H	cod.	d	D	H
38	158,6	153,80	RS 09038	70	19	40	RD 09038	90	23	50	RT 09038	100	23	60
45	188,0	182,07	RS 09045	70	19	40	RD 09045	90	23	50	RT 09045	100	23	60
57	236,4	230,54	RS 09057	70	19	40	RD 09057	90	23	50	RT 09057	100	23	60
76	313,3	307,33	RS 09076	80	23	40	RD 09076	100	23	56	RT 09076	100	23	60
* 95	390,1	384,11	RS 09095	80	23	45	RD 09095	100	23	56	RT 09095	120	23	67
* 114	466,9	460,90	RS 09114	80	23	45	RD 09114	100	23	63	RT 09114	120	23	67

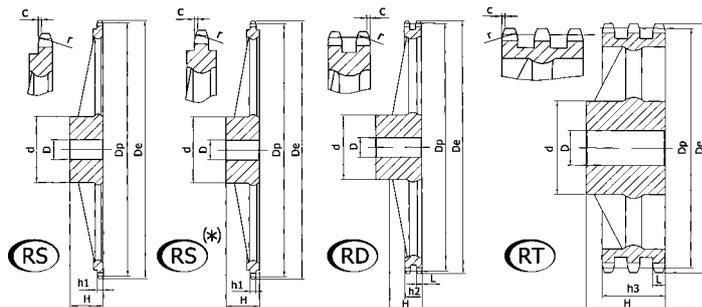

**Ghisa** EN-GJL-250 UNI EN 1561      **Cast iron** EN-GJL-250 UNI EN 1561      **Grauguss** EN-GJL-250 UNI EN 1561      **Fonte** EN-GJL-250 UNI EN 1561      **Hierro fundido** EN-GJL-250 UNI EN 1561

**5/8" x 3/8" - 15,875 x 9,65 mm**

**10B - 1 - 2 - 3 - DIN 8187 ISO/R 606**

CATENA:	CHAIN:	KETTE:	CHAÎNE:	CADENA:	mm
Passo	Pitch	Teilung	Pas	Paso	<b>15,875</b>
Larghezza interna	Internal width	Innere Breite	Largeur interieure	Ancho interno	<b>9,650</b>
Rullo ø	Roller ø	Rollen ø	ø du rouleau	Rodillo ø	<b>10,160</b>

PIGNONE	SPROCKETS	KETTENRÄDER	PIGNONS	PIÑONES	mm
Raggio dente r	Tooth radius r	Radius r	Rayon de denture r	Radio diente r	<b>r 16,0</b>
Larghezza raggio C	Radius width C	Breite C	Largeur de rayon C	Ancho radio C	<b>C 1,6</b>
Largh. dente h <sub>1</sub>	Tooth width h <sub>1</sub>	Zahnbreite h <sub>1</sub>	Larg. de denture h <sub>1</sub>	Ancho diente h <sub>1</sub>	<b>h<sub>1</sub> 9,1</b>
Largh. dente L	Tooth width L	Zahnbreite L	Larg. de denture L	Ancho diente L	<b>L 9,0</b>
Largh. dente h <sub>2</sub>	Tooth width h <sub>2</sub>	Zahnbreite h <sub>2</sub>	Larg. de denture h <sub>2</sub>	Ancho diente h <sub>2</sub>	<b>h<sub>2</sub> 25,5</b>
Largh. dente h <sub>3</sub>	Tooth width h <sub>3</sub>	Zahnbreite h <sub>3</sub>	Larg. de denture h <sub>3</sub>	Ancho diente h <sub>3</sub>	<b>h<sub>3</sub> 42,1</b>
Altezza totale H	Full height H	Gesamt Höhe H	Hauteur totale H	Altura total H	<b>H -</b>

Z	D <sub>e</sub>	D <sub>p</sub>	RS			RD			RT					
			cod.	d	D	H	cod.	d	D	H	cod.	d	D	H
38	199,2	192,24	RS 10038	80	19	40	RD 10038	100	29	50	RT 10038	100	31	60
45	235,0	227,58	RS 10045	80	19	40	RD 10045	100	29	50	RT 10045	100	31	60
57	296,0	288,18	RS 10057	90	23	45	RD 10057	100	29	56	RT 10057	100	31	63
* 76	392,1	384,16	RS 10076	90	23	50	RD 10076	100	29	63	RT 10076	110	34	67
* 95	488,5	480,14	RS 10095	100	23	56	RD 10095	110	29	63	RT 10095	125	34	70
* 114	584,1	576,13	RS 10114	100	23	56	RD 10114	125	29	70	RT 10114	125	34	80

**3/4" x 7/16" - 19,05 x 11,68 mm**

**12B - 1 - 2 - 3 - DIN 8187 ISO/R 606**

CATENA:	CHAIN:	KETTE:	CHAÎNE:	CADENA:	mm
Passo	Pitch	Teilung	Pas	Paso	<b>19,05</b>
Larghezza interna	Internal width	Innere Breite	Largeur interieure	Ancho interno	<b>11,68</b>
Rullo ø	Roller ø	Rollen ø	ø du rouleau	Rodillo ø	<b>12,07</b>

PIGNONE	SPROCKETS	KETTENRÄDER	PIGNONS	PIÑONES	mm
Raggio dente r	Tooth radius r	Radius r	Rayon de denture r	Radio diente r	<b>r 19,0</b>
Larghezza raggio C	Radius width C	Breite C	Largeur de rayon C	Ancho radio C	<b>C 2,0</b>
Largh. dente h <sub>1</sub>	Tooth width h <sub>1</sub>	Zahnbreite h <sub>1</sub>	Larg. de denture h <sub>1</sub>	Ancho diente h <sub>1</sub>	<b>h<sub>1</sub> 11,1</b>
Largh. dente L	Tooth width L	Zahnbreite L	Larg. de denture L	Ancho diente L	<b>L 10,8</b>
Largh. dente h <sub>2</sub>	Tooth width h <sub>2</sub>	Zahnbreite h <sub>2</sub>	Larg. de denture h <sub>2</sub>	Ancho diente h <sub>2</sub>	<b>h<sub>2</sub> 30,3</b>
Largh. dente h <sub>3</sub>	Tooth width h <sub>3</sub>	Zahnbreite h <sub>3</sub>	Larg. de denture h <sub>3</sub>	Ancho diente h <sub>3</sub>	<b>h<sub>3</sub> 49,8</b>
Altezza totale H	Full height H	Gesamt Höhe H	Hauteur totale H	Altura total H	<b>H -</b>

Z	D <sub>e</sub>	D <sub>p</sub>	RS			RD			RT					
			cod.	d	D	H	cod.	d	D	H	cod.	d	D	H
38	239,0	230,69	RS 11038	100	23	56	RD 11038	110	29	63	RT 11038	140	30	70
45	282,5	273,10	RS 11045	100	23	56	RD 11045	110	29	63	RT 11045	140	30	70
57	355,4	345,81	RS 11057	100	29	56	RD 11057	120	29	63	RT 11057	140	39	70
* 76	469,9	460,99	RS 11076	100	29	56	RD 11076	135	29	63	RT 11076	160	39	75
* 95	585,1	576,17	RS 11095	100	29	65	RD 11095	135	29	70	RT 11095	170	39	82
* 114	700,6	691,36	RS 11114	100	29	65	RD 11114	135	29	70	RT 11114	170	49	82

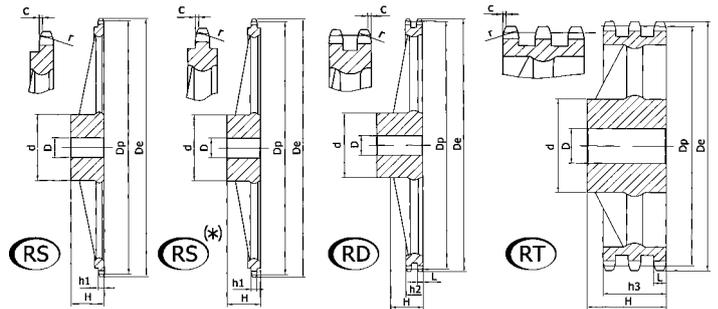

<b>Ghisa</b> EN-GJL-250 UNI EN 1561	<b>Cast iron</b> EN-GJL-250 UNI EN 1561	<b>Grauguss</b> EN-GJL-250 UNI EN 1561	<b>Fonte</b> EN-GJL-250 UNI EN 1561	<b>Hierro fundido</b> EN-GJL-250 UNI EN 1561
--	--	---	--	---

**1" x 17,02 mm - 25,4 x 17,02 mm**

**16B - 1 - 2 - 3 - DIN 8187 ISO/R 606**

CATENA:	CHAIN:	KETTE:	CHAÎNE:	CADENA:	mm
Passo	Pitch	Teilung	Pas	Paso	<b>25,40</b>
Larghezza interna	Internal width	Innere Breite	Largeur interieure	Ancho interno	<b>17,02</b>
Rullo ø	Roller ø	Rollen ø	ø du rouleau	Rodillo ø	<b>15,88</b>

PIGNONE	SPROCKETS	KETTENRÄDER	PIGNONS	PIÑONES	mm
Raggio dente r	Tooth radius r	Radius r	Rayon de denture r	Radio diente r	<b>r 26,0</b>
Larghezza raggio C	Radius width C	Breite C	Largeur de rayon C	Ancho radio C	<b>C 2,5</b>
Largh. dente h <sub>1</sub>	Tooth width h <sub>1</sub>	Zahnbreite h <sub>1</sub>	Larg. de denture h <sub>1</sub>	Ancho diente h <sub>1</sub>	<b>h<sub>1</sub> 16,2</b>
Largh. dente L	Tooth width L	Zahnbreite L	Larg. de denture L	Ancho diente L	<b>L 15,8</b>
Largh. dente h <sub>2</sub>	Tooth width h <sub>2</sub>	Zahnbreite h <sub>2</sub>	Larg. de denture h <sub>2</sub>	Ancho diente h <sub>2</sub>	<b>h<sub>2</sub> 47,7</b>
Largh. dente h <sub>3</sub>	Tooth width h <sub>3</sub>	Zahnbreite h <sub>3</sub>	Larg. de denture h <sub>3</sub>	Ancho diente h <sub>3</sub>	<b>h<sub>3</sub> 79,6</b>
Altezza totale H	Full height H	Gesamt Höhe H	Hauteur totale H	Altura total H	<b>H -</b>

Z	D <sub>e</sub>	D <sub>p</sub>	RS				RD				RT			
			cod.	d	D	H	cod.	d	D	H	cod.	d	D	H
<b>38</b>	320,0	307,59	RS 12038	110	29	65	RD 12038	140	39	75	RT 12038	160	44	100
<b>45</b>	377,1	364,12	RS 12045	125	29	70	RD 12045	150	39	75	RT 12045	160	44	100
<b>57</b>	474,0	461,07	RS 12057	125	34	70	RD 12057	170	39	90	RT 12057	165	44	100
<b>76</b>	627,0	614,65	RS 12076	140	34	80	RD 12076	175	39	95	RT 12076	200	44	110
<b>95</b>	781,1	768,22	RS 12095	140	39	80	RD 12095	175	44	95	RT 12095	200	49	110
<b>* 114</b>	934,3	921,81	RS 12114	140	39	80	RD 12114	175	44	95	RT 12114	200	49	115

**1"1/4 x 3/4" - 31,75 x 19,56 mm**

**20B - 1 - 2 - 3 - DIN 8187 ISO/R 606**

CATENA:	CHAIN:	KETTE:	CHAÎNE:	CADENA:	mm
Passo	Pitch	Teilung	Pas	Paso	<b>31,75</b>
Larghezza interna	Internal width	Innere Breite	Largeur interieure	Ancho interno	<b>19,56</b>
Rullo ø	Roller ø	Rollen ø	ø du rouleau	Rodillo ø	<b>19,05</b>

PIGNONE	SPROCKETS	KETTENRÄDER	PIGNONS	PIÑONES	mm
Raggio dente r	Tooth radius r	Radius r	Rayon de denture r	Radio diente r	<b>r 32,0</b>
Larghezza raggio C	Radius width C	Breite C	Largeur de rayon C	Ancho radio C	<b>C 3,5</b>
Largh. dente h <sub>1</sub>	Tooth width h <sub>1</sub>	Zahnbreite h <sub>1</sub>	Larg. de denture h <sub>1</sub>	Ancho diente h <sub>1</sub>	<b>h<sub>1</sub> 18,5</b>
Largh. dente L	Tooth width L	Zahnbreite L	Larg. de denture L	Ancho diente L	<b>L 18,2</b>
Largh. dente h <sub>2</sub>	Tooth width h <sub>2</sub>	Zahnbreite h <sub>2</sub>	Larg. de denture h <sub>2</sub>	Ancho diente h <sub>2</sub>	<b>h<sub>2</sub> 54,6</b>
Largh. dente h <sub>3</sub>	Tooth width h <sub>3</sub>	Zahnbreite h <sub>3</sub>	Larg. de denture h <sub>3</sub>	Ancho diente h <sub>3</sub>	<b>h<sub>3</sub> 91,0</b>
Altezza totale H	Full height H	Gesamt Höhe H	Hauteur totale H	Altura total H	<b>H -</b>

Z	D <sub>e</sub>	D <sub>p</sub>	RS				RD				RT			
			cod.	d	D	H	cod.	d	D	H	cod.	d	D	H
<b>38</b>	399,6	384,49	RS 13038	125	35	70	RD 13038	140	44	90	RT 13038	180	56	110
<b>45</b>	470,3	455,17	RS 13045	125	35	70	RD 13045	140	44	90	RT 13045	180	56	110
<b>57</b>	591,5	576,36	RS 13057	135	40	80	RD 13057	160	50	100	RT 13057	180	60	125
<b>76</b>	783,5	768,32	RS 13076	140	40	90	RD 13076	180	50	100	RT 13076	200	60	140

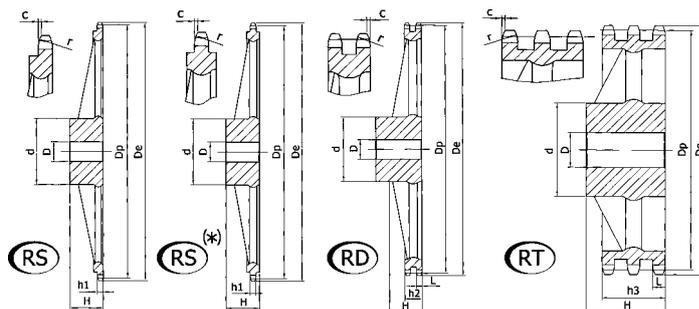

**Ghisa** EN-GJL-250 UNI EN 1561      **Cast iron** EN-GJL-250 UNI EN 1561      **Grauguss** EN-GJL-250 UNI EN 1561      **Fonte** EN-GJL-250 UNI EN 1561      **Hierro fundido** EN-GJL-250 UNI EN 1561

**1"1/2 x 1" - 38,1 x 25,4 mm**

**24B - 1 - 2 - 3 - DIN 8187 ISO/R 606**

CATENA:	CHAIN:	KETTE:	CHAÎNE:	CADENA:	mm
Passo	Pitch	Teilung	Pas	Paso	<b>38,1</b>
Larghezza interna	Internal width	Innere Breite	Largeur interieure	Ancho interno	<b>25,4</b>
Rullo ø	Roller ø	Rollen ø	ø du rouleau	Rodillo ø	<b>25,4</b>

PIGNONE	SPROCKETS	KETTENRÄDER	PIGNONS	PIÑONES	mm
Raggio dente r	Tooth radius r	Radius r	Rayon de denture r	Radio diente r	<b>r 38,0</b>
Larghezza raggio C	Radius width C	Breite C	Largeur de rayon C	Ancho radio C	<b>C 4,0</b>
Largh. dente h <sub>1</sub>	Tooth width h <sub>1</sub>	Zahnbreite h <sub>1</sub>	Larg. de denture h <sub>1</sub>	Ancho diente h <sub>1</sub>	<b>h<sub>1</sub> 24,1</b>
Largh. dente L	Tooth width L	Zahnbreite L	Larg. de denture L	Ancho diente L	<b>L 23,6</b>
Largh. dente h <sub>2</sub>	Tooth width h <sub>2</sub>	Zahnbreite h <sub>2</sub>	Larg. de denture h <sub>2</sub>	Ancho diente h <sub>2</sub>	<b>h<sub>2</sub> 72,0</b>
Largh. dente h <sub>3</sub>	Tooth width h <sub>3</sub>	Zahnbreite h <sub>3</sub>	Larg. de denture h <sub>3</sub>	Ancho diente h <sub>3</sub>	<b>h<sub>3</sub> 120,3</b>
Altezza totale H	Full height H	Gesamt Höhe H	Hauteur totale H	Altura total H	<b>H -</b>

Z	D <sub>e</sub>	D <sub>p</sub>	RS			RD			RT					
			cod.	d	D	H	cod.	d	D	H	cod.	d	D	H
<b>38</b>	476,2	461,39	RS 14038	140	45	90	RD 14038	180	45	100	RT 14038	200	60	150
<b>45</b>	561,2	546,20	RS 14045	140	45	90	RD 14045	180	45	100	RT 14045	200	60	150
<b>57</b>	706,5	691,63	RS 14057	160	45	100	RD 14057	200	55	110	RT 14057	200	70	150
<b>76</b>	936,9	921,98	RS 14076	170	45	100	RD 14076	220	55	120	RT 14076	250	70	150
<b>* 95</b>	1167,3	1152,33	RS 14095	200	50	125	RD 14095	220	55	140				

**Pignoni in ghisa per bussola / Taper bored cast iron sprockets**  
**Kettenräder aus Gusseisen für Spannbuchsen / Roues en fonte à moyeu amovible**  
**Rueda en fundicion para casquillos conicos**

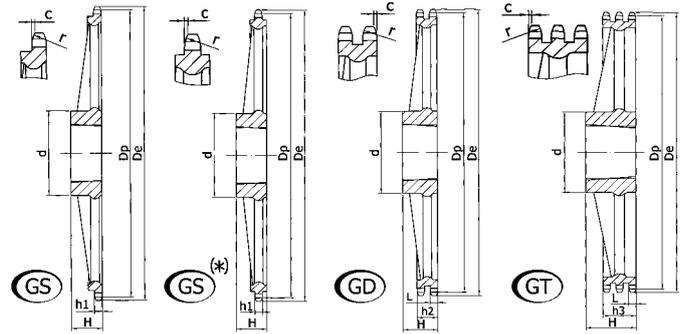

<b>Ghisa</b>	<b>Cast iron</b>	<b>Grauguss</b>	<b>Fonte</b>	<b>Hierro fundido</b>
<b>EN-GJL-250 UNI EN 1561</b>	<b>EN-GJL-250 UNI EN 1561</b>	<b>EN-GJL-250 UNI EN 1561</b>	<b>EN-GJL-250 UNI EN 1561</b>	<b>EN-GJL-250 UNI EN 1561</b>

**3/8" x 7/32" - 9,525 x 5,72 mm**

**06B - 1 - 2 - 3 - DIN 8187 ISO/R 606**

CATENA:	CHAIN:	KETTE:	CHAÎNE:	CADENA:	mm
Passo	Pitch	Teilung	Pas	Paso	<b>9,525</b>
Larghezza interna	Internal width	Innere Breite	Largeur interieure	Ancho interno	<b>5,720</b>
Rullo ø	Roller ø	Rollen ø	ø du rouleau	Rodillo ø	<b>6,350</b>
PIGNONE	SPROCKETS	KETTENRÄDER	PIGNONS	PIÑONES	mm
Raggio dente r	Tooth radius r	Radius r	Rayon de denture r	Radio diente r	<b>r</b>
Larghezza raggio C	Radius width C	Breite C	Largeur de rayon C	Ancho radio C	<b>C</b>
Largh. dente h <sub>1</sub>	Tooth width h <sub>1</sub>	Zahnbreite h <sub>1</sub>	Larg. de denture h <sub>1</sub>	Ancho diente h <sub>1</sub>	<b>h<sub>1</sub></b>
Largh. dente L	Tooth width L	Zahnbreite L	Larg. de denture L	Ancho diente L	<b>L</b>
Largh. dente h <sub>2</sub>	Tooth width h <sub>2</sub>	Zahnbreite h <sub>2</sub>	Larg. de denture h <sub>2</sub>	Ancho diente h <sub>2</sub>	<b>h<sub>2</sub></b>
Largh. dente h <sub>3</sub>	Tooth width h <sub>3</sub>	Zahnbreite h <sub>3</sub>	Larg. de denture h <sub>3</sub>	Ancho diente h <sub>3</sub>	<b>h<sub>3</sub></b>
Altezza totale H	Full height H	Gesamt Höhe H	Hauteur totale H	Altura total H	<b>H</b>

Z	D <sub>e</sub>	D <sub>p</sub>	GS				GD				GT			
			cod.	d	D	per Bussola for Bush für Buchse pour Moyeux amovibles para Casquillos cónicos	cod.	d	D	per Bussola for Bush für Buchse pour Moyeux amovibles para Casquillos cónicos	cod.	d	D	per Bussola for Bush für Buchse pour Moyeux amovibles para Casquillos cónicos
45	140,7	136,54	GS 05045	70	25	1210	GD 05045	80	25	1610	GT 05045	80	38	1615
57	176,9	172,91	GS 05057	83	25	1210	GD 05057	90	25	1610	GT 05057	90	38	1615
76	234,9	230,49	GS 05076	83	25	1210	GD 05076	90	25	1610	GT 05076	111	32	2012
95	292,5	288,08	GS 05095	83	25	1210	GD 05095	90	25	1610	GT 05095	111	32	2012
* 114	349,6	345,68	GS 05114	83	38	1215	GD 05114	90	38	1615	GT 05114	111	32	2012

**1/2" x 5/16" - 12,7 x 7,75 mm**

**08B - 1 - 2 - 3 - DIN 8187 ISO/R 606**

CATENA:	CHAIN:	KETTE:	CHAÎNE:	CADENA:	mm
Passo	Pitch	Teilung	Pas	Paso	<b>12,70</b>
Larghezza interna	Internal width	Innere Breite	Largeur interieure	Ancho interno	<b>7,75</b>
Rullo ø	Roller ø	Rollen ø	ø du rouleau	Rodillo ø	<b>8,51</b>
PIGNONE	SPROCKETS	KETTENRÄDER	PIGNONS	PIÑONES	mm
Raggio dente r	Tooth radius r	Radius r	Rayon de denture r	Radio diente r	<b>r</b>
Larghezza raggio C	Radius width C	Breite C	Largeur de rayon C	Ancho radio C	<b>C</b>
Largh. dente h <sub>1</sub>	Tooth width h <sub>1</sub>	Zahnbreite h <sub>1</sub>	Larg. de denture h <sub>1</sub>	Ancho diente h <sub>1</sub>	<b>h<sub>1</sub></b>
Largh. dente L	Tooth width L	Zahnbreite L	Larg. de denture L	Ancho diente L	<b>L</b>
Largh. dente h <sub>2</sub>	Tooth width h <sub>2</sub>	Zahnbreite h <sub>2</sub>	Larg. de denture h <sub>2</sub>	Ancho diente h <sub>2</sub>	<b>h<sub>2</sub></b>
Largh. dente h <sub>3</sub>	Tooth width h <sub>3</sub>	Zahnbreite h <sub>3</sub>	Larg. de denture h <sub>3</sub>	Ancho diente h <sub>3</sub>	<b>h<sub>3</sub></b>
Altezza totale H	Full height H	Gesamt Höhe H	Hauteur totale H	Altura total H	<b>H</b>

Z	D <sub>e</sub>	D <sub>p</sub>	GS				GD				GT			
			cod.	d	D	per Bussola for Bush für Buchse pour Moyeux amovibles para Casquillos cónicos	cod.	d	D	per Bussola for Bush für Buchse pour Moyeux amovibles para Casquillos cónicos	cod.	d	D	per Bussola for Bush für Buchse pour Moyeux amovibles para Casquillos cónicos
45	188,0	182,07	GS 09045	100	32	2012	GD 09045	100	32	2012	GT 09045	118	45	2517
57	236,4	230,54	GS 09057	111	32	2012	GD 09057	111	32	2012	GT 09057	124	45	2517
76	313,3	307,33	GS 09076	111	32	2012	GD 09076	111	32	2012	GT 09076	124	45	2517
95	390,1	384,11	GS 09095	111	32	2012	GD 09095	111	32	2012	GT 09095	160	51	3020
* 114	466,9	460,90	GS 09114	124	45	2517	GD 09114	124	45	2517	GT 09114	160	51	3020

**Pignoni in ghisa per bussola / Taper bored cast iron sprockets**  
**Kettenräder aus Gusseisen für Spannbuchsen / Roues en fonte à moyeu amovible**  
**Rueda en fundicion para casquillos conicos**

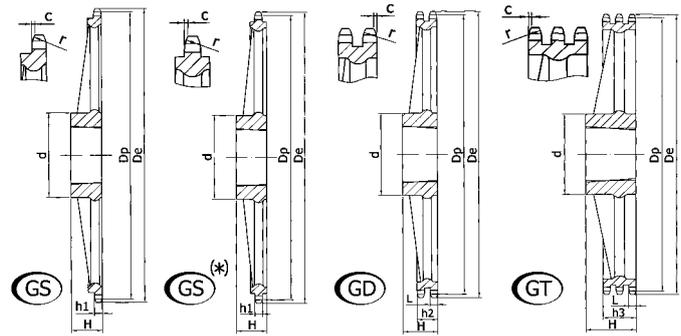

**Ghisa** EN-GJL-250 UNI EN 1561    **Cast iron** EN-GJL-250 UNI EN 1561    **Grauguss** EN-GJL-250 UNI EN 1561    **Fonte** EN-GJL-250 UNI EN 1561    **Hierro fundido** EN-GJL-250 UNI EN 1561

**5/8" x 3/8" - 15,875 x 9,65 mm**

**10B - 1 - 2 - 3 - DIN 8187 ISO/R 606**

CATENA:	CHAIN:	KETTE:	CHAÎNE:	CADENA:	mm
Passo	Pitch	Teilung	Pas	Paso	<b>15,875</b>
Larghezza interna	Internal width	Innere Breite	Largeur interieure	Ancho interno	<b>9,650</b>
Rullo ø	Roller ø	Rollen ø	ø du rouleau	Rodillo ø	<b>10,160</b>
PIGNONE	SPROCKETS	KETTENRÄDER	PIGNONS	PIÑONES	mm
Raggio dente r	Tooth radius r	Radius r	Rayon de denture r	Radio diente r	<b>r</b> <b>16,0</b>
Larghezza raggio C	Radius width C	Breite C	Largeur de rayon C	Ancho radio C	<b>C</b> <b>1,6</b>
Largh. dente h <sub>1</sub>	Tooth width h <sub>1</sub>	Zahnbreite h <sub>1</sub>	Larg. de denture h <sub>1</sub>	Ancho diente h <sub>1</sub>	<b>h<sub>1</sub></b> <b>9,1</b>
Largh. dente L	Tooth width L	Zahnbreite L	Larg. de denture L	Ancho diente L	<b>L</b> <b>9,0</b>
Largh. dente h <sub>2</sub>	Tooth width h <sub>2</sub>	Zahnbreite h <sub>2</sub>	Larg. de denture h <sub>2</sub>	Ancho diente h <sub>2</sub>	<b>h<sub>2</sub></b> <b>25,5</b>
Largh. dente h <sub>3</sub>	Tooth width h <sub>3</sub>	Zahnbreite h <sub>3</sub>	Larg. de denture h <sub>3</sub>	Ancho diente h <sub>3</sub>	<b>h<sub>3</sub></b> <b>42,1</b>
Altezza totale H	Full height H	Gesamt Höhe H	Hauteur totale H	Altura total H	<b>H</b> <b>-</b>

Z	D <sub>e</sub>	D <sub>p</sub>	GS			GD			GT					
			cod.	d	D	cod.	d	D	cod.	d	D			
<b>45</b>	235,0	227,58	GS 10045	100	32	2012	GD 10045	110	45	2517	GT 10045	118	64	2525
<b>57</b>	296,0	288,18	GS 10057	111	32	2012	GD 10057	124	45	2517	GT 10057	160	51	3020
<b>76</b>	392,1	384,16	GS 10076	111	32	2012	GD 10076	160	51	3020	GT 10076	160	51	3020
<b>*95</b>	488,5	480,14	GS 10095	124	45	2517	GD 10095	160	51	3020	GT 10095	160	51	3020
<b>*114</b>	584,1	576,13	GS 10114	124	45	2517	GD 10114	160	51	3020	GT 10114	160	51	3020

**3/4" x 7/16" - 19,05 x 11,68 mm**

**12B - 1 - 2 - 3 - DIN 8187 ISO/R 606**

CATENA:	CHAIN:	KETTE:	CHAÎNE:	CADENA:	mm
Passo	Pitch	Teilung	Pas	Paso	<b>19,05</b>
Larghezza interna	Internal width	Innere Breite	Largeur interieure	Ancho interno	<b>11,68</b>
Rullo ø	Roller ø	Rollen ø	ø du rouleau	Rodillo ø	<b>12,07</b>
PIGNONE	SPROCKETS	KETTENRÄDER	PIGNONS	PIÑONES	mm
Raggio dente r	Tooth radius r	Radius r	Rayon de denture r	Radio diente r	<b>r</b> <b>19,0</b>
Larghezza raggio C	Radius width C	Breite C	Largeur de rayon C	Ancho radio C	<b>C</b> <b>2,0</b>
Largh. dente h <sub>1</sub>	Tooth width h <sub>1</sub>	Zahnbreite h <sub>1</sub>	Larg. de denture h <sub>1</sub>	Ancho diente h <sub>1</sub>	<b>h<sub>1</sub></b> <b>11,1</b>
Largh. dente L	Tooth width L	Zahnbreite L	Larg. de denture L	Ancho diente L	<b>L</b> <b>10,8</b>
Largh. dente h <sub>2</sub>	Tooth width h <sub>2</sub>	Zahnbreite h <sub>2</sub>	Larg. de denture h <sub>2</sub>	Ancho diente h <sub>2</sub>	<b>h<sub>2</sub></b> <b>30,3</b>
Largh. dente h <sub>3</sub>	Tooth width h <sub>3</sub>	Zahnbreite h <sub>3</sub>	Larg. de denture h <sub>3</sub>	Ancho diente h <sub>3</sub>	<b>h<sub>3</sub></b> <b>49,8</b>
Altezza totale H	Full height H	Gesamt Höhe H	Hauteur totale H	Altura total H	<b>H</b> <b>-</b>

Z	D <sub>e</sub>	D <sub>p</sub>	GS			GD			GT					
			cod.	d	D	cod.	d	D	cod.	d	D			
<b>*45</b>	282,5	273,10	GS 11045	118	45	2517	GD 11045	154	51	3020	GT 11045	160	51	3020
<b>*57</b>	355,4	345,81	GS 11057	124	45	2517	GD 11057	160	51	3020	GT 11057	160	51	3020
<b>*76</b>	469,9	460,99	GS 11076	124	45	2517	GD 11076	160	51	3020	GT 11076	160	51	3020
<b>*95</b>	585,1	576,17	GS 11095	124	45	2517	GD 11095	160	51	3020	GT 11095	160	76	3030
<b>*114</b>	700,6	691,36	GS 11114	124	64	2525	GD 11114	160	76	3030	GT 11114	160	76	3030

**Pignoni in ghisa per bussola / Taper bored cast iron sprockets**  
**Kettenräder aus Gusseisen für Spannbuchsen / Roues en fonte à moyeu amovible**  
**Rueda en fundicion para casquillos conicos**

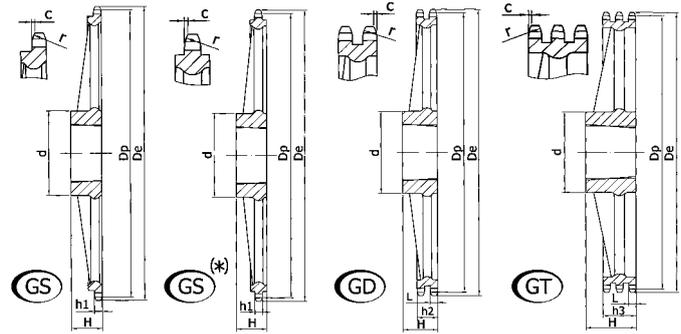

<b>Ghisa</b>	<b>Cast iron</b>	<b>Grauguss</b>	<b>Fonte</b>	<b>Hierro fundido</b>
<b>EN-GJL-250 UNI EN 1561</b>	<b>EN-GJL-250 UNI EN 1561</b>	<b>EN-GJL-250 UNI EN 1561</b>	<b>EN-GJL-250 UNI EN 1561</b>	<b>EN-GJL-250 UNI EN 1561</b>

**1" x 17,02 mm - 25,4 x 17,02 mm**

**16B - 1 - 2 - 3 - DIN 8187 ISO/R 606**

CATENA:	CHAIN:	KETTE:	CHAÎNE:	CADENA:	mm
Passo	Pitch	Teilung	Pas	Paso	<b>25,40</b>
Larghezza interna	Internal width	Innere Breite	Largeur interieure	Ancho interno	<b>17,02</b>
Rullo ø	Roller ø	Rollen ø	ø du rouleau	Rodillo ø	<b>15,88</b>
PIGNONE	SPROCKETS	KETTENRÄDER	PIGNONS	PIÑONES	mm
Raggio dente r	Tooth radius r	Radius r	Rayon de denture r	Radio diente r	<b>r 26,0</b>
Larghezza raggio C	Radius width C	Breite C	Largeur de rayon C	Ancho radio C	<b>C 2,5</b>
Largh. dente h <sub>1</sub>	Tooth width h <sub>1</sub>	Zahnbreite h <sub>1</sub>	Larg. de denture h <sub>1</sub>	Ancho diente h <sub>1</sub>	<b>h<sub>1</sub> 16,2</b>
Largh. dente L	Tooth width L	Zahnbreite L	Larg. de denture L	Ancho diente L	<b>L 15,8</b>
Largh. dente h <sub>2</sub>	Tooth width h <sub>2</sub>	Zahnbreite h <sub>2</sub>	Larg. de denture h <sub>2</sub>	Ancho diente h <sub>2</sub>	<b>h<sub>2</sub> 47,7</b>
Largh. dente h <sub>3</sub>	Tooth width h <sub>3</sub>	Zahnbreite h <sub>3</sub>	Larg. de denture h <sub>3</sub>	Ancho diente h <sub>3</sub>	<b>h<sub>3</sub> 79,6</b>
Altezza totale H	Full height H	Gesamt Höhe H	Hauteur totale H	Altura total H	<b>H -</b>

Z	D <sub>e</sub>	D <sub>p</sub>	GS			GD			GT					
			cod.	d	D	cod.	d	D	cod.	d	D			

**1"1/4 x 3/4" - 31,75 x 19,56 mm**

**20B - 1 - 2 - 3 - DIN 8187 ISO/R 606**

CATENA:	CHAIN:	KETTE:	CHAÎNE:	CADENA:	mm
Passo	Pitch	Teilung	Pas	Paso	<b>31,75</b>
Larghezza interna	Internal width	Innere Breite	Largeur interieure	Ancho interno	<b>19,56</b>
Rullo ø	Roller ø	Rollen ø	ø du rouleau	Rodillo ø	<b>19,05</b>
PIGNONE	SPROCKETS	KETTENRÄDER	PIGNONS	PIÑONES	mm
Raggio dente r	Tooth radius r	Radius r	Rayon de denture r	Radio diente r	<b>r 32,0</b>
Larghezza raggio C	Radius width C	Breite C	Largeur de rayon C	Ancho radio C	<b>C 3,5</b>
Largh. dente h <sub>1</sub>	Tooth width h <sub>1</sub>	Zahnbreite h <sub>1</sub>	Larg. de denture h <sub>1</sub>	Ancho diente h <sub>1</sub>	<b>h<sub>1</sub> 18,5</b>
Largh. dente L	Tooth width L	Zahnbreite L	Larg. de denture L	Ancho diente L	<b>L 18,2</b>
Largh. dente h <sub>2</sub>	Tooth width h <sub>2</sub>	Zahnbreite h <sub>2</sub>	Larg. de denture h <sub>2</sub>	Ancho diente h <sub>2</sub>	<b>h<sub>2</sub> 54,6</b>
Largh. dente h <sub>3</sub>	Tooth width h <sub>3</sub>	Zahnbreite h <sub>3</sub>	Larg. de denture h <sub>3</sub>	Ancho diente h <sub>3</sub>	<b>h<sub>3</sub> 91,0</b>
Altezza totale H	Full height H	Gesamt Höhe H	Hauteur totale H	Altura total H	<b>H -</b>

Z	D <sub>e</sub>	D <sub>p</sub>	GS			GD			GT					
			cod.	d	D	cod.	d	D	cod.	d	D			



**Pignoni in ghisa per bussola / Taper bored cast iron sprockets**  
**Kettenräder aus Gusseisen für Spannbuchsen / Roues en fonte à moyeu amovible**  
**Rueda en fundicion para casquillos conicos**

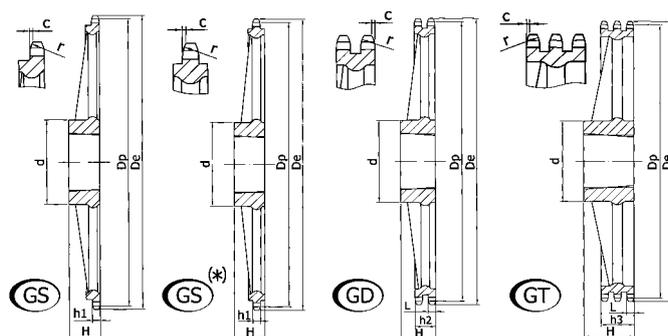

**Ghisa** EN-GJL-250 UNI EN 1561    **Cast iron** EN-GJL-250 UNI EN 1561    **Grauguss** EN-GJL-250 UNI EN 1561    **Fonte** EN-GJL-250 UNI EN 1561    **Hierro fundido** EN-GJL-250 UNI EN 1561

**1"1/2 x 1" - 38,1 x 25,4 mm**

**24B - 1 - 2 - 3 - DIN 8187 ISO/R 606**

CATENA:	CHAIN:	KETTE:	CHAÎNE:	CADENA:	mm
Passo	Pitch	Teilung	Pas	Paso	<b>38,1</b>
Larghezza interna	Internal width	Innere Breite	Largeur interieure	Ancho interno	<b>25,4</b>
Rullo ø	Roller ø	Rollen ø	ø du rouleau	Rodillo ø	<b>25,4</b>
PIGNONE	SPROCKETS	KETTENRÄDER	PIGNONS	PIÑONES	mm
Raggio dente r	Tooth radius r	Radius r	Rayon de denture r	Radio diente r	<b>r 38,0</b>
Larghezza raggio C	Radius width C	Breite C	Largeur de rayon C	Ancho radio C	<b>C 4,0</b>
Largh. dente h <sub>1</sub>	Tooth width h <sub>1</sub>	Zahnbreite h <sub>1</sub>	Larg. de denture h <sub>1</sub>	Ancho diente h <sub>1</sub>	<b>h<sub>1</sub> 24,1</b>
Largh. dente L	Tooth width L	Zahnbreite L	Larg. de denture L	Ancho diente L	<b>L 23,6</b>
Largh. dente h <sub>2</sub>	Tooth width h <sub>2</sub>	Zahnbreite h <sub>2</sub>	Larg. de denture h <sub>2</sub>	Ancho diente h <sub>2</sub>	<b>h<sub>2</sub> 72,0</b>
Largh. dente h <sub>3</sub>	Tooth width h <sub>3</sub>	Zahnbreite h <sub>3</sub>	Larg. de denture h <sub>3</sub>	Ancho diente h <sub>3</sub>	<b>h<sub>3</sub> 120,3</b>
Altezza totale H	Full height H	Gesamt Höhe H	Hauteur totale H	Altura total H	<b>H -</b>

Z	D <sub>e</sub>	D <sub>p</sub>	GS				GD				GT			
			cod.	d	D	per Bussola for Bush für Buchse pour Moyeux amovibles para Casquillos cónicos	cod.	d	D	per Bussola for Bush für Buchse pour Moyeux amovibles para Casquillos cónicos	cod.	d	D	per Bussola for Bush für Buchse pour Moyeux amovibles para Casquillos cónicos
* 30	379,5	364,50	GS 14030	160	76	3030	GD 14030	160	76	3030	GT 14030	178	89	3535
* 38	476,2	461,39	GS 14038	160	76	3030	GD 14038	175	89	3535	GT 14038	216	102	4040
* 45	561,2	546,20	GS 14045	160	76	3030	GD 14045	175	89	3535	GT 14045	216	102	4040
* 57	706,5	691,63	GS 14057	160	76	3030	GD 14057	175	89	3535	GT 14057	240	102	4040
* 76	936,9	921,98	GS 14076	160	76	3030	GD 14076	240	102	4040	GT 14076	260	114	4545
* 95	1167,3	1152,33	GS 14095	260	114	4545	GD 14095	278	127	5050	GT 14095	278	127	5050

**Corone per trasportatori ed elevatori**  
**Plate wheels for chain conveyors and chain elevators**  
**Kettenradscheiben für Transport-und Förderketten**  
**Disques pour transporteurs et elevateurs**  
**Discos para cadena de transportadores y elevadores**

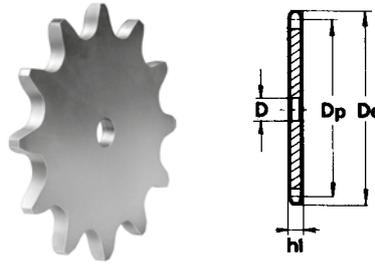

**Rullo    Roller    Rollen    Rouleau    Rodillo**

**P. 50** **25 - 28 - 31**

CATENA:	CHAIN:	KETTE:	CHAÎNE:	CADENA:	mm
Larghezza interna	Internal width	Innere Breite	Largeur interieure	Ancho interno	<b>11,5 - 15,0 - 15,0</b>
Rullo ø	Roller ø	Rollen ø	ø du rouleau	Rodillo ø	<b>25,0 - 28,0 - 31,0</b>
Spessore corona h <sub>1</sub>	Tooth width h <sub>1</sub>	Zahnbreite h <sub>1</sub>	Larg. denture h <sub>1</sub>	Ancho dente h <sub>1</sub>	<b>10,5 - 13,5 - 13,5</b>

Z	R 25				R 28				R 31			
	cod.	D <sub>e</sub>	D <sub>p</sub>	D	cod.	D <sub>e</sub>	D <sub>p</sub>	D	cod.	D <sub>e</sub>	D <sub>p</sub>	D
6	CE 17006	115,0	100,00	20	CE 18006	115,0	100,00	20	CE 19006	115,0	100,00	20
7	CE 17007	132,0	115,24	20	CE 18007	132,0	115,24	20	CE 19007	132,0	115,24	20
8	CE 17008	149,0	130,65	20	CE 18008	149,0	130,65	20	CE 19008	149,0	130,65	20
9	CE 17009	165,0	146,20	20	CE 18009	165,0	146,20	20	CE 19009	165,0	146,20	20
10	CE 17010	180,0	161,80	20	CE 18010	180,0	161,80	20	CE 19010	180,0	161,80	20
11	CE 17011	197,0	177,50	25	CE 18011	197,0	177,50	25	CE 19011	197,0	177,50	25
12	CE 17012	212,0	193,20	25	CE 18012	212,0	193,20	25	CE 19012	212,0	193,20	25
13	CE 17013	228,0	208,95	25	CE 18013	228,0	208,95	25	CE 19013	228,0	208,95	25
14	CE 17014	244,0	224,70	25	CE 18014	244,0	224,70	25	CE 19014	244,0	224,70	25
15	CE 17015	260,0	240,45	25	CE 18015	260,0	240,45	25	CE 19015	260,0	240,45	25
16	CE 17016	276,0	256,30	30	CE 18016	276,0	256,30	30	CE 19016	276,0	256,30	30
17	CE 17017	292,0	272,11	30	CE 18017	292,0	272,11	30	CE 19017	292,0	272,11	30
18	CE 17018	307,0	287,95	30	CE 18018	307,0	287,95	30	CE 19018	307,0	287,95	30
19	CE 17019	322,0	303,80	30	CE 18019	322,0	303,80	30	CE 19019	322,0	303,80	30
20	CE 17020	339,0	319,60	30	CE 18020	339,0	319,60	30	CE 19020	339,0	319,60	30
21	CE 17021	355,0	335,45	30	CE 18021	355,0	335,45	30	CE 19021	355,0	335,45	30
22	CE 17022	371,0	351,35	30	CE 18022	371,0	351,35	30	CE 19022	371,0	351,35	30
23	CE 17023	387,0	367,20	30	CE 18023	387,0	367,20	30	CE 19023	387,0	367,20	30
24	CE 17024	403,0	383,05	30	CE 18024	403,0	383,05	30	CE 19024	403,0	383,05	30
25	CE 17025	418,0	398,95	30	CE 18025	418,0	398,95	30	CE 19025	418,0	398,95	30
26	CE 17026	434,0	414,80	30	CE 18026	434,0	414,80	30	CE 19026	434,0	414,80	30
27	CE 17027	450,0	430,70	30	CE 18027	450,0	430,70	30	CE 19027	450,0	430,70	30
28	CE 17028	466,0	446,55	30	CE 18028	466,0	446,55	30	CE 19028	466,0	446,55	30
29	CE 17029	482,0	462,45	30	CE 18029	482,0	462,45	30	CE 19029	482,0	462,45	30
30	CE 17030	498,0	478,35	30	CE 18030	498,0	478,35	30	CE 19030	498,0	478,35	30
31	CE 17031	514,0	494,25	30								
32	CE 17032	530,0	510,10	30					CE 19032	530,0	510,10	30
35	CE 17035	577,0	557,80	30	CE 18035	577,0	557,80	30	CE 19035	577,0	557,80	30
36	CE 17036	593,0	573,70	30								
38	CE 17038	625,0	605,45	30	CE 18038	625,0	605,45	30	CE 19038	625,0	605,45	30

**Corone per trasportatori ed elevatori**  
**Plate wheels for chain conveyors and chain elevators**  
**Kettenradscheiben für Transport-und Förderketten**  
**Disques pour transporteurs et elevateurs**  
**Discos para cadena de transportadores y elevadores**

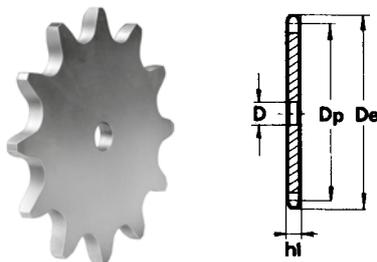

**Rullo**                      **Roller**                      **Rollen**                      **Rouleau**                      **Rodillo**

**P. 75** **25 - 31**

CATENA:	CHAIN:	KETTE:	CHAÎNE:	CADENA:	mm
Larghezza interna	Internal width	Innere Breite	Largeur interieure	Ancho interno	<b>11,5 - 15,0</b>
Rullo ø	Roller ø	Rollen ø	ø du rouleau	Rodillo ø	<b>25,0 - 31,0</b>
Spessore corona h <sub>1</sub>	Tooth width h <sub>1</sub>	Zahnbreite h <sub>1</sub>	Larg. denture h <sub>1</sub>	Ancho dente h <sub>1</sub>	<b>10,5 - 13,5</b>

Z	R 25				R 31				Z	R 25				R 31			
	cod.	D <sub>e</sub>	D <sub>p</sub>	D	cod.	D <sub>e</sub>	D <sub>p</sub>	D		cod.	D <sub>e</sub>	D <sub>p</sub>	D	cod.	D <sub>e</sub>	D <sub>p</sub>	D
6	CE 20006	165,0	150,00	25	CE 22006	168,0	150,00	25	19	CE 20019	471,0	455,70	30	CE 22019	475,0	455,70	30
7	CE 20007	188,0	172,86	25	CE 22007	192,0	172,86	25	20	CE 20020	495,0	479,40	30	CE 22020	499,0	479,40	30
8	CE 20008	211,0	195,98	25	CE 22008	215,0	195,98	25	21	CE 20021	519,0	503,17	30	CE 22021	523,0	503,17	30
9	CE 20009	234,0	219,30	25	CE 22009	238,0	219,30	25	22	CE 20022	543,0	527,02	30	CE 22022	547,0	527,02	30
10	CE 20010	258,0	242,70	30	CE 22010	261,0	242,70	30	23	CE 20023	566,0	550,80	30	CE 22023	570,0	550,80	30
11	CE 20011	282,0	266,25	30	CE 22011	286,0	266,25	30	24	CE 20024	590,0	574,57	30	CE 22024	594,0	574,57	30
12	CE 20012	305,0	289,80	30	CE 22012	309,0	289,80	30	25	CE 20025	614,0	598,42	30	CE 22025	618,0	598,42	30
13	CE 20013	329,0	313,42	30	CE 22013	333,0	313,42	30	26	CE 20026	638,0	622,20	30				
14	CE 20014	353,0	337,05	30	CE 22014	357,0	337,05	30	27	CE 20027	622,0	646,05	30				
15	CE 20015	376,0	360,72	30	CE 22015	380,0	360,72	30	28	CE 20028	685,0	669,82	30				
16	CE 20016	400,0	384,45	30	CE 22016	404,0	384,45	30	29	CE 20029	709,0	693,68	30				
17	CE 20017	424,0	408,16	30	CE 22017	428,0	408,16	30	30	CE 20030	733,0	717,52	30				
18	CE 20018	447,0	431,92	30	CE 22018	451,0	431,92	30									

**P. 100** **25 - 31 - 40**

CATENA:	CHAIN:	KETTE:	CHAÎNE:	CADENA:	mm
Larghezza interna	Internal width	Innere Breite	Largeur interieure	Ancho interno	<b>11,5 - 15,0 - 22,0</b>
Rullo ø	Roller ø	Rollen ø	ø du rouleau	Rodillo ø	<b>25,0 - 31,0 - 40,0</b>
Spessore corona h <sub>1</sub>	Tooth width h <sub>1</sub>	Zahnbreite h <sub>1</sub>	Larg. denture h <sub>1</sub>	Ancho dente h <sub>1</sub>	<b>10,5 - 13,5 - 20,0</b>

Z	R 25				R 31				R 40			
	cod.	D <sub>e</sub>	D <sub>p</sub>	D	cod.	D <sub>e</sub>	D <sub>p</sub>	D	cod.	D <sub>e</sub>	D <sub>p</sub>	D
6	CE 23006	214,0	200,00	25	CE 25006	218,0	200,00	25	CE 27006	220,0	200,00	25
7	CE 23007	245,0	230,48	25	CE 25007	249,0	230,48	25	CE 27007	251,0	230,48	25
8	CE 23008	276,0	261,31	30	CE 25008	280,0	261,31	30	CE 27008	283,0	261,31	30
9	CE 23009	307,0	292,40	30	CE 25009	311,0	292,40	30	CE 27009	314,0	292,40	30
10	CE 23010	338,0	323,61	30	CE 25010	342,0	323,61	30	CE 27010	345,0	323,61	30
11	CE 23011	371,0	354,95	30	CE 25011	375,0	354,95	30	CE 27011	378,0	354,95	30
12	CE 23012	402,0	386,40	30	CE 25012	406,0	386,40	30	CE 27012	409,0	386,40	30
13	CE 23013	433,0	417,90	30	CE 25013	437,0	417,90	30	CE 27013	441,0	417,90	30
14	CE 23014	465,0	449,40	30	CE 25014	469,0	449,90	30	CE 27014	473,0	449,40	30
15	CE 23015	496,0	480,97	30	CE 25015	500,0	480,97	30	CE 27015	504,0	480,97	30
16	CE 23016	528,0	512,60	30	CE 25016	532,0	512,60	30	CE 27016	536,0	512,60	30
17	CE 23017	560,0	544,22	30	CE 25017	564,0	544,22	30	CE 27017	568,0	544,22	30
18	CE 23018	591,0	575,90	30	CE 25018	595,0	575,90	30	CE 27018	599,0	575,90	30
19	CE 23019	623,0	607,55	30	CE 25019	627,0	607,55	30	CE 27019	631,0	607,55	30
20	CE 23020	655,0	639,20	30	CE 25020	659,0	639,20	30	CE 27020	663,0	639,20	30
21	CE 23021	686,0	670,95	30	CE 25021	690,0	670,95	21				
22	CE 23022	718,0	702,70	30	CE 25022	722,0	702,70	30				
23	CE 23023	750,0	734,40	30	CE 25023	754,0	734,40	30				
24	CE 23024	782,0	766,10	30	CE 25024	786,0	766,10	30				
25	CE 23025	813,0	797,90	30	CE 25025	817,0	797,90	30				

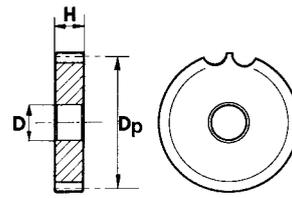

**P. 1"1/2 DIN 8153**

**Materiale C 45 E**  
**UNI EN 10083-1**

**Material C 45 E**  
**UNI EN 10083-1**

**Werkstoff C 45 E**  
**UNI EN 10083-1**

**Matière C 45 E**  
**UNI EN 10083-1**

**Material C 45 E**  
**UNI EN 10083-1**

Z	cod.	D <sub>p</sub>	D	H	Z	cod.	D <sub>p</sub>	D	H
13	RC 14013	78,98	15	43,5	23	RC 14023	141,22	20	43,5
15	RC 14015	93,67	15	43,5	25	RC 14025	153,21	20	43,5
17	RC 14017	105,47	20	43,5	27	RC 14027	165,20	20	43,5
19	RC 14019	117,34	20	43,5	29	RC 14029	177,24	20	43,5
21	RC 14021	129,26	20	43,5	31	RC 14031	189,29	20	43,5

**Pignoni tendicatena completi di cuscinetto / Ball bearing idler sprockets**  
**Kettenspannräder mit Kugellager / Pignons tendeurs complets avec roulement**  
**Piñones tensores completos con cojinete**

I ns.pignoni tendicatena sono completi di cuscinetto, pronti al montaggio in particolari punti di tensione oppure di rinvio. L'accurata lavorazione ed il montaggio stabile su di un cuscinetto a sfere, a doppio schermo di protezione, permettono una maggiore resistenza ai carichi e all'usura. L'anello centrale del cuscinetto "allungato", permette un facile montaggio su macchinari speciali di ogni tipo.

Our idler sprockets are supplied complete with bearings, ready to be fitted at the relevant tension or driving gear points. The accurate machining and stable assembly on a ball bearing, with double protection, provides greater resistance to loads and wear. The central "extended" ring on bearing, allows easy assembly on all types of special machinery.

Unsere Kettenspannräder werden komplett mit Lager geliefert und sind für den Einbau an besonderen Spannungs- oder Vorgelegepunkten geeignet. Die sorgfältige Verarbeitung und die stabile Montage auf einem Kugellager mit doppelter Schutzblende sorgen für eine höhere Last und Verschleißbeständigkeit geeignet. Der Mittelring des "verlängerten" Lagers erlaubt den einfachen Einbau an Spezialmaschinen aller Art.

Nos pignons tendeurs sont équipés de roulements et conviennent au montage en cas de points de tension particulières ou de renvoi. L'usinage soigné et le montage stable sur roulements à billes, à double écran de protection confèrent à nos produits une résistance accrue aux charges et à l'usage.

Nuestros piñones tensocadena están provistos de cojinete y se pueden montar en puntos de tensión o reenvío especiales. Gracias a las características de fabricación y al montaje estable en cojinetes de bolas con doble escudo de protección, ofrecen mayor resistencia de carga y más durabilidad. El anillo central del cojinete "alargado" facilita el montaje en todo tipo de maquinarias especiales.

**Materiale C 45 E**  
**UNI EN 10083-1**

**Material C 45 E**  
**UNI EN 10083-1**

**Werkstoff C 45 E**  
**UNI EN 10083-1**

**Matière C 45 E**  
**UNI EN 10083-1**

**Material C 45 E**  
**UNI EN 10083-1**

Z	cod.	P.	D <sub>e</sub>	D <sub>p</sub>	B <sub>1</sub>	A	D	F	H	J	cuscinetto/bearing Kugellager/roulement/cojinete
23	PC 04023	8x1/8"	62,0	58,75	2,8	7,0	16 <sup>+0,26 +0,13</sup>	40	18,3	12	203 KRR
20	PC 05020	3/8"x7/32"	64,3	60,89	5,3	7,0	16 <sup>+0,26 +0,13</sup>	40	18,3	12	203 KRR
21	PC 05021	3/8"x7/32"	68,0	63,91	5,3	7,0	16 <sup>+0,26 +0,13</sup>	40	18,3	12	203 KRR
18	PC 06018	1/2"x1/8"	78,9	73,14	3,0	7,0	16 <sup>+0,26 +0,13</sup>	40	18,3	12	203 KRR
16	PC 07016	1/2"x3/16"	70,9	65,10	4,5	7,0	16 <sup>+0,26 +0,13</sup>	40	18,3	12	203 KRR
18	PC 07018	1/2"x3/16"	78,9	73,14	4,5	7,0	16 <sup>+0,26 +0,13</sup>	40	18,3	12	203 KRR
14	PC 09014	1/2"x5/16"	61,8	57,07	7,2	7,2	16 <sup>+0,26 +0,13</sup>	40	18,3	12	203 KRR
15	PC 09015	1/2"x5/16"	65,5	61,09	7,2	7,2	16 <sup>+0,26 +0,13</sup>	40	18,3	12	203 KRR
16	PC 09016	1/2"x5/16"	69,5	65,10	7,2	7,2	16 <sup>+0,26 +0,13</sup>	40	18,3	12	203 KRR
18	PC 09018	1/2"x5/16"	77,8	73,14	7,2	7,2	16 <sup>+0,26 +0,13</sup>	40	18,3	12	203 KRR
20	PC 09020	1/2"x5/16"	85,8	81,19	7,2	7,2	16 <sup>+0,26 +0,13</sup>	40	18,3	12	203 KRR
21	PC 09021	1/2"x5/16"	89,7	85,22	7,2	7,2	16 <sup>+0,26 +0,13</sup>	40	18,3	12	203 KRR
13	PC 10013	5/8"x3/8"	73,0	66,32	9,1	9,1	16 <sup>+0,26 +0,13</sup>	40	18,3	12	203 KRR
14	PC 10014	5/8"x3/8"	78,0	71,34	9,1	9,1	16 <sup>+0,26 +0,13</sup>	40	18,3	12	203 KRR
15	PC 10015	5/8"x3/8"	83,0	76,36	9,1	9,1	16 <sup>+0,26 +0,13</sup>	40	18,3	12	203 KRR
16	PC 10016	5/8"x3/8"	88,0	81,37	9,1	9,1	16 <sup>+0,26 +0,13</sup>	40	18,3	12	203 KRR
17	PC 10017	5/8"x3/8"	93,0	86,30	9,1	9,1	16 <sup>+0,26 +0,13</sup>	40	18,3	12	203 KRR
18	PC 10018	5/8"x3/8"	98,3	91,42	9,1	9,1	16 <sup>+0,26 +0,13</sup>	40	18,3	12	203 KRR
21	PC 10021	5/8"x3/8"	113,4	106,52	9,1	9,1	16 <sup>+0,26 +0,13</sup>	40	18,3	12	203 KRR
12	PC 11012	3/4"x7/16"	81,5	73,60	11,1	11,1	16 <sup>+0,26 +0,13</sup>	40	18,3	12	203 KRR
13	PC 11013	3/4"x7/16"	87,5	79,59	11,1	11,1	16 <sup>+0,26 +0,13</sup>	40	18,3	12	203 KRR
15	PC 11015	3/4"x7/16"	99,8	91,63	11,1	11,1	16 <sup>+0,26 +0,13</sup>	40	18,3	12	203 KRR
16	PC 11016	3/4"x7/16"	105,5	97,65	11,1	11,1	16 <sup>+0,26 +0,13</sup>	40	18,3	12	203 KRR
12	PC 12012	1"x17,02"	109,0	98,14	16,2	16,2	20 <sup>+0,1 +0</sup>	47	17,7	14	204 KRR
15	PC 12015	1"x17,02"	133,0	122,17	16,2	16,2	20 <sup>+0,1 +0</sup>	47	17,7	14	204 KRR
17	PC 12017	1"x17,02"	149,0	138,24	16,2	16,2	20 <sup>+0,1 +0</sup>	47	17,7	14	204 KRR
13	PC 13013	1"1/4x3/4"	147,8	132,65	18,5	18,5	25 <sup>+0,1 +0</sup>	52	21,0	15	205 KRR

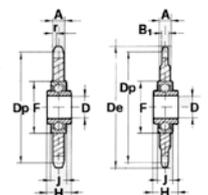
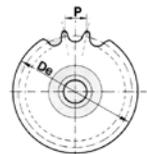
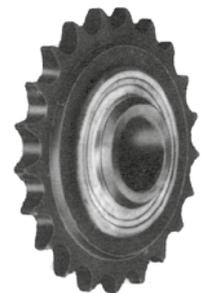

**Pignoni per bussole coniche / Taper bored sprockets**  
**Kettenräder für Spannbuchsen / Pignons à moyeu amovible**  
**Piñones para casquillos cónicos**



**Versione (\*) / Type (\*)**  
**Typ (\*) / Tipo (\*)**

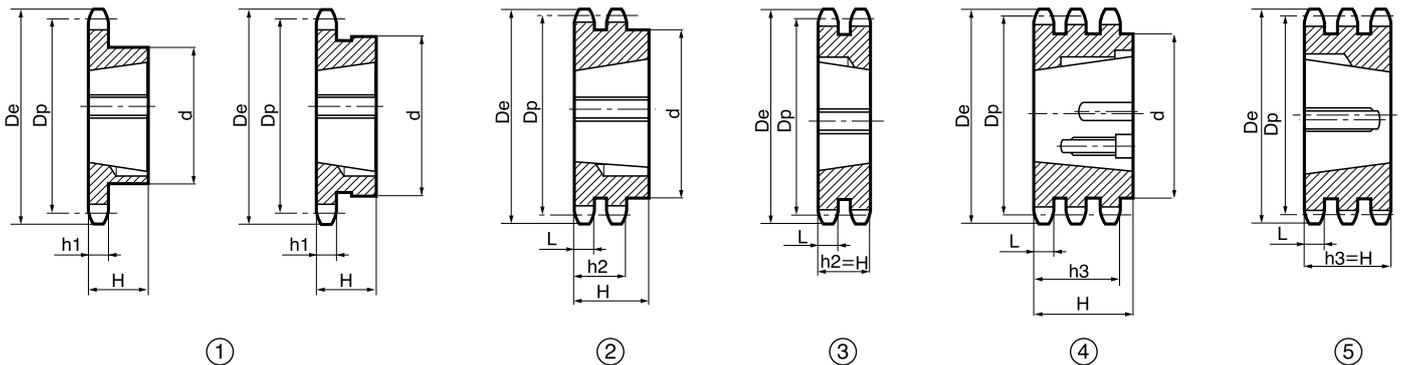

**3/8" x 7/32" - 9,525 x 5,72 mm**

**06B - 1-2-3 - DIN 8187 - ISO/R 606**

CATENA:	CHAIN:	KETTE:	CHAÎNE:	CADENA:	ISO mm
Passo	Pitch	Teilung	Pas	Paso	<b>9,525</b>
Larghezza interna	Internal width	Innere Breite	Largeur interieure	Ancho interno	<b>5,720</b>
Rullo ø	Roller ø	Rollen ø	ø du rouleau	Rodillo ø	<b>6,350</b>

PIGNONE	SPROCKETS	KETTENRÄDER	PIGNONS	PIÑONES	ISO mm
Raggio dente r	Tooth radius r	Radius r	Rayon de denture r	Radio diente r	<b>r 10,0</b>
Larghezza raggio C	Radius width C	Breite C	Largeur de rayon C	Ancho radio C	<b>C 1,0</b>
Largh. dente h <sub>1</sub>	Tooth width h <sub>1</sub>	Zahnbreite h <sub>1</sub>	Larg. de denture h <sub>1</sub>	Ancho diente h <sub>1</sub>	<b>h<sub>1</sub> 5,3</b>
Largh. dente L	Tooth width L	Zahnbreite L	Larg. de denture L	Ancho diente L	<b>L 5,2</b>
Largh. dente h <sub>2</sub>	Tooth width h <sub>2</sub>	Zahnbreite h <sub>2</sub>	Larg. de denture h <sub>2</sub>	Ancho diente h <sub>2</sub>	<b>h<sub>2</sub> 15,4</b>
Largh. dente h <sub>3</sub>	Tooth width h <sub>3</sub>	Zahnbreite h <sub>3</sub>	Larg. de denture h <sub>3</sub>	Ancho diente h <sub>3</sub>	<b>h<sub>3</sub> 25,6</b>

**Acciaio                      Steel                      Stahl                      Acier                      Acero = C 45 E - UNI EN 10083-1**

Z	D <sub>e</sub>	D <sub>p</sub>	TS				TD				TT						
			cod.	d	H	per Bussola for Bush für Buchse pour Moyeux amovibles para Casquillos cónicos	Esecuz. tipo Type Typ Type Tpo	cod.	d	H	per Bussola for Bush für Buchse pour Moyeux amovibles para Casquillos cónicos	Esecuz. tipo Type Typ Type Tpo	cod.	d	H	per Bussola for Bush für Buchse pour Moyeux amovibles para Casquillos cónicos	Esecuz. tipo Type Typ Type Tpo
17	55,3	51,83	TS 05017	45*	22	1008	1	TD 05017	42	22	1008	2	TT 05017	-	25,6	1008	5
18	58,3	54,85	TS 05018	45*	22	1008	1	TD 05018	43	22	1008	2					
19	61,3	57,87	TS 05019	45	22	1008	1	TD 05019	46	22	1008	2	TT 05019	-	25,6	1008	5
20	64,3	60,89	TS 05020	46	22	1008	1	TD 05020	48	22	1008	2					
21	68,0	63,91	TS 05021	46	22	1008	1	TD 05021	49	22	1008	2	TT 05021	-	25,6	1008	5
22	71,0	66,93	TS 05022	50	22	1108	1	TD 05022	52	22	1108	2					
23	73,5	69,95	TS 05023	63*	25	1210	1	TD 05023	59	25	1210	2	TT 05023	-	25,6	1210	5
24	77,0	72,97	TS 05024	63	25	1210	1	TD 05024	61	25	1210	2					
25	80,0	76,02	TS 05025	63	25	1210	1	TD 05025	64	25	1210	2	TT 05025	-	25,6	1210	5
26	83,0	79,02	TS 05026	63	25	1210	1	TD 05026	65	25	1210	2					
27	86,0	82,02	TS 05027	63	25	1210	1	TD 05027	70	25	1210	2	TT 05027	-	25,6	1210	5
28	89,0	85,07	TS 05028	63	25	1210	1	TD 05028	70	25	1210	2					
30	94,7	91,12	TS 05030	63	25	1210	1	TD 05030	75	25	1210	2	TT 05030	79	38,0	1615	4
38	119,5	115,35	TS 05038	70	25	1210	1	TD 05038	80	25	1610	2	TT 05038	90	38,0	1615	4
45	140,7	136,55	TS 05045	70	25	1210	1	TD 05045	80	25	1610	2					
57	176,9	172,91	TS 05057	70	25	1210	1	TD 05057	80	25	1610	2					
76	234,9	230,49	TS 05076	70	25	1210	1	TD 05076	80	25	1610	2					
95	292,5	288,08	TS 05095	80	25	1210	1	TD 05095	90	25	1610	2					
114	349,5	345,68	TS 05114	80	38	1215	1	TD 05114	95	38	1615	2					

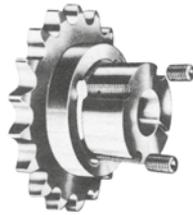

**Versione (\*) / Type (\*)**  
**Typ (\*) / Tipo (\*)**

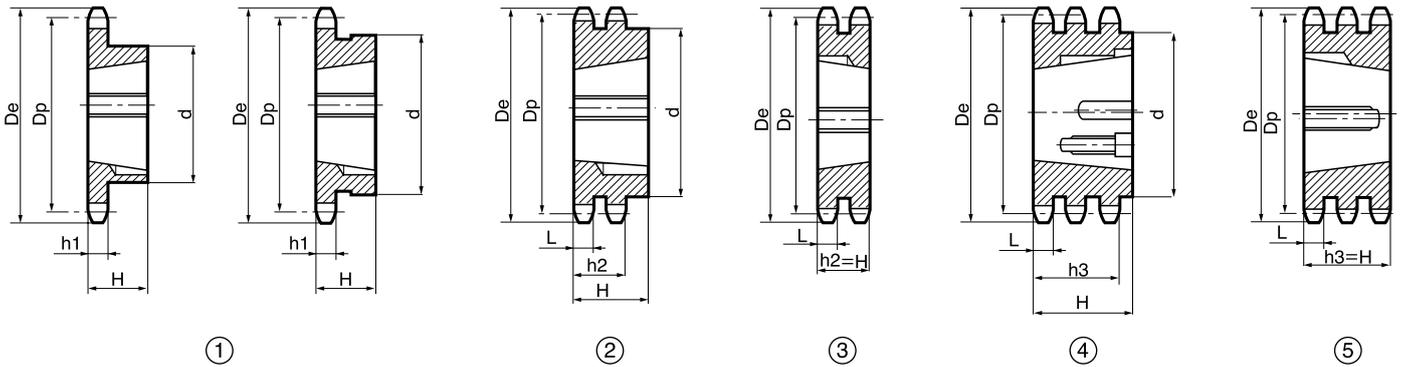

**1/2" x 5/16" - 12,7 x 7,75 mm**

**08B - 1-2-3 - DIN 8187 - ISO/R 606**

CATENA:	CHAIN:	KETTE:	CHAÎNE:	CADENA:	ISO mm
Passo	Pitch	Teilung	Pas	Paso	<b>12,07</b>
Larghezza interna	Internal width	Innere Breite	Largeur interieure	Ancho interno	<b>7,75</b>
Rullo ø	Roller ø	Rollen ø	ø du rouleau	Rodillo ø	<b>8,51</b>

PIGNONE	SPROCKETS	KETTENRÄDER	PIGNONS	PIÑONES	ISO mm
Raggio dente r	Tooth radius r	Radius r	Rayon de denture r	Radio diente r	<b>r 13,0</b>
Larghezza raggio C	Radius width C	Breite C	Largeur de rayon C	Ancho radio C	<b>C 1,3</b>
Largh. dente h <sub>1</sub>	Tooth width h <sub>1</sub>	Zahnbreite h <sub>1</sub>	Larg. de denture h <sub>1</sub>	Ancho diente h <sub>1</sub>	<b>h<sub>1</sub> 7,2</b>
Largh. dente L	Tooth width L	Zahnbreite L	Larg. de denture L	Ancho diente L	<b>L 7,0</b>
Largh. dente h <sub>2</sub>	Tooth width h <sub>2</sub>	Zahnbreite h <sub>2</sub>	Larg. de denture h <sub>2</sub>	Ancho diente h <sub>2</sub>	<b>h<sub>2</sub> 21,0</b>
Largh. dente h <sub>3</sub>	Tooth width h <sub>3</sub>	Zahnbreite h <sub>3</sub>	Larg. de denture h <sub>3</sub>	Ancho diente h <sub>3</sub>	<b>h<sub>3</sub> 34,9</b>

**Acciaio                      Steel                      Stahl                      Acier                      Acero = C45E-UNIEN 10083-1**

Z	D <sub>e</sub>	D <sub>p</sub>	TS				TD				TT						
			cod.	d	H	per Bussola for Bush für Buchse pour Moyeux amovibles para Casquillos cónicos	Esecuz. tipo Type Typ Tipo	cod.	d	H	per Bussola for Bush für Buchse pour Moyeux amovibles para Casquillos cónicos	Esecuz. tipo Type Typ Tipo	cod.	d	H	per Bussola for Bush für Buchse pour Moyeux amovibles para Casquillos cónicos	Esecuz. tipo Type Typ Tipo
15	65,5	61,90	TS 09015	45	22	1008	1	TD 09015	46	22	1008	2	TT 09015	-	34,9	1008	5
16	69,5	65,10	TS 09016	50	22	1108	1	TD 09016	50	22	1108	2					
17	73,6	69,11	TS 09017	60*	25	1210	1	TD 09017	56	25	1210	2	TT 09017	-	34,9	1210	5
18	77,8	73,14	TS 09018	60*	25	1210	1	TD 09018	60	25	1210	2					
19	81,7	77,16	TS 09019	63	25	1210	1	TD 09019	62	25	1210	2	TT 09019	-	34,9	1210	5
20	85,8	81,19	TS 09020	71*	25	1610	1	TD 09020	66	25	1610	2					
21	89,7	85,22	TS 09021	71	25	1610	1	TD 05021	70	25	1610	2	TT 09021	-	34,9	1610	5
22	93,8	89,24	TS 09022	71	25	1610	1	TD 09022	76	25	1610	2					
23	98,2	93,27	TS 09023	76	25	1610	1	TD 09023	79	25	1610	2	TT 09023	-	34,9	1610	5
24	101,8	97,29	TS 09024	76	25	1610	1	TD 09024	84	25	1610	2					
25	105,8	101,33	TS 09025	76	25	1610	1	TD 09025	87	32	2012	2	TT 09025	-	34,9	2012	5
26	110,0	105,36	TS 09026	76	25	1610	1	TD 09026	87	32	2012	2					
27	114,4	109,40	TS 09027	76	25	1610	1	TD 09027	87	32	2012	2	TT 09027	-	34,9	2012	5
28	118,0	113,42	TS 09028	90	32	2012	1	TD 09028	87	32	2012	2					
30	126,1	121,50	TS 09030	90	32	2012	1	TD 09030	87	32	2012	2	TT 09030	-	34,9	2012	5
38	158,6	153,80	TS 09038	90	32	2012	1	TD 09038	100	32	2012	2	TT 09038	-	34,9	2012	5
45	188,0	182,07	TS 09045	100	32	2012	1	TD 09045	100	32	2012	2					
57	236,4	230,54	TS 09057	100	32	2012	1	TD 09057	100	32	2012	2					
76	313,3	307,33	TS 09076	100	32	2012	1	TD 09076	100	32	2012	2					
95	390,1	384,11	TS 09095	100	32	2012	1	TD 09095	100	32	2012	2					
114	466,9	460,90	TS 09114	110	45	2517	1	TD 09114	110	45	2517	2					

**Pignoni per bussole coniche / Taper bored sprockets**  
**Kettenräder für Spannbuchsen / Pignons à moyeu amovible**  
**Piñones para casquillos cónicos**

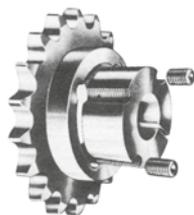

Versione (\*) / Type (\*)  
Typ (\*) / Tipo (\*)

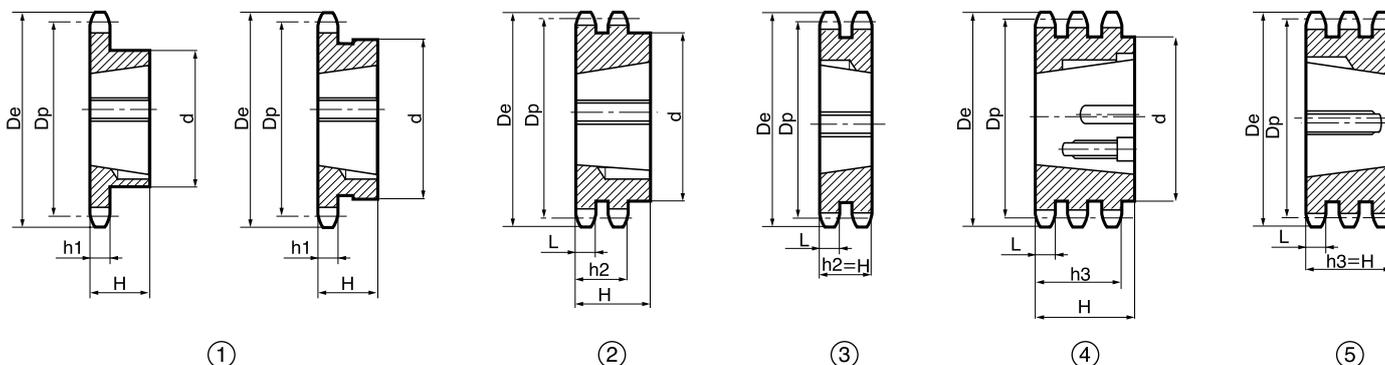

**5/8" x 3/8" - 15,875 x 9,65 mm**

**10B - 1-2-3 - DIN 8187 - ISO/R 606**

<b>CATENA:</b>	<b>CHAIN:</b>	<b>KETTE:</b>	<b>CHAÎNE:</b>	<b>CADENA:</b>	<b>ISO mm</b>
Passo	Pitch	Teilung	Pas	Paso	<b>15,875</b>
Larghezza interna	Internal width	Innere Breite	Largeur interieure	Ancho interno	<b>9,650</b>
Rullo ø	Roller ø	Rollen ø	ø du rouleau	Rodillo ø	<b>10,160</b>

<b>PIGNONE</b>	<b>SPROCKETS</b>	<b>KETTENRÄDER</b>	<b>PIGNONS</b>	<b>PIÑONES</b>	<b>ISO mm</b>
Raggio dente r	Tooth radius r	Radius r	Rayon de denture r	Radio diente r	<b>r 16,0</b>
Larghezza raggio C	Radius width C	Breite C	Largeur de rayon C	Ancho radio C	<b>C 1,6</b>
Largh. dente h <sub>1</sub>	Tooth width h <sub>1</sub>	Zahnbreite h <sub>1</sub>	Larg. de denture h <sub>1</sub>	Ancho diente h <sub>1</sub>	<b>h<sub>1</sub> 9,1</b>
Largh. dente L	Tooth width L	Zahnbreite L	Larg. de denture L	Ancho diente L	<b>L 9,0</b>
Largh. dente h <sub>2</sub>	Tooth width h <sub>2</sub>	Zahnbreite h <sub>2</sub>	Larg. de denture h <sub>2</sub>	Ancho diente h <sub>2</sub>	<b>h<sub>2</sub> 25,5</b>
Largh. dente h <sub>3</sub>	Tooth width h <sub>3</sub>	Zahnbreite h <sub>3</sub>	Larg. de denture h <sub>3</sub>	Ancho diente h <sub>3</sub>	<b>h<sub>3</sub> 42,1</b>

**Acciaio Steel Stahl Acier Acero = C 45 E - UNI EN 10083-1**

Z	D <sub>e</sub>	D <sub>p</sub>	TS				TD				TT							
			cod.	d	H	per Bussola for Bush für Buchse pour Moyeux amovibles para Casquillos cónicos	Esecuz. tipo Type Typ Type Tpo	cod.	d	H	per Bussola for Bush für Buchse pour Moyeux amovibles para Casquillos cónicos	Esecuz. tipo Type Typ Type Tpo	cod.	d	H	per Bussola for Bush für Buchse pour Moyeux amovibles para Casquillos cónicos	Esecuz. tipo Type Typ Type Tpo	
13	73,0	66,32	TS 10013	47	22	1008	1	TD 10013	-	25,5	1108	3						
14	78,0	71,34	TS 10014	52	22	1108	1											
15	83,0	76,36	TS 10015	60	25	1210	1	TD 10015	-	25,5	1210	3	TT 10015	-	42,1	1210	5	
16	88,0	81,37	TS 10016	70*	25	1610	1											
17	93,0	86,36	TS 10017	71*	25	1610	1	TD 10017	-	25,5	1610	3	TT 10017	-	42,1	1210	5	
18	98,3	91,42	TS 10018	75	25	1610	1											
19	103,3	96,45	TS 10019	75	25	1610	1	TD 10019	-	25,5	1610	3	TT 10019	-	42,1	1615	5	
20	108,4	101,49	TS 10020	75	25	1610	1	TD 10020	-	25,5	1610	3						
21	113,4	106,52	TS 10021	76	25	1610	1	TD 10021	-	25,5	1610	3	TT 10021	-	42,1	1615	5	
22	118,0	111,55	TS 10022	76	25	1610	1	TD 10022	-	25,5	1610	3						
23	123,4	116,58	TS 10023	76	25	1610	1	TD 10023	-	25,5	1610	3	TT 10023	-	42,1	2012	5	
24	128,3	121,62	TS 10024	90	32	2012	1											
25	134,0	126,66	TS 10025	90	32	2012	1	TD 10025	90	32,0	2012	2	TT 10025	105	45,0	2517	4	
26	139,0	131,70	TS 10026	90	32	2012	1											
27	144,0	136,75	TS 10027	90	32	2012	1	TD 10027	90	32,0	2012	2	TT 10027	110	45,0	2517	4	
28	148,7	141,78	TS 10028	90	32	2012	1											
30	158,8	151,87	TS 10030	90	32	2012	1	TD 10030	90	32,0	2012	2	TT 10030	120	45,0	2517	4	
38	199,2	192,24	TS 10038	100	32	2012	1	TD 10038	108	45,0	2517	2						
45	235,0	227,58	TS 10045	100	32	2012	1											
57	296,0	288,18	TS 10057	100	32	2012	1											
76	392,1	384,16	TS 10076	100	32	2012	1											
95	488,5	480,14	TS 10095	110	45	2517	1											
114	584,1	576,13	TS 10114	110	45	2517	1											

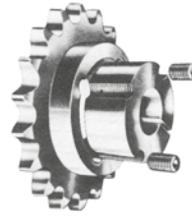

Versione (\*) / Type (\*)  
Typ (\*) / Tipo (\*)

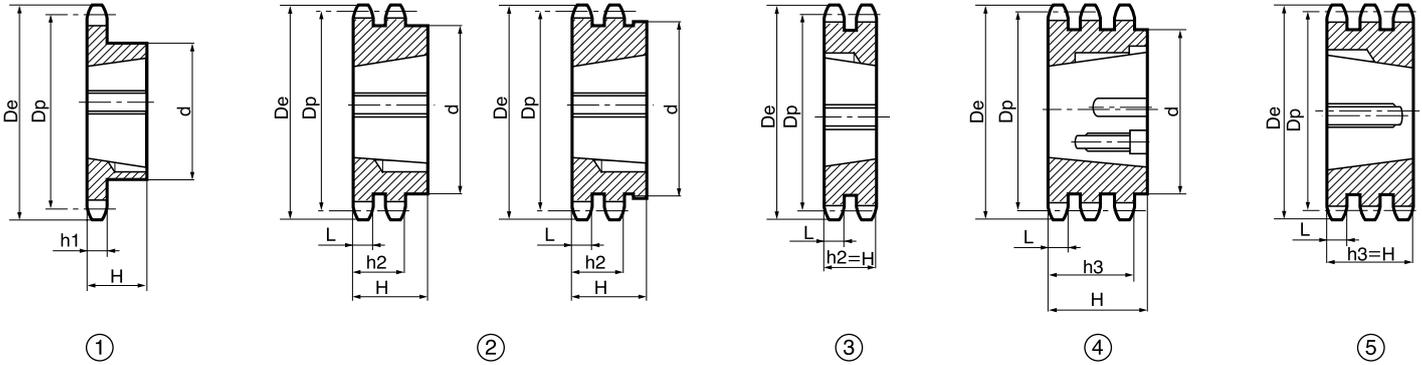

**3/4" x 7/16" - 19,05 x 11,68 mm**

**12B - 1-2-3 - DIN 8187 - ISO/R 606**

CATENA:	CHAIN:	KETTE:	CHAÎNE:	CADENA:	ISO mm
Passo	Pitch	Teilung	Pas	Paso	<b>19,05</b>
Larghezza interna	Internal width	Innere Breite	Largeur interieure	Ancho interno	<b>11,68</b>
Rullo ø	Roller ø	Rollen ø	ø du rouleau	Rodillo ø	<b>12,07</b>

PIGNONE	SPROCKETS	KETTENRÄDER	PIGNONS	PIÑONES	ISO mm
Raggio dente r	Tooth radius r	Radius r	Rayon de denture r	Radio diente r	<b>r 19,0</b>
Larghezza raggio C	Radius width C	Breite C	Largeur de rayon C	Ancho radio C	<b>C 2,0</b>
Largh. dente h <sub>1</sub>	Tooth width h <sub>1</sub>	Zahnbreite h <sub>1</sub>	Larg. de denture h <sub>1</sub>	Ancho diente h <sub>1</sub>	<b>h<sub>1</sub> 11,1</b>
Largh. dente L	Tooth width L	Zahnbreite L	Larg. de denture L	Ancho diente L	<b>L 10,8</b>
Largh. dente h <sub>2</sub>	Tooth width h <sub>2</sub>	Zahnbreite h <sub>2</sub>	Larg. de denture h <sub>2</sub>	Ancho diente h <sub>2</sub>	<b>h<sub>2</sub> 30,3</b>
Largh. dente h <sub>3</sub>	Tooth width h <sub>3</sub>	Zahnbreite h <sub>3</sub>	Larg. de denture h <sub>3</sub>	Ancho diente h <sub>3</sub>	<b>h<sub>3</sub> 49,8</b>

**Acciaio                      Steel                      Stahl                      Acier                      Acero = C 45 E - UNI EN 10083-1**

Z	D <sub>e</sub>	D <sub>p</sub>	TS				TD				TT							
			cod.	d	H	per Bussola for Bush für Buchse pour Moyeux amovibles para Casquillos cónicos	Esecuz. tipo Type Typ Type Tpo	cod.	d	H	per Bussola for Bush für Buchse pour Moyeux amovibles para Casquillos cónicos	Esecuz. tipo Type Typ Type Tpo	cod.	d	H	per Bussola for Bush für Buchse pour Moyeux amovibles para Casquillos cónicos	Esecuz. tipo Type Typ Type Tpo	
13	87,5	79,59	TS 11013	60	25	1210	1											
14	93,6	85,61	TS 11014	70	25	1610	1											
15	99,8	91,63	TS 11015	70	25	1610	1	TD 11015	-	30,3	1610	3	TT 11015	-	49,8	1615	5	
16	105,5	97,65	TS 11016	75	25	1610	1	TD 11016	-	30,3	1610	3						
17	111,5	103,67	TS 11017	76	25	1610	1	TD 11017	-	30,3	1610	3	TT 11017	-	49,8	2012	5	
18	118,0	109,71	TS 11018	90	32	2012	1	TD 11018	90	32,0	2012	2						
19	124,2	115,75	TS 11019	90	32	2012	1	TD 11019	90	32,0	2012	2	TT 11019	-	49,8	2012	5	
20	129,7	121,78	TS 11020	90	32	2012	1	TD 11020	108*	45,0	2517	2						
21	136,0	127,82	TS 11021	102	45	2517	1	TD 11021	108	45,0	2517	2	TT 11021	-	49,8	2517	5	
22	141,8	133,86	TS 11022	102	45	2517	1	TD 11022	108	45,0	2517	2						
23	149,0	139,90	TS 11023	108	45	2517	1	TD 11023	108	45,0	2517	2	TT 11023	-	49,8	2517	5	
24	153,9	145,94	TS 11024	108	45	2517	1	TD 11024	108	45,0	2517	2						
25	160,0	152,00	TS 11025	108	45	2517	1	TD 11025	108	45,0	2517	2	TT 11025	-	49,8	2517	5	
26	165,9	158,04	TS 11026	108	45	2517	1	TD 11026	108	45,0	2517	2						
27	172,3	164,00	TS 11027	108	45	2517	1	TD 11027	108	45,0	2517	2	TT 11027	140	51,0	3020	4	
28	178,0	170,13	TS 11028	108	45	2517	1	TD 11028	108	45,0	2517	2						
30	190,5	182,25	TS 11030	108	45	2517	1	TD 11030	108	45,0	2517	2	TT 11030	140	51,0	3020	4	
38	239,0	230,69	TS 11038	108	45	2517	1	TD 11038	140	51,0	3020	2	TT 11038	140	51,0	3020	4	
45	282,5	273,10	TS 11045	108	45	2517	1	TD 11045	140	51,0	3020	2	TT 11045	140	51,0	3020	4	
57	355,4	345,81	TS 11057	108	45	2517	1	TD 11057	140	51,0	3020	2	TT 11057	140	51,0	3020	4	
76	469,9	460,99	TS 11076	108	45	2517	1	TD 11076	140	51,0	3020	2	TT 11076	140	51,0	3020	4	
95	585,1	576,17	TS 11095	108	45	2517	1	TD 11095	140	51,0	3020	2						
114	700,6	691,36	TS 11114	108	64	2525	1											



**Pignoni per bussole coniche / Taper bored sprockets**  
**Kettenräder für Spannbuchsen / Pignons à moyeu amovible**  
**Piñones para casquillos cónicos**

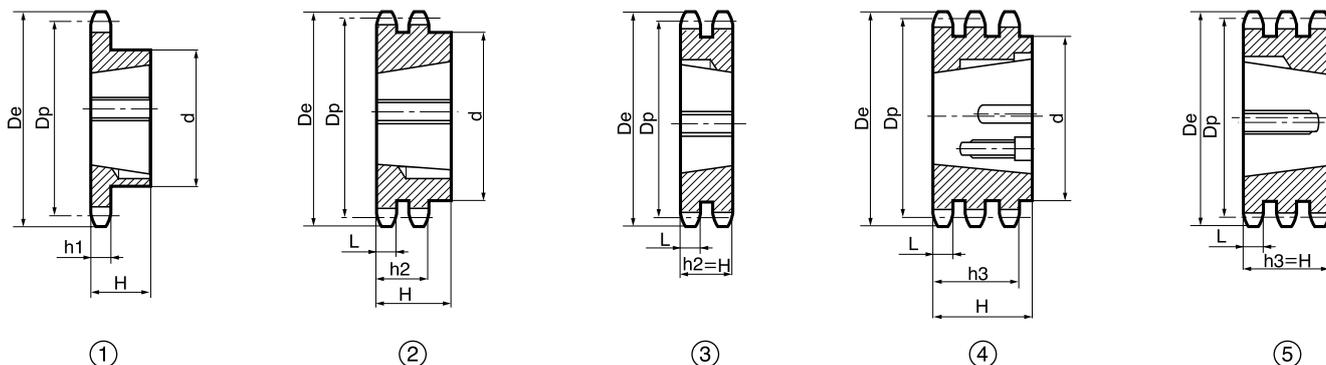

**1" x 17,02 mm - 25,4 x 17,2 mm**

**16B - 1-2-3 - DIN 8187 - ISO/R 606**

CATENA:	CHAIN:	KETTE:	CHAÎNE:	CADENA:	ISO mm
Passo	Pitch	Teilung	Pas	Paso	<b>25,40</b>
Larghezza interna	Internal width	Innere Breite	Largeur interieure	Ancho interno	<b>17,02</b>
Rullo ø	Roller ø	Rollen ø	ø du rouleau	Rodillo ø	<b>15,88</b>

PIGNONE	SPROCKETS	KETTENRÄDER	PIGNONS	PIÑONES	ISO mm
Raggio dente r	Tooth radius r	Radius r	Rayon de denture r	Radio diente r	<b>r 26,0</b>
Larghezza raggio C	Radius width C	Breite C	Largeur de rayon C	Ancho radio C	<b>C 2,5</b>
Largh. dente h <sub>1</sub>	Tooth width h <sub>1</sub>	Zahnbreite h <sub>1</sub>	Larg. de denture h <sub>1</sub>	Ancho diente h <sub>1</sub>	<b>h<sub>1</sub> 16,2</b>
Largh. dente L	Tooth width L	Zahnbreite L	Larg. de denture L	Ancho diente L	<b>L 15,8</b>
Largh. dente h <sub>2</sub>	Tooth width h <sub>2</sub>	Zahnbreite h <sub>2</sub>	Larg. de denture h <sub>2</sub>	Ancho diente h <sub>2</sub>	<b>h<sub>2</sub> 47,7</b>
Largh. dente h <sub>3</sub>	Tooth width h <sub>3</sub>	Zahnbreite h <sub>3</sub>	Larg. de denture h <sub>3</sub>	Ancho diente h <sub>3</sub>	<b>h<sub>3</sub> 79,6</b>

**Acciaio Steel Stahl Acier Acero = C 45 E - UNI EN 10083-1**

Z	D <sub>e</sub>	D <sub>p</sub>	TS				TD				TT						
			cod.	d	H	Esecuz. tipo Type Typ Type Tpo	cod.	d	H	Esecuz. tipo Type Typ Type Tpo	cod.	d	H	Esecuz. tipo Type Typ Type Tpo			
13	117,0	106,12	TS 12013	73	25	1610	1	TD 12013	-	47,7	2012	3					
14	125,0	114,15	TS 12014	76	25	1610	1										
15	133,0	122,17	TS 12015	76	25	1610	1	TD 12015	-	47,7	2012	3					
16	141,0	130,20	TS 12016	90	32	2012	1										
17	149,0	138,22	TS 12017	90	32	2012	1	TD 12017	-	47,7	2517	3	TT 12017	-	79,6	2517	5
18	157,0	146,28	TS 12018	108	45	2517	1										
19	165,2	154,33	TS 12019	108	45	2517	1	TD 12019	-	47,7	2517	3	TT 12019	-	79,6	3020	5
20	173,2	162,38	TS 12020	108	45	2517	1										
21	181,2	170,43	TS 12021	110	45	2517	1	TD 12021	140	51,0	3020	2	TT 12021	-	79,6	3030	5
22	189,3	178,48	TS 12022	110	45	2517	1										
23	197,5	186,53	TS 12023	110	45	2517	1	TD 12023	140	51,0	3020	2	TT 12023	-	79,6	3525	5
24	205,5	194,59	TS 12024	110	45	2517	1										
25	213,5	202,66	TS 12025	110	45	2517	1	TD 12025	140	51,0	3020	2	TT 12025	-	79,6	3525	5
26	221,6	210,72	TS 12026	110	45	2517	1										
27	229,6	218,79	TS 12027	110	45	2517	1	TD 12027	140	51,0	3020	2	TT 12027	-	79,6	3525	5
28	237,7	226,85	TS 12028	110	45	2517	1										
30	254,0	243,00	TS 12030	140	51	3020	1	TD 12030	140	51,0	3020	2	TT 12030	-	79,6	3525	5
38	320,7	307,59	TS 12038	140	51	3020	1	TD 12038	140	51,0	3020	2	TT 12038	-	79,6	3525	5
45	377,1	364,13	TS 12045	140	51	3020	1	TD 12045	140	51,0	3020	2	TT 12045	216	79,6	4030	4
57	474,0	461,07	TS 12057	140	51	3020	1	TD 12057	175	65,0	3525	2	TT 12057	216	79,6	4030	4
76	627,0	614,65	TS 12076	140	51	3020	1	TD 12076	175	65,0	3525	2	TT 12076	216	79,6	4030	4
95	781,1	768,22	TS 12095	140	51	3020	1	TD 12095	215	65,0	3525	2	TT 12095	240	79,6	4030	4
114	934,3	921,81	TS 12114	140	76	3030	1	TD 12114	215	102,0	4040	2					

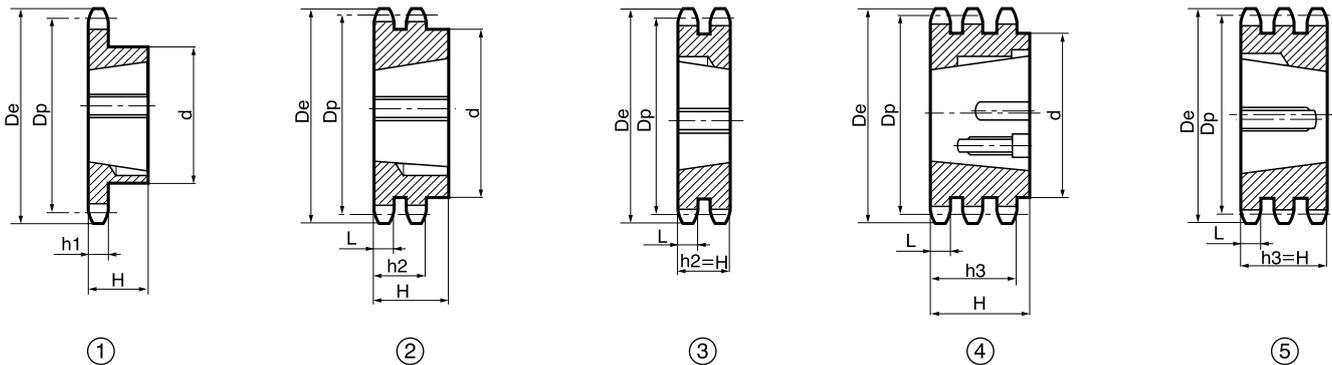
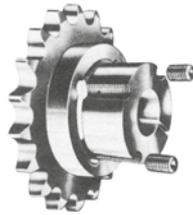

**1" 1/4 x 3/4" - 31,75 x 19,56 mm**

**20B - 1-2-3 - DIN 8187 - ISO/R 606**

CATENA:	CHAIN:	KETTE:	CHAÎNE:	CADENA:	ISO mm
Passo	Pitch	Teilung	Pas	Paso	<b>31,75</b>
Larghezza interna	Internal width	Innere Breite	Largeur interieure	Ancho interno	<b>19,56</b>
Rullo ø	Roller ø	Rollen ø	ø du rouleau	Rodillo ø	<b>19,05</b>

PIGNONE	SPROCKETS	KETTENRÄDER	PIGNONS	PIÑONES	ISO mm
Raggio dente r	Tooth radius r	Radius r	Rayon de denture r	Radio diente r	<b>r 32,0</b>
Larghezza raggio C	Radius width C	Breite C	Largeur de rayon C	Ancho radio C	<b>C 3,5</b>
Largh. dente h <sub>1</sub>	Tooth width h <sub>1</sub>	Zahnbreite h <sub>1</sub>	Larg. de denture h <sub>1</sub>	Ancho diente h <sub>1</sub>	<b>h<sub>1</sub> 18,5</b>
Largh. dente L	Tooth width L	Zahnbreite L	Larg. de denture L	Ancho diente L	<b>L 18,2</b>
Largh. dente h <sub>2</sub>	Tooth width h <sub>2</sub>	Zahnbreite h <sub>2</sub>	Larg. de denture h <sub>2</sub>	Ancho diente h <sub>2</sub>	<b>h<sub>2</sub> 54,6</b>
Largh. dente h <sub>3</sub>	Tooth width h <sub>3</sub>	Zahnbreite h <sub>3</sub>	Larg. de denture h <sub>3</sub>	Ancho diente h <sub>3</sub>	<b>h<sub>3</sub> 91,0</b>

**Acciaio                      Steel                      Stahl                      Acier                      Acero = C45 E - UNI EN 10083-1**

Z	D <sub>e</sub>	D <sub>p</sub>	TS				
			cod.	d	H	per Bussola / for Bush für Buchse / pour Moyeux amovibles para Casquillos cónicos	Esecuz. tipo / Type Typ / Type Tpo
13	147,8	132,65	TS 13013	90	32	2012	1
14	157,8	142,68	TS 13014	90	32	2012	1
15	167,9	152,72	TS 13015	108	45	2517	1
16	177,9	162,75	TS 13016	108	45	2517	1
17	187,9	172,78	TS 13017	108	45	2517	1
18	198,0	182,85	TS 13018	108	45	2517	1
19	208,1	192,91	TS 13019	108	45	2517	1
20	218,1	202,98	TS 13020	108	45	2517	1
21	228,2	213,04	TS 13021	108	45	2517	1
22	238,3	223,11	TS 13022	108	45	2517	1
23	248,3	233,17	TS 13023	108	45	2517	1
24	258,4	243,23	TS 13024	108	45	2517	1
25	268,5	253,33	TS 13025	108	45	2517	1
27	288,6	273,40	TS 13027	150	51	3020	1
30	318,9	303,75	TS 13030	150	51	3020	1
38	399,6	384,49	TS 13038	160	51	3020	1
45	470,3	455,17	TS 13045	160	51	3020	1
57	591,5	576,36	TS 13057	160	51	3020	1
76	783,5	768,32	TS 13076	160	51	3020	1

**Pignoni per bussole coniche temprati ad induzione sui denti (45 ÷ 55 HRC)**  
**Taper bored sprockets with induction hardened teeth (45 ÷ 55 HRC)**  
**Kettenräder für Spannbuchse mit gehärteten zähnen (45 ÷ 55 HRC)**  
**Pignons à moyeu amovible avec denture traitée (45 ÷ 55 HRC)**  
**Piñones para casquillos cónicos con dientes tratados (45 ÷ 55 HRC)**

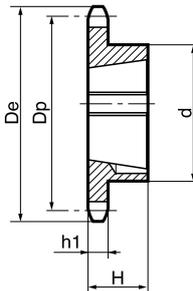

①

**Materiale C 45 E**  
UNI EN 10083-1

**Material C 45 E**  
UNI EN 10083-1

**Werkstoff C 45 E**  
UNI EN 10083-1

**Matière C 45 E**  
UNI EN 10083-1

**Material C 45 E**  
UNI EN 10083-1

**3/8" x 7/32" - 06B R. 6,35**

Z	D <sub>e</sub>	D <sub>p</sub>	TS				Esecuz. tipo Type Typ Type Tpo
			cod.	d	H	per Bussola for Bush für Buchse pour Moyeux amovibles para Casquillos cónicos	
17	55,3	51,83	TS 05T17	45	22	1008	1
18	58,3	54,85	TS 05T18	45	22	1008	1
19	61,3	57,87	TS 05T19	45	22	1008	1
20	64,3	60,89	TS 05T20	46	22	1008	1
21	68,0	63,91	TS 05T21	46	22	1008	1
22	71,0	66,93	TS 05T22	50	22	1008	1
23	73,5	69,95	TS 05T23	63	25	1210	1
24	77,0	72,97	TS 05T24	63	25	1210	1
25	80,0	76,02	TS 05T25	63	25	1210	1
26	83,0	79,02	TS 05T26	63	25	1210	1
27	86,0	82,02	TS 05T27	63	25	1210	1
28	89,0	85,07	TS 05T28	63	25	1210	1
30	94,7	91,12	TS 05T30	63	25	1210	1

**1/2" x 5/16" - 08B R. 8,51**

Z	D <sub>e</sub>	D <sub>p</sub>	TS				Esecuz. tipo Type Typ Type Tpo
			cod.	d	H	per Bussola for Bush für Buchse pour Moyeux amovibles para Casquillos cónicos	
15	65,5	61,90	TS 09T15	45	22	1008	1
16	69,5	65,10	TS 09T16	50	22	1108	1
17	73,6	69,11	TS 09T17	60	25	1210	1
18	77,8	73,14	TS 09T18	60	25	1210	1
19	81,7	77,16	TS 09T19	63	25	1210	1
20	85,8	81,19	TS 09T20	71	25	1610	1
21	89,7	85,22	TS 09T21	71	25	1610	1
22	93,8	89,24	TS 09T22	71	25	1610	1
23	98,2	93,27	TS 09T23	76	25	1610	1
24	101,8	97,29	TS 09T24	76	25	1610	1
25	105,8	101,33	TS 09T25	76	25	1610	1
26	110,0	105,36	TS 09T26	76	25	1610	1
27	114,4	109,40	TS 09T27	76	25	1610	1
28	118,0	113,42	TS 09T28	90	32	2012	1
30	126,1	121,50	TS 09T30	90	32	2012	1

**5/8" x 3/8" - 10B R. 10,16**

Z	D <sub>e</sub>	D <sub>p</sub>	cod.	d	H	per Bussola for Bush für Buchse pour Moyeux amovibles para Casquillos cónicos	Esecuz. tipo Type Typ Type Tpo
13	73,0	66,32	TS 10T13	47	22	1008	1
14	78,0	71,34	TS 10T14	52	22	1108	1
15	83,0	76,36	TS 10T15	60	25	1210	1
16	88,0	81,37	TS 10T16	70	25	1610	1
17	93,0	86,36	TS 10T17	71	25	1610	1
18	98,3	91,42	TS 10T18	75	25	1610	1
19	103,3	96,45	TS 10T19	75	25	1610	1
20	108,4	101,49	TS 10T20	75	25	1610	1
21	113,4	106,52	TS 10T21	76	25	1610	1
22	118,0	111,55	TS 10T22	76	25	1610	1
23	123,4	116,58	TS 10T23	76	25	1610	1
24	128,3	121,62	TS 10T24	90	32	1610	1
25	134,0	126,66	TS 10T25	90	32	2012	1
26	139,0	131,70	TS 10T26	90	32	2012	1
27	144,0	136,75	TS 10T27	90	32	2012	1
28	148,7	141,78	TS 10T28	90	32	2012	1
30	158,8	151,87	TS 10T30	90	32	2012	1

**3/4" x 7/16" - 12B R. 12,07**

Z	D <sub>e</sub>	D <sub>p</sub>	cod.	d	H	per Bussola for Bush für Buchse pour Moyeux amovibles para Casquillos cónicos	Esecuz. tipo Type Typ Type Tpo
13	87,5	79,59	TS 11T13	60	25	1210	1
14	93,6	85,61	TS 11T14	70	25	1610	1
15	99,8	91,63	TS 11T15	70	25	1610	1
16	105,5	97,65	TS 11T16	75	25	1610	1
17	111,5	103,67	TS 11T17	76	25	1610	1
18	118,0	109,71	TS 11T18	90	32	2012	1
19	124,2	115,75	TS 11T19	90	32	2012	1
20	129,7	121,78	TS 11T20	90	32	2012	1
21	136,0	127,82	TS 11T21	102	45	2517	1
22	141,8	133,86	TS 11T22	102	45	2517	1
23	149,0	139,90	TS 11T23	108	45	2517	1
24	153,9	145,94	TS 11T24	108	45	2517	1
25	160,0	152,00	TS 11T25	108	45	2517	1
26	165,9	158,04	TS 11T26	108	45	2517	1
27	172,3	164,00	TS 11T27	108	45	2517	1
28	178,0	170,13	TS 11T28	108	45	2517	1
30	190,5	182,25	TS 11T30	108	45	2517	1

**1" x 17,2 - 16B R. 15,88**

Z	D <sub>e</sub>	D <sub>p</sub>	cod.	d	H	per Bussola for Bush für Buchse pour Moyeux amovibles para Casquillos cónicos	Esecuz. tipo Type Typ Type Tpo
13	117,0	106,12	TS 12T13	73	25	1610	1
14	125,0	114,15	TS 12T14	76	25	1610	1
15	133,0	122,17	TS 12T15	76	25	1610	1
16	141,0	130,20	TS 12T16	90	32	2012	1
17	149,0	138,22	TS 12T17	90	32	2012	1
18	157,0	146,28	TS 12T18	108	45	2517	1
19	165,2	154,33	TS 12T19	108	45	2517	1
20	173,2	162,38	TS 12T20	108	45	2517	1
21	181,2	170,43	TS 12T21	110	45	2517	1
22	189,3	178,48	TS 12T22	110	45	2517	1
23	197,5	186,53	TS 12T23	110	45	2517	1
24	205,5	194,59	TS 12T24	110	45	2517	1
25	213,5	202,66	TS 12T25	110	45	2517	1
26	221,6	210,72	TS 12T26	110	45	2517	1
27	229,6	218,79	TS 12T27	110	45	2517	1
28	237,7	226,85	TS 12T28	110	45	2517	1
30	254,0	243,00	TS 12T30	140	51	3020	1

**1" 1/4 x 3/4" - 20B R. 19,05**

Z	D <sub>e</sub>	D <sub>p</sub>	cod.	d	H	per Bussola for Bush für Buchse pour Moyeux amovibles para Casquillos cónicos	Esecuz. tipo Type Typ Type Tpo
13	147,8	132,65	TS 13T13	90	32	2012	1
15	167,9	152,72	TS 13T15	108	45	2517	1
17	187,9	172,78	TS 13T17	108	45	2517	1
19	208,1	192,91	TS 13T19	108	45	2517	1
21	228,2	213,04	TS 13T21	108	45	2517	1
23	248,3	233,17	TS 13T23	108	45	2517	1
25	268,5	253,33	TS 13T25	108	45	2517	1
27	288,6	273,40	TS 13T27	150	51	3020	1
30	318,9	303,75	TS 13T30	150	51	3020	1

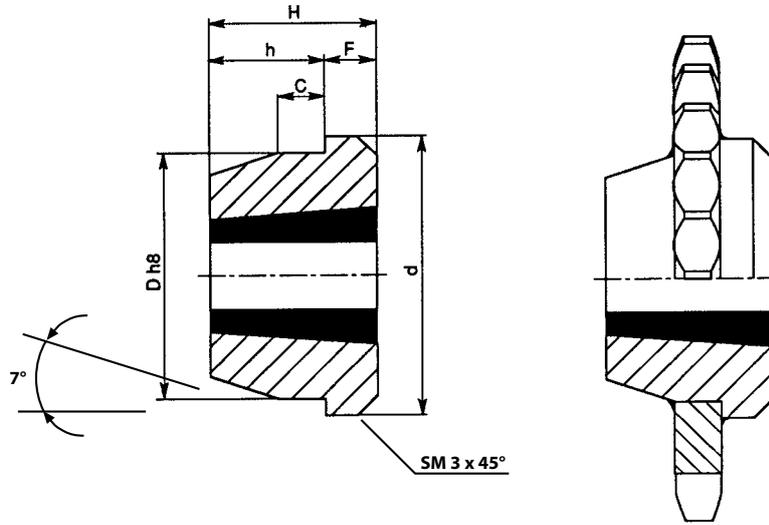

Materiale Fe	Material Fe	Werkstoff Fe	Matière Fe	Material Fe			
Tipo bussola Bush type Buchse typ Moyeux type Casquillos tipo	cod.	d	H	C	F	h	Dh8
1210	MSB1210	73	25	10	9	16	60
1215	MSB1215	76	38	11	16	22	60
1610	MSB1610	83	25	10	9	16	70
1615	MSB1615	83	38	11	16	22	70
2012	MSB2012	96	32	12	10	22	90
2517	MSB2517	127	45	13	19	26	110
3020	MSB3020	152	51	18	24	27	130
3030	MSB3030	152	76	19	25	51	130
3525	MSB3525	184	65	25	25	40	155
3535	MSB3535	184	89	25	32	57	155
4040	MSB4040	225	102	35	32	70	195
4545	MSB4545	254	114	40	38	76	220
5050	MSB5050	276	127	40	38	89	242

Le bussole coniche sono il sistema più pratico e conveniente per fissare dei componenti a un albero di trasmissione senza ricorrere ad attrezzature particolari. Essendo infatti già provviste di foro finito, cava, fori filettati e viti di fissaggio, permettono di risparmiare sui costi e i tempi delle lavorazioni meccaniche speciali. Tutte le bussole coniche della nostra gamma possono essere utilizzate indifferentemente sui seguenti prodotti:

- Pignoni per catena
- Pulegge a gola
- Pulegge dentate
- Giunti flessibili
- Giunti HRC
- Mozzi saldabili

### MONTAGGIO

Assicurarsi che le superfici coniche siano pulite, prive di oli o polveri. Inserire la bussola nella ruota in modo da allineare i fori (1). Posizionare le viti nei fori filettati, senza stringerle. Pulire l'albero e quindi montare ruota e bussola nella posizione desiderata, considerando che la bussola stringe prima l'albero e poi la ruota (2). Stringere le viti prima a mano (3) poi gradualmente e in modo alternato con una chiave esagonale (4). Verificare la chiusura delle viti dopo un breve periodo di funzionamento.

### SMONTAGGIO

Allentare tutte le viti e rimuoverne una o due in base al numero dei fori di smontaggio. Inserire le viti nei fori di smontaggio ed avvitare in modo alternato fino all'allentamento della bussola e fintanto che il gruppo non sia libero sull'albero (5). Rimuovere la bussola e la ruota dall'albero.

Taper bushes are the most convenient and cost effective method of fixing components to a mating shaft without using any special tools. Taper bushes are already provided with the required bore, keyway, threaded holes and setting screws, thus allowing to save time and money on machining processes. All taper bushes in our range are designed for use with all the following products:

- Chain sprockets
- V-belt pulleys
- Timing belt pulleys
- Flexible couplings
- HRC couplings
- Weld-on hubs

### INSTALLATION

After ensuring that the mating surfaces are clean and free from oil and dirt, insert bush in wheel hub so that holes line up (1). Place screws loosely in the threaded holes. Clean shaft and fit assembly to shaft in the position desired, considering that bush will grip the shaft first and then the wheel (2). Tighten screws first by hand (3), then using an Allen wrench, gradually and alternately (4). After short time running of the drive, check tightness of screws.

### REMOVAL

Loosen all screws and remove one or two according to the number of removal holes. Insert screws into removal holes and tighten them alternately until the bush is loosened and the assembly is free on the shaft (5) Remove assembly from the shaft.

Die Spannbüchsen stellen das praktischste und günstigste System zur Befestigung von Bauteilen auf Antriebswellen dar, ohne dass auf spezielle Einrichtungen zurückgegriffen werden muss. Da die Spannbüchsen mit Fertigbohrung, Passfedernut, Gewindebohrungen und Befestigungsschrauben schon versehen sind, ermöglichen sie, an Kosten und Zeitaufwand für spezielle maschinelle Bearbeitungen zu sparen. Alle Spannbüchsen aus unserer Reihe können unterschiedslos auf den folgenden Produkten benutzt werden:

- Kettenräder
- Keilriemenscheiben
- Zahnriemenscheiben
- Drehelastische Kupplungen
- HRC-Kupplungen
- Einschweisnaben

### EINBAU

Sicherstellen dass die Kegelflächen öl- und staubfrei sind, anschließend die Buchse in die Nabe einbauen, und prüfen dass die Bohrungen fluchten (1). Die Befestigungsschrauben in die Gewindebohrungen einsetzen, ohne sie anzuziehen. Die Welle reinigen und die Scheibe zusammen mit der eingesetzten Buchse bis zur gewünschten Lage auf die Welle schieben; dabei beachten, dass die Buchse zuerst an der Welle und dann an der Scheibe spannt (2). Die Befestigungsschrauben zuerst von Hand (3), dann mittels Inbusschlüssel stufenweise und abwechselnd anziehen (4). Nach kurzer Betriebszeit Anzugsmoment der Schrauben überprüfen.

### AUSBAU

Alle Schrauben lösen. Je nach der Anzahl an Abdrückbohrungen ein oder zwei Schrauben ganz heraus-schrauben und in die Abdrückbohrungen einschrauben. Die Schraube oder Schrauben abwechselnd anziehen, bis sich die Buchse aus der Nabe löst und die Scheibe sich frei auf der Welle bewegen lässt (5). Scheibe und Buchse von der Welle abnehmen.

Les moyeux amovibles représentent le système plus pratique et convenable pour fixer des composants sur un arbre de transmission sans avoir recours à aucun outil spécial. Etant déjà pourvus d'alésage, rainure de clavette, trous taraudés et vis de fixation, les moyeux amovibles prêts à monter permettent d'économiser sur les coûts et les temps d'usinage. Tous les moyeux amovibles de notre gamme peuvent être utilisés indifféremment avec les produits suivants:

- Pignons à chaîne
- Poulies trapezoidales
- Poulies dentées
- Accouplements élastiques
- Accouplements HRC
- Moyeux à souder

### MONTAGE

Une fois les surfaces coniques soigneusement nettoyées et dégraissées, introduire le moyeu dans la roue en alignant correctement les taraudages (1). Mettre en place les vis dans les taraudages, sans les serrer. Nettoyer l'arbre, et placer l'ensemble roue et moyeu sur l'arbre à l'endroit désiré, en se rappelant que le moyeu bloque d'abord l'arbre et ensuite la roue (2). Serrer les vis d'abord à la main (3) et ensuite graduellement et alternativement avec une clé à six pans Allen (4). Vérifier le serrage des vis après quelque temps de fonctionnement.

### EXTRACTION

Desserer toutes les vis et en ôter une ou deux selon le nombre des trous d'extraction. Insérer les vis dans les trous d'extraction et les serrer alternativement jusqu'à ce que le moyeu soit débloqué de la roue et que l'ensemble coulisse librement sur l'arbre (5). Oter l'ensemble roue - moyeu de l'arbre.

Los casquillos cónicos son el sistema más práctico y adecuado para fijar unos componentes a un eje de transmisión sin tener que utilizar utilajes particulares. Los caquillos vienen dotados ya de agujero acabado, chavetero, prisioneros y tornillos, permitiendo así de ahorrar tiempo y reducir los gastos de las mecanizaciones especiales. Todos los casquillos cónicos de nuestra gama se pueden utilizar con todos los productos siguientes:

- Piñones por cadena
- Poleas trapezoidales
- Poleas dentadas
- Acoplamiento flexibles
- Acoplamiento HRC
- Cubos soldables

### MONTAJE

Asegurarse que las superficies conicas estén limpias, sin aceites o polvos. Introducir el casquillo en la rueda, de manera que los agujeros resulten alineados (1). Ajustar los tornillos en los prisioneros, sin apretarlos. Limpiar el eje y después montar rueda y casquillo en la posición deseada, teniendo en cuenta que el casquillo antes aprieta el eje y después la rueda (2). Apretar los tornillos manualmente (3), después progresivamente y de manera alternada con una llave hexagonal (4). Averiguar el cierre de los tornillos después de un breve periodo de marcha.

### DESMONTAJE

Soltar todos los tornillos y quitar uno o dos según el número de los agujeros de desmontaje. Introducir los tornillos en los ejes y enroscar de manera alternada hasta la distensión del casquillo, y hasta que el grupo no resulte soldado del eje (5). Quitar el casquillo y la rueda del eje.

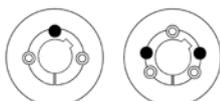

● Fori di smontaggio / Removal holes / Abdrückbohrungen / Trous d'extraction / Agujeros de desmontaje



1



2



3

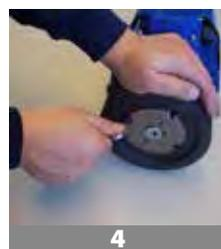

4



5

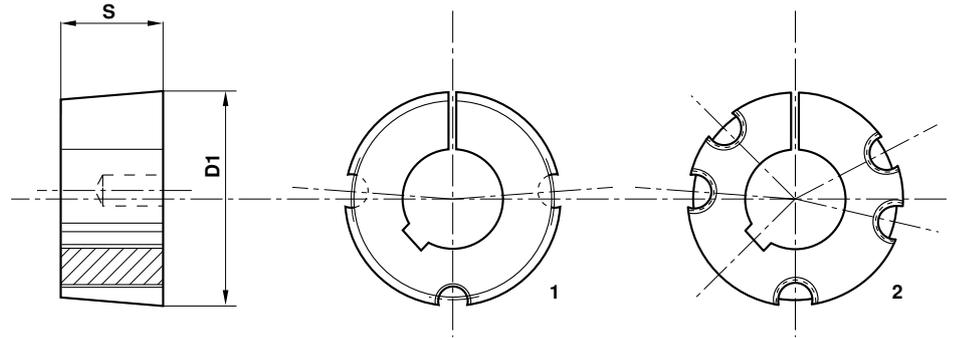
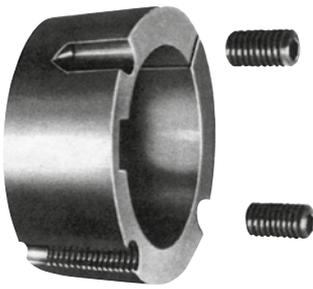

**Ghisa** EN-GJL-250 UNI EN 1561     **Cast iron** EN-GJL-250 UNI EN 1561     **Grauguss** EN-GJL-250 UNI EN 1561     **Fonte** EN-GJL-250 UNI EN 1561     **Hierro fundido** EN-GJL-250 UNI EN 1561

**Fori standard serie metrica**     **Standard stock bores metric series**     **Standard Lagerbohrungen metrische Reihe**     **Alésages standard de stock série métrique**     **Taladros standard de acopio serie métrica**

**Esempio:** Codice Foro in mm Ø 14 = 1615014     **Exemple:** Code symbol Bore in mm Ø 14 = 1615014     **Beispiel:** Fabriknummer Bohrung in mm Ø 14 = 1615014     **Exemple:** Code symbole Alesage en mm Ø 14 = 1615014     **Ejemplo:** Numero de fabrica Taladros en mm Ø 14 = 1615014

Tipo bussola Bush type Buchse typ Moyeux type Casquillos tipo	Cod.	Foro (ISO E 8) Bore (ISO E 8) Bohrung (ISO E 8) Alesage (ISO E 8) Taladro (ISO E 8) mm	Coppia trasmissibile Transmissible torque Haftmoment Couple transmissible Cupla de transmission Nm	Viti Screws Schraube Vis Tornillo B.S.W.	Coppia di serraggio viti Screw tightening torque Anzugsmoment Schrauben Couple de serrage des vis Par de apriete tornillos Nm	D1 mm	Tipo Type Typ Type Tipo	S mm	Peso Weight Gewicht Poids Peso Kg
1008	1008...	9 10 11 12 14 15 16 18 19 20 22 24* 25*	136	1/4" x 1/2"	5,6	35,0	1	22,3	0,16
1108	1108...	9 10 11 12 14 15 16 18 19 20 22 24 25 28*	147	1/4" x 1/2"	5,6	38,0	1	22,3	0,16
1210	1210...	11 12 14 15 16 18 19 20 22 24 25 28 30 32	407	3/8" x 5/8"	19,6	47,5	1	25,4	0,32
1215	1215...	14 19 20 24 25 28	407	3/8" x 5/8"	19,6	47,5	1	38,1	0,50
1610	1610...	14 15 16 18 19 20 22 24 25 28 30 32 35 38 40 42*	486	3/8" x 5/8"	19,6	57,0	1	25,4	0,41
1615	1615...	14 16 18 19 20 22 24 25 28 30 32 35 38 40 42*	486	3/8" x 5/8"	19,6	57,0	1	38,1	0,60
2012	2012...	14 16 18 19 20 22 24 25 28 30 32 35 38 40 42 45 48 50	808	7/16" x 7/8"	30,4	70,0	1	31,8	0,75
2517	2517...	16 18 19 20 22 24 25 28 30 32 35 38 40 42 45 48 50 55 60 65*	1310	1/2" x 1"	48	85,5	1	44,5	1,06
3020	3020...	25 28 30 32 35 38 40 42 45 48 50 55 60 65 70 75	2710	5/8" x 1 1/4	90	108,0	1	50,8	2,50
3030	3030...	35 38 40 42 45 48 50 55 60 65 70 75	2710	5/8" x 1 1/4	90	108,0	1	76,2	3,75
3525	3525...	35 38 40 42 45 48 50 55 60 65 70 75 80 85 90	5060	1/2" x 1 1/2	112	127,0	2	64,9	4,20
3535	3535...	35 38 40 42 45 48 50 55 60 65 70 75 80 85 90	5060	1/2" x 1 1/2	112	127,0	2	88,9	5,13
4030	4030...	40 42 45 48 50 55 60 65 70 75 80 85 90 100	8740	5/8" x 1 1/4	169	146,0	2	76,2	6,75
4040	4040...	40 42 45 48 50 55 60 65 70 75 80 85 90 95 100	8740	5/8" x 1 3/4	169	146,0	2	101,6	7,68
4545	4545...	55 60 65 70 75 80 85 90 95 100	12400	3/4" x 2"	192	162,0	2	115,0	10,56
5040	5040...	70 75 80 85 90 95 100 105 110 115 120 125	14200	7/8" x 2 1/4	271	177,6	2	101,6	14,20
5050	5050...	70 75 80 85 90 95 100 105 110 115 120 125	14200	7/8" x 2 1/4	271	177,6	2	127,0	15,17

**Dimensioni delle cave (UNI 6604 DIN 6885) con foro standard serie metrica**     **Dimensions of keyways (UNI 6604 DIN 6885) with standard bore metric series**     **Abmessungen der Keilnuten (UNI 6604 DIN 6885) mit Standardbohrung metrische Reihe**     **Dimens. des rainures de clavette (UNI 6604 DIN 6885) dans le moyeux avec alésage stand. série métrique**     **Medidas de los chaveteros (UNI 6604 DIN 6885) con agujero standard serie métrica**

D	b	Js9	t	Dimensioni delle cave Dimensions of keyways Abmessungen der Keilnuten Dimensions des rainures de clavette Medidas de los chaveteros		
Over	D*	b	t	D*	b	t
10 to 12	4	± 0,015	D + 1,8	24*	8	D + 1,3
» 12 » 17	5		D + 2,3			
» 17 » 22	6		D + 2,8			
» 22 » 30	8	D + 3,3				
» 30 » 38	10	D + 3,3				
» 38 » 44	12	D + 3,3				
» 44 » 50	14	± 0,021	D + 3,8	25*	8	D + 1,3
» 50 » 58	16		D + 4,3			
» 58 » 65	18		D + 4,4			
» 65 » 75	20	± 0,026	D + 4,9	28*	8	D + 1,3
» 75 » 85	22		D + 5,4			
» 85 » 95	25		D + 5,4			
» 95 » 110	28		D + 6,4			
» 110 » 130	32	± 0,031	D + 7,4	42*	12	D + 1,3
				65*	18	D + 2,8







**Sistemi di bloccaggio**  
**Locking devices**  
**Spannsätze**  
**Moyeux de serrage**  
**Casquillos de fijación**

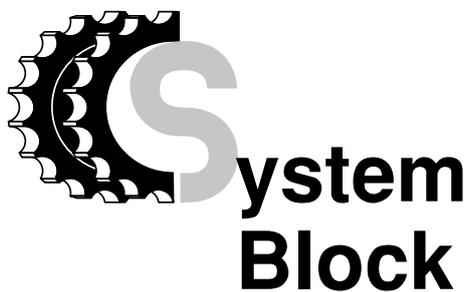

Il principio di funzionamento degli articoli presentati, si basa sulla deformazione radiale dei particolari, a profilo tronco conico, che li compongono: la coppia di serraggio applicata sulle viti di collegamento provoca un movimento assiale dei particolari a contatto tra loro ed, in funzione della conicità inversa e dei tagli longitudinali su di essi praticati, provocano un aumento di diametro (sull'anello esterno) ed una riduzione dello stesso (sull'anello interno). Questa variazione permette (in virtù della pressione specifica tra i corpi a contatto), la trasmissione di una coppia tra albero ed organo ad esso collegato (ingranaggio, puleggia dentata, puleggia trapezoidale od altri organi specifici).

The functioning principle of the articles presented is based on radial deformation of the items, made up of a truncated cone section: the tightening torque applied to the connecting screws causes an axial movement of the parts in contact with each other and, in function of the inverse cone shape and the longitudinal cuts made on them provokes an increase in the diameter (of the external ring) and a reduction of the diameter (of the internal ring). This change allows (by virtue of the specific pressure between the bodies in contact) transmission of the torque between the shaft and the part connected to it (gear, timing belt pulley, V-belt pulley or other specific parts).

Das Funktionsprinzip der vorgestellten Artikel basiert auf der Radialverformung der Teile mit kegelförmigem Profil, aus denen sie bestehen: das auf die Verbindungsschrauben angewandte Anzugsmoment bewirkt eine Axialbewegung der einander berührenden Teile, und in Abhängigkeit von der umgekehrten Kegelförmigkeit und den daran angebrachten Längsschnitten wird einerseits eine Vergrößerung des Durchchnitts (am Außenring), und andererseits eine Verkleinerung des Durchchnitts (am Innenring) bewirkt. Diese Variation gestattet (aufgrund des spezifischen Drucks zwischen den einander berührenden Körpern) die Übertragung eines Moments zwischen der Welle und dem damit verbundenen Organ (Getriebe, Zahnscheibe, Keilriemenscheiben oder sonstige spezifische Organe).

Le principe de fonctionnement des articles présentés se base sur la déformation radiale des pièces, à profil tronqué-conique qui les composent: le couple de serrage appliqué sur les vis de raccordement provoque un mouvement axial des pièces qui sont en contact les unes avec les autres et qui, en fonction de la conicité inverse et des tailles longitudinales qui y sont pratiquées, provoquent une augmentation de diamètre (sur la bague extérieure) et une réduction de ce dernier (sur la bague intérieure). Cette variation assure (en vertu de la pression spécifique qui s'exerce entre les corps en contact) la transmission d'un couple entre l'arbre et l'organe qui lui est raccordé (engrenage, poulie dentée, poulie trapézoïdale ou d'autres organes spécifiques).

El principio de funcionamiento de los artículos presentados se basa en la deformación radial de las piezas, de perfil tronco-cónico, que les componen. El par de apriete aplicado en los tornillos de conexión provoca un movimiento axial de las piezas en contacto entre sí y, en función de la conicidad inversa y de los cortes longitudinales realizados en los mismos, se produce un aumento de diámetro (en el anillo externo) y una reducción del mismo (en el anillo interno). Esta variación (en virtud de la presión específica entre los cuerpos en contacto), permite la transmisión de un par entre el eje y el órgano conectado al mismo (engranaje, polea dentada, polea trapezoidal u otros órganos específicos).

I vantaggi del  system-block sono i seguenti:

- eliminazione del gioco tra albero ed organo condotto
- distribuzione uniforme del carico sull'intero diametro
- facilità di sincronizzazione tra vari, eventuali, organi in batteria tra loro
- riduzione del diametro (di progetto) dell'albero conduttore
- aumento della sezione resistente dell'albero conduttore
- riduzione dei termini di approvvigionamento per assemblaggio macchine
- manutenzione facilitata con annullamento fermo-macchina
- reperibilità ricambi presso i principali sub-fornitori di articoli tecnici.

The advantages of the  system-block are as follows:

- elimination of play between the shaft and the part driven
- uniform distribution of the load over the entire diameter
- facility of synchronisation between the various possible parts connected as a set
- reduction of the diameter (of project) of the drive shaft
- increase of the resistant section of the drive shaft
- reduction of the procurement times for machine assembly
- maintenance facilitated with no need to stop the machine
- availability of spare parts by main sub-suppliers of technical equipment.

Die Vorzüge von  system-block sind:

- Beseitigung des Spiels zwischen Welle und angetriebenem Organ
- gleichmäßige Verteilung der Last auf den gesamten Durchmesser
- einfache Synchronisierung zwischen eventuellen, miteinander zu Sätzen verbundenen Organen
- Reduzierung des (Projekt-) Durchmessers der Antriebswelle
- Erhöhung des Spannungsquerschnitts der Antriebswelle
- Reduzierung des Zeitaufwands beim Zusammenbau der Maschinen
- Vereinfachte Wartung mit Wegfall der Maschinenstillstände
- problemlos bei den wichtigsten Zulieferern von technischen Artikeln zu findende Ersatzteile.

Les avantages du  system-block sont les suivants:

- élimination du jeu entre l'arbre et l'organe conduit
- distribution uniforme de la charge sur tout le diamètre
- facilité de synchronisation entre les différents organes éventuellement montés en batterie
- réduction du diamètre (de projet) de l'arbre conducteur
- augmentation de la section résistante de l'arbre conducteur
- réduction des délais d'approvisionnement pour l'assemblage des machines
- entretien facilité et annulation des arrêts de machine
- pièces de rechange disponibles chez les principaux sous-traitants d'articles techniques.

Las ventajas del  system-block son los siguientes:

- eliminación de la holgura entre eje y órgano conducido
- distribución uniforme de la carga en todo el diámetro
- facilidad de sincronización entre eventuales órganos en batería
- reducción del diámetro (de proyecto) del eje conductor
- aumento de la sección resistente del eje conductor
- reducción de los plazos de aprovisionamiento para ensamblaje de máquinas
- mantenimiento facilitado con anulación de las paradas de la máquina
- recambios en los principales proveedores de artículos técnicos.

**Codice**

**Code**

**Kodex**

**Code**

**Código**

# KL AB 019

calettatore  
locking set  
Spannsatz  
moyeu de serrage  
casquillo de fijación

tipo  
type  
Type  
typ  
tipo

albero  
shaft  
Welle  
arbre  
eje

	AA	AB	BB	CC	DA	DB	EE	FF	GG	HH	MM	NN	PP	FC	RR	SS
Autocentranti Self-centering Selbstzentrierend Autocentreurs Autocentrantes	●	●	●	●	●	●	●	●							●	●
Non autocentranti Not self-centering Nicht selbstzentrierend Non autocentreurs No autocentrantes									●	●	●	●	●	●		
Dim. radiali min. Min. radial dimensions Radialmaße, mindest Dim. radiales, min. Dim. radiales, mín.				●				●				●		●		
Manutenzione assemblaggio rapidi Rapid maintenance and assembly Schnellwartung und -montagesi certo Entretien et assemblage rapides Mantenimiento y ensamblaje rápidos	●	●	●	●	●	●		●	●	●	●	●	●	●	●	●
Coppie medio basse Medium-to-low torque Mittlere-niedrige Drehm. Couples moyens-bas Pares medio-bajos								●		●		●		●		●
Coppie medio alte Medium-to-high torque Mittlere-hohe Drehm. Couples moyens-élevés Pares medio-altos	●	●		●					●		●		●		●	
Coppie elevate High torque Sehr hohe Drehmomente Couples élevés Pares elevados			●		●	●	●									
Autobloccanti Self-locking Selbstsperrend Autobloquants Autobloqueantes	●	●	●	●	●	●	●			●					●	●
Non autobloccanti Non self-locking Nicht Selbstsperrend Non autobloquants No autobloqueantes								●	●		●	●	●	●		

Fattore di servizio (s) Duty factor (s) Betriebsfaktor (s) Facteur de service (s) Factor de servicio (s)	Tipo di carico / Load type / Art der Belastung / Type de charge / Tipo de carga		
	Uniforme / Constant / Einheitlich Uniforme / Uniforme	Intermittente / Intermittent Aussetzend / Intermittente / Intermitente	Alternato / Alternating Abwechselnd / Alternée / Alterna
Motore Elettrico Electric motor Elektromotor Moteur électrique Motor eléctrico	1 - 1,2	1,2 - 1,5	1,5 - 2
Motore a scoppio Combustion engine Explosionsmotor Moteur à explosion Motor de explosion	1,2 - 1,5	1,5 - 2	2 - 3

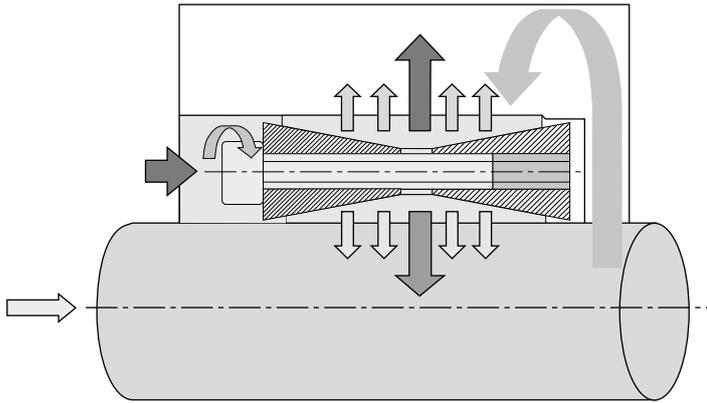

$Pt_{\text{mozzo}} = \pi \cdot D \cdot H_2 \cdot P_m$   
hub / Nabe  
moyeu / cubo

$Pt_{\text{albero}} = \pi \cdot d \cdot H_2 \cdot P_a$   
shaft / Welle  
arbre / eje

$Pt = Pt \cdot \mu \cdot d / 2$

$Ta = 2 \cdot Mt \cdot s$

dove  $Pt_{\text{albero}} = Pt_{\text{mozzo}}$

where:  $Pt_{\text{shaft}} = Pt_{\text{hub}}$

wo:  $Pt_{\text{Welle}} = Pt_{\text{Nabe}}$

où:  $Pt_{\text{arbre}} = Pt_{\text{moyeu}}$

donde:  $Pt_{\text{eje}} = Pt_{\text{cubo}}$

$\mu$  = coefficient d'attrito (0,13) per calettatore lubrificato (a secco 0,15)  
 $s$  = Fattore di servizio

$\mu$  = coefficient of friction (0.13) for lubricated locking set (dry 0.15)  
 $s$  = Duty factor

$\mu$  = Reibungskoeffizient (0,13) für geschmierte Spannsatz (trocken 0,15)  
 $s$  = Betriebsfaktor

$\mu$  = coefficient de frottement (0,13) pour moyeu de serrage lubrifié (à sec 0,15)  
 $s$  = Facteur de service

$\mu$  = coeficiente de fricción (0,13) para casquillo de fijación lubricado (en seco 0,15)  
 $s$  = Factor de servicio

Viti / Screws Schrauben / Vis / Tornillos UNI 5931 DIN 6912-7984	Passo / Pitch Teilung / Pas / Paso (mm)	Coppia serraggio Tv con viti classe 12,9 / Tightening torque Tv with class 12.9 screws Anzugsmoment Tv mit Schrauben Klasse 12,9 / Couple de serrage Tv avec vis classe 12,9 Par de apriete Tv con tornillos clase 12,9 NM (UNI 3740-9)
M6	1,00	17,5
M8	1,25	42,0
M10	1,50	85,0
M12	1,75	145,0
M14	2,00	235,0
M16	2,00	360,0
M18	2,50	485,0
M20	2,50	705,0
M22	2,50	960,0
M24	3,00	1220,0
M30	3,50	2400,0

**Tolleranze e grado rugosità delle superfici**

**Albero:**  
tolleranza h8  
rugosità Rz<=16µm  
**Mozzo:**  
tolleranza H8  
rugosità Rz<=16µm

**Tolerance and degree of roughness of surfaces**

**Shaft:**  
tollerance h8  
roughness Rz<=16µm  
**Hub:**  
tollerance H8  
roughness Rz<=16µm

**Toleranzen und Rauheit der Oberflächen**

**Welle:**  
Toleranz h8  
Rauheit Rz<=16µm  
**Nabe:**  
Toleranz H8  
Rauheit Rz<=16µm

**Tolerances et degré de rugosité des surfaces**

**Arbre:**  
tolérance h8  
rugosité Rz<=16µm  
**Moyeu:**  
tolérance H8  
rugosité Rz<=16µm

**Tolerancias y grado de rugosidad de las superficies**

**Eje:**  
tolerancia h8  
rugosidad Rz<=16µm  
**Cubo:**  
tolerancia H8  
rugosidad Rz<=16µm

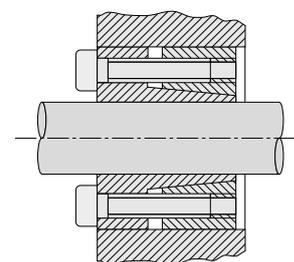
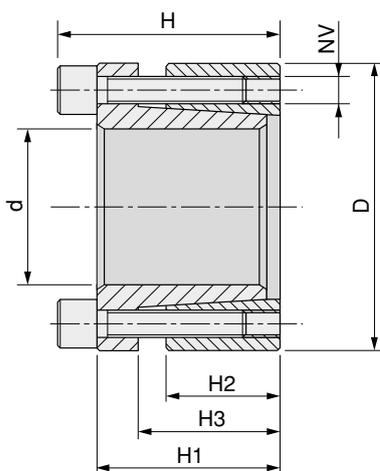

**Materiale C 45 E**  
**UNI EN 10083-1**  
 Dimensioni valide per  
 gruppo non precaricato

**Material C 45 E**  
**UNI EN 10083-1**  
 Dimentionis before  
 mounting

**Werkstoff C 45 E**  
**UNI EN 10083-1**  
 Abmessungen vor Montage

**Matière C 45 E**  
**UNI EN 10083-1**  
 Dimensions avant le  
 montage

**Material C 45 E**  
**UNI EN 10083-1**  
 Dimensiones antes del  
 montaje

Nostro codice Our code Unser Kode Notre code Nuestro código	Dimensioni Dimentions Abmessungen Dimensions Dimensiones						Serraggio Tightening Befestigung Serrage Fijación			Sbloccaggio Loosening Lösen Déblocage Desbloqueo		Prestazioni Performances Leistungen Performances Prestaciones		Pressioni superficiali Surface pressures Oberflächendrucke Pressions de surface Presiones superficiales	
	d	D	H	H1	H2	H3	NV	Tv (Nm)	N° viti / No. of screws Schraubenanzahl Nombre de vis Numero de tornillos	NV	N° viti / No. of screws Schraubenanzahl Nombre de vis Numero de tornillos	Mt (Nm)	Ta (KN)	Pa (N/mm <sup>2</sup> )	Pm (N/mm <sup>2</sup> )
KLAA019	19	47	34	28	17	22	M6x20	13	5	M6x20	3	273	29	262	106
KLAA020	20	47	34	28	17	22	M6x20	13	5	M6x20	3	287	29	249	106
KLAA022	22	47	34	28	17	22	M6x20	13	5	M6x20	3	316	29	227	106
KLAA024	24	50	34	28	17	22	M6x20	13	6	M6x20	3	413	34	249	120
KLAA025	25	50	34	28	17	22	M6x20	13	6	M6x20	3	431	34	239	120
KLAA028	28	55	34	28	17	22	M6x20	13	6	M6x20	3	482	34	213	109
KLAA030	30	55	34	28	17	22	M6x20	13	6	M6x20	3	517	34	199	109
KLAA032	32	60	34	28	17	22	M6x20	13	8	M6x20	4	734	46	249	133
KLAA035	35	60	34	28	17	22	M6x20	13	8	M6x20	4	803	46	227	133
KLAA038	38	65	34	28	17	22	M6x20	13	8	M6x20	4	872	46	210	122
KLAA040	40	65	34	28	17	22	M6x20	13	8	M6x20	4	918	46	199	122
KLAA045	45	75	41	33	20	25	M8x25	32	7	M8x25	3	1674	74	244	146
KLAA050	50	80	41	33	20	25	M8x25	32	7	M8x25	3	1860	74	219	137
KLAA055	55	85	41	33	20	25	M8x25	32	8	M8x25	4	2340	85	228	148
KLAA060	60	90	41	33	20	25	M8x25	32	8	M8x25	4	2553	85	209	139
KLAA065	65	95	41	33	20	25	M8x25	32	9	M8x25	3	3110	96	217	149
KLAA070	70	110	50	40	24	30	M10x30	65	8	M10x30	4	4838	138	243	154
KLAA075	75	115	50	40	24	30	M10x30	65	8	M10x30	4	5184	138	226	148
KLAA080	80	120	50	40	24	30	M10x30	65	8	M10x30	4	5530	138	212	142
KLAA085	85	125	50	40	24	30	M10x30	65	9	M10x30	3	6610	156	225	153
KLAA090	90	130	50	40	24	30	M10x30	65	9	M10x30	3	6998	156	212	147
KLAA095	95	135	50	40	24	30	M10x30	65	10	M10x30	4	8208	173	223	157
KLAA100	100	145	56	44	26	32	M12x35	110	8	M12x35	4	9742	195	221	152
KLAA110	110	155	56	44	26	32	M12x35	110	8	M12x35	4	10716	195	201	143
KLAA120	120	165	56	44	26	32	M12x35	110	9	M12x35	4	13154	219	207	151
KLAA130	130	180	64	52	34	40	M12x35	110	12	M12x35	6	18996	292	195	141
KLAA140	140	190	68	54	34	40	M14x40	170	9	M14x40	4	20336	291	180	133
KLAA150	150	200	68	54	34	40	M14x40	170	10	M14x40	5	24211	323	187	140

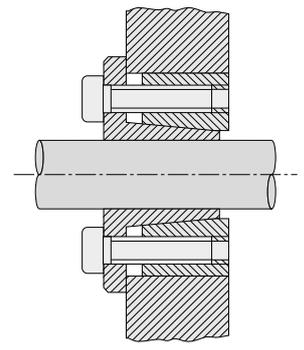
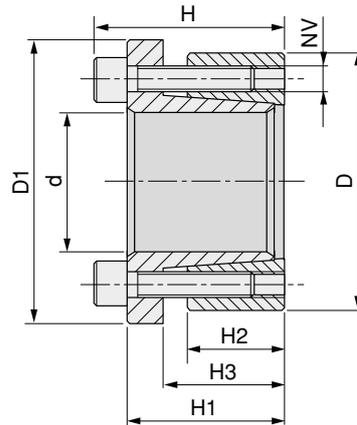

**Materiale C 45 E**  
**UNI EN 10083-1**  
Dimensioni valide per  
gruppo non precaricato

**Material C 45 E**  
**UNI EN 10083-1**  
Dimentions before  
mounting

**Werkstoff C 45 E**  
**UNI EN 10083-1**  
Abmessungen vor Montage

**Matière C 45 E**  
**UNI EN 10083-1**  
Dimensions avant le  
montage

**Material C 45 E**  
**UNI EN 10083-1**  
Dimensiones antes del  
montaje

Nostro codice Our code Unser Kode Notre code Nuestro código	Dimensioni Dimensions Abmessungen Dimensions Dimensiones							Serraggio Tightening Befestigung Serrage Fijación			Sbloccaggio Loosening Lösen Déblocage Desbloqueo		Prestazioni Performances Leistungen Performances Prestaciones		Pressioni superficiali Surface pressures Oberflächendrücke Pressions de surface Presiones superficiales	
	d	D	D1	H	H1	H2	H3	NV	Tv (Nm)	N° viti / No. of screws Schraubenanzahl Nombre de vis Numero de tornillos	NV	N° viti / No. of screws Schraubenanzahl Nombre de vis Numero de tornillos	Mt (Nm)	Ta (KN)	Pa (N/mm <sup>2</sup> )	Pm (N/mm <sup>2</sup> )
KLAB019	19	47	56	34	28	17	22	M6x20	17	5	M6x20	3	243	26	234	94
KLAB020	20	47	56	34	28	17	22	M6x20	17	5	M6x20	3	256	26	222	94
KLAB022	22	47	56	34	28	17	22	M6x20	17	5	M6x20	3	282	26	202	94
KLAB024	24	50	59	34	28	17	22	M6x20	17	6	M6x20	3	368	31	222	106
KLAB025	25	50	59	34	28	17	22	M6x20	17	6	M6x20	3	383	31	213	106
KLAB028	28	55	64	34	28	17	22	M6x20	17	6	M6x20	3	429	31	190	97
KLAB030	30	55	64	34	28	17	22	M6x20	17	6	M6x20	3	460	31	177	97
KLAB032	32	60	69	34	28	17	22	M6x20	17	8	M6x20	4	655	41	222	118
KLAB035	35	60	69	34	28	17	22	M6x20	17	8	M6x20	4	716	41	203	118
KLAB038	38	65	74	34	28	17	22	M6x20	17	8	M6x20	4	778	41	187	109
KLAB040	40	65	74	34	28	17	22	M6x20	17	8	M6x20	4	819	41	178	109
KLAB045	45	75	84	41	33	20	25	M8x25	41	7	M8x25	3	1458	65	212	127
KLAB050	50	80	89	41	33	20	25	M8x25	41	7	M8x25	3	1620	65	191	119
KLAB055	55	85	94	41	33	20	25	M8x25	41	8	M8x25	4	2037	74	199	129
KLAB060	60	90	99	41	33	20	25	M8x25	41	8	M8x25	4	2223	74	182	121
KLAB065	65	95	104	41	33	20	25	M8x25	41	9	M8x25	3	2710	83	189	129
KLAB070	70	110	119	50	40	24	30	M10x30	83	8	M10x30	4	4203	120	211	134
KLAB075	75	115	124	50	40	24	30	M10x30	83	8	M10x30	4	4754	120	197	128
KLAB080	80	120	129	50	40	24	30	M10x30	83	8	M10x30	4	4804	120	184	123
KLAB085	85	125	134	50	40	24	30	M10x30	83	9	M10x30	3	5742	135	195	133
KLAB090	90	130	139	50	40	24	30	M10x30	83	9	M10x30	3	6080	135	184	128
KLAB095	95	135	144	50	40	24	30	M10x30	83	10	M10x30	4	7131	150	194	137
KLAB100	100	145	154	56	44	26	32	M12x35	145	8	M12x35	4	8732	175	198	137
KLAB110	110	155	164	56	44	26	32	M12x35	145	8	M12x35	4	9605	175	180	128
KLAB120	120	165	174	56	44	26	32	M12x35	145	9	M12x35	4	11787	196	186	135
KLAB130	130	180	189	64	52	34	40	M12x35	145	12	M12x35	6	17024	262	175	126
KLAB140	140	190	199	68	54	34	40	M14x40	230	9	M14x40	4	18703	267	166	122
KLAB150	150	200	209	68	54	34	40	M14x40	230	10	M14x40	5	22259	297	172	129

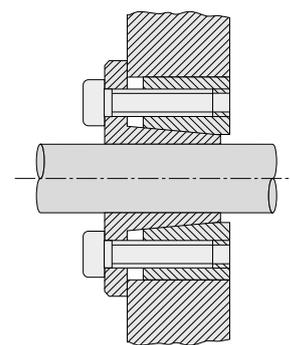
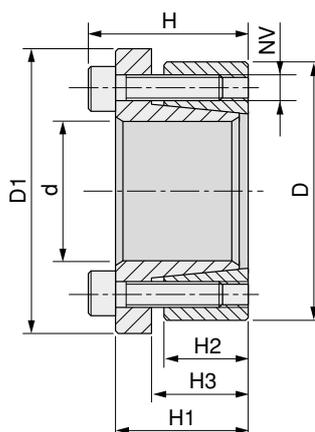

**Materiale C 45 E**  
**UNI EN 10083-1**  
 Dimensioni valide per  
 gruppo non precaricato

**Material C 45 E**  
**UNI EN 10083-1**  
 Dimentions before  
 mounting

**Werkstoff C 45 E**  
**UNI EN 10083-1**  
 Abmessungen vor Montage

**Matière C 45 E**  
**UNI EN 10083-1**  
 Dimensions avant le  
 montage

**Material C 45 E**  
**UNI EN 10083-1**  
 Dimensiones antes del  
 montaje

Nostro codice Our code Unser Kode Notre code Nuestro código	Dimensioni Dimensions Abmessungen Dimensions Dimensiones							Serraggio Tightening Befestigung Serrage Fijación			Sbloccaggio Loosening Lösen Débloccage Desbloqueo		Prestazioni Performances Leistungen Performances Prestaciones		Pressioni superficiali Surface pressures Oberflächendrücke Pressions de surface Presiones superficiales	
	d	D	D1	H	H1	H2	H3	NV	Tv (Nm)	N° viti / No. of screws Schraubenanzahl Nombre de vis Numero de tornillos	NV	N° viti / No. of screws Schraubenanzahl Nombre de vis Numero de tornillos	Mt (Nm)	Ta (KN)	Pa (N/mm <sup>2</sup> )	Pm (N/mm <sup>2</sup> )
KLBB114	14	55	62	39	31	17	22	M8x25	37	4	M8x25	2	234	33	415	106
KLBB116	16	55	62	39	31	17	22	M8x25	37	4	M8x25	2	268	33	363	106
KLBB118	18	55	62	39	31	17	22	M8x25	41	4	M8x25	2	333	37	357	117
KLBB119	19	55	62	39	31	17	22	M8x25	41	4	M8x25	2	352	37	338	117
KLBB120	20	55	62	39	31	17	22	M8x25	41	4	M8x25	2	370	37	321	117
KLBB122	22	55	62	39	31	17	22	M8x25	41	4	M8x25	2	407	37	292	117
KLBB124	24	55	62	39	31	17	22	M8x25	41	4	M8x25	2	445	37	268	117
KLBB125	25	55	62	39	31	17	22	M8x25	41	4	M8x25	2	463	37	257	117
KLBB128	28	55	62	39	31	17	22	M8x25	41	4	M8x25	2	519	37	229	117
KLBB130	30	55	62	39	31	17	22	M8x25	41	4	M8x25	2	556	37	214	117
KLBB224	24	65	72	39	31	17	22	M8x25	41	5	M8x25	3	556	46	335	124
KLBB225	25	65	72	39	31	17	22	M8x25	41	5	M8x25	3	579	46	321	124
KLBB228	28	65	72	39	31	17	22	M8x25	41	5	M8x25	3	649	46	287	124
KLBB230	30	65	72	39	31	17	22	M8x25	41	5	M8x25	3	695	46	268	124
KLBB232	32	65	72	39	31	17	22	M8x25	41	5	M8x25	3	741	46	251	124
KLBB233	33	65	72	39	31	17	22	M8x25	41	5	M8x25	3	764	46	242	124
KLBB235	35	65	72	39	31	17	22	M8x25	41	5	M8x25	3	811	46	230	124
KLBB238	38	65	72	39	31	17	22	M8x25	41	5	M8x25	3	917	46	211	124
KLBB240	40	65	72	39	31	17	22	M8x25	41	5	M8x25	3	966	46	201	124
KLBB330	30	80	87	41	33	20	25	M8x25	41	7	M8x25	3	972	65	318	119
KLBB332	32	80	87	41	33	20	25	M8x25	41	7	M8x25	3	1037	65	299	119
KLBB333	33	80	87	41	33	20	25	M8x25	41	7	M8x25	3	1069	65	289	119
KLBB335	35	80	87	41	33	20	25	M8x25	41	7	M8x25	3	1134	65	273	119
KLBB338	38	80	87	41	33	20	25	M8x25	41	7	M8x25	3	1231	65	251	119
KLBB340	40	80	87	41	33	20	25	M8x25	41	7	M8x25	3	1296	65	239	119
KLBB342	42	80	87	41	33	20	25	M8x25	41	7	M8x25	3	1361	65	227	119
KLBB345	45	80	87	41	33	20	25	M8x25	41	7	M8x25	3	1458	65	212	119
KLBB348	48	80	87	41	33	20	25	M8x25	41	7	M8x25	3	1555	65	199	119
KLBB350	50	80	87	41	33	20	25	M8x25	41	7	M8x25	3	1620	65	191	119

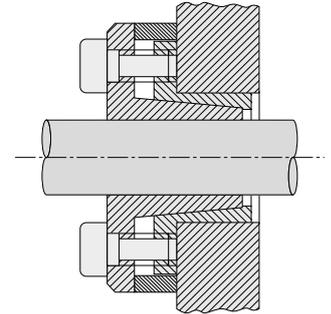
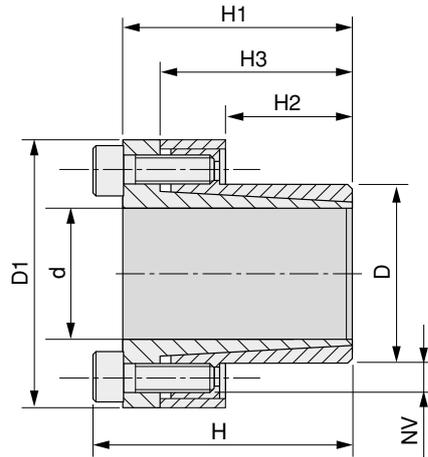
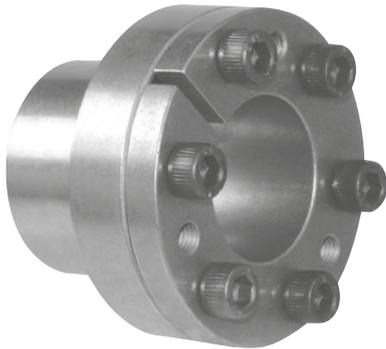

**Materiale C 45 E**  
**UNI EN 10083-1**  
Dimensioni valide per  
gruppo non precaricato

**Material C 45 E**  
**UNI EN 10083-1**  
Dimentions before  
mounting

**Werkstoff C 45 E**  
**UNI EN 10083-1**  
Abmessungen vor Montage

**Matière C 45 E**  
**UNI EN 10083-1**  
Dimensions avant le  
montage

**Material C 45 E**  
**UNI EN 10083-1**  
Dimensiones antes del  
montaje

Nostro codice Our code Unser Kode Notre code Nuestro codigo	Dimensioni Dimensions Abmessungen Dimensions Dimensiones							Serraggio Tightening Befestigung Serrage Fijación			Sbloccaggio Loosening Lösen Débloccage Desbloqueo		Prestazioni Performances Leistungen Performances Prestaciones		Pressioni superficiali Surface pressures Oberflächendrücke Pressions de surface Presiones superficiales	
	d	D	D1	H	H1	H2	H3	NV	Tv (Nm)	N° viti / No. of screws Schraubenanzahl Nombre de vis Numero de tornillos	NV	N° viti / No. of screws Schraubenanzahl Nombre de vis Numero de tornillos	Mt (Nm)	Ta (KN)	Pa (N/mm <sup>2</sup> )	Pm (N/mm <sup>2</sup> )
KLCC008	8	15	28	28	24	12	21	M4x10	4,81	4	M4x10	3	39	10	299	159
KLCC009	9	16	32	31	27	14	23	M4x12	5,2	4	M4x12	3	44	10	227	128
KLCC010	10	16	32	31	27	14	23	M4x12	5,2	4	M4x12	3	49	10	205	128
KLCC011	11	18	34	31	27	14	23	M4x12	5,2	4	M4x12	3	53	10	186	114
KLCC012	12	18	34	31	27	14	23	M4x12	5,2	4	M4x12	3	58	10	171	114
KLCC014	14	23	39	31	27	14	23	M4x12	5,2	4	M4x12	3	68	10	146	89
KLCC015	15	24	45	42	36	16	29	M6x18	17	3	M6x18	2	120	16	196	123
KLCC016	16	24	45	42	36	16	29	M6x18	17	3	M6x18	2	128	16	184	123
KLCC018	18	26	47	44	38	18	31	M6x18	17	4	M6x18	3	191	21	194	134
KLCC019	19	27	48	44	38	18	31	M6x18	17	4	M6x18	3	202	21	183	129
KLCC020	20	28	49	44	38	18	31	M6x18	17	4	M6x18	3	213	21	174	124
KLCC022	22	32	54	51	45	25	38	M6x18	17	4	M6x18	3	234	21	114	78
KLCC024	24	34	56	51	45	25	38	M6x18	17	4	M6x18	3	255	21	105	74
KLCC025	25	34	56	51	45	25	38	M6x18	17	4	M6x18	3	266	21	100	74
KLCC028	28	39	61	51	45	25	38	M6x18	17	5	M6x18	3	373	27	112	81
KLCC030	30	41	63	51	45	25	38	M6x18	17	6	M6x18	3	480	32	126	92
KLCC032	32	43	65	56	50	30	43	M6x18	17	6	M6x18	3	511	32	98	73
KLCC035	35	47	69	56	50	30	43	M6x18	17	8	M6x18	4	747	43	120	89
KLCC038	38	50	72	56	50	30	43	M6x18	17	8	M6x18	4	811	43	110	84
KLCC040	40	53	75	58	52	32	45	M6x18	17	9	M6x18	4	959	48	110	83
KLCC042	42	55	77	58	52	32	45	M6x18	17	9	M6x18	4	1007	48	105	80
KLCC045	45	59	85	72	64	40	56	M8x22	42	8	M8x22	4	1781	79	130	99
KLCC048	48	62	88	72	64	40	56	M8x22	42	8	M8x22	4	1900	79	122	94
KLCC050	50	65	92	82	74	50	66	M8x22	42	10	M8x22	5	2473	99	117	90
KLCC055	55	71	98	82	74	50	66	M8x22	42	10	M8x22	5	2721	99	106	82
KLCC060	60	77	104	82	74	50	66	M8x22	42	10	M8x22	5	2968	99	97	76
KLCC065	65	84	111	82	74	50	66	M8x22	42	10	M8x22	5	3215	99	90	69
KLCC070	70	90	122	101	91	60	80	M10x25	84	8	M10x25	4	4430	127	89	69
KLCC075	75	95	126	101	91	60	80	M10x25	84	9	M10x25	4	5338	142	93	74
KLCC080	80	100	131	106	96	65	85	M10x25	84	12	M10x25	5	7595	190	108	86
KLCC085	85	106	137	106	96	65	85	M10x25	84	12	M10x25	5	8069	190	101	81
KLCC090	90	112	143	106	96	65	85	M10x25	84	14	M10x25	6	9968	222	112	90
KLCC095	95	120	153	106	96	65	85	M10x25	84	14	M10x25	6	10522	222	106	84
KLCC100	100	125	162	114	102	65	89	M12x30	145	12	M12x30	5	13651	273	124	99
KLCC110	110	140	177	119	107	70	94	M12x30	145	12	M12x30	5	15016	273	105	82
KLCC120	120	155	195	139	127	90	114	M12x30	145	16	M12x30	7	21844	364	99	77
KLCC130	130	165	205	139	127	90	114	M12x30	145	16	M12x30	7	23664	364	92	72
KLCC140	140	175	215	139	127	90	114	M12x30	145	16	M12x30	7	25485	364	85	68
KLCC150	150	185	225	139	127	90	114	M12x30	145	16	M12x30	7	27305	364	80	64



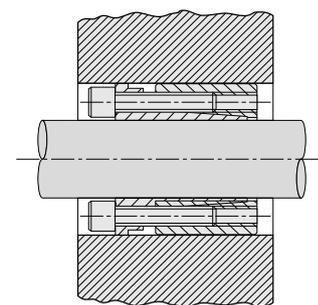
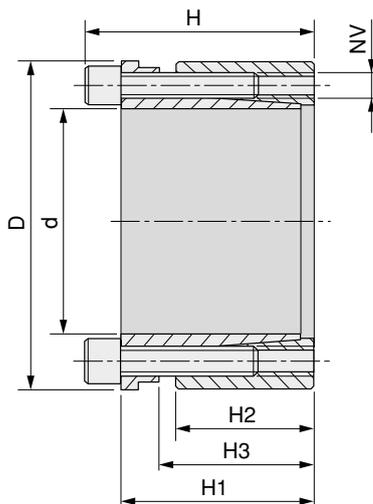

**Materiale C 45 E**  
**UNI EN 10083-1**  
 Dimensioni valide per  
 gruppo non precaricato

**Material C 45 E**  
**UNI EN 10083-1**  
 Dimentions before  
 mounting

**Werkstoff C 45 E**  
**UNI EN 10083-1**  
 Abmessungen vor Montage

**Matière C 45 E**  
**UNI EN 10083-1**  
 Dimensions avant le  
 montage

**Material C 45 E**  
**UNI EN 10083-1**  
 Dimensiones antes del  
 montaje

Nostro codice Our code Unser Kode Notre code Nuestro código	Dimensioni Dimentions Abmessungen Dimensions Dimensiones						Serraggio Tightening Befestigung Serrage Fijación			Sbloccaggio Loosening Lösen Déblocage Desbloqueo		Prestazioni Performances Leistungen Performances Prestaciones		Pressioni superficiali Surface pressures Oberflächendrucke Pressions de surface Presiones superficiales	
	d	D	H	H1	H2	H3	NV	Tv (Nm)	N° viti / No. of screws Schraubenanzahl Nombre de vis Numero de tornillos	NV	N° viti / No. of screws Schraubenanzahl Nombre de vis Numero de tornillos	Mt (Nm)	Ta (KN)	Pa (N/mm <sup>2</sup> )	Pm (N/mm <sup>2</sup> )
KLDA019	19	47	45	39	26	31	M6x25	17	4	M6x25	2	307	32	193	78
KLDA020	20	47	45	39	26	31	M6x25	17	4	M6x25	2	323	32	183	78
KLDA022	22	47	45	39	26	31	M6x25	17	4	M6x25	2	355	32	166	78
KLDA024	24	50	45	39	26	31	M6x25	17	6	M6x25	3	382	48	229	110
KLDA025	25	50	45	39	26	31	M6x25	17	6	M6x25	3	606	48	220	110
KLDA028	28	55	45	39	26	31	M6x25	17	6	M6x25	3	679	48	196	100
KLDA030	30	55	45	39	26	31	M6x25	17	6	M6x25	3	727	48	183	100
KLDA032	32	60	45	39	26	31	M6x25	17	8	M6x25	4	1033	65	229	122
KLDA035	35	60	45	39	26	31	M6x25	17	8	M6x25	4	1130	65	209	122
KLDA038	38	65	45	39	26	31	M6x25	17	8	M6x25	4	1227	65	193	113
KLDA040	40	65	45	39	26	31	M6x25	17	8	M6x25	4	1292	65	183	113
KLDA042	42	75	55	47	30	36	M8x30	41	6	M8x30	3	1835	87	204	115
KLDA045	45	75	55	47	30	36	M8x30	41	6	M8x30	3	1966	87	191	115
KLDA048	48	80	55	47	30	36	M8x30	41	6	M8x30	3	2097	87	179	107
KLDA050	50	80	55	47	30	36	M8x30	41	6	M8x30	3	2184	87	172	107
KLDA055	55	85	55	47	30	36	M8x30	41	8	M8x30	4	3202	116	208	135
KLDA060	60	90	55	47	30	36	M8x30	41	8	M8x30	4	3493	116	191	127
KLDA065	65	95	55	47	30	36	M8x30	41	8	M8x30	4	3784	116	176	120
KLDA070	70	110	67	57	40	46	M10x35	83	8	M10x35	4	6607	189	199	127
KLDA075	75	115	72	62	40	46	M10x35	83	8	M10x35	4	7079	189	186	121
KLDA080	80	120	72	62	40	46	M10x35	83	8	M10x35	4	7551	189	174	116
KLDA085	85	125	72	62	40	46	M10x35	83	10	M10x35	4	10029	236	205	139
KLDA090	90	130	72	62	40	46	M10x35	83	10	M10x35	4	10619	236	193	134
KLDA095	95	135	72	62	40	46	M10x35	83	10	M10x35	4	11209	236	183	129
KLDA100	100	145	89	77	46	52	M12x45	145	8	M12x45	4	13738	275	176	121
KLDA110	110	155	89	77	46	52	M12x45	145	8	M12x45	4	15111	278	160	114
KLDA120	120	165	89	77	46	52	M12x45	145	10	M12x45	4	20606	343	183	133
KLDA130	130	180	89	77	46	52	M12x45	145	12	M12x45	4	26788	412	203	147
KLDA140	140	190	98	84	51	59	M14x45	230	8	M14x45	4	26142	373	154	114
KLDA150	150	200	98	84	51	59	M14x45	230	10	M14x45	5	35016	467	180	135

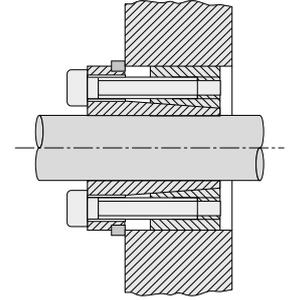
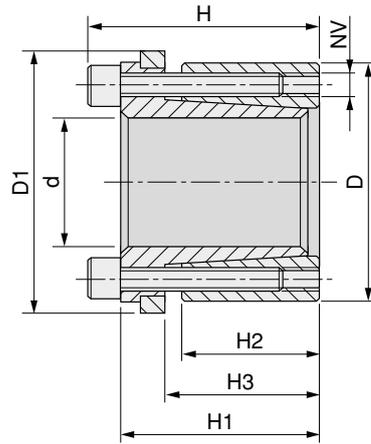

**Materiale C 45 E**  
**UNI EN 10083-1**  
 Dimensioni valide per  
 gruppo non precaricato

**Material C 45 E**  
**UNI EN 10083-1**  
 Dimentions before  
 mounting

**Werkstoff C 45 E**  
**UNI EN 10083-1**  
 Abmessungen vor Montage

**Matière C 45 E**  
**UNI EN 10083-1**  
 Dimensions avant le  
 montage

**Material C 45 E**  
**UNI EN 10083-1**  
 Dimensiones antes del  
 montaje

Nostro codice Our code Unser Kode Notre code Nuestro codigo	Dimensioni Dimentions Abmessungen Dimensions Dimensiones							Serraggio Tightening Befestigung Serrage Fijación			Sbloccaggio Loosening Lösen Déblocage Desbloqueo		Prestazioni Performances Leistungen Performances Prestaciones		Pressioni superficiali Surface pressures Oberflächendrücke Pressions de surface Presiones superficiales	
	d	D	D1	H	H1	H2	H3	NV	Tv (Nm)	N° viti / No. of screws Schraubenanzahl Nombre de vis Numero de tornillos	NV	N° viti / No. of screws Schraubenanzahl Nombre de vis Numero de tornillos	Mt (Nm)	Ta (KN)	Pa (N/mm <sup>2</sup> )	Pm (N/mm <sup>2</sup> )
KLDB019	19	47	53	45	39	26	31	M6x20	17	4	M6x20	2	202	21	127	51
KLDB020	20	47	53	45	39	26	31	M6x20	17	4	M6x20	2	213	21	121	51
KLDB022	22	47	53	45	39	26	31	M6x20	17	4	M6x20	2	234	21	110	51
KLDB024	24	50	56	45	39	26	31	M6x20	17	6	M6x20	3	384	32	151	73
KLDB025	25	50	56	45	39	26	31	M6x20	17	6	M6x20	3	400	32	145	73
KLDB028	28	55	61	45	39	26	31	M6x20	17	6	M6x20	3	448	32	129	66
KLDB030	30	55	61	45	39	26	31	M6x20	17	6	M6x20	3	480	32	121	66
KLDB032	32	60	66	45	39	26	31	M6x20	17	8	M6x20	4	683	43	151	81
KLDB035	35	60	66	45	39	26	31	M6x20	17	8	M6x20	4	747	43	138	81
KLDB038	38	65	71	45	39	26	31	M6x20	17	8	M6x20	4	811	43	127	74
KLDB040	40	65	71	45	39	26	31	M6x20	17	8	M6x20	4	853	43	121	74
KLDB042	42	75	81	55	47	30	36	M8x30	41	6	M8x30	3	1216	58	135	76
KLDB045	45	75	81	55	47	30	36	M8x30	41	6	M8x30	3	1302	58	126	76
KLDB048	48	80	86	55	47	30	36	M8x30	41	6	M8x30	3	1389	58	119	71
KLDB050	50	80	86	55	47	30	36	M8x30	41	6	M8x30	3	1447	58	114	71
KLDB055	55	85	91	55	47	30	36	M8x30	41	8	M8x30	4	2124	77	138	89
KLDB060	60	90	96	55	47	30	36	M8x30	41	8	M8x30	4	2317	77	127	84
KLDB065	65	95	101	55	47	30	36	M8x30	41	8	M8x30	4	2510	77	117	80
KLDB070	70	110	116	67	57	40	46	M10x35	83	8	M10x35	4	4381	125	132	84
KLDB075	75	115	121	72	62	40	46	M10x35	83	8	M10x35	4	4694	125	123	80
KLDB080	80	120	126	72	62	40	46	M10x35	83	8	M10x35	4	5007	125	115	77
KLDB085	85	125	131	72	62	40	46	M10x35	83	10	M10x35	4	6651	156	136	92
KLDB090	90	130	136	72	62	40	46	M10x35	83	10	M10x35	4	7042	156	128	89
KLDB095	95	135	141	72	62	40	46	M10x35	83	10	M10x35	4	7433	156	121	85
KLDB100	100	145	151	89	77	46	52	M12x45	145	8	M12x45	4	9104	182	117	81
KLDB110	110	155	161	89	77	46	52	M12x45	145	8	M12x45	4	10015	182	106	75
KLDB120	120	165	171	89	77	46	52	M12x45	145	10	M12x45	4	13653	228	122	88
KLDB130	130	180	186	89	77	46	52	M12x45	145	12	M12x45	4	17747	273	135	97
KLDB140	140	190	196	98	84	51	59	M14x45	230	8	M14x45	4	17328	248	102	75
KLDB150	150	200	206	98	84	51	59	M14x45	230	10	M14x45	5	23207	309	119	89

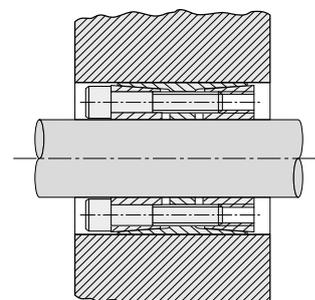
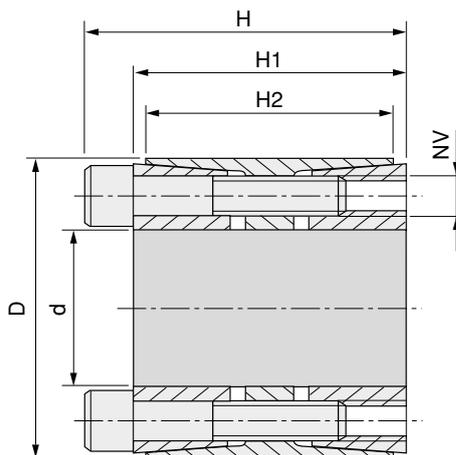
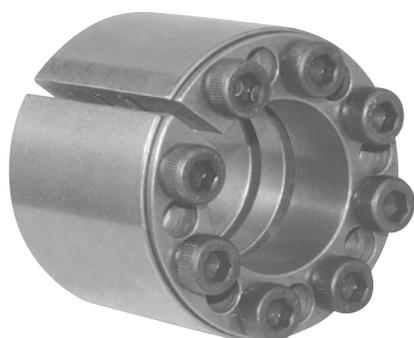

**Materiale C 45 E**  
**UNI EN 10083-1**  
Dimensioni valide per  
gruppo non precaricato

**Material C 45 E**  
**UNI EN 10083-1**  
Dimentions before  
mounting

**Werkstoff C 45 E**  
**UNI EN 10083-1**  
Abmessungen vor Montage

**Matière C 45 E**  
**UNI EN 10083-1**  
Dimensions avant le  
montage

**Material C 45 E**  
**UNI EN 10083-1**  
Dimensiones antes del  
montaje

Nostro codice Our code Unser Kode Notre code Nuestro codigo	Dimensioni Dimensions Abmessungen Dimensions Dimensiones					Serraggio Tightening Befestigung Serrage Fijación			Sbloccaggio Loosening Lösen Déblocage Desbloqueo		Prestazioni Performances Leistungen Performances Prestaciones		Pressioni superficiali Surface pressures Oberflächendrucke Pressions de surface Presiones superficiales	
	d	D	H	H1	H2	NV	Tv (Nm)	N° viti / No. of screws Schraubenanzahl Nombre de vis Numero de tornillos	NV	N° viti / No. of screws Schraubenanzahl Nombre de vis Numero de tornillos	Mt (Nm)	Ta (KN)	Pa (N/mm <sup>2</sup> )	Pm (N/mm <sup>2</sup> )
KLEE025	25	55	46	40	32	M6x35	17	6	M6x35	3	799	64	314	107
KLEE028	28	55	46	40	32	M6x35	17	6	M6x35	3	895	64	281	107
KLEE030	30	55	46	40	32	M6x35	17	6	M6x35	3	959	64	262	107
KLEE035	35	60	60	54	44	M6x45	17	7	M6x45	3	1306	75	185	83
KLEE038	38	75	62	54	44	M8x50	41	7	M8x50	3	2567	135	308	121
KLEE040	40	75	62	54	44	M8x50	41	7	M8x50	3	2702	135	293	121
KLEE042	42	75	62	54	44	M8x50	41	7	M8x50	3	2837	135	279	121
KLEE045	45	75	62	54	44	M8x50	41	7	M8x50	3	3040	135	260	121
KLEE048	48	80	72	64	56	M8x55	41	8	M8x55	4	3707	154	216	102
KLEE050	50	80	72	64	56	M8x55	41	8	M8x55	4	3861	154	207	102
KLEE055	55	85	72	64	56	M8x55	41	9	M8x55	4	4779	174	212	108
KLEE060	60	90	72	64	56	M8x55	41	10	M8x55	4	5793	193	216	113
KLEE065	65	95	72	64	56	M8x55	41	10	M8x55	4	6276	193	199	107
KLEE070	70	110	88	78	70	M10x60	83	10	M10x60	4	10951	313	235	120
KLEE075	75	115	88	78	70	M10x60	83	10	M10x60	4	11733	313	220	115
KLEE080	80	120	88	78	70	M10x60	83	11	M10x60	4	13768	344	227	121
KLEE085	85	125	88	78	70	M10x60	83	12	M10x60	5	15959	376	233	127
KLEE090	90	130	88	78	70	M10x60	83	12	M10x60	5	16898	376	220	122
KLEE095	95	135	88	78	70	M10x60	83	12	M10x60	5	17837	376	208	117
KLEE100	100	145	112	100	90	M12x80	145	11	M12x80	4	25029	501	211	113
KLEE110	110	155	112	100	90	M12x80	145	12	M12x80	5	30039	546	209	115
KLEE120	120	165	112	100	90	M12x80	145	14	M12x80	6	38226	637	224	127
KLEE130	130	180	130	116	104	M14x90	230	12	M14x90	5	48270	743	201	117
KLEE140	140	190	130	116	104	M14x90	230	14	M14x90	7	60654	866	217	129
KLEE150	150	200	130	116	104	M14x90	230	15	M14x90	7	69628	928	217	132
KLEE160	160	210	130	116	104	M14x90	230	16	M14x90	7	79220	990	217	134
KLEE170	170	225	164	148	134	M16x120	360	14	M16x120	7	100851	1186	206	116
KLEE180	180	235	164	148	134	M16x120	360	15	M16x120	7	114414	1271	208	119
KLEE190	190	250	164	148	134	M16x120	360	16	M16x120	7	128814	1356	210	119
KLEE200	200	260	164	148	134	M16x120	360	16	M16x120	7	135594	1356	200	115
KLEE220	220	285	164	148	134	M16x120	360	18	M16x120	8	167805	1526	204	118

**KLFF**

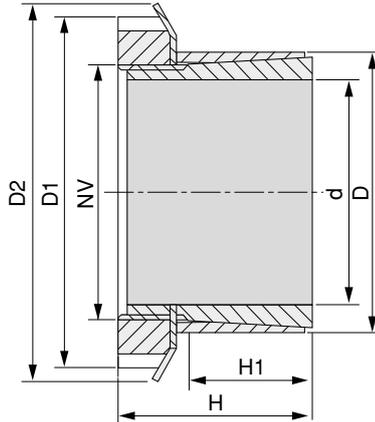

**KLFC**

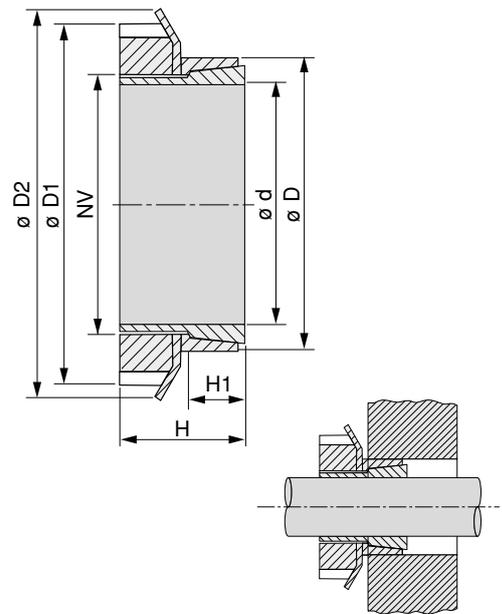

**Materiale C 45 E**  
**UNI EN 10083-1**  
Dimensioni valide per gruppo non precaricato

**Material C 45 E**  
**UNI EN 10083-1**  
Dimentionis before mounting

**Werkstoff C 45 E**  
**UNI EN 10083-1**  
Abmessungen vor Montage

**Matière C 45 E**  
**UNI EN 10083-1**  
Dimensions avant le montage

**Material C 45 E**  
**UNI EN 10083-1**  
Dimensiones antes del montaje

Nostro codice Our code Unser Kode Notre code Nuestro codigo	Dimensioni Dimentionis Abmessungen Dimensions Dimensiones						Serraggio Blocking power Befestigungskraft Force de blocage Fuerza de bloqueo		Prestazioni Performances Leistungen Performances Prestaciones		Pressioni superficiali Surface pressures Oberflächendrucke Pressions de surface Presiones superficiales	
	d	D	D1	D2	H	H1	NV	Tv (Nm)	Mt (Nm)	Ta (KN)	Pa (N/mm <sup>2</sup> )	Pm (N/mm <sup>2</sup> )
KLFF015	15	25	32	34	31	20	M20 x 1	95	77	9	91	55
KLFF018	18	30	38	41	33	21	M25 x 1,5	160	125	13	98	59
KLFF019	19	30	38	41	33	21	M25 x 1,5	160	132	13	93	59
KLFF020	20	30	38	41	33	21	M25 x 1,5	160	139	13	88	59
KLFF024	24	35	45	48	38	25	M30 x 1,5	220	202	15	74	51
KLFF025	25	35	45	48	38	25	M30 x 1,5	220	210	15	71	51
KLFF028	28	40	52	55	44	28	M35 x 1,5	340	312	20	76	53
KLFF030	30	40	52	55	44	28	M35 x 1,5	340	335	20	71	53
KLFF035	35	45	58	61	45	28	M40 x 1,5	480	483	25	75	58
KLFF040	40	50	65	67	46	28	M45 x 1,5	680	696	31	82	66
KLFF045	45	55	70	73	47	28	M50 x 1,5	870	902	36	84	69
KLFF050	50	60	75	81	47	28	M55 x 2	970	1014	37	77	64
KLFF055	55	65	80	87	48	28	M60 x 2	1100	1158	38	73	61
KLFF060	60	70	85	93	50	28	M65 x 2	1300	1379	41	73	62

Nostro codice Our code Unser Kode Notre code Nuestro codigo	Dimensioni Dimentionis Abmessungen Dimensions Dimensiones						Serraggio Blocking power Befestigungskraft Force de blocage Fuerza de bloqueo		Prestazioni Performances Leistungen Performances Prestaciones		Pressioni superficiali Surface pressures Oberflächendrucke Pressions de surface Presiones superficiales	
	d	D	D1	D2	H	H1	NV	Tv (Nm)	Mt (Nm)	Ta (KN)	Pa (N/mm <sup>2</sup> )	Pm (N/mm <sup>2</sup> )
KLFC014	14	25	32	34	17	6,5	M20 x 1	95	52	7	241	135
KLFC015	15	25	32	34	17	6,5	M20 x 1	95	56	7	225	135
KLFC016	16	25	32	34	17	6,5	M20 x 1	95	60	7	211	135
KLFC018	18	30	38	41	17,5	6,5	M25 x 1,5	160	91	10	256	154
KLFC019	19	30	38	41	18	6,5	M25 x 1,5	160	96	10	242	154
KLFC020	20	30	38	41	18	6,5	M25 x 1,5	160	102	10	230	154
KLFC024	24	35	45	48	18	6,5	M30 x 1,5	220	139	12	218	150
KLFC025	25	35	45	48	18	6,5	M30 x 1,5	220	144	12	210	150
KLFC028	28	40	52	55	18	6,5	M35 x 1,5	340	215	15	248	174
KLFC030	30	40	52	55	20	8	M35 x 1,5	340	230	15	188	141
KLFC035	35	45	58	61	22	8	M40 x 1,5	480	331	19	199	155
KLFC040	40	50	65	67	25	10	M45 x 1,5	680	477	24	176	141
KLFC045	45	55	70	73	26	10	M50 x 1,5	870	617	27	180	147
KLFC048	48	60	75	81	26	10	M55 x 2	970	669	28	171	137
KLFC050	50	60	75	81	26	10	M55 x 2	970	697	28	164	137
KLFC055	55	65	80	87	27	12	M60 x 2	1100	796	29	129	109
KLFC060	60	70	85	93	29	12	M65 x 2	1300	946	32	129	111
KLFC070	70	84	98	104	31,5	13,5	M75 x 2	2000	1433	41	128	106

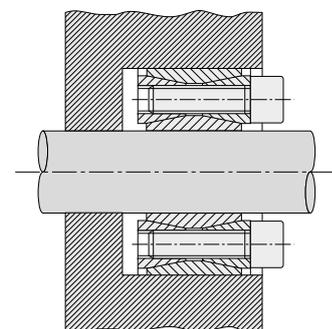
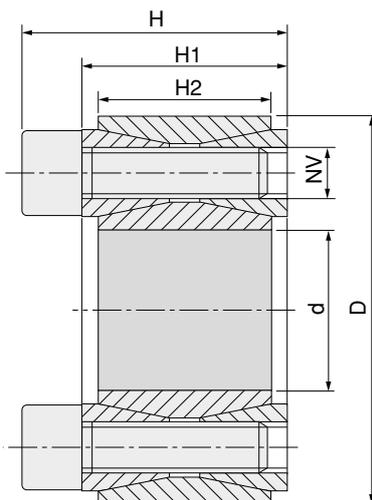

**Materiale C 45 E**  
**UNI EN 10083-1**  
 Dimensioni valide per  
 gruppo non precaricato

**Material C 45 E**  
**UNI EN 10083-1**  
 Dimentionis before  
 mounting

**Werkstoff C 45 E**  
**UNI EN 10083-1**  
 Abmessungen vor Montage

**Matière C 45 E**  
**UNI EN 10083-1**  
 Dimensions avant le  
 montage

**Material C 45 E**  
**UNI EN 10083-1**  
 Dimensiones antes del  
 montaje

Nostro codice Our code Unser Kode Notre code Nuestro codigo	Dimensioni Dimentionis Abmessungen Dimensions Dimensiones					Serraggio Tightening Befestigung Serrage Fijación			Sbloccaggio Loosening Lösen Déblocage Desbloqueo		Prestazioni Performances Leistungen Performances Prestaciones		Pressioni superficiali Surface pressures Oberflächendrucke Pressions de surface Presiones superficiales	
	d	D	H	H1	H2	NV	Tv (Nm)	N° viti / No. of screws Schraubenanzahl Nombre de vis Numero de tornillos	NV	N° viti / No. of screws Schraubenanzahl Nombre de vis Numero de tornillos	Mt (Nm)	Ta (KN)	Pa (N/mm <sup>2</sup> )	Pm (N/mm <sup>2</sup> )
KLGG019	19	47	26	20	17	M6x18	14,9	8	M8	2	298	31	286	116
KLGG020	20	47	26	20	17	M6x18	14,9	8	M8	2	313	31	272	116
KLGG022	22	47	26	20	17	M6x18	14,9	8	M8	2	345	31	247	116
KLGG024	24	50	26	20	17	M6x18	14,9	9	M8	3	424	35	255	123
KLGG025	25	50	26	20	17	M6x18	14,9	9	M8	3	441	35	245	123
KLGG028	28	55	26	20	17	M6x18	14,9	10	M8	3	549	39	243	124
KLGG030	30	55	26	20	17	M6x18	14,9	10	M8	3	588	39	227	124
KLGG032	32	60	26	20	17	M6x18	14,9	12	M8	4	758	47	255	136
KLGG035	35	60	26	20	17	M6x18	14,9	12	M8	4	822	47	233	136
KLGG038	38	65	26	20	17	M6x18	14,9	14	M8	4	1042	55	250	146
KLGG040	40	65	26	20	17	M6x18	14,9	14	M8	4	1097	55	238	146
KLGG042	42	75	32	24	20	M8x22	35,0	12	M10	4	1740	83	291	163
KLGG045	45	75	32	24	20	M8x22	35,0	12	M10	4	1864	83	271	163
KLGG048	48	80	32	24	20	M8x22	35,0	12	M10	4	1988	83	254	153
KLGG050	50	80	32	24	20	M8x22	35,0	12	M10	4	2071	83	244	153
KLGG055	55	85	32	24	20	M8x22	35,0	14	M10	4	2658	97	259	168
KLGG060	60	90	32	24	20	M8x22	35,0	14	M10	4	2900	64	238	158
KLGG065	65	95	32	24	20	M8x22	35,0	16	M10	4	3587	110	250	171
KLGG070	70	110	38	28	24	M10x25	69,0	14	M12	4	5345	153	268	171
KLGG075	75	115	38	28	24	M10x25	69,0	14	M12	4	5727	153	250	163
KLGG080	80	120	38	28	24	M10x25	69,0	14	M12	4	6108	153	235	156
KLGG085	85	125	38	28	24	M10x25	69,0	16	M12	4	7417	175	252	172
KLGG090	90	130	38	28	24	M10x25	69,0	16	M12	4	7854	175	238	165
KLGG095	95	135	38	28	24	M10x25	69,0	18	M12	4	9326	196	254	179
KLGG100	100	145	45	33	26	M12x30	123,3	14	M14	4	11362	227	258	178
KLGG110	110	155	45	33	26	M12x30	123,3	14	M14	4	12498	227	234	166
KLGG120	120	165	45	33	26	M12x30	123,3	16	M14	4	15578	260	245	178
KLGG130	130	180	50	38	34	M12x35	123,3	20	M14	4	21095	325	217	156
KLGG140	140	190	50	38	34	M12x35	123,3	22	M14	4	24993	357	221	163
KLGG150	150	200	50	38	34	M12x35	123,3	24	M14	4	29217	390	225	169
KLGG160	160	210	50	38	34	M12x35	123,3	26	M14	4	33756	422	229	174
KLGG170	170	225	58	44	38	M14x40	187,0	22	M16	4	39483	465	212	160
KLGG180	180	235	58	44	38	M14x40	187,0	24	M16	4	45606	507	218	167
KLGG190	190	250	66	52	46	M14x45	187,0	28	M16	4	56163	591	199	152
KLGG200	200	260	66	52	46	M14x45	187,0	30	M16	4	63342	633	203	156

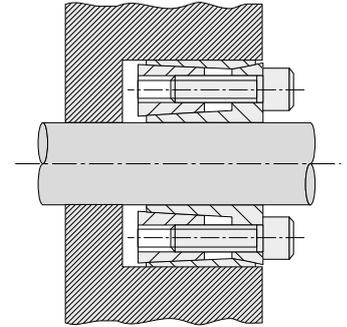
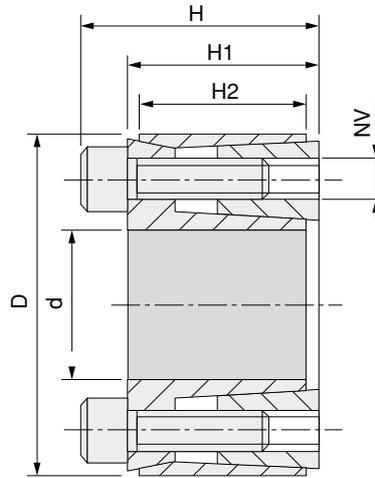

**Materiale C 45 E**  
**UNI EN 10083-1**  
Dimensioni valide per  
gruppo non precaricato

**Material C 45 E**  
**UNI EN 10083-1**  
Dimentionis before  
mounting

**Werkstoff C 45 E**  
**UNI EN 10083-1**  
Abmessungen vor Montage

**Matière C 45 E**  
**UNI EN 10083-1**  
Dimensions avant le  
montage

**Material C 45 E**  
**UNI EN 10083-1**  
Dimensiones antes del  
montaje

Nostro codice Our code Unser Kode Notre code Nuestro código	Dimensioni Dimentions Abmessungen Dimensions Dimensiones					Serraggio Tightening Befestigung Serrage Fijación			Sbloccaggio Loosening Lösen Déblocage Desbloqueo		Prestazioni Performances Leistungen Performances Prestaciones		Pressioni superficiali Surface pressures Oberflächendrücke Pressions de surface Presiones superficiales	
	d	D	H	H1	H2	NV	Tv (Nm)	N° viti / No. of screws Schraubenanzahl Nombre de vis Numero de tornillos	NV	N° viti / No. of screws Schraubenanzahl Nombre de vis Numero de tornillos	Mt (Nm)	Ta (kN)	Pa (N/mm <sup>2</sup> )	Pm (N/mm <sup>2</sup> )
KLHH018	18	40	24	18	14,7	M6x16	17	4	M6x16	2	165	18,0	185	83
KLHH019	19	41	24	18	14,7	M6x16	17	4	M6x16	2	174	18,0	176	81
KLHH020	20	42	24	18	14,7	M6x16	17	4	M6x16	2	183	18,0	167	79
KLHH024	24	46	24	18	14,7	M6x16	17	6	M6x16	3	329	27,0	209	109
KLHH025	25	47	24	18	14,7	M6x16	17	6	M6x16	3	343	27,0	200	106
KLHH028	28	50	24	18	14,7	M6x16	17	6	M6x16	3	384	27,0	179	100
KLHH030	30	52	24	18	14,7	M6x16	17	6	M6x16	3	412	27,0	167	96
KLHH035	35	57	28	22	18,0	M6x18	17	6	M6x18	3	480	27,0	117	78
KLHH038	38	60	28	22	18,0	M6x18	17	8	M6x18	4	695	36,5	143	91
KLHH040	40	62	28	22	18,0	M6x18	17	8	M6x18	4	732	36,5	136	88
KLHH042	42	70	36	28	23,5	M8x25	42	8	M8x25	4	1427	68,0	185	111
KLHH045	45	73	36	28	23,5	M8x25	42	8	M8x25	4	1529	68,0	172	106
KLHH048	48	76	36	28	23,5	M8x25	42	8	M8x25	4	1631	68,0	161	102
KLHH050	50	78	36	28	23,5	M8x25	42	8	M8x25	4	1699	68,0	155	99
KLHH055	55	83	36	28	23,5	M8x25	42	8	M8x25	4	1869	68,0	141	93
KLHH060	60	88	36	28	23,5	M8x25	42	8	M8x25	4	2039	68,0	129	88
KLHH070	70	105	45	35	30,0	M10x30	83	8	M10x30	4	3759	107,0	137	91
KLHH080	80	115	45	35	30,0	M10x30	83	8	M10x30	4	4296	107,0	120	83

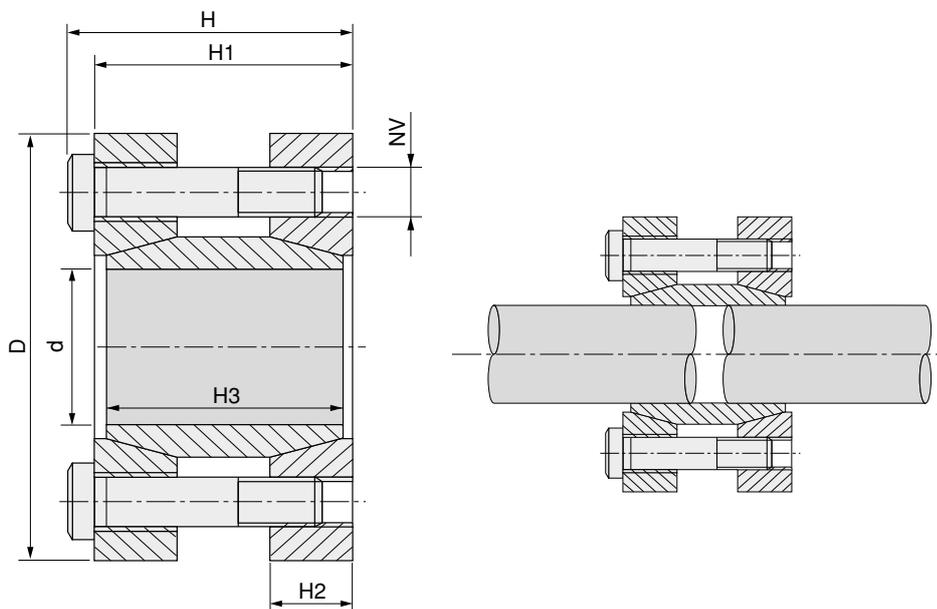

**Materiale C 45 E**  
**UNI EN 10083-1**  
Dimensioni valide per  
gruppo non precaricato

**Material C 45 E**  
**UNI EN 10083-1**  
Dimentions before  
mounting

**Werkstoff C 45 E**  
**UNI EN 10083-1**  
Abmessungen vor Montage

**Matière C 45 E**  
**UNI EN 10083-1**  
Dimensions avant le  
montage

**Material C 45 E**  
**UNI EN 10083-1**  
Dimensiones antes del  
montaje

Nostro codice Our code Unser Kode Notre code Nuestro codigo	Dimensioni Dimensions Abmessungen Dimensions Dimensiones						Serraggio Tightening Befestigung Serrage Fijación				Prestazioni Performances Leistungen Performances Prestaciones		Pressioni superficiali Surface pressures Oberflächendrücke Pressions de surface Presiones superficiales
	d	D	H	H1	H2	H3	NV	Tv (Nm)	N° viti / No. of screws Schraubenanzahl Nombre de vis Numero de tornillos	Mt (Nm)	Ta (KN)	Pa (N/mm <sup>2</sup> )	
KLMM017	17	50	56	50	16,0	44	M6 x 45	17	4	179	21	166	
KLMM018	18	50	56	50	16,0	44	M6 x 45	17	4	190	21	157	
KLMM019	19	50	56	50	16,0	44	M6 x 45	17	4	200	21	149	
KLMM020	20	50	56	50	16,0	44	M6 x 45	17	4	211	21	141	
KLMM024	24	55	66	60	18,5	54	M6 x 55	17	6	378	32	144	
KLMM025	25	55	66	60	18,5	54	M6 x 55	17	6	394	32	138	
KLMM028	28	60	66	60	18,5	54	M6 x 55	17	6	442	32	123	
KLMM030	30	60	66	60	18,5	54	M6 x 55	17	6	473	32	115	
KLMM032	32	63	66	60	18,5	54	M6 x 55	17	6	505	32	108	
KLMM035	35	75	83	75	22,0	67	M8 x 70	42	4	682	39	98	
KLMM038	38	75	83	75	22,0	67	M8 x 70	42	4	741	39	90	
KLMM040	40	75	83	75	22,0	67	M8 x 70	42	4	780	39	86	
KLMM042	42	78	83	75	22,0	67	M8 x 70	42	4	819	39	82	
KLMM045	45	85	93	85	24,5	76	M8 x 80	42	6	1317	59	101	
KLMM048	48	90	93	85	24,5	76	M8 x 80	42	6	1405	59	95	
KLMM050	50	90	93	85	24,5	76	M8 x 80	42	6	1463	59	91	
KLMM055	55	94	93	85	24,5	76	M8 x 80	42	8	2147	78	110	
KLMM060	60	100	93	85	24,5	76	M8 x 80	42	8	2343	78	101	
KLMM065	65	105	93	85	24,5	76	M8 x 80	42	8	2538	78	93	
KLMM070	70	115	110	100	29,0	90	M10 x 95	83	8	4321	123	116	

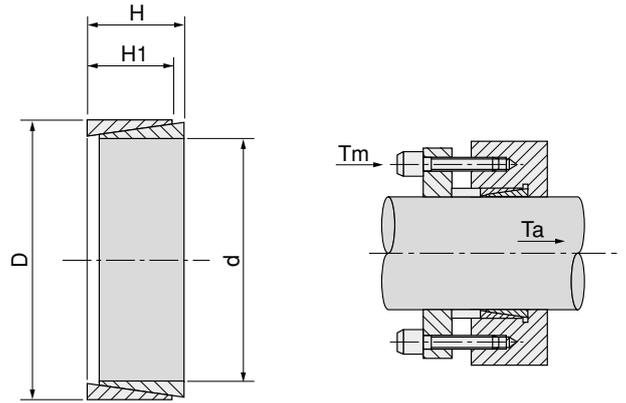

esempio di montaggio / example of assembly  
 Beispiel für die Montage / exemple de montage / ejemplo de montaje

**Materiale C 45 E**  
**UNI EN 10083-1**  
 Dimensioni valide per  
 gruppo non precaricato

**Material C 45 E**  
**UNI EN 10083-1**  
 Dimentionis before  
 mounting

**Werkstoff C 45 E**  
**UNI EN 10083-1**  
 Abmessungen vor Montage

**Matière C 45 E**  
**UNI EN 10083-1**  
 Dimensions avant le  
 montage

**Material C 45 E**  
**UNI EN 10083-1**  
 Dimensiones antes del  
 montaje

Nostro codice Our code Unser Kode Notre code Nuestro codigo	Dimensioni / Dimentions Abmessungen / Dimensions Dimensiones				Prestazioni / Performances Leistungen / Performances Prestaciones			Pressioni superficiali / Surface pressures Oberflächendrücke / Pressions de surface Presiones superficiales	
	d	D	H	H1	Mt (Nm)	Ta (KN)	Tm (KN)	Pa (N/mm <sup>2</sup> )	Pm (N/mm <sup>2</sup> )
KLNN008	8	11	4,5	3,7	4,2	1,06	5,0	100	70
KLNN009	9	12	4,5	3,7	5,8	1,29	13,3	100	79
KLNN010	10	13	4,5	3,7	7,6	1,53	14,4	100	86
KLNN012	12	15	4,5	3,7	9,9	1,65	14,5	100	80
KLNN014	14	18	6,3	5,3	18,9	2,70	23,8	100	77
KLNN015	15	19	6,3	5,3	22,1	2,94	24,3	100	79
KLNN016	16	20	6,3	5,3	25,4	3,18	24,5	100	81
KLNN018	18	22	6,3	5,3	31,8	3,53	25,3	100	82
KLNN019	19	24	6,3	5,3	35,8	3,76	29,7	100	80
KLNN020	20	25	6,3	5,3	38,8	3,88	30,1	100	79
KLNN022	22	26	6,3	5,3	47,9	4,35	28,9	100	86
KLNN024	24	28	6,3	5,3	56,4	4,70	30,0	100	86
KLNN025	25	30	6,3	5,3	61,7	4,94	32,4	100	84
KLNN028	28	32	6,3	5,3	77,4	5,53	32,6	100	88
KLNN030	30	35	6,3	5,3	88,2	5,88	35,5	100	86
KLNN032	32	36	6,3	5,3	100,0	6,23	36,7	100	88
KLNN035	35	40	7,0	6,0	136,0	7,76	45,7	100	88
KLNN038	38	44	7,0	6,0	161,0	8,47	49,7	100	87
KLNN040	40	45	8,0	6,6	195,0	9,80	58,8	100	89
KLNN042	42	48	8,0	6,6	215,0	10,20	62,6	100	87
KLNN045	45	52	10,0	8,6	323,0	14,30	92,2	100	87
KLNN048	48	55	10,0	8,6	367,0	15,30	94,6	100	88
KLNN050	50	57	10,0	8,6	397,0	15,90	96,5	100	88
KLNN055	55	62	10,0	8,6	479,0	17,40	101,8	100	88
KLNN060	60	68	12,0	10,4	691,0	23,00	133,4	100	88
KLNN065	65	73	12,0	10,4	814,0	25,00	140,4	100	89
KLNN070	70	79	14,0	12,2	1107,0	31,60	176,0	100	89
KLNN075	75	84	14,0	12,2	1266,0	33,80	189,6	100	89
KLNN080	80	91	17,0	15,0	1769,0	44,20	251,0	100	89
KLNN090	90	101	17,0	15,0	2244,0	49,90	272,4	100	89
KLNN100	100	114	21,0	18,7	3452,0	69,00	377,7	100	89
KLNN110	110	124	21,0	18,7	4178,0	76,00	415,0	100	89
KLNN120	120	134	21,0	18,7	4967,0	82,80	440,2	100	89
KLNN130	130	148	28,0	25,3	7896,0	121,00	654,2	100	89
KLNN140	140	158	28,0	25,3	9146,0	131,00	689,0	100	89
KLNN150	150	168	28,0	25,3	10505,0	140,00	727,5	100	89



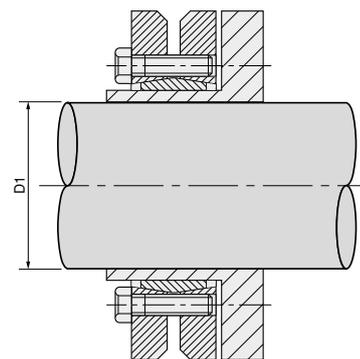
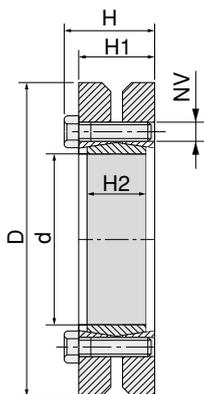

**Materiale C 45 E**  
**UNI EN 10083-1**  
Dimensioni valide per  
gruppo non precaricato

**Material C 45 E**  
**UNI EN 10083-1**  
Dimentions before  
mounting

**Werkstoff C 45 E**  
**UNI EN 10083-1**  
Abmessungen vor Montage

**Matière C 45 E**  
**UNI EN 10083-1**  
Dimensions avant le  
montage

**Material C 45 E**  
**UNI EN 10083-1**  
Dimensiones antes del  
montaje

Nostro codice Our code Unser Kode Notre code Nuestro codigo	Dimensioni / Dimentions Abmessungen / Dimensions Dimensiones						Serraggio / Tightening Befestigung / Serrage Fijación			Prestazioni / Performances Leistungen / Performances Prestaciones		Pressioni superficiali / Surface pressures Oberflächendrücke / Pressions de surface / Presiones superficiales
	d	D	D1	H	H1	H2	NV	Tv (Nm)	N° viti / No. of screws Schraubenanzahl Nombre de vis Numero de tornillos	Mt (Nm)	Ta (KN)	Pa (N/mm <sup>2</sup> )
<b>KLPP024</b>	24	50	19 20 21	23,0	19,5	14	M5 x 18	4	6	216 265 314	23,0 27,0 30,0	272
<b>KLPP030</b>	30	60	24 25 26	25,0	21,5	16	M5 x 18	4	7	372 421 461	31,0 34,0 36,0	221
<b>KLPP036</b>	36	72	26 28 30	27,5	23,5	18	M6 x 20	12	5	471 550 713	36,3 39,3 47,5	292
<b>KLPP044</b>	44	80	32 35 36	29,5	25,5	20	M6 x 20	12	7	925 1175 1275	57,8 67,1 70,8	301
<b>KLPP050</b>	50	90	38 40 42	31,5	27,5	22	M6 x 25	12	8	1313 1638 1925	69,1 81,9 91,7	275
<b>KLPP055</b>	55	100	42 45 48	34,5	30,5	23	M6 x 25	12	8	1450 1900 2350	69,0 84,4 97,9	239
<b>KLPP062</b>	62	110	48 50 52	34,5	30,5	23	M6 x 25	12	10	2775 3275 3613	116,0 131,0 139,0	265
<b>KLPP068</b>	68	115	50 55 60	34,5	30,5	23	M6 x 25	12	10	2500 3125 3938	100,0 114,0 131,0	242
<b>KLPP075</b>	75	138	55 60 65	37,8	32,5	25	M8 x 30	30	7	3125 4000 4938	114,0 133,0 152,0	259
<b>KLPP080</b>	80	145	60 65 70	37,8	32,5	25	M8 x 30	30	7	4000 4875 5750	133,0 150,0 164,0	243
<b>KLPP090</b>	90	155	65 70 75	44,3	39,0	30	M8 x 35	30	10	5938 7500 9063	183,0 214,0 242,0	257
<b>KLPP100</b>	100	170	70 75 80	49,3	44,0	34	M8 x 35	30	12	8625 9375 11250	246,0 250,0 281,0	245
<b>KLPP110</b>	110	185	75 80 85	56,4	50,0	39	M10 x 40	59	9	9000 11250 13500	240,0 281,0 318,0	232
<b>KLPP125</b>	125	215	85 90 95	60,4	54,0	42	M10 x 40	59	12	13750 16250 18750	324,0 361,0 395,0	253
<b>KLPP140</b>	140	230	95 100 105	68,0	60,5	46	M12 x 45	100	10	18875 22000 25125	397,0 440,0 479,0	251
<b>KLPP155</b>	155	265	105 110 115	72,0	64,5	50	M12 x 50	100	12	27500 31250 35000	524,0 568,0 609,0	250
<b>KLPP165</b>	165	290	115 120 125	81,0	71,0	56	M16 x 55	250	8	38750 43750 48750	674,0 729,0 780,0	263

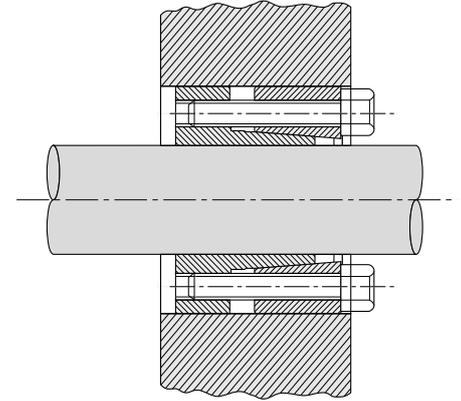
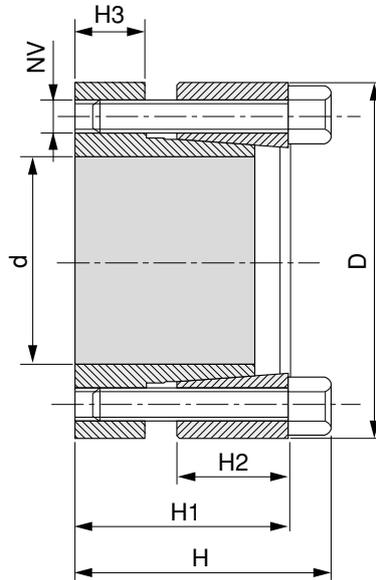

**Materiale C 45 E**  
**UNI EN 10083-1**  
Dimensioni valide per  
gruppo non precaricato

**Material C 45 E**  
**UNI EN 10083-1**  
Dimentionis before  
mounting

**Werkstoff C 45 E**  
**UNI EN 10083-1**  
Abmessungen vor Montage

**Matière C 45 E**  
**UNI EN 10083-1**  
Dimensions avant le  
montage

**Material C 45 E**  
**UNI EN 10083-1**  
Dimensiones antes del  
montaje

Nostro codice Our code Unser Kode Notre code Nuestro codigo	Dimensioni Dimensions Abmessungen Dimensions Dimensiones						Serraggio Tightening Befestigung Serrage Fijación			Sbloccaggio Loosening Lösen Déblocage Desbloqueo		Prestazioni Performances Leistungen Performances Prestaciones		Pressioni superficiali Surface pressures Oberflächendrucke Pressions de surface Presiones superficiales	
	d	D	H	H1	H2	H3	NV	Tv (Nm)	N° viti / No. of screws Schraubenanzahl Nombre de vis Numero de tornillos	NV	N° viti / No. of screws Schraubenanzahl Nombre de vis Numero de tornillos	Mt (Nm)	Ta (KN)	Pa (N/mm <sup>2</sup> )	Pm (N/mm <sup>2</sup> )
KLRR020	20	47	34	28	14	10	M6x25	13	5	M6x25	3	294	29	328	139
KLRR022	22	47	34	28	14	10	M6x25	13	5	M6x25	3	323	29	298	139
KLRR024	24	50	34	28	14	10	M6x25	14	6	M6x25	3	455	38	353	169
KLRR025	25	50	34	28	14	10	M6x25	14	6	M6x25	3	474	38	338	169
KLRR030	30	55	34	28	14	10	M6x25	14	6	M6x25	3	569	38	282	154
KLRR035	35	60	34	28	14	10	M6x25	14	8	M6x25	4	885	51	322	188
KLRR038	38	65	34	28	14	10	M6x25	14	8	M6x25	4	961	51	297	174
KLRR040	40	65	34	28	14	10	M6x25	14	8	M6x25	4	1012	51	282	174
KLRR042	42	75	43	35	18	12	M8x30	32	7	M8x30	4	1594	76	313	176
KLRR045	45	75	43	35	18	12	M8x30	32	7	M8x30	4	1707	76	293	176
KLRR050	50	80	43	35	18	12	M8x30	32	7	M8x30	4	1897	76	263	165
KLRR055	55	85	43	35	18	12	M8x30	32	8	M8x30	4	2387	87	274	177
KLRR060	60	90	43	35	18	12	M8x30	32	8	M8x30	4	2604	87	251	167
KLRR065	65	95	43	35	18	12	M8x30	32	9	M8x30	4	3172	98	260	178
KLRR070	70	110	56	46	24	16	M10x40	65	8	M10x40	4	4937	141	262	167

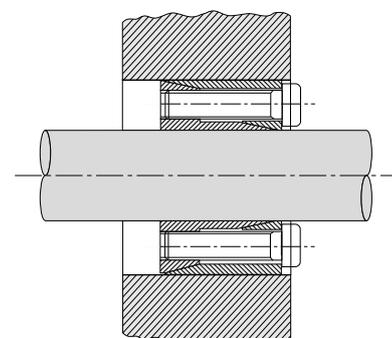
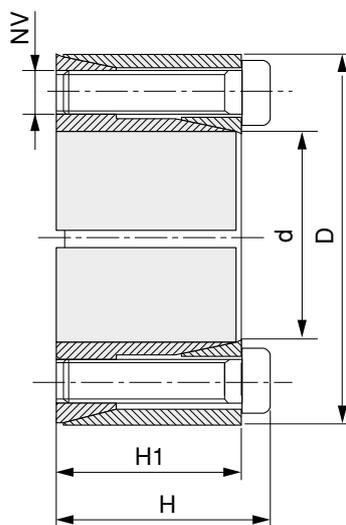

**Materiale C 45 E**  
**UNI EN 10083-1**  
Dimensioni valide per  
gruppo non precaricato

**Material C 45 E**  
**UNI EN 10083-1**  
Dimentionis before  
mounting

**Werkstoff C 45 E**  
**UNI EN 10083-1**  
Abmessungen vor Montage

**Matière C 45 E**  
**UNI EN 10083-1**  
Dimensions avant le  
montage

**Material C 45 E**  
**UNI EN 10083-1**  
Dimensiones antes del  
montaje

Nostro codice Our code Unser Kode Notre code Nuestro codigo	Dimensioni Dimentions Abmessungen Dimensions Dimensiones				Serraggio Tightening Befestigung Serrage Fijación			Sbloccaggio Loosening Lösen Déblocage Desbloqueo		Prestazioni Performances Leistungen Performances Prestaciones		Pressioni superficiali Surface pressures Oberflächendrücke Pressions de surface Presiones superficiales	
	d	D	H	H1	NV	Tv (Nm)	N° viti / No. of screws Schraubenzahl Nombre de vis Numero de tornillos	NV	N° viti / No. of screws Schraubenzahl Nombre de vis Numero de tornillos	Mt (Nm)	Ta (KN)	Pa (N/mm <sup>2</sup> )	Pm (N/mm <sup>2</sup> )
KLSS010	10	20	15,5	13	M2,5x12	1,2	4	M2,5x12	2	19	3,8	89	45
KLSS011	11	22	15,5	13	M2,5x12	1,2	4	M2,5x12	2	21	3,8	81	41
KLSS012	12	22	15,5	13	M2,5x12	1,2	4	M2,5x12	2	23	3,8	75	41
KLSS014	14	26	20,0	17	M3x16	2,1	4	M3x16	2	39	5,5	71	38
KLSS015	15	28	20,0	17	M3x16	2,1	4	M3x16	2	42	5,5	66	35
KLSS016	16	32	21,0	17	M4x16	4,9	4	M4x16	2	77	9,6	107	54
KLSS017	17	35	25,0	21	M4x20	4,9	4	M4x20	2	82	9,6	81	40
KLSS018	18	35	25,0	21	M4x20	4,9	4	M4x20	2	87	9,6	77	40
KLSS019	19	35	25,0	21	M4x20	4,9	4	M4x20	2	91	9,6	73	40
KLSS020	20	38	26,0	21	M5x20	10,0	4	M5x30	2	157	15,7	113	60
KLSS022	22	40	26,0	21	M5x20	10,0	4	M5x20	2	173	15,7	103	57
KLSS024	24	47	32,0	26	M6x24	17,0	4	M6x24	2	268	22,3	110	56
KLSS025	25	47	32,0	26	M6x24	17,0	4	M6x24	2	279	22,3	105	56
KLSS028	28	50	32,0	26	M6x24	17,0	6	M6x24	3	468	33,5	141	79
KLSS030	30	55	32,0	26	M6x24	17,0	6	M6x24	3	502	33,5	132	72
KLSS032	32	55	32,0	26	M6x24	17,0	6	M6x24	3	535	33,5	123	72
KLSS035	35	60	37,0	31	M6x28	17,0	8	M6x28	4	781	44,6	125	73
KLSS038	38	65	37,0	31	M6x28	17,0	8	M6x28	4	848	44,6	115	67
KLSS040	40	65	37,0	31	M6x28	17,0	8	M6x28	4	892	44,6	110	67
KLSS042	42	75	44,0	36	M8x34	41,0	6	M8x34	3	1272	60,6	122	68
KLSS045	45	75	44,0	36	M8x34	41,0	6	M8x34	3	1363	60,6	113	68
KLSS048	48	80	44,0	36	M8x34	41,0	8	M8x34	4	1938	80,8	142	85
KLSS050	50	80	44,0	36	M8x34	41,0	8	M8x34	4	2019	80,8	136	85

**Cremagliera intestata per montaggio continuo**  
**Spurgear racks suitable for continuous mounting**  
**Zahnstangen für fortlaufende Montage**  
**Cremailleres raboutables pour montage en continue**  
**Cremalleras mecanizadas para montaje continuo**

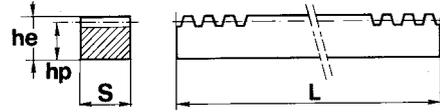

Il grado di qualità della dentatura va da 8 a 9 ed è a DIN 3962/63/67	The quality grade of the tooththing is from 8 to 9 at DIN 3962/63/67	Verzahnungsqualität 8 bis 9 nach DIN 3962/63/67	Le degré de qualité de la denture va de 8 à 9 selon DIN 3962/63/67	El grado de calidad del dentado va desde 8 a 9 y es según DIN 3962/63/67
Dentatura diritta	Straight tooththing	Gerade Verzahnung	Denture droite	Dentado derecho
Angolo pressione 20°	Angle of pressure 20°	Eingriffswinkel 20°	Angle de pression 20°	Ángulo de presión 20°
Materiale C 45 E UNI EN 10083-1	Material C 45 E UNI EN 10083-1	Werkstoff C 45 E UNI EN 10083-1	Matière C 45 E UNI EN 10083-1	Material C 45 E UNI EN 10083-1

Mod.	hp	he x S	L							
			500		1000		2000		3000	
			Cod.	Kg	Cod.	Kg	Cod.	Kg	Cod.	Kg
1	14,0	15 x 15	CR 26050	0,820	CR 26100	1,500	CR 26200	3,100	CR 26300	4,900
1,5	15,5	17 x 17	CR 27050	1,000	CR 27100	2,000	CR 27200	4,000	CR 27300	6,100
2	18,0	20 x 20	CR 28050	1,400	CR 28100	2,700	CR 28200	5,400	CR 28300	8,400
2,5	22,5	25 x 25	CR 29050	2,100	CR 29100	4,300	CR 29200	8,600	CR 29300	11,900
3	27,0	30 x 30	CR 30050	3,100	CR 30100	6,300	CR 30200	12,500	CR 30300	18,600
4	18	22 x 22	CR 37050	1,400	CR 37100	3,250	CR 37200	6,800		
4	21,0	25 x 25	CR 36050	1,800	CR 36100	3,650	CR 36200	7,300	CR 36300	10,900
4	26,0	30 x 30	CR 33050	3,050	CR 33100	6,000	CR 33200	11,900	CR 33300	18,100
4	36,0	40 x 40	CR 31050	5,500	CR 31100	11,100	CR 31200	22,000	CR 31300	31,300
5	45,0	50 x 50	CR 32050	8,300	CR 32100	17,500	CR 32200	34,600	CR 32300	45,300
6	54	60 x 60	CR 34050	12,650	CR 34100	25,000	CR 34200	51,000		
8	72,0	80 x 80	CR 39050	22,400	CR 39100	45,000	CR 39200	90,000		

Cremagliera rettificata sui fianchi	Racks with ground finished faces	Zahnstangen mit geschliffenen seitenflaechen	Cremailleres avec faces rectifiees	Cremalleras con lados rectificados
-------------------------------------	----------------------------------	--	------------------------------------	------------------------------------

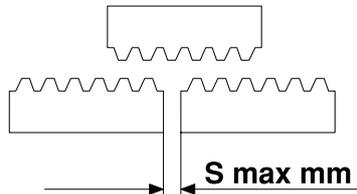

**Dati tecnici      Technical specifications      Technische daten      Donnees techniques      Datos tecnicos**

Mod.	Passo / Pitch Teilung / Pas Paso	S	L							
			500		1000		2000		3000	
			Z	Lr	Z	Lr	Z	Lr	Z	Lr
1	3,1416	0,5	159	499,51	319	1002,17	637	2001,20	955	3000,23
1,5	4,7124	0,6	106	499,51	213	1003,74	425	2002,77	637	3001,80
2	6,2832	0,6	80	502,66	160	1005,31	319	2004,34	478	3003,37
2,5	7,8540	0,7	64	502,66	128	1005,31	255	2002,77	382	3000,23
3	9,4248	0,8	53	499,51	107	1008,45	213	2007,48	319	3006,51
4	12,5664	0,8	40	502,66	80	1005,31	160	2010,62	239	3003,37
5	15,7080	1,0	32	502,66	64	1005,31	128	2010,62	191	3000,23
6	18,8496	1,0	27	508,94	54	1017,88	107	2016,91		
8	25,1328	1,0	20	502,66	40	1005,31	80	2010,62		

**Cremagliera per cancelli, viti, rondelle e distanziali inclusi**  
**Racks for sliding gates, complete with screws washers and spacers**  
**Zahnstangen für Schiebetore, komplett mit Schrauben, Federringen und Abstandhaltern**  
**Crémaillères pour portails coulissants. Vis, rondelles et entretoises incluses**  
**Cremalleras para puertas correderas. Tornillos, arandelas y espaciadores incluidos**

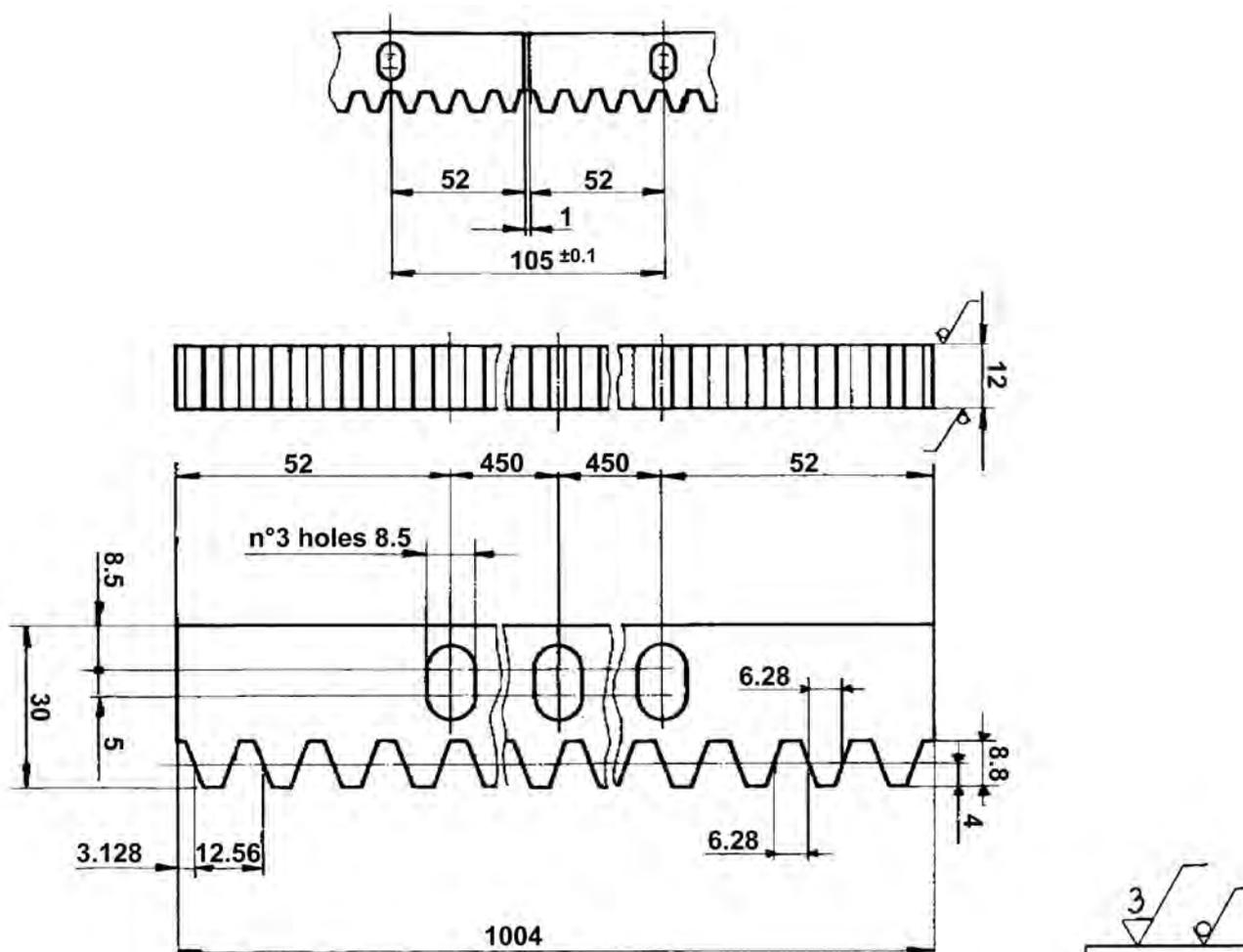

Cod. CRE3012

Passo 12.566 mm

Pitch 12.566 mm

Teilung 12.566 mm

Pas 12.566 mm

Paso 12.566 mm

Modulo = 4

Module = 4

Modul = 4

Modul = 4

Modulo = 4

**Il grado di qualità della dentatura va da 8 a 9 ed è a DIN 3962/63/67**

**The quality grade of the toothing is from 8 to 9 at DIN 3962/63/67**

**Verzahnungsqualität 8 bis 9 nach DIN 3962/63/67**

**Le degré de qualité de la denture va de 8 à 9 selon DIN 3962/63/67**

**El grado de calidad del dentado va desde 8 a 9 y es según DIN 3962/63/67**

**Dentatura diritta**

**Straight toothing**

**Gerade Verzahnung**

**Denture droite**

**Dentado derecho**

**Angolo pressione 20°**

**Angle of pressure 20°**

**Eingriffswinkel 20°**

**Angle de pression 20°**

**Ángulo de presión 20°**

**Materiale C 45 E UNI EN 10083-1**

**Material C 45 E UNI EN 10083-1**

**Werkstoff C 45 E UNI EN 10083-1**

**Matière C 45 E UNI EN 10083-1**

**Material C 45 E UNI EN 10083-1**

**Trattamento superficiale: Zincatura**

**Surface treatment: Zinc plating**

**Oberflächenbehandlung: Verzinken**

**Traitement de surface: Zingage**

**Tratamiento superficial: Cincado**

# Pignoni a modulo / Spur gears with side hub / Zahnräder mit Nabe

## Roues cylindriques avec moyeu lateral / Ruedas dentadas cilindricas con cubo lateral

Spessore dente "h" per modulo: **1** = 15 mm  
 Tooth width "h" for module: **1,5** = 17 mm  
 Zahnbreite "h" für Modul: **2** = 20 mm  
 Largeur denture "h" pour forme: **2,5** = 25 mm  
 Ancho dente "h" para modulo: **3** = 30 mm  
**4** = 40 mm  
**5** = 50 mm  
**6** = 60 mm

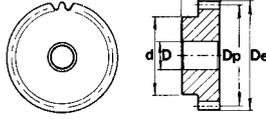

Altezza totale "H" per modulo: **1** = 25 mm  
 Through bore "H" for module: **1,5** = 30 mm  
 Gesamtbreite "H" für Modul: **2** = 35 mm  
 Hauteur totale "H" pour: **2,5** = 40 mm  
 Altura total "H" para Modulo: **3** = 50 mm  
**4** = 60 mm  
**5** = 75 mm  
**6** = 80 mm



**Angolo di pressione 20°**  
**Materiale C 45 E**  
**UNI EN 10083-1**

**Pressure angle 20°**  
**Material C 45 E**  
**UNI EN 10083-1**

**Eingriffswinkel 20°**  
**Werkstoff C 45 E**  
**UNI EN 10083-1**

**Angle de pression 20°**  
**Matière C 45 E**  
**UNI EN 10083-1**

**Angulo de presion 20°**  
**Material C 45 E**  
**UNI EN 10083-1**

Z	Mod. 1					Mod. 1,5					Mod. 2				
	cod.	D <sub>e</sub>	D <sub>p</sub>	d	D	cod.	D <sub>e</sub>	D <sub>p</sub>	d	D	cod.	D <sub>e</sub>	D <sub>p</sub>	d	D
12	PM 26012	14	12	9	5	PM 27012	21,0	18,0	14	8	PM 28012	28	24	18	10
13	PM 26013	15	13	10	5	PM 27013	22,5	19,5	14	8	PM 28013	30	26	19	10
14	PM 26014	16	14	10	5	PM 27014	24,0	21,0	17	8	PM 28014	32	28	20	10
15	PM 26015	17	15	12	6	PM 27015	25,5	22,5	18	8	PM 28015	34	30	22	10
16	PM 26016	18	16	13	6	PM 27016	27,0	24,0	20	8	PM 28016	36	32	24	10
17	PM 26017	19	17	14	8	PM 27017	28,5	25,5	20	8	PM 28017	38	34	25	10
18	PM 26018	20	18	15	8	PM 27018	30,0	27,0	20	8	PM 28018	40	36	25	10
19	PM 26019	21	19	15	8	PM 27019	31,5	28,5	20	8	PM 28019	42	38	25	10
20	PM 26020	22	20	16	8	PM 27020	33,0	30,0	25	8	PM 28020	44	40	30	10
21	PM 26021	23	21	16	8	PM 27021	34,5	31,5	25	10	PM 28021	46	42	30	12
22	PM 26022	24	22	18	8	PM 27022	36,0	33,0	25	10	PM 28022	48	44	30	12
23	PM 26023	25	23	18	8	PM 27023	37,5	34,5	25	10	PM 28023	50	46	30	12
24	PM 26024	26	24	20	8	PM 27024	39,0	36,0	25	10	PM 28024	52	48	35	12
25	PM 26025	27	25	20	8	PM 27025	40,5	37,5	25	10	PM 28025	54	50	35	12
26	PM 26026	28	26	20	8	PM 27026	42,0	39,0	30	12	PM 28026	56	52	40	12
27	PM 26027	29	27	20	8	PM 27027	43,5	40,5	30	12	PM 28027	58	54	40	12
28	PM 26028	30	28	20	8	PM 27028	45,0	42,0	30	12	PM 28028	60	56	40	12
29	PM 26029	31	29	20	8	PM 27029	46,5	43,5	30	12	PM 28029	62	58	40	14
30	PM 26030	32	30	20	8	PM 27030	48,0	45,0	30	12	PM 28030	64	60	40	14
31	PM 26031	33	31	25	10	PM 27031	49,5	46,5	35	12	PM 28031	66	62	45	14
32	PM 26032	34	32	25	10	PM 27032	51,0	48,0	35	12	PM 28032	68	64	45	14
33	PM 26033	35	33	25	10	PM 27033	52,5	49,5	35	12	PM 28033	70	66	45	14
34	PM 26034	36	34	25	10	PM 27034	54,0	51,0	35	12	PM 28034	72	68	45	14
35	PM 26035	37	35	25	10	PM 27035	55,5	52,5	35	12	PM 28035	74	70	45	14
36	PM 26036	38	36	25	10	PM 27036	57,0	54,0	35	12	PM 28036	76	72	45	14
37	PM 26037	39	37	25	10	PM 27037	58,5	55,5	40	12	PM 28037	78	74	50	14
38	PM 26038	40	38	25	10	PM 27038	60,0	57,0	40	12	PM 28038	80	76	50	14
39	PM 26039	41	39	25	10	PM 27039	61,5	58,5	40	12	PM 28039	82	78	50	14
40	PM 26040	42	40	25	10	PM 27040	63,0	60,0	40	12	PM 28040	84	80	50	14
41	PM 26041	43	41	30	10	PM 27041	64,5	61,5	50	14	PM 28041	86	82	60	16
42	PM 26042	44	42	30	10	PM 27042	66,0	63,0	50	14	PM 28042	88	84	60	16
43	PM 26043	45	43	30	10	PM 27043	67,5	64,5	50	14	PM 28043	90	86	60	16
44	PM 26044	46	44	30	10	PM 27044	69,0	66,0	50	14	PM 28044	92	88	60	16
45	PM 26045	47	45	30	10	PM 27045	70,5	67,5	50	14	PM 28045	94	90	60	16
46	PM 26046	48	46	30	10	PM 27046	72,0	69,0	50	14	PM 28046	96	92	60	16
47	PM 26047	49	47	30	10	PM 27047	73,5	70,5	50	14	PM 28047	98	94	60	16
48	PM 26048	50	48	30	10	PM 27048	75,0	72,0	50	14	PM 28048	100	96	70	16
49	PM 26049	51	49	30	10	PM 27049	76,5	73,5	50	14	PM 28049	102	98	70	16
50	PM 26050	52	50	30	12	PM 27050	78,0	75,0	50	14	PM 28050	104	100	70	16
51	PM 26051	53	51	40	12	PM 27051	79,5	76,5	60	15	PM 28051	106	102	70	20
52	PM 26052	54	52	40	12	PM 27052	81,0	78,0	60	15	PM 28052	108	104	70	20
53	PM 26053	55	53	40	12	PM 27053	82,5	79,5	60	15	PM 28053	110	106	70	20
54	PM 26054	56	54	40	12	PM 27054	84,0	81,0	60	15	PM 28054	112	108	70	20
55	PM 26055	57	55	40	12	PM 27055	85,5	82,5	60	15	PM 28055	114	110	70	20
56	PM 26056	58	56	40	12	PM 27056	87,0	84,0	60	15	PM 28056	116	112	70	20
57	PM 26057	59	57	40	12	PM 27057	88,5	85,5	60	15	PM 28057	118	114	70	20
58	PM 26058	60	58	40	12	PM 27058	90,0	87,0	60	15	PM 28058	120	116	70	20
59	PM 26059	61	59	40	12	PM 27059	91,5	88,5	60	15	PM 28059	122	118	70	20
60	PM 26060	62	60	40	12	PM 27060	93,0	90,0	60	15	PM 28060	124	120	70	20
61	PM 26061	63	61	50	12	PM 27061	94,5	91,5	70	20	PM 28061	126	122	80	20
62	PM 26062	64	62	50	12	PM 27062	96,0	93,0	70	20	PM 28062	128	124	80	20
63	PM 26063	65	63	50	12	PM 27063	97,5	94,5	70	20	PM 28063	130	126	80	20
64	PM 26064	66	64	50	12	PM 27064	99,0	96,0	70	20	PM 28064	132	128	80	20
65	PM 26065	67	65	50	12	PM 27065	100,5	97,5	70	20	PM 28065	134	130	80	20
66	PM 26066	68	66	50	12	PM 27066	102,0	99,0	70	20	PM 28066	136	132	80	20
67	PM 26067	69	67	50	12	PM 27067	103,5	100,5	70	20	PM 28067	138	134	80	20
68	PM 26068	70	68	50	12	PM 27068	105,0	102,0	70	20	PM 28068	140	136	80	20
69	PM 26069	71	69	50	12	PM 27069	106,5	103,5	70	20	PM 28069	142	138	80	20
70	PM 26070	72	70	50	12	PM 27070	108,0	105,0	70	20	PM 28070	144	140	80	20
72	PM 26072	74	72	50	12	PM 27072	111,0	144,0	80	20	PM 28072	148	144	80	20
75	PM 26075	77	75	50	12										
76	PM 26076	78	76	50	12										
80	PM 26080	82	80	50	12										
90	PM 26090	92	90	50	12										
100	PM 26100	102	100	60	12										

**Pignoni a modulo / Spur gears with side hub / Zahnräder mit Nabe**  
**Roues cylindriques avec moyeu lateral / Ruedas dentadas cilíndricas con cubo lateral**



Z	Mod. 2,5					Mod. 3					Mod. 4				
	cod.	D <sub>e</sub>	D <sub>p</sub>	d	D	cod.	D <sub>e</sub>	D <sub>p</sub>	d	D	cod.	D <sub>e</sub>	D <sub>p</sub>	d	D
12	PM 29012	35,0	30,0	22	10	PM 30012	42	36	25	12	PM 31012	56	48	35	14
13	PM 29013	37,5	32,5	25	10	PM 30013	45	39	25	12	PM 31013	60	52	40	14
14	PM 29014	40,0	35,0	28	10	PM 30014	48	42	30	12	PM 31014	64	56	45	14
15	PM 29015	42,5	37,5	30	10	PM 30015	51	45	35	12	PM 31015	68	60	45	14
16	PM 29016	45,0	40,0	32	12	PM 30016	54	48	38	15	PM 31016	72	64	50	15
17	PM 29017	47,5	42,5	35	12	PM 30017	57	51	42	15	PM 31017	76	68	50	15
18	PM 29018	50,0	45,0	35	12	PM 30018	60	54	45	15	PM 31018	80	72	50	15
19	PM 29019	52,5	47,5	35	12	PM 30019	63	57	45	15	PM 31019	84	76	60	15
20	PM 29020	55,0	50,0	40	14	PM 30020	66	60	45	15	PM 31020	88	80	60	15
21	PM 29021	57,5	52,5	40	14	PM 30021	69	63	45	15	PM 31021	92	84	70	20
22	PM 29022	60,0	55,0	45	14	PM 30022	72	66	50	15	PM 31022	96	88	70	20
23	PM 29023	62,5	57,5	45	14	PM 30023	75	69	50	15	PM 31023	100	92	75	20
24	PM 29024	65,0	60,0	45	14	PM 30024	78	72	50	16	PM 31024	104	96	75	20
25	PM 29025	67,5	62,5	50	14	PM 30025	81	75	60	16	PM 31025	108	100	75	20
26	PM 29026	70,0	65,0	50	14	PM 30026	84	78	60	16	PM 31026	112	104	75	20
27	PM 29027	72,5	67,5	50	14	PM 30027	87	81	60	16	PM 31027	116	108	75	20
28	PM 29028	75,0	70,0	50	14	PM 30028	90	84	60	16	PM 31028	120	112	75	20
29	PM 29029	77,5	72,5	50	14	PM 30029	93	87	60	16	PM 31029	124	116	75	20
30	PM 29030	80,0	75,0	55	16	PM 30030	96	90	60	16	PM 31030	128	120	75	20
31	PM 29031	82,5	77,5	55	16	PM 30031	99	93	70	20	PM 31031	132	124	80	20
32	PM 29032	85,0	80,0	55	16	PM 30032	102	96	70	20	PM 31032	136	128	80	20
33	PM 29033	87,5	82,5	55	16	PM 30033	105	99	70	20	PM 31033	140	132	80	20
34	PM 29034	90,0	85,0	55	16	PM 30034	108	102	70	20	PM 31034	144	136	80	20
35	PM 29035	92,5	87,5	60	16	PM 30035	111	105	70	20	PM 31035	148	140	80	20
36	PM 29036	95,0	90,0	60	16	PM 30036	114	108	70	20	PM 31036	152	144	80	20
37	PM 29037	97,5	92,5	60	16	PM 30037	117	111	80	20	PM 31037	156	148	80	20
38	PM 29038	100,0	95,0	60	16	PM 30038	120	114	80	20	PM 31038	160	152	80	25
39	PM 29039	102,5	97,5	60	16	PM 30039	123	117	80	20	PM 31039	164	156	80	25
40	PM 29040	105,0	100,0	70	20	PM 30040	126	120	80	20	PM 31040	168	160	80	25
41	PM 29041	107,5	102,5	70	20	PM 30041	129	123	90	20					
42	PM 29042	110,0	105,0	70	20	PM 30042	132	126	90	20					
43	PM 29043	112,5	107,5	70	20	PM 30043	135	129	90	20					
44	PM 29044	115,0	110,0	70	20	PM 30044	138	132	90	20					
45	PM 29045	117,5	112,5	70	20	PM 30045	141	135	90	20	PM 31045	188	180	80	25
46	PM 29046	120,0	115,0	70	20	PM 30046	144	138	90	20					
47	PM 29047	122,5	117,5	80	20	PM 30047	147	141	90	20					
48	PM 29048	125,0	120,0	80	20	PM 30048	150	144	100	20	PM 31048	200	192	80	25
49	PM 29049	127,5	122,5	80	20	PM 30049	153	147	100	20					
50	PM 29050	130,0	125,0	80	20	PM 30050	156	150	100	20	PM 31050	208	200	80	25
51	PM 29051	132,5	127,5	90	20										
52	PM 29052	135,0	130,0	90	20										
53	PM 29053	137,5	132,5	90	20										
54	PM 29054	140,0	135,0	90	20	PM 30054	168	162	100	20					
55	PM 29055	142,5	137,5	90	20	PM 30055	171	165	100	20					
56	PM 29056	145,0	140,0	100	20	PM 30056	174	168	100	20					
57	PM 29057	147,5	142,5	100	20	PM 30057	177	171	100	20					
58	PM 29058	150,0	145,0	100	20										
59	PM 29059	152,5	147,5	100	20										
60	PM 29060	155,0	150,0	100	20	PM 30060	186	180	100	20	PM 31060	248	240	100	25
62	PM 29062	160,0	155,0	100	20	PM 30062	192	186	100	20					
63	PM 29063	162,5	157,5	100	20										
65	PM 29065	167,5	162,5	100	20	PM 30065	201	195	100	20	PM 31065	268	260	100	25
67	PM 29067	172,5	167,5	100	20										
70	PM 29070	180,0	175,0	100	20										

Z	Mod. 5					Mod. 6				
	cod.	D <sub>e</sub>	D <sub>p</sub>	d	D	cod.	D <sub>e</sub>	D <sub>p</sub>	d	D
12	PM 32012	70	60	45	16	PM 34012	84	72	54	20
13	PM 32013	75	65	50	16					
14	PM 32014	80	70	55	20	PM 34014	96	84	65	20
15	PM 32015	85	75	60	20	PM 34015	102	90	70	20
16	PM 32016	90	80	65	20	PM 34016	108	96	75	20
17	PM 32017	95	85	70	20					
18	PM 32018	100	90	70	20	PM 34018	120	108	80	20
19	PM 32019	105	95	70	20					
20	PM 32020	110	100	80	20	PM 34020	132	120	90	20
21	PM 32021	115	105	80	20					
22	PM 32022	120	110	80	25					
23	PM 32023	125	115	90	25	PM 34023	150	138	110	25
24	PM 32024	130	120	90	25	PM 34024	156	144	110	25
25	PM 32025	135	125	90	25	PM 34025	162	150	110	25
26	PM 32026	140	130	100	25					
27	PM 32027	145	135	100	25					
28	PM 32028	150	140	100	25					
29	PM 32029	155	145	100	25					
30	PM 32030	160	150	100	25	PM 34030	192	180	110	25
32	PM 32032	170	160	110	25					
36	PM 32036	190	180	110	25					
38	PM 32038	200	190	110	30					
40	PM 32040	210	200	110	30	PM 34040	252	240	120	25
42	PM 32042	220	210	120	25					
55	PM 32055	285	275	120	30					
60	PM 32060	310	300	120	30					

## Corone a modulo / Spur gears without side hub Zahnräder ohne Nabe / Roues cylindriques sans moyeu lateral Ruedas dentadas cilíndricas sin cubo lateral

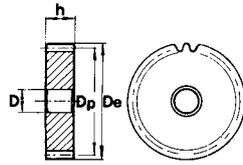

Spessore dente "h" per modulo:     **1** = 15 mm  
 Tooth width "h" for module:       **1,5** = 17 mm  
 Zahnbreite "h" für Modul:         **2** = 20 mm  
 Largeur denture "h" pour forme:   **2,5** = 25 mm  
 Ancho dente "h" para modulo:      **3** = 30 mm  
   **4** = 40 mm  
   **5** = 50 mm  
   **6** = 60 mm

**Angolo di pressione 20°**  
**Materiale C 45 E**  
**UNI EN 10083-1**

**Pressure angle 20°**  
**Material C 45 E**  
**UNI EN 10083-1**

**Eingriffswinkel 20°**  
**Werkstoff C 45 E**  
**UNI EN 10083-1**

**Angle de pression 20°**  
**Matière C 45 E**  
**UNI EN 10083-1**

**Angulo de presión 20°**  
**Material C 45 E**  
**UNI EN 10083-1**

Z	Mod. 1					Mod. 1,5					Mod. 2					Mod. 2,5				
	cod.	D <sub>e</sub>	D <sub>p</sub>	d	D	cod.	D <sub>e</sub>	D <sub>p</sub>	d	D	cod.	D <sub>e</sub>	D <sub>p</sub>	d	D	cod.	D <sub>e</sub>	D <sub>p</sub>	d	D
60	CM 26060	62	60	-	12											CM 29065	167,5	162,5	-	20
65																CM 29070	180,0	175,0	-	20
70	CM 26070	72	70	-	12											CM 29072	185,0	180,0	-	20
72	CM 26072	74	72	-	12	CM 27072	111,0	108,0	-	20	CM 28072	148	144	-	20	CM 29075	192,5	187,5	-	20
75	CM 26075	77	75	-	12	CM 27075	115,5	112,5	-	20	CM 28075	154	150	-	20	CM 29076	195,0	190,0	-	20
76	CM 26076	78	76	-	12	CM 27076	117,0	114,0	-	20	CM 28076	156	152	-	20	CM 29080	205,0	200,0	-	25
80	CM 26080	82	80	-	12	CM 27080	123,0	120,0	-	20	CM 28080	164	160	-	20	CM 29085	217,5	212,5	-	25
85	CM 26085	87	85	-	12	CM 27085	130,5	127,5	-	20	CM 28085	174	170	-	20	CM 29090	230,0	225,0	-	25
90	CM 26090	92	90	-	12	CM 27090	138,0	135,0	-	20	CM 28090	184	180	-	20	CM 29095	242,5	237,5	-	25
95	CM 26095	97	95	-	12	CM 27095	145,5	142,5	-	20	CM 28095	194	190	-	20	CM 29100	255,0	250,0	-	25
100	CM 26100	102	100	-	12	CM 27100	153,0	150,0	-	20	CM 28100	204	200	-	20	CM 29110	280,0	275,0	-	25
110	CM 26110	112	110	-	12	CM 27110	168,0	165,0	-	20	CM 28110	224	220	-	20	CM 29114	290,0	285,0	-	25
114	CM 26114	116	114	-	12	CM 27114	174,0	171,0	-	20	CM 28114	232	228	-	20	CM 29120	305,0	300,0	-	25
120	CM 26120	122	120	-	12	CM 27120	183,0	180,0	-	20	CM 28120	244	240	-	20	CM 29127	322,5	317,5	-	25
127	CM 26127	129	127	-	12	CM 27127	193,5	190,5	-	20	CM 28127	258	254	-	20					

Z	Mod. 3					Mod. 4					Mod. 5					Mod. 6				
	cod.	D <sub>e</sub>	D <sub>p</sub>	d	D	cod.	D <sub>e</sub>	D <sub>p</sub>	d	D	cod.	D <sub>e</sub>	D <sub>p</sub>	d	D	cod.	D <sub>e</sub>	D <sub>p</sub>	d	D
30																CM 34030	192	180	-	25
32											CM 32032	170	160	-	25	CM 34032	204	192	-	25
35											CM 32035	185	175	-	25					
38						CM 31038	160	152	-	25	CM 32038	200	190	-	30	CM 34038	240	220	-	25
40						CM 31040	168	160	-	25	CM 32040	210	200	-	30	CM 34040	252	240	-	25
45						CM 31045	188	180	-	25	CM 32045	235	225	-	30					
48	CM 30048	150	144	-	25	CM 31048	200	192	-	25	CM 32048	250	240	-	30					
50	CM 30050	156	150	-	25	CM 31050	208	200	-	25	CM 32050	260	250	-	30					
52	CM 30052	162	156	-	25	CM 31052	216	208	-	25	CM 32052	270	260	-	30					
55	CM 30055	171	165	-	25	CM 31055	228	220	-	25	CM 32055	285	275	-	30					
57	CM 30057	177	171	-	25	CM 31057	236	228	-	25	CM 32057	295	285	-	30					
60	CM 30060	186	180	-	25	CM 31060	248	240	-	25	CM 32060	310	300	-	30					
65	CM 30065	201	195	-	25	CM 31065	268	260	-	25	CM 32065	335	325	-	30					
70	CM 30070	216	210	-	25	CM 31070	288	280	-	25	CM 32070	360	350	-	30					
72	CM 30072	222	216	-	25															
75	CM 30075	231	225	-	25	CM 31075	308	300	-	25	CM 32075	385	375	-	30					
76	CM 30076	234	228	-	25	CM 31076	312	304	-	25	CM 32076	390	380	-	30					
80	CM 30080	246	240	-	25	CM 31080	328	320	-	25	CM 32080	410	400	-	30					
85	CM 30085	261	255	-	25	CM 31085	348	340	-	25	CM 32085	435	425	-	30					
90	CM 30090	276	270	-	25	CM 31090	368	360	-	25	CM 32090	460	450	-	30					
95	CM 30095	291	285	-	25	CM 31095	388	380	-	25	CM 32095	485	475	-	30					
100	CM 30100	306	300	-	25	CM 31100	408	400	-	25	CM 32100	510	500	-	30					
110	CM 30110	336	330	-	25	CM 31110	448	440	-	25	CM 32110	560	550	-	30					
114	CM 30114	348	342	-	30	CM 31114	464	456	-	25	CM 32114	580	570	-	30					
120	CM 30120	366	360	-	30															
127	CM 30127	387	381	-	30															



**Coppie coniche ad assi normali - tipo A / Bevel gear pairs with usual axes - type A**  
**Kegelräder mit Normalachsen - typ A / Couples coniques avec essieux normaux - type A**  
**Engranajes conicos a ejes normales - tipo A**



Angolo di pressione 20°  
 Materiale C 45 E  
 UNI EN 10083-1

Pressure angle 20°  
 Material C 45 E  
 UNI EN 10083-1

Eingriffswinkel 20°  
 Werkstoff C 45 E  
 UNI EN 10083-1

Angle de pression 20°  
 Matière C 45 E  
 UNI EN 10083-1

Angulo de presion 20°  
 Material C 45 E  
 UNI EN 10083-1

**Rapporto 1:1 / Ratio 1:1 / Untersetzung 1:1 / Rapport 1:1 / Relaciones 1:1**  
**UNI 6588**

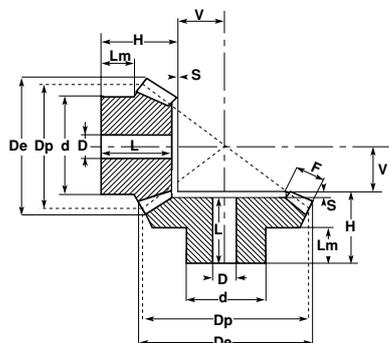

M	Z	cod.	De	Dp	H	F	d	D	V	L	Lm	S
1,5	16	C27A161	26,1	24,0	18,9	6	20,3	8	7,10	16,9	12,00	2,0
	20	C27A201	32,1	30,0	20,0	10	22,0	10	7,40	18,0	8,50	2,0
	22	C27A221	35,1	33,0	20,0	10	25,0	10	8,75	18,0	8,25	2,0
	25	C27A251	39,6	37,5	23,0	10	28,0	10	11,09	21,0	12,00	2,0
	30	C27A301	47,1	45,0	25,0	12	30,0	12	13,35	22,5	12,00	2,5
2	16	C28A161	34,8	32,0	23,5	8	25,3	10	9,50	20,5	14,00	3,0
	20	C28A201	42,8	40,0	25,0	12	32,0	10	10,78	22,0	12,00	3,0
	22	C28A221	46,8	44,0	25,0	12	36,0	10	12,70	22,0	11,70	3,0
	25	C28A251	52,8	50,0	28,0	14	40,0	12	14,28	25,0	12,30	3,0
	30	C28A301	62,8	60,0	30,0	16	50,0	12	17,78	27,0	12,80	3,0
2,5	16	C29A161	43,5	40,0	28,1	10	30,3	12	11,90	24,6	15,00	3,5
	20	C29A201	53,5	50,0	30,5	12	40,0	12	15,43	27,0	16,00	3,5
	22	C29A221	58,5	55,0	30,5	12	45,0	12	17,80	27,0	15,90	3,5
	25	C29A251	66,0	62,5	33,5	15	50,0	15	19,48	30,0	16,00	3,5
	30	C29A301	78,5	75,0	35,5	18	55,0	15	23,63	32,0	16,00	3,5
3	16	C30A161	52,2	48,0	31,7	12	40,3	15	14,30	27,7	18,00	4,0
	20	C30A201	64,2	60,0	35,0	18	45,0	15	16,00	31,0	13,60	4,0
	22	C30A221	70,2	66,0	35,0	18	50,0	15	19,00	31,0	13,00	4,0
	25	C30A251	79,2	75,0	38,0	20	55,0	15	22,00	34,0	16,00	4,0
	30	C30A301	94,2	90,0	40,0	22	60,0	20	28,00	36,0	17,00	4,0
3,5	16	C35A161	60,9	56,0	36,4	14	45,3	15	16,60	31,9	20,00	4,5
	20	C35A201	74,9	70,0	40,5	22	55,0	15	18,13	36,0	17,00	4,5
	22	C35A221	81,9	77,0	40,5	22	60,0	15	21,50	36,0	18,00	4,5
	25	C35A251	92,4	87,5	43,5	26	65,0	20	23,97	39,0	18,00	4,5
	30	C35A301	109,9	105,0	48,0	30	70,0	20	30,02	43,5	19,00	4,5
4	16	C31A161	69,6	64,0	44,3	15	50,3	15	19,70	39,3	25,00	5,0
	20	C31A201	85,6	80,0	43,0	25	60,0	18	20,74	38,0	18,00	5,0
	22	C31A221	93,6	88,0	43,0	25	65,0	18	24,70	38,0	18,00	5,0
	25	C31A251	105,6	100,0	45,0	28	70,0	20	28,50	40,0	18,00	5,0
	30	C31A301	125,6	120,0	48,0	32	80,0	25	35,67	43,0	16,00	5,0
4,5	16	C45A161	78,3	72,0	46,3	18	55,3	18	21,70	40,3	25,00	6,0
	20	C45A201	96,3	90,0	48,0	28	65,0	20	23,41	42,0	18,00	6,0
	22	C45A221	105,3	99,0	48,0	28	70,0	20	27,80	42,0	18,00	6,0
	25	C45A251	118,8	112,5	50,0	32	75,0	20	31,76	44,0	18,00	6,0
	30	C45A301	141,3	135,0	53,0	35	90,0	25	40,82	47,0	17,00	6,0
5	16	C32A161	87,0	80,0	48,9	18	60,3	20	25,10	42,4	24,19	6,5
	20	C32A201	107,1	100,0	50,5	30	70,0	20	26,86	44,0	18,50	6,5
	22	C32A221	117,1	110,0	50,5	30	80,0	20	31,70	44,0	18,50	6,5
	25	C32A251	132,1	125,0	53,5	34	90,0	20	36,36	47,0	18,00	6,5
	30	C32A301	157,1	150,0	56,5	38	110,0	30	45,97	50,0	18,00	6,5

**Rapporto 1:2 / Ratio 1:2 / Untersetzung 1:2 / Rapport 1:2 / Relaciones 1:2**  
**UNI 6588**

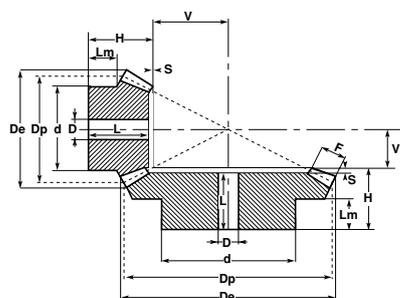

M	Z	cod.	De	Dp	H	F	d	D	V	L	Lm	S
1,5	16	C27A322	26,7	24	19,5	8	21	10	16,33	18	11,3	1,5
	32		49,3	48	20,0	8	32	12	7,45	17	10,0	3,0
2	16	C28 A322	35,6	32	23,0	10	26	10	22,41	21	12,2	2,0
	32		65,8	64	25,0	10	40	12	10,21	21	10,0	4,0
2,5	16	C29 A322	44,4	40	27,5	12	34	12	28,38	25	14,4	2,5
	32		82,2	80	26,0	12	50	15	13,10	20	10,0	6,0
3	16	C30A322	53,4	48	28,0	15	40	15	33,64	25	11,6	3,0
	32		98,7	96	30,0	15	60	15	15,31	24	10,0	6,0
3,5	16	C35A322	62,3	56	33,5	18	48	15	38,83	30	14,4	3,5
	32		115,1	112	31,0	18	70	20	17,77	24	10,0	7,0
4	16	C31A322	71,1	64	36,0	20	50	20	44,81	32	13,4	4,0
	32		131,6	128	32,0	20	80	20	20,42	24	10,0	8,0
4,5	16	C45A322	80,1	72	39,5	22	60	20	51,00	35	15,4	4,5
	32		148,0	144	36,0	22	90	25	23,21	27	10,0	9,0
5	16	C32A322	88,9	80	50,0	25	60	20	56,06	45	21,1	5,0
	32		164,5	160	38,0	25	100	25	25,52	28	10,0	10,0



**Coppie coniche ad assi normali - tipo B - esecuzione speciale**  
**Bevel gear pairs with usual axes - type B - special execution**  
**Kegelräder mit Normalachsen - typ B - Spezialausführung**  
**Couples coniques avec essieux normaux - type B - exécution spéciale**  
**Engranajes conicos a ejes normales - tipo B - ejecución especial**

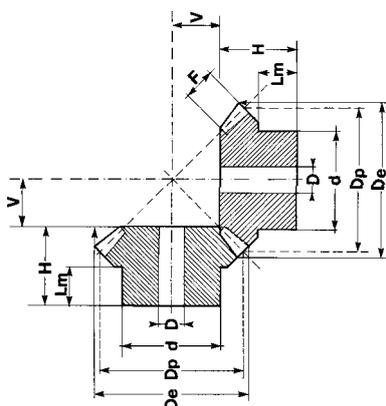

**Angolo di pressione 20°**    **Pressure angle 20°**    **Eingriffswinkel 20°**    **Angle de pression 20°**    **Angulo de presión 20°**  
**Materiale C 45 E**            **Material C 45 E**            **Werkstoff C 45 E**            **Matière C 45 E**            **Material C 45 E**  
**UNI EN 10083-1**            **UNI EN 10083-1**            **UNI EN 10083-1**            **UNI EN 10083-1**            **UNI EN 10083-1**

**Rapporto 1:1 / Ratio 1:1 / Untersetzung 1:1 / Rapport 1:1 / Relaciones 1:1**

M	Z	cod.	De	Dp	H	F	d	D	V	Lm
1	16	C26B161	17,4	16,0	11,20	4,0	13,3	4	4,80	6,5
	19	C26B191	20,4	19,0	11,80	4,0	15,3	4	6,20	6,5
	22	C26B221	23,4	22,0	12,80	4,7	16,3	5	7,20	6,5
	26	C26B261	27,4	26,0	13,30	5,5	20,3	5	8,70	7,0
	30	C26B301	31,4	30,0	16,00	6,4	20,3	5	10,00	8,0
1,5	16	C27B161	26,1	24,0	18,90	6,0	20,3	8	7,10	12,0
	19	C27B191	30,6	28,5	21,30	7,0	20,3	8	8,70	12,0
	22	C27B221	35,1	33,0	22,50	7,5	25,3	8	10,50	12,0
	26	C27B261	41,1	39,0	23,20	8,5	28,3	8	12,80	12,0
	30	C27B301	47,1	45,0	27,20	10,0	30,3	12	14,80	12,0
2	16	C28B161	34,8	32,0	23,50	8,0	25,3	8	9,50	14,0
	19	C28B191	40,8	38,0	24,20	9,0	25,3	8	11,80	12,0
	22	C28B221	46,8	44,0	27,90	10,0	30,3	12	14,10	14,0
	26	C28B261	54,8	52,0	31,40	12,0	35,3	12	16,60	14,0
	30	C28B301	62,8	60,0	34,10	13,0	40,3	14	19,90	17,0
2,5	16	C29B161	43,5	40,0	28,10	10,0	30,3	12	11,90	15,0
	19	C29B191	51,0	47,5	27,10	11,0	35,3	12	14,90	13,0
	22	C29B221	58,5	55,0	30,10	12,0	45,3	16	17,90	16,0
	26	C29B261	68,5	65,0	33,20	15,0	45,3	16	20,80	16,0
	30	C29B301	78,5	75,0	39,00	16,0	50,3	16	25,00	20,0
3	16	C30B161	52,5	48,0	31,70	12,0	40,3	12	14,30	18,0
	19	C30B191	61,2	57,0	36,00	13,0	40,3	14	18,00	17,0
	22	C30B221	70,2	66,0	36,90	15,0	50,3	16	21,10	17,0
	26	C30B261	82,2	78,0	38,40	17,0	50,3	16	25,60	18,0
	30	C30B301	94,2	90,0	43,80	19,0	60,3	20	30,20	22,0
3,5	16	C35B161	60,9	56,0	36,40	14,0	45,3	16	16,60	20,0
	19	C35B191	71,5	66,5	37,80	15,0	50,3	18	21,00	19,0
	22	C35B221	81,9	77,0	39,10	17,0	55,3	20	24,90	18,0
	26	C35B261	96,0	91,0	43,35	20,0	62,3	20	29,70	20,0
	30	C35B301	110,0	105,0	47,10	23,0	70,3	20	34,90	22,0
4	16	C31B161	69,7	64,0	44,30	15,0	50,3	16	19,70	25,0
	19	C31B191	81,7	76,0	44,40	18,0	55,3	20	23,60	22,0
	22	C31B221	93,7	88,0	45,90	20,0	60,3	20	28,10	22,0
	26	C31B261	109,7	104,0	48,00	25,0	70,3	20	34,00	22,0
	30	C31B301	125,7	120,0	54,20	26,0	80,3	25	39,80	25,0
4,5	16	C45B161	78,4	72,0	46,30	17,5	55,3	20	21,70	25,0
	19	C45B191	91,8	85,5	49,00	20,0	62,3	20	26,57	25,0
	22	C45B221	105,3	99,0	50,10	22,0	70,3	20	31,90	25,0
	26	C45B261	123,0	117,0	54,70	25,0	75,3	20	38,60	26,0
	30	C45B301	141,4	135,0	60,00	29,0	80,3	25	45,00	28,0
5	16	C32B161	87,1	80,0	48,90	18,0	60,3	20	25,10	25,0
	19	C32B191	102,1	95,0	52,20	22,0	60,3	20	29,80	25,0
	22	C32B221	117,1	110,0	58,20	24,0	80,3	25	35,80	30,0
	26	C32B261	137,1	130,0	62,70	29,0	80,3	25	42,30	30,0
	30	C32B301	157,1	150,0	68,90	32,0	80,3	30	50,10	35,0

**Coppie coniche ad assi normali - tipo B - esecuzione speciale**  
**Bevel gear pairs with usual axes - type B - special execution**  
**Kegelräder mit Normalachsen - typ B - Spezialausführung**  
**Couples coniques avec essieux normaux - type B - exécution spéciale**  
**Engranajes conicos a ejes normales - tipo B - ejecución especial**

**Angolo di pressione 20°**  
**Materiale C 45 E**  
**UNI EN 10083-1**

**Pressure angle 20°**  
**Material C 45 E**  
**UNI EN 10083-1**

**Eingriffswinkel 20°**  
**Werkstoff C 45 E**  
**UNI EN 10083-1**

**Angle de pression 20°**  
**Matière C 45 E**  
**UNI EN 10083-1**

**Angulo de presion 20°**  
**Material C 45 E**  
**UNI EN 10083-1**

**Rapporto 1:1,5 / Ratio 1:1,5 / Untersetzung 1:1,5 / Rapport 1:1,5 / Relaciones 1:1,5**

M	Z	cod.	D <sub>e</sub>	D <sub>p</sub>	H	F	d	D	V	L	Lm	S
1	16	C26B240	18,1	16	12,0	4,3	13,3	4	8,0		7,0	
	24		24,8	24	14,8	4,3	20,3	5	5,2	13,3	9,3	1,5
1,5	16	C27B240	27,1	24	20,3	8,0	20,3	8	10,7		11,8	
	24		37,2	36	24,9	8,0	28,3	8	7,1	22,7	16,0	2,2
2	16	C28B240	36,2	32	25,2	10,0	25,3	8	14,8		13,8	
	24		49,7	48	27,2	10,0	32,3	8	9,8	24,7	16,0	2,5
2,5	16	C29B240	45,2	40	30,8	13,0	32,3	12	18,2		16,4	
	24		62,1	60	34,0	13,0	45,3	16	12,0	30,8	20,0	3,2
3	16	C30B240	54,3	48	32,4	14,5	40,3	12	22,6		16,4	
	24		74,5	72	36,2	14,5	55,3	16	14,8	32,0	20,0	4,2
3,5	16	C35B240	63,3	56	40,4	18,0	45,3	16	25,6		20,4	
	24		86,9	84	44,2	18,0	55,3	20	16,8	40,0	25,0	4,2
4	16	C31B240	72,4	64	46,8	18,0	50,3	16	31,2		25,4	
	24		99,3	96	45,5	18,0	60,3	20	20,5	40,0	25,0	5,5
4,5	16	C45B240	81,4	72	47,6	20,0	60,3	20	35,4		25,1	
	24		111,7	108	57,8	20,0	80,3	25	23,2	51,3	35,0	6,5
5	16	C32B240	90,5	80	54,1	24,0	60,3	25	37,9		25,4	
	24		124,1	120	61,1	24,0	80,3	30	24,9	54,5	35,0	6,6

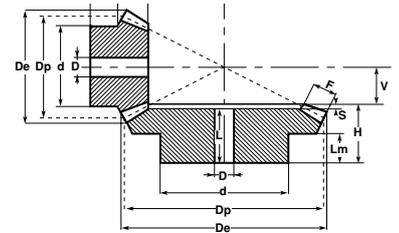

**Rapporto 1:2 / Ratio 1:2 / Untersetzung 1:2 / Rapport 1:2 / Relaciones 1:2**

M	Z	cod.	D <sub>e</sub>	D <sub>p</sub>	H	F	d	D	V	L	Lm	S
1	15	C26B300	17,4	15,0	11,9	5,0	13,3	4	10,1		6,5	
	30		30,6	30,0	15,1	5,0	20,3	5	4,9	13,7	9,0	1,4
1,5	15	C27B300	26,1	22,5	21,1	9,0	19,3	8	13,9		11,9	
	30		45,9	45,0	25,2	9,0	32,3	8	6,8	23,0	16,0	2,2
2	15	C28B300	34,8	30,0	26,0	11,5	25,3	8	19,0		14,1	
	30		61,2	60,0	29,8	11,5	40,3	14	9,2	26,8	18,0	3,0
2,5	15	C29B300	43,5	37,5	31,8	15,0	32,3	12	23,2		16,2	
	30		76,5	75,0	33,7	15,0	45,3	16	11,3	30,0	20,0	3,7
3	15	C30B300	52,2	45,0	37,3	17,0	40,3	12	28,7		19,9	
	30		91,8	90,0	42,1	17,0	55,3	16	13,9	38,0	25,0	4,1
3,5	15	C35B300	60,9	52,5	46,1	20,5	45,3	16	32,9		24,7	
	30		107,1	105,0	45,0	20,5	60,3	20	16,0	40,0	25,0	5,0
4	15	C31B300	69,6	60,0	48,6	22,5	50,3	20	38,4		24,6	
	30		122,3	120,0	57,3	22,5	80,3	25	18,7	51,9	35,0	5,4
4,5	15	C45B300	78,3	67,5	51,4	26,0	60,3	20	42,6		24,7	
	30		137,6	135,0	60,3	26,0	80,3	30	20,7	54,3	35,0	6,0
5	15	C32B300	87,0	75,0	57,6	30,0	60,3	25	46,4		25,3	
	30		152,9	150,0	62,5	30,0	80,3	30	22,5	56,0	35,0	6,5

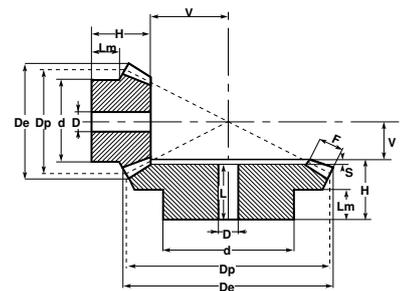

**Coppie coniche ad assi normali - tipo B - esecuzione speciale**  
**Bevel gear pairs with usual axes - type B - special execution**  
**Kegelräder mit Normalachsen - typ B - Spezialausführung**  
**Couples coniques avec essieux normaux - type B - exécution spéciale**  
**Engranajes conicos a ejes normales - tipo B - ejecución especial**

**Angolo di pressione 20°**  
**Materiale C 45 E**  
**UNI EN 10083-1**

**Pressure angle 20°**  
**Material C 45 E**  
**UNI EN 10083-1**

**Eingriffswinkel 20°**  
**Werkstoff C 45 E**  
**UNI EN 10083-1**

**Angle de pression 20°**  
**Matière C 45 E**  
**UNI EN 10083-1**

**Angulo de presion 20°**  
**Material C 45 E**  
**UNI EN 10083-1**

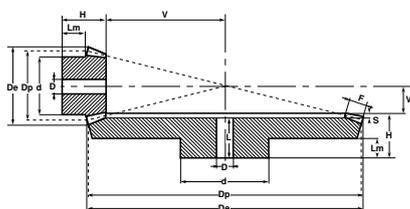

**Rapporto 1:2,5 / Ratio 1:2,5 / Untersetzung 1:2,5 / Rapport 1:2,5 / Relaciones 1:2,5**

M	Z	cod.	D <sub>e</sub>	D <sub>p</sub>	H	F	d	D	V	L	Lm	S
1	16	C26B400	18,6	16	14,4	6,5	13,3	4	13,6		7,4	
	40		40,4	40	14,8	6,5	25,3	8	5,2	13,0	9,0	1,8
1,5	16	C27B400	27,9	24	24,2	11,5	20,3	8	18,8		12,3	
	40		60,7	60	27,8	11,5	40,3	14	7,2	25,5	18,0	2,3
2	16	C28B400	37,2	32	29,6	15,0	25,3	8	25,4		13,7	
	40		80,9	80	32,4	15,0	45,3	16	9,6	29,0	20,0	3,4
2,5	16	C29B400	46,4	40	38,4	19,0	32,3	12	31,6		18,5	
	40		101,1	100	39,8	19,0	55,3	16	12,2	35,9	25,0	3,9
3	16	C30B400	55,7	48	41,9	21,5	40,3	16	39,1		19,6	
	40		121,4	120	47,9	21,5	60,3	20	15,1	44,0	30,0	3,9
3,5	16	C35B400	65,0	56	49,1	22,6	45,3	20	47,9		25,0	
	40		141,6	140	54,6	22,6	80,3	25	18,4	50,0	35,0	4,6
4	16	C31B400	74,3	64	52,5	26,0	55,3	20	54,5		25,3	
	40		161,8	160	57	26,0	80,3	30	21,0	50,5	35,0	6,5
4,5	16	C45B400	83,6	72	56,3	30,0	60,3	25	60,7		24,6	
	40		182,1	180	59,7	30,0	80,3	30	23,3	53,0	35,0	6,7
5	16	C32B400	92,9	80	65,4	32,0	60,3	25	68,6		30,1	
	40		202,3	200	65,7	32,0	90,3	30	26,3	58,3	40,0	7,4

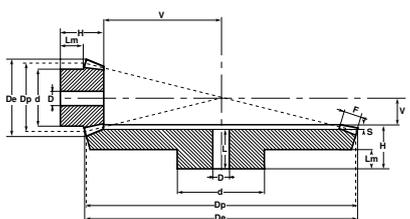

**Rapporto 1:3 / Ratio 1:3 / Untersetzung 1:3 / Rapport 1:3 / Relaciones 1:3**

M	Z	cod.	D <sub>e</sub>	D <sub>p</sub>	H	F	d	D	V	L	Lm	S
1	15	C26B450	17,7	15,0	16,6	7,1	13,3	4	15,4		9,2	
	45		45,3	45,0	17,1	7,1	25,3	8	4,9	15,2	10,0	1,9
1,5	15	C27B450	26,5	22,5	22,6	10,5	19,3	8	23,4		11,7	
	45		68,1	67,5	29,6	10,5	45,3	14	7,4	34,6	20,0	2,4
2	15	C28B450	35,4	30,0	28,9	14,0	25,3	8	31,1		14,2	
	45		90,8	90,0	32,1	14,0	45,3	16	9,9	28,4	20,0	3,7
2,5	15	C29B450	44,1	37,5	34,6	18,0	32,3	12	38,4		15,9	
	45		113,4	112,5	39,7	18,0	60,3	20	12,3	35,3	25,0	4,4
3	15	C30B450	53,0	45,0	41,3	21,0	40,3	16	46,7		19,7	
	45		136,1	135,0	47,2	21,0	60,3	25	14,8	42,0	30,0	5,2
3,5	15	C35B450	61,9	52,5	49,6	23,5	45,3	20	55,4		25,0	
	45		158,8	157,5	54,4	23,5	80,3	25	17,6	48,6	35,0	5,8
4	15	C31B450	70,7	60,0	54,3	27,5	50,3	20	62,7		25,4	
	45		181,5	180,0	57,0	27,5	80,3	30	20,0	50,5	35,0	6,5
4,5	15	C45B450	79,5	67,5	55,2	28,5	55,3	25	72,8		24,8	
	45		204,2	202,5	63,9	28,5	90,3	30	23,1	57,0	40,0	6,9
5	15	C32B450	88,4	75,0	65,3	33,0	60,3	25	79,7		30,0	
	45		226,9	225,0	66,7	33,0	90,3	30	25,3	59,2	40,0	7,5

**Coppie coniche ad assi normali - tipo B - esecuzione speciale**  
**Bevel gear pairs with usual axes - type B - special execution**  
**Kegelräder mit Normalachsen - typ B - Spezialausführung**  
**Couples coniques avec essieux normaux - type B - exécution spéciale**  
**Engranajes conicos a ejes normales - tipo B - ejecución especial**

**Angolo di pressione 20°**  
**Material C 45 E**  
**UNI EN 10083-1**

**Pressure angle 20°**  
**Material C 45 E**  
**UNI EN 10083-1**

**Eingriffswinkel 20°**  
**Werkstoff C 45 E**  
**UNI EN 10083-1**

**Angle de pression 20°**  
**Matière C 45 E**  
**UNI EN 10083-1**

**Angulo de presión 20°**  
**Material C 45 E**  
**UNI EN 10083-1**

**Rapporto 1:3,5 / Ratio 1:3,5 / Untersetzung 1:3,5 / Rapport 1:3,5 / Relaciones 1:3,5**

M	Z	cod.	D <sub>e</sub>	D <sub>p</sub>	H	F	d	D	V	L	Lm	S
1	16	C26B560	18,7	16	16,6	8,7	13,3	4	19,4		7,6	
	56		56,3	56	16,7	8,7	30,3	8	5,3	14,2	10,0	2,5
1,5	16	C27B560	28,1	24	24,0	12,0	20,3	8	30,0		11,5	
	56		84,5	84	34,8	12,0	45,3	14	8,2	32,0	25,0	2,8
2	16	C28B560	37,5	32	30,9	16,0	25,3	8	40,1		14,1	
	56		112,6	12	37,1	16,0	55,3	16	10,9	33,3	25,0	3,8
2,5	16	C29B560	46,8	40	38,9	20,0	32,3	14	50,1		17,9	
	56		140,8	140	44,4	20,0	60,3	20	13,6	40,0	30,0	4,4
3	16	C30B560	56,2	48	49,9	24,0	40,3	16	60,1		24,9	
	56		169,0	168	52,7	24,0	80,3	25	16,3	47,5	35,0	5,2
3,5	16	C35B560	65,6	56	52,0	25,0	25,5	20	73,0		25,5	
	56		197,1	196	55,1	25,0	80,3	25	19,9	49,1	35,0	6,0

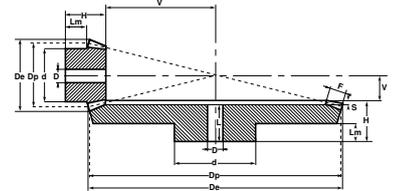

**Rapporto 1:4 / Ratio 1:4 / Untersetzung 1:4 / Rapport 1:4 / Relaciones 1:4**

M	Z	cod.	D <sub>e</sub>	D <sub>p</sub>	H	F	d	D	V	L	Lm	S
1	15	C26B600	17,80	15,0	17,2	9,3	13,3	4	20,8		7,7	
	60		60,30	60,0	17,1	9,3	30,3	8	4,9	15,2	10,0	1,9
1,5	15	C27B600	26,70	22,5	23,0	11,0	20,3	8	34,0		11,7	
	60		90,40	90,0	34,0	11,0	50,3	16	8,0	31,2	25,0	2,8
2	15	C28B600	35,60	30,0	31,0	16,0	25,3	8	44,0		14,4	
	60		120,60	120,0	37,6	16,0	60,3	16	10,4	24,2	25,0	3,4
2,5	15	C29B600	44,50	37,5	38,1	19,0	32,3	14	55,9		18,4	
	60		150,70	150,0	44,8	19,0	60,3	20	13,2	40,0	30,0	4,8
3	15	C30B600	53,30	45,0	48,1	23,0	40,3	16	66,9		24,5	
	60		180,80	180,0	53,2	23,0	80,3	25	15,8	48,2	35,0	5,0
3,5	15	C35B600	62,20	52,5	52,1	26,0	45,3	20	78,9		25,1	
	60		211,00	210,0	60,4	26,0	90,3	30	18,6	54,4	40,0	6,0
4	15	C31B600	71,10	60,0	55,1	30,0	50,3	20	89,9		23,0	
	60		241,10	240,0	60,8	30,0	90,3	30	21,2	53,0	40,0	7,8
4,5	15	C45B600	79,97	67,5	57,0	32,0	52,3	20	102,9		23,0	
	60		271,24	270,0	62,0	32,0	90,3	30	24,3	53,5	40,0	8,5
5	15	C32B600	88,80	75,0	62,0	34,0	55,3	20	115,7		25,0	
	60		301,30	300,0	65,0	34,0	90,3	30	27,0	55,0	40,0	10,0

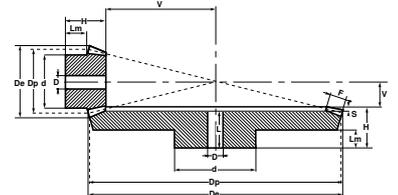

**Catene industriali**  
**Industrial chain**  
**Industriekette**  
**Chaîne industrielle**  
**Cadena industrial**

 **Standard Chain**

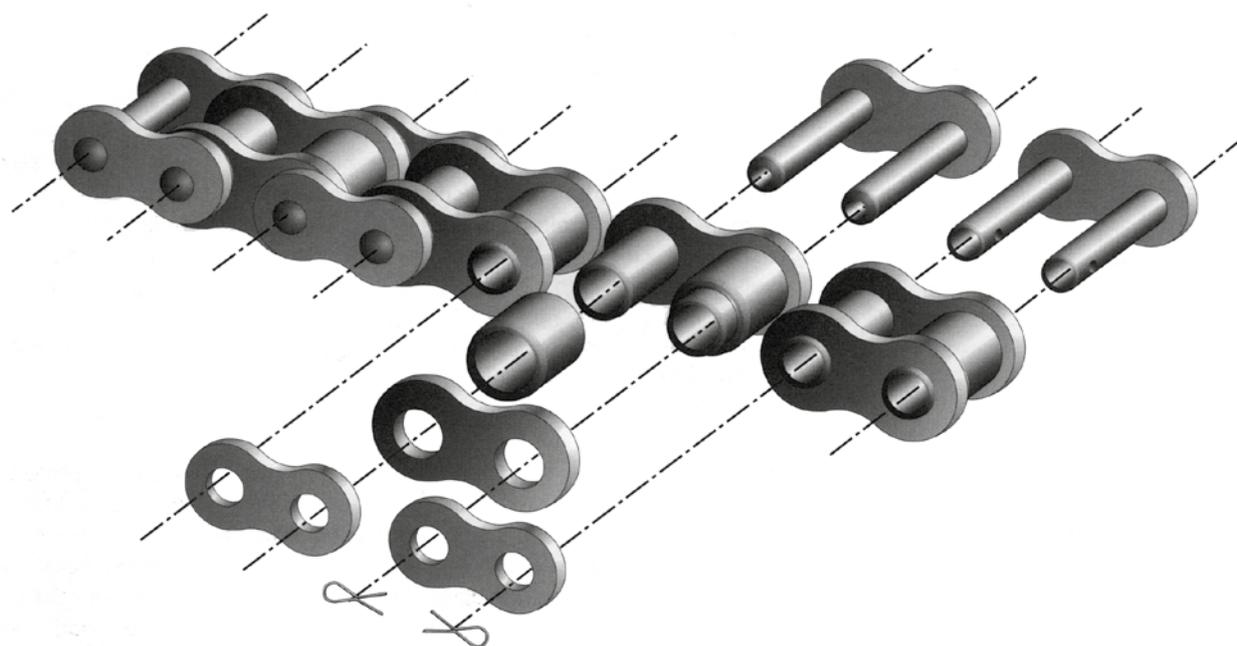

Prodotta da azienda certificata ISO 9001 / Manufactured by a company with certification ISO 9001  
Von einer Firma hergestellt, die ISO 9001 zertifiziert ist / Produite par une société certifié ISO 9001  
Producida por una empresa certificada UNI EN ISO 9001

Fig. 1

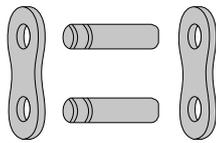

Fig. 2

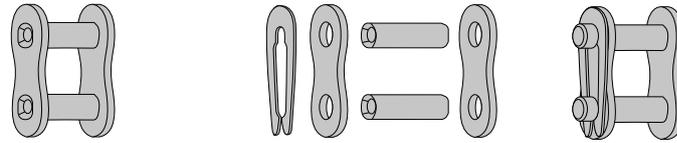

Fig. 3

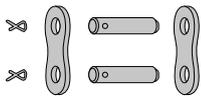

Fig. 4

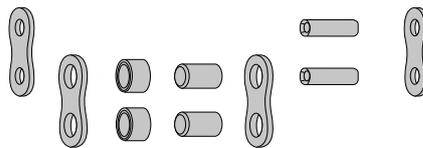
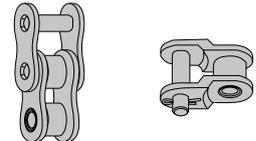

Fig. 5



**NOTE TECNICHE**

TUTTE LE NOSTRE CATENE  
**Standard Chain**  
 SONO PRESTIRATE

I principali componenti di una catena di trasmissione a rulli, sono:

- Piastre laterali sagomate di larghezza interna (**W**)
- Perni porta rulli avente diametro (**d**)
- Rulli, che si accoppiano con l'ingranaggio, aventi diametro (**D**)
- La distanza dei perni ne determina il passo (**p**).

Gli accessori pertinenti alla catena sono le **maglie di giunzione**, le **false maglie** (a due o tre rulli); per rendere solidali detti particolari con la catena, sono necessari le **mollette** oppure, in alternativa, le **coppiglie**.

La **fig. 1** indica il tipico passo (**p**) che compone la catena; successivamente, nella **fig. 2** è illustrato il **giunto** di collegamento con bloccaggio a **molletta**, mentre nella **fig. 3** è riportato il giunto con bloccaggio a **coppiglia**.

Nella **fig. 4** è riportato lo schema dell'alternanza, in fase di montaggio, delle piastre laterali, **interne ed esterne**.

Infine, dalla **fig. 5** si deduce la differenza della **maglia falsa a tre rulli** e quella **tradizionale**.

Le catene normalmente fornite, sono identificate dalla normativa di progetto che le hanno ideate: la standardizzazione **Europea** richiama l'unificazione **ISO/R 606-1982 (DIN 8187)** mentre quella **Americana** richiama l'unificazione **ANSI (DIN 8188)**; quest'ultima standardizzazione ha considerato caratteristiche

**TECHNICAL NOTES**

ALL OUR ROLLERCHAINS  
**Standard Chain**  
 ARE PRE-LOADED

The main components of a roller-type transmission chain are:

- Shaped side plates with internal width (**W**),
- Roller bearing pins with diameter (**d**),
- Rollers that couple with the gear wheel, with diameter (**D**),
- The distance of the pins determine their pitch (**p**).

The accessories belonging to the chain are connecting links, two or three roller-type offset links; to connect these parts to the chain, spring clips or alternatively cotter pins are required.

**Fig. 1** shows the typical pitch (**p**) the chain consists of; then in **figure 2** the connecting links with the clip-type lock are shown while **fig. 3** shows the cotter-type connecting links.

**Figure 4** shows external and internal side plate alternation during assembly.

Finally, the difference between the three-roller offset link and the traditional link can be seen in **fig. 5**.

The chains normally supplied are identified by the design standards used in their design; **European** standards refer to the **ISO/R 606-1982 (DIN 8187)** while **American** standards refer to **ANSI (DIN 8188)**; the latter standard has taken into consideration design characteristics that make them better able to withstand fatigue induced by breaking loads.

The chains are likely to

**TECHNISCHE ANGABEN**

ALLE UNSERE ROLLENKETTEN  
**Standard Chain**  
 SIND VORGERECKT

Die Hauptelemente einer Rollen-antriebskette sind:

- Seitliche Formplatten mit innerer Weite (**W**),
- Rollenaufnahmestifte mit Durchmesser (**d**),
- Rollen zur Kopplung an das Kettenrad, mit Durchmesser (**D**),
- Die Teilung (**p**) ist durch den Abstand der Stifte bedingt.

Die Zusatzteile der Kette sind die geraden, Verschussglieder die gekröpften Verschussglieder (für zwei oder drei Rollen). Um diese Teile mit der Kette zu verbinden sind Klammern oder Splinte erforderlich.

Die **Abb. 1** zeigt die typische Teilung (**p**) einer Kette. In der **Abb. 2** ist das gerade Verschussglied mit Klammer-spannung, und in **Abb. 3** die Kupplung mit Splintspannung dargestellt.

Die **Abb. 4** zeigt den Plan für das Abwechseln, während der Montage, von inneren und externen Seitenplatten.

Abschließend zeigt die **Abb. 5** den Unterschied zwischen gekröpften Verschussgliedern für drei Rollen und traditionellen gekröpften Verschussgliedern. Die normal gelieferten Ketten sind durch die Projekt-normen gekennzeichnet, nach denen sie entworfen wurden: der **europäische** Standard bezieht sich auf **ISO/R 606-1982 (DIN 8187)**, während der **amerikanische** Standard sich auf **ANSI-Normen (DIN 8188)** bezieht. Diese letzte Norm zieht Konstruktionseigenschaften in Betracht, dank

**REMARQUES TECHNIQUES**

TOUTES NOS CHAINES  
**Standard Chain**  
 SONT PRE-ETIREES

Une chaîne de transmission à rouleaux se compose essentiellement de:

- plaques latérales profilées de largeur interne (**W**),
- pivots porte rouleaux, diamètre (**d**),
- rouleaux qui s'accouplent à l'engrenage, diamètre (**D**),
- La distance entre les pivots détermine le pas (**p**).

Les accessoires indispensables à la chaîne sont les attaches rapides et les faux maillons (à deux ou trois rouleaux); pour que ces parties soient solidaires avec la chaîne, on utilise des pince (s) ou, en alternative, des goupilles.

La **fig. 1** illustre le pas typique (**p**) de la chaîne; la **fig. 2** illustre l'attache rapide avec blocage à pince (s) et la **fig. 3** montre l'attache rapide avec blocage à goupille.

La **fig. 4** montre le schéma du montage en alternance des plaques latérales internes et externes.

La **fig. 5** montre la différence du faux maillon à trois rouleaux par rapport à la maille traditionnelle.

Normalement, les chaînes portent l'identification de la norme de référence pour leur fabrication: l'harmonisation **européenne** se conforme à la norme **ISO/R 606-1982 (DIN 8187)** alors que l'harmonisation **américaine** se conforme à la norme **ANSI (DIN 8188)**; cette dernière inclut des caractéristiques de résistance à la charge sous effort plus importantes.

**NOTAS TÉCNICAS**

TODA NUESTRA CADENA  
**Standard Chain**  
 ESTA PREESTIRADA

Los principales componentes de una cadena de transmisión de rodillos, son:

- Placas laterales perfiladas con anchura interna (**W**),
- Pernos portarodillos con diámetro (**d**),
- Rodillos, que se acoplan con el engranaje, con diámetro (**D**),
- La distancia entre los pernos determina el paso (**p**).

Los accesorios de una cadena son los eslabones de unión y los falsos eslabones (de dos o tres rodillos); para unir dichas partes con la cadena se necesitan unas pinzas o, en alternativa, unos pasadores.

En la **fig. 1** se ilustra el típico paso (**p**) que compone la cadena. En la **fig. 2** se ilustra la junta de conexión con bloqueo mediante pinza y, en la **fig. 3**, en alternativa, con pasador.

En la **fig. 4** se ilustra el esquema de la alternancia, en fase de montaje, de las placas laterales, internas y externas.

Por último, en la **fig. 5**, se ilustra la diferencia entre el eslabón falso de tres rodillos y el tradicional.

Las cadenas suministradas normalmente están identificadas por la normativa de proyecto según la cual se han fabricado: la norma **Europea** remite a las normas **ISO/R 606-1982 (DIN 8187)** mientras que la norma **americana** remite a la norma **ANSI (DIN 8188)**; esta última norma tiene en cuenta unas características de proyecto por las cuales el producto resultante es mucho más



di progetto che le rende maggiormente resistenti al carico di rottura a fatica.

Le catene sono soggette al decadimento, delle caratteristiche originarie, per **usura o fatica**: nel primo caso si determina un'eccessiva usura del contatto tra perno e rullo che comporta un eccessivo allungamento del passo originario con conseguente possibilità di **salto dente**; la rottura a fatica avviene quando il valore reale di lavoro supera quello determinato in fase progettuale ed indicato nella tabella delle caratteristiche tecniche (N). Naturalmente, in questo caso, vincolante è il tipo di moto a cui vanno soggette le catene, ovvero, un carico continuo è meno oneroso di uno alternato a continui sovraccarichi (leggasi coppie di spunto iniziali, inerzie periodiche, ecc.).

Le forniture di catena vengono effettuate, normalmente, e nei passi più ricorrenti, in rotoli da **Mt. 5**; a richiesta del cliente possono essere fornite anche a spezzoni predeterminati. **Fare molta attenzione**, in questo caso, **alle note sottorportate**.

deteriorate from their original condition due to wear or fatigue: in the first case the wear of the contact point between pin and roller leads to an excessive lengthening of the original pitch with a consequent possibility of teeth being missed; breakage due to fatigue occurs when the real amount of work exceeds what was established at the design stage and shown on the table of technical characteristics (N). Naturally, in this case, the type of motion the chains are subjected to is binding, i.e. a continuous load is less of a burden than alternation with continuous overloads, (taken as initial take off loads, periodical inertia etc.).

Chains are usually supplied in the most commonly requested pitches, in **5m** rolls; if so requested by the customer they can also be supplied to pre-established lengths. In such a case, pay close attention to the notes below.

deren die Ketten eine höhere Reißfestigkeit aufweisen. Die Ketten unterliegen aufgrund von Verschleiß oder Belastung der Verschlechterung der Originaleigenschaften. Im ersten Fall tritt ein übermäßiger Verschleiß an der Kontaktstelle zwischen Stift und Rolle ein, was zur einer übermäßigen Verlängerung der ursprünglichen Teilung und zu einem möglichen Zahnüberspringen führt. Der Bruch der Kette tritt dann ein, wenn die tatsächliche Zugkraft (N) über der in der Tabelle der technischen Eigenschaften angegebenen Bruchkraft (N) liegt. Selbstverständlich ist dabei die Betriebsart der Ketten ausschlaggebend, d.h. der Dauerbetrieb ist weniger belastend als ein abwechselnder Betrieb mit übermäßigen Lasten (siehe dazu Anlaufmomente, periodische Trägheitsmomente usw.) Die Ketten werden normalerweise bei den gängigsten Teilungen in Rollen zu **5 m** geliefert. Auf Kundenwunsch können auch vorbestimmte Längen geliefert werden. Beachten Sie in diesem Fall die nachfolgenden Anmerkungen.

Les caractéristiques de base des chaînes ont tendance à décliner sous l'effet de l'usure et de l'effort: dans le premier cas, l'usure du contact entre pivot et rouleau fait augmenter excessivement le pas d'origine ce qui risque de faire sauter le dent; la chaîne peut se casser lorsqu'elle doit fournir un effort supérieur à celui prévu au moment de la fabrication (voir tableau des valeurs de charges N). Dans ce cas, le type de mouvement est déterminant c'est-à-dire que la chaîne supportera mieux une charge continue plutôt qu'un mouvement alternant surcharges et charges plus légères (en d'autres termes couples de démarrage, inerties périodiques, etc.).

Les chaînes sont généralement fournies avec les pas les plus utilisés, en rouleaux de **5 m**; sur demande, nous livrons également des tronçons à mesure prédéterminée. Dans ce cas, lisez attentivement les remarques ci-dessous.

resistente a la carga de rotura por fatiga.

Las cadenas están sujetas a la pérdida de las características originales, por desgaste o por fatiga: en el primer caso, se provoca un excesivo desgaste del contacto entre el perno y el rodillo que, a su vez, comporta un excesivo alargamiento del paso original con la consiguiente posibilidad de que salte un diente; la rotura por fatiga se produce cuando el valor real de trabajo supera el determinado en el proyecto e indicado en la tabla de las características técnicas (N). Naturalmente, en este caso, es determinante el tipo de movimiento al cual se someten las cadenas ya que una carga continua es menos fatigosa que una carga alterna con sobrecargas constantes (es decir, con pares de arranque iniciales, inercias periódicas, etc.) El suministro de cadenas se efectúa, normalmente, con los pasos más frecuentes, en rollos de **5 m**; a pedido, se pueden suministrar a trozos predeterminados. Prestar mucha atención, en dicho caso, a las siguientes notas.

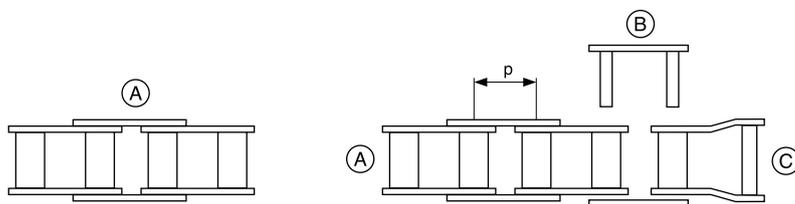

(A) = Spezzone catena / Chain length / Kettenlänge  
Tronçon de chaîne / Trozo de cadena

(B) = Giunto / Connecting link / Gerades Verschlussglied /  
Attache rapide / Junta

(C) = Falsa maglia / Offset link / Gekröpftes Verschlussglied /  
Faux maillon / Falso eslabón

## DETERMINAZIONE DEGLI SPEZZONI DI CATENA (A RICHIESTA)

**SPEZZONE:** Il numero dei passi (p) è sempre dispari

**GIUNTO:** Il giunto serve di collegamento e per chiudere ad anello lo spezzone di catena; in questo caso il numero dei passi (p) diventa pari. Inserendo anche la falsa maglia i passi (p) ritornano dispari

**FALSA:** Inserendola nello spezzone di catena originario, i passi (p) diventano pari, ma lo spezzone non si può chiudere ad anello

**N.B. - Se serve uno spezzone di catena a passi pari e chiusa ad anello (SENZA GIUNTO), occorre precisare: N° XXX passi, chiusa ad anello con «maglia ribadita»**

## ESTABLISHMENT OF CHAIN LENGTH (ON REQUEST)

**LENGTH -** The number of pitches is always odd.

**CONNECTING LINK -** The connecting link is used to connect and close the chain length into a ring: in this case, the number of pitches (p) becomes even. By inserting an offset link the number of pitches (p) becomes odd again.

**OFFSET LINK -** When it is inserted in the original length of chain, the number of pitches (p) becomes odd but the chain cannot close into a ring.

**N.B. If a chain length with an even number of pitches that closes into a ring is required, it is necessary to specify: No. XXX pitches, closed into a ring with "riveted link".**

## BESTIMMUNG DER KETTENLÄNGEN (AUF ANFRAGE)

**Kettenlänge:** Teilungszahlen (p) - muß immer ungerade sein.

**Gerades Verschlussglied -** das gerades Verschlussglied dient zum Zusammenfügen oder zum Ringschluß einer Kette. In diesem Fall muß die Teilungszahl (p) gerade sein. Beim Einfügen eines gekröpftes Verschlussgliedes wird die Teilungszahl (p) wieder ungerade.

**Gekröpftes Verschlussglied -** beim Einfügen in die ursprüngliche Kette wird die Teilungszahl gerade, wobei die Kette nicht als Ring zusammengefügt werden kann.

**Hinweis: Sollte eine Kette mit gerader Teilungszahl und Ringverschluß erforderlich sein (ohne Verschlussglied müssen folgende Angaben geliefert werden: xxx Teilungen, Ringverschluß mit "verstärktem Kettenglied".**

## CALCUL DES TRONÇONS DE CHAÎNE (SUR DEMANDE)

**TRONÇON -** le nombre de pas (p) est toujours impair.

**ATTACHE RAPIDE -** l'attache rapide permet de relier et de fermer le tronçon de chaîne par un anneau; dans ce cas, le nombre des pas (p) devient pair. En insérant le faux maillon, le nombre des pas (p) redevient impair.

**FAUX MAILLON -** en insérant le faux maillon dans le tronçon de chaîne d'origine, le nombre des pas (p) devient impair mais le tronçon ne peut pas être fermé avec un anneau.

**N.B.: En cas de nécessité d'un tronçon de chaîne à pas pairs et fermé avec un anneau, précisez: n° XXX pas, chaîne fermée par un anneau avec "maille rivée".**

## DETERMINACIÓN DE LOS TROZOS DE CADENA (A PEDIDO)

**TROZO -** el número de los pasos (p) siempre es impar

**JUNTA -** la junta sirve para unir y cerrar en anillo el trozo de cadena; en este caso, el número de los pasos (p) será par. Si se pone el falso eslabón, los pasos vuelven a ser impares.

**FALSO ESLABÓN -** si se introduce en el trozo de cadena original, los pasos (p) vuelven a ser impares, pero el trozo no se puede cerrar en anillo.

**N.B.: si se necesita un trozo de cadena con pasos pares y cierre con anillo, hay que precisar: N° XXX pasos, cierre de anillo con "eslabón remachado".**

**Nostro codice**

**Our code**

**Unser Kode**

**Notre code**

**Nuestro código**

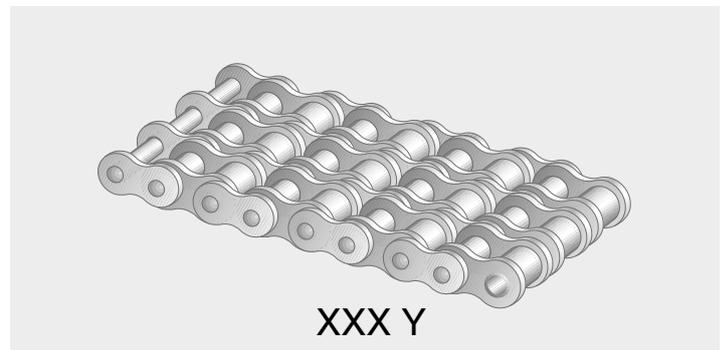
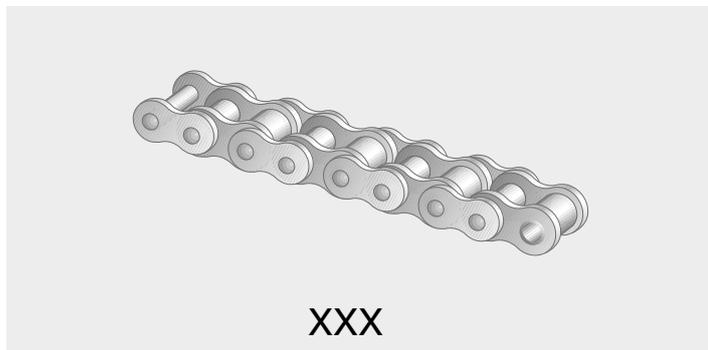
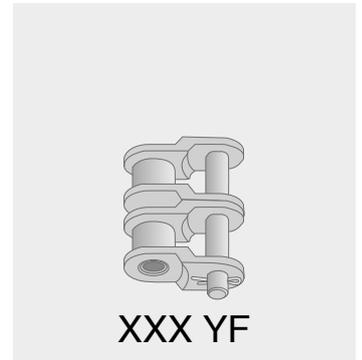
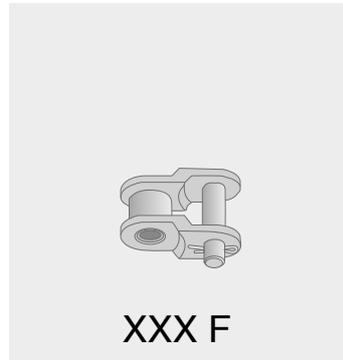
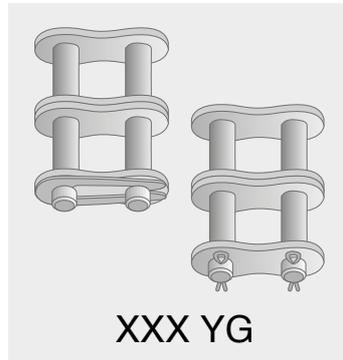

**Confezioni per particolare (n° pezzi)**

**Packages per type / Packung pro Einzelteil / Emballage des différents elements / Envases por pieza**

Tipo	Part.	Catena	Giunto S.	Giunto D.	Giunto T.	Falsa S.	Falsa D.	Falsa T.
	06B-12B		5 m	25	25	25	25	25
16B-32B		5 m	10	10	10	10	10	10

**ESEMPIO PER LA DETERMINAZIONE DI UNA TRASMISSIONE A CATENA**

**EXAMPLE FOR DETERMINATION OF A CHAIN TRANSMISSION**

**BEISPIEL FÜR DIE BESTIMMUNG EINES KETTENANTRIEBS**

**EXEMPLE POUR LA DÉFINITION D'UNE TRANSMISSION À CHAÎNE**

**EJEMPLO DE DETERMINACIÓN DE UNA TRANSMISIÓN DE CADENA**

PREMESSA:

INTRODUCTION:

VORAUSSETZUNG:

PRELIMINAIRES:

PREMISA:

**1) Determinazione del rapporto di trasmissione**

Il rapporto di trasmissione, ( $\tau$ ) si ottiene dal quoziente tra la ruota condotta Z2 e la ruota conduttrice Z1.  
 $\tau = Z2/Z1$

**1) Determining transmission ratio**

The transmission ratio ( $\tau$ ) is obtained from the quotient between the driven wheel Z2 and the driving wheel Z1.  
 $\tau = Z2/Z1$

**1) Bestimmung des Übersetzungsverhältnisses**

Das Übersetzungsverhältnis ( $\tau$ ) errechnet sich aus dem Quotienten zwischen dem getriebenen Rad (Z2) und dem antreibenden Rad (Z1).  $\tau = Z2/Z1$

**1) Définition du rapport de transmission**

Le rapport de transmission ( $\tau$ ) s'obtient à partir du quotient entre la roue menée Z2 et la roue menante Z1.  
 $\tau = Z2/Z1$

**1) Determinación de la relación de transmisión**

La relación de transmisión ( $\tau$ ) se obtiene mediante el cociente entre la rueda conducida Z2 y la rueda conductora Z1.  $\tau = Z2/Z1$

**2) Coefficienti di correzione**  
 Determinata la trasmissione, sarà utile parametrarla con i coefficienti C1 identificati tramite la tabella 1 (i dettagli alle tabelle 2-3-4).

**Coefficiente C1** è determinato dal tipo di carico a cui è soggetta la macchina, in funzione del lavoro che deve eseguire e dal tipo o quantità di inserimenti ciclici della parte conduttrice.

**2) Correction coefficients**  
 Once the transmission has been determined, it will be useful to make it a parameter with coefficients C1 and C2 identified by means of table 1 (details in tables 2 and 3).

**C1 coefficient:** This is determined by the type of load the machine is subjected to depending on the work that must be performed and the type and quantity of cyclical inputs by the driving wheel.

**2) Ausgleichkoeffizient**  
 Nach Festlegung des Übersetzungsverhältnisses sollte dieses mit den Koeffizienten C1 und C2 parametrisiert werden, die in Tabelle 1 aufgeführt sind (Details siehe Tabellen 2 und 3).

**Koeffizient C1:** Diese ist abhängig von der Belastung der Maschine je nach Art der auszuführenden Arbeit und Art oder Zahl der zyklischen Zuschaltungen der Antriebseinheit.

**2) Coefficient de correction**  
 Après avoir déterminé la transmission, paramétrez-la par rapport aux coefficients C1 et C2 que vous trouverez dans le tableau 1(détails aux tableaux 2-3).

**Coefficient C1:** Il est déterminé par le type de charge que doit supporter la machine en fonction du travail qu'elle doit effectuer et du type ou de la quantité d'actionnements cycliques de l'élément menant.

**2) Coeficientes de corrección**  
 Determinada la transmisión, es útil determinar los parámetros con los coeficientes C1 y C2 identificados mediante la tabla 1 (véanse los detalles en las tablas 2 y 3).

**Coefficiente C1:** Está determinado por el tipo de carga al cual está sujeto la máquina en función del trabajo que ha de efectuar y del tipo o cantidad de activaciones cíclicas de la parte conductora.

**Tab. 1**

	<b>Parte conduttrice / Driving part / Antriebseinheit / Element menant / Parte conductora</b>		
<b>Tipo di lavoro / Type of work Art des Arbeitsgangs Type de travail / Tipo de trabajo</b>	Ciclo dolce Gentle cycle Weicher Ablauf Cycle léger Ciclo débil	Ciclo alternato leggero Light alternate cycle Leichter Wechselablauf Cycle alterné léger Ciclo alterno ligero	Ciclo alternato medio Medium alternate cycle Mittlerer Wechselablauf Cycle alterné moyen Ciclo Alterno medio
<b>Carico costante / Constant load Konstante Belastung Charge constante / Carga constante</b>	1,0	1,1	1,3
<b>Carico discontinuo Discontinuous load / Ungleichmäßige Belastung / Charge discontinue Carga discontinua</b>	1,4	1,5	1,7
<b>Carico a strappi Jerking load / Stoßweise Belastung Charge à-coups / Carga a tirones</b>	1,8	1,9	2

**Tab. 2**

<b>Ciclo / Cycle / Zyklus / Cycle / Ciclo</b>	<b>Parte conduttrice / Driving part / Antriebseinheit / Element menant / Parte conductora</b>
<b>Dolce Gentle / Weich Léger / Débil</b>	Motore elettrico - motore endotermico - motore idraulico / Electric motor - endothermic motor - hydraulic motor Elektrischer Motor - endothermischer Motor, hydraulischer Motor / Moteur électrique - Moteur thermique - Moteur hydraulique / Motor eléctrico - motor endotérmico - motor hidráulico
<b>Alternato leggero Light alternate / Leichter Wechsel Alterné léger / Alterno ligero</b>	Motore a combustione interna ed accoppiamento meccanico / Internal combustion motor and mechanical coupling Verbrennungsmotor und mechanische Kopplung / Moteur à combustion interne et accouplement mécanique Motores de combustión interna y acoplamiento mecánico
<b>Alternato medio Medium alternate / Mittlerer Wechsel Alterné moyen / Alterno medio</b>	Motori a combustione interna con pochi cilindri ed accoppiamento meccanico Internal combustion motor with few cylinders and mechanical coupling Verbrennungsmotor mit wenigen Zylindern und mechanische Kopplung Moteur à combustion interne avec peu de cylindres et accouplement mécanique Motores de combustión interna con pocos cilindros y acoplamiento mecánico

**Tab. 3**

<b>Tipo di lavoro Type of work / Art des Arbeitsgangs Type de travail / Tipo de trabajo</b>	<b>Tipo di macchina condotta / Driven part / Art der angetriebenen Maschine Type de machine mène / Tipo de máquina conducida</b>
<b>Carico costante / Constant load Konstante Belastung Charge constante / Carga constante</b>	Pompe centrifughe - Trasportatori ad alimentazione costante - Calandre - Ventilatori - Essiccatoi - Agitatori di materiali a bassa densità / Centrifuge pumps - Constant feed transporters - Calenders - Fans - Dryers - Low-density material mixers / Zentrifugalpumpen - Stetigförderer - Kalander - Lüfter - Trockner - Rührwerke für dünnflüssige Materialien / Pompes centrifuges / Transporteurs à alimentation constante - Calandres - Ventilateurs - Dessiccateurs - Agitateurs de matériaux basse densité / Bombas centrífugas - transportadores con alimentación constante - calandrias - ventiladores - secadores - agitadores de materiales de baja densidad
<b>Carico discontinuo Discontinuous load / Ungleichmäßige Belastung / Charge discontinue Carga discontinua</b>	Compressori - Macchine per mescole - Trasportatori ad alimentazione non uniforme - Agitatori e miscelatori di solidi o ad alta densità / Compressors - Mixing machines - Non-uniform feed transporters - Stirrers and mixers of solid or high-density materials / Kompressoren Mischmaschinen - Unstetigförderer - Rühr- und Mischwerke für Feststoffe oder dickflüssige Stoffe / Compresseurs - Malaxeurs - Transporteurs à alimentation non uniforme - Agitateurs et mélangeurs de matériaux solides ou haute densité / Compresores - máquinas para mezclas - transportadores con alimentación no uniforme - agitadores y mezcladores de sólidos o materiales de alta densidad
<b>Carico a strappi Jerking load / Stoßweise Belastung Charge à-coups / Carga a tirones</b>	Molini - Macchine lavorazione gomma - Presse - Punzonatrici - Macchine lavorazione terra - Compressori monocilindrici / Mills - Rubber processing machines - Presses - Punches - Earth processing machines - Monocylindrical compressors / Mahlwerke - Gummiverrbeitungsmaschinen - Pressen - Stempelmaschinen - Erdbewegungsmaschinen - Einzylinderkompressoren / Moulins - Machines pour usinage du caoutchouc - Presses - Poinçonneuses - Machines de terrassement - Compresseurs monocylindre / Molinos - máquina elaboración de gomas - prensas - punzonadoras - máquinas movimiento tierra - compresores monocilindros

Tab. 4

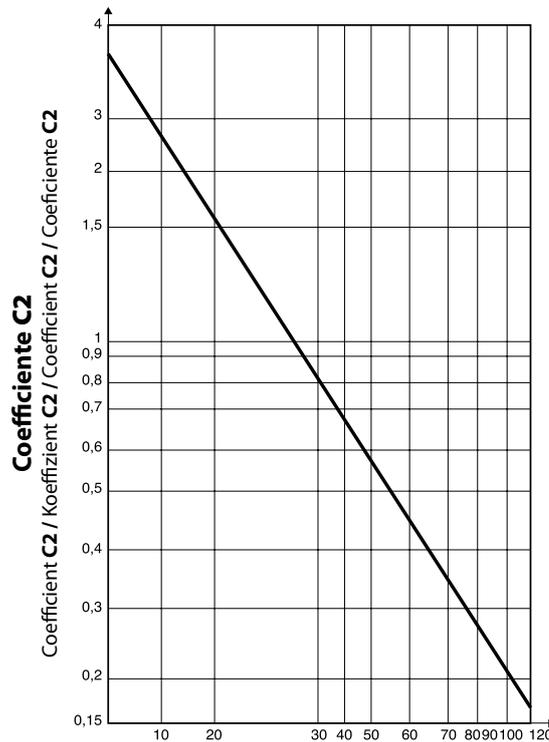

**N° denti pignone conduttore**  
 Driving Sprocket's teeth number / Zähnezahl des Antriebsritzels  
 Nbre Dents du pignon menant / N° dientes de piñon conductor

**Criteri di progettazione di una trasmissione a catena**

**Design criteria for a transmission chain**

**Konstruktionskriterien eines Kettenantriebs**

**Criteres de conception d'une transmission a chaîne**

**Criterios de los proyectos de una transmisión de cadena**

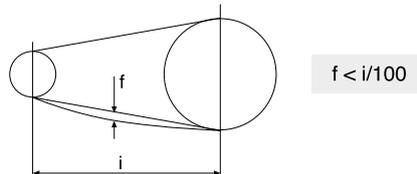

1) L'interasse tra ruota condotta e conduttrice, deve permettere alla catena di avvolgere la ruota conduttrice, almeno per un arco di cerchio di 120°.

2) Una tensione appropriata della catena è alla base di una buona trasmissione; a tal scopo occorre provvedere con galoppini dentati o altri mezzi normalmente in commercio (ciò quando non è possibile provvedere alla regolazione dell'interasse).

La pratica porta a considerare che la freccia di flessione non debba essere superiore all'1% della dimensione dell'interasse (la quota f è da rilevarsi a metà di quest'ultimo).

3) Una buona lubrificazione, oltre a determinare il corretto ottenimento delle prestazioni fisiche, determina un valido deterrente alla normale usura della catena.

1) The centre-to-centre distance between the driving and driven wheels must allow the chain to wind around the driving wheel for a circle arc of at least of 120°.

2) Appropriate chain tension underlies good transmission; to this end it is necessary to use idler sprockets or other means normally found on the market (this is when it is not possible to regulate the centre-to-centre distance).

3) As well as ensuring proper performance, correct lubrication prevents chain wear.

1) Der Achsabstand zwischen angetriebenem und antreibendem Rad muß der Kette genügend Raum belassen, damit diese das Antriebsrad mindestens im Winkel von 120° umschließen kann.

2) Eine gute Antriebsleistung hängt vorwiegend von einer geeigneten Kettenspannung ab. Dazu sind Kettenspannräder oder sonstige handelsübliche Elemente einzusetzen (falls eine Verstellung des Achsabstands nicht möglich ist) Die Praxis zeigt, daß der Durchhang der Kette nicht über 1% des Achsabstands liegen sollte (das Maß f ist in der Mitte zu messen).

3) Eine gute Schmierung trägt nicht nur zur Erzielung der gewünschten Leistungen bei, sondern verzögert auch den normalen Verschleiß der Kette.

1) L'entraxe entre roue menée et roue menante doit permettre à la chaîne d'entourer la roue menante au moins sur un arc de cercle de 120°.

2) Pour obtenir une bonne transmission, la chaîne doit être tendue correctement; pour ce faire, utilisez des pignons tendeurs ou tout autre moyen disponible dans le commerce (lorsqu'il s'avère impossible de régler l'entraxe). Dans la pratique, on considère que la flèche de flexion ne dépasse pas de plus d'1% la dimension de l'entraxe (la cote f doit être mesurée au milieu de l'entraxe).

3) Lubrifiez correctement la chaîne pour en obtenir un rendement optimal mais aussi pour éviter qu'elle ne s'use rapidement.

1) La distancia entre la rueda conducida y la conductora ha de permitir que la cadena enrolle la rueda conductora, al menos, por un arco de círculo de 120°.

2) Una tensión apropiada de la cadena es la base para una buena transmisión; para ello, hay que utilizar poleas directrices dentadas u otros medios normalmente en comercio (esto cuando no sea posible regular la distancia). Fruto de la experiencia se considera que la flecha de flexión no tiene que ser superior al 1% de la dimensión de la distancia (la cota f se tiene que medir en la mitad de éste último).

3) Una buena lubricación, además de determinar las correctas prestaciones físicas, atenúa el desgaste normal de la cadena.

Parametri da tener presente sono i seguenti: Parameters to be remembered are the following: Dabei sind folgende Parameter zu berücksichtigen: Paramètres de référence: Parámetros que hay que tener en consideración:

	Parte conduttrice / Driving part / Antriebseinheit / Element menant / Parte conductora	
<b>Ambiente freddo / Cold environment</b> <b>Kalte Umgebung / Climat froid</b> <b>Ambiente frío</b>	-5°C	20 SAE
<b>Ambiente normale / Normal environment</b> <b>Normale Umgebung / Climat normal</b> <b>Ambiente normal</b>	+5 ÷ +25°C	30 SAE
<b>Ambiente caldo / Warm environment</b> <b>Warme Umgebung / Climat chaud</b> <b>Ambiente caluroso</b>	+25 ÷ +45°C	40 SAE
<b>Ambiente torrido / Hot environment</b> <b>Heiße Umgebung / Climat torride</b> <b>Ambiente muy caluroso</b>	+45 ÷ +70°C	50 SAE
<b>Altissime temperature / Very high temperatures</b> <b>Hochtemperaturen / Températures très élevées</b> <b>Temperaturas muy altas</b>	Consultare specifiche per grassi adatti a forni Consult the specifications of greases suitable for ovens/furnaces Siehe Spezifikationen der für Öfen geeigneten Fette Consulter les caractéristiques pour les graisses allant au four Consultar indicaciones para grasas adecuadas a los altos hornos	

La velocità e le dimensioni della catena, sono determinanti per il tipo di lubrificazione. The speed and dimensions of the chain are what dictate the type of lubrication. Für die Schmierung sind die Geschwindigkeit und die Größe der Kette ausschlaggebend. La vitesse et les dimensions de la chaîne sont déterminantes pour le type de lubrification. La velocidad y las dimensiones de la cadena son determinantes para el tipo de lubricación.

Esempio catena Chain example / Beispiel Kette Exemple chaîne / Ejemplo cadena	Velocità fino Speed up to / Geschwindigkeit bis Vitesse jusqu'à / Velocidad hasta	Sistema System / System Système / Sistema
3/8"	1Mt/sec	manuale / manual / Handgemacht / manuel / manual
1"	1Mt/sec	a goccia / drop type / tropfenweise / goutte à goutte / goteo
3/8"	2Mt/sec	a goccia / drop type / tropfenweise / goutte à goutte / goteo
1"	2Mt/sec	a bagno d'olio / oil bath / Ölbad / à bain d'huile / baño de aceite
3/8"	10Mt/sec	lubrificazione forzata / forced lubrication / Drucksmiering lubrification forcée / lubricación forzada
1"	6Mt/sec	lubrificazione forzata / forced lubrication / Drucksmiering lubrification forcée / lubricación forzada

4) Determinazione della lunghezza della catena (teorico): 4) Determination of the chain length (theoretical): 4) Bestimmung der Kettenlänge (theoretisch): 4) Détermination de la longueur de la chaîne (théorique): 4) Determinación de la longitud de la cadena (teórica):

$$S_v = 2 \frac{l}{p} + \left( \frac{Z_1 + Z_2}{2} \right) + \left[ \left( \frac{Z_2 - Z_1}{2\pi} \right)^2 \times \frac{p}{l} \right]$$

Sv = lunghezza catena l = Interasse Z1 = denti ruota conduttrice Z2 = denti ruota condotta p = passo	Sv = chain length l = centre-to-centre distance Z1 = Driving wheel teeth Z2 = Driven wheel teeth p = pitch	Sv = Kettenlänge l = Achsabstand Z1 = Zähne des Antriebsrads Z2 = Zähne des angetriebenen Rads p = Teilung	Sv = longueur chaîne l = entraxe Z1 = dents de la roue menante Z2 = dents de la roue menée p = pas	Sv = longitud cadena l = distancia entre ejes Z1 = dientes de la rueda conductora Z2 = dientes de la rueda conducida p = paso
--	--	--	--	---

**Catena a rulli - serie europea ISO/R 606 DIN 8187 / Roller chain - European series ISO/R 606 DIN 8187**  
**Rollenkette - europäische Serie ISO/R 606 DIN 8187 / Chaîne a rouleaux - série européenne ISO/R 606 DIN 8187**  
**Cadena de rodillos - serie europea ISO/R 606 DIN 8187**

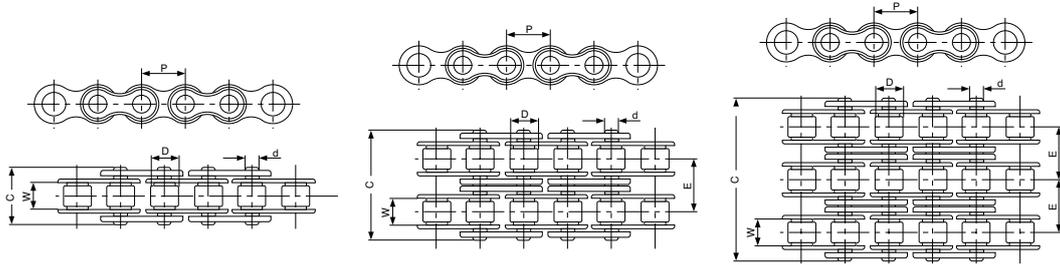

Catena semplice		Simplex chain		Einfach Kette		Chaîne simple		Cadena simple		
Nostro codice Our code Unser Kode Notre code Nuestro código	Codice ISO ISO code ISO Kode Code ISO Código ISO	Designazione Designation Benennung Désignation Denominación	Dimensioni / Dimentions Abmessungen / Dimensions Dimensiones					Peso al metro Weight per metre Gewicht pro Meter Poids par mètre Peso por metro Kg/m	Carico di rottura minimo Minimum breaking load Mindestbruchkraft Charge de rupture minimale Carga de rotura minima N	Carico di rottura medio Average breaking load Durchschnittliche Bruchkraft Charge de rupture moyenne Carga de rotura media N
			P mm	W mm	D mm	d mm	C mm			
04B1	04 B1	6 x 2,8 mm	6,000	2,80	4,00	1,85	7,60	0,11	3000	3200
05B1	05 B1	8 x 3 mm	8,000	3,00	5,00	2,31	7,90	0,20	5000	5900
06B1	06 B1	3/8" x 7/32"	9,525	5,72	6,35	3,28	13,15	0,41	9000	10400
081B1	081 - 1	1/2" x 1/8"	12,700	3,30	7,75	3,65	9,30	0,30	8036	8200
083B1	083 - 1	1/2" x 3/16"	12,700	4,88	7,75	3,96	11,95	0,69	11600	13200
08B1	08 B1	1/2" x 5/16"	12,700	7,75	8,51	4,45	16,70	0,69	18000	19400
10B1	10 B1	5/8"	15,875	9,65	10,16	5,08	19,50	0,93	22400	27500
12B1	12 B1	3/4"	19,050	11,68	12,07	5,72	22,50	1,15	29000	32200
16B1	16 B1	1"	25,400	17,02	15,88	8,28	36,10	2,71	60000	72800
20B1	20 B1	1" 1/4	31,750	19,56	19,05	10,19	41,30	3,70	95000	106700
24B1	24 B1	1" 1/2	38,100	25,40	25,40	14,63	53,40	7,10	160000	178000
28B1	28 B1	1" 3/4	44,450	30,99	27,94	15,90	65,10	8,50	200000	222000
32B1	32 B1	2"	50,800	30,99	29,21	17,81	66,00	10,25	250000	277500

Catena doppia		Duplex chain		Zweifach Kette		Chaîne double		Cadena doble			
Nostro codice Our code Unser Kode Notre code Nuestro código	Codice ISO ISO code ISO Kode Code ISO Código ISO	Designazione Designation Benennung Désignation Denominación	Dimensioni / Dimentions Abmessungen / Dimensions Dimensiones						Peso al metro Weight per metre Gewicht pro Meter Poids par mètre Peso por metro Kg/m	Carico di rottura minimo Minimum breaking load Mindestbruchkraft Charge de rupture minimale Carga de rotura minima N	Carico di rottura medio Average breaking load Durchschnittliche Bruchkraft Charge de rupture moyenne Carga de rotura media N
			P mm	W mm	D mm	d mm	E mm	C mm			
05B2	05 B2	8 x 3 mm	8,000	3,00	5,00	2,31	5,64	19,75	0,33	7800	10200
06B2	06 B2	3/8" x 7/32"	9,525	5,72	6,35	3,28	10,24	23,40	0,77	16900	18700
08B2	08 B2	1/2" x 5/16"	12,700	7,75	8,51	4,45	13,92	31,20	1,34	32000	38700
10B2	10 B2	5/8"	15,875	9,65	10,16	5,08	16,59	36,10	1,84	44500	56200
12B2	12 B2	3/4"	19,050	11,68	12,07	5,72	19,46	42,00	2,31	57800	66100
16B2	16 B2	1"	25,400	17,02	15,88	8,28	31,88	68,00	5,42	106000	133000
20B2	20 B2	1" 1/4	31,750	19,56	19,05	10,19	36,45	77,80	7,20	170000	211200
24B2	24 B2	1" 1/2	38,100	25,40	25,40	14,63	48,36	101,70	13,40	280000	319200
28B2	28 B2	1" 3/4	44,450	30,99	27,94	15,90	59,56	124,60	16,60	360000	406800
32B2	32 B2	2"	50,800	30,99	29,21	17,81	58,55	124,60	21,00	450000	508500

Catena tripla		Triplex chain		Dreifach Kette		Chaîne triple		Cadena tripla			
Nostro codice Our code Unser Kode Notre code Nuestro código	Codice ISO ISO code ISO Kode Code ISO Código ISO	Designazione Designation Benennung Désignation Denominación	Dimensioni / Dimentions Abmessungen / Dimensions Dimensiones						Peso al metro Weight per metre Gewicht pro Meter Poids par mètre Peso por metro Kg/m	Carico di rottura minimo Minimum breaking load Mindestbruchkraft Charge de rupture minimale Carga de rotura minima N	Carico di rottura medio Average breaking load Durchschnittliche Bruchkraft Charge de rupture moyenne Carga de rotura media N
			P mm	W mm	D mm	d mm	E mm	C mm			
05B3	05 B3	8 x 3 mm	8,000	3,00	5,00	2,31	5,64	19,40	0,48	11100	13800
06B3	06 B3	3/8" x 7/32"	9,525	5,72	6,35	3,28	10,24	33,50	1,16	24900	30100
08B3	08 B3	1/2" x 5/16"	12,700	7,75	8,51	4,45	13,92	45,10	2,03	47500	57800
10B3	10 B3	5/8"	15,875	9,65	10,16	5,08	16,59	52,70	2,77	66700	84500
12B3	12 B3	3/4"	19,050	11,68	12,07	5,72	19,46	61,50	3,46	86700	101800
16B3	16 B3	1"	25,400	17,02	15,88	8,28	31,88	99,80	8,13	160000	203700
20B3	20 B3	1" 1/4	31,750	19,56	19,05	10,19	36,45	114,20	10,82	250000	290000
24B3	24 B3	1" 1/2	38,100	25,40	25,40	14,63	48,36	150,10	20,10	425000	493000
28B3	28 B3	1" 3/4	44,450	30,99	27,94	15,90	59,56	184,20	24,92	530000	609500
32B3	32 B3	2"	50,800	30,99	29,21	17,81	58,55	183,10	31,56	670000	770500

**Catena a rulli - serie americana ASA ANSI B 29,1 ISO/R 606 DIN8188**  
**Roller chain - American series ASA ANSI B 29,1 ISO/R 606 DIN8188**  
**Rollenkette - amerikanische Serie ASA ANSI B 29,1 ISO/R 606 DIN8188**  
**Chaîne a rouleaux - série américaine ASA ANSI B 29,1 ISO/R 606 DIN8188**  
**Cadena de rodillos - serie americana ASA ANSI B 29,1 ISO/R 606 DIN8188**

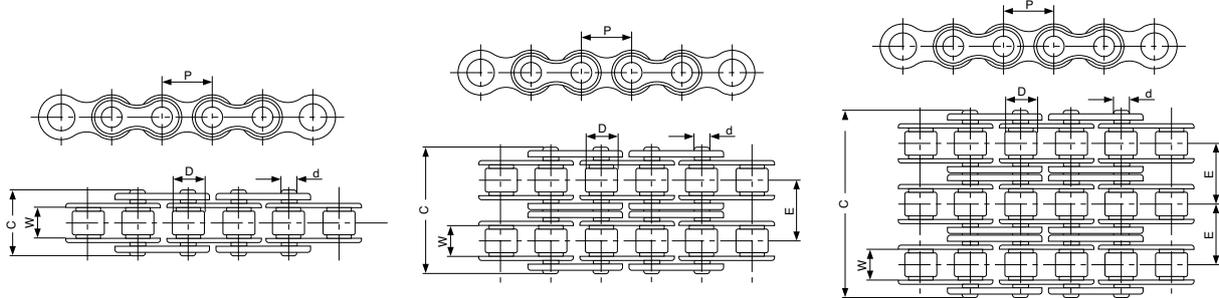

Catena semplice		Simplex chain		Einfach Kette		Chaîne simple		Cadena simple		
Nostro codice Our code Unser Kode Notre code Nuestro código	Codice ASA "ANSI" ASA "ANSI" code ASA "ANSI" Kode Code ASA "ANSI" Código ASA "ANSI"	Designazione Designation Benennung Désignation Denominación	Dimensioni / Dimentions Abmessungen / Dimensions Dimensiones					Peso al metro Weight per metre Gewicht pro Meter Poids par mètre Peso por metro Kg/m	Carico di rottura minimo Minimum breaking load Mindestbruchkraft Charge de rupture minimale Carga de rotura minima N	Carico di rottura medio Average breaking load Durchschnittliche Bruchkraft Charge de rupture moyenne Carga de rotura media N
			P mm	W mm	D mm	d mm	C mm			
25A1	25	1/4"	6,350	3,18	3,30	2,31	7,90	0,15	3500	4600
06A1	35	3/8"	9,525	4,77	5,08	3,58	12,30	0,33	7900	10800
08A1	40	1/2"	12,700	7,85	7,94	3,96	16,60	0,62	14100	17500
10A1	50	5/8"	15,875	9,40	10,16	5,08	20,70	1,02	22200	29400
12A1	60	3/4"	19,050	12,57	11,91	5,94	25,90	1,50	31800	41500
16A1	80	1"	25,400	15,75	15,88	7,92	32,70	2,60	56700	69400
20A1	100	1 1/4"	31,750	18,90	19,05	9,53	40,40	3,91	88500	109200
24A1	120	1 1/2"	38,100	25,22	22,22	11,10	50,30	5,62	127000	156300
28A1	140	1 3/4"	44,450	25,22	25,40	12,70	54,40	7,50	172400	212000
32A1	160	2"	50,800	31,55	28,58	14,27	64,80	10,10	226800	278900

Catena doppia		Duplex chain		Zweifach Kette		Chaîne double		Cadena doble			
Nostro codice Our code Unser Kode Notre code Nuestro código	Codice ASA "ANSI" ASA "ANSI" code ASA "ANSI" Kode Code ASA "ANSI" Código ASA "ANSI"	Designazione Designation Benennung Désignation Denominación	Dimensioni / Dimentions Abmessungen / Dimensions Dimensiones						Peso al metro Weight per metre Gewicht pro Meter Poids par mètre Peso por metro Kg/m	Carico di rottura minimo Minimum breaking load Mindestbruchkraft Charge de rupture minimale Carga de rotura minima N	Carico di rottura medio Average breaking load Durchschnittliche Bruchkraft Charge de rupture moyenne Carga de rotura media N
			P mm	W mm	D mm	d mm	E mm	C mm			
06A2	35-2	3/8"	9,525	4,77	5,08	3,58	10,13	22,20	0,63	15800	19700
08A2	40-2	1/2"	12,700	7,85	7,94	3,96	14,38	31,00	1,12	28200	35900
10A2	50-2	5/8"	15,875	9,40	10,16	5,08	18,11	38,80	2,00	44400	58100
12A2	60-2	3/4"	19,050	12,57	11,91	5,94	22,78	48,80	2,92	63600	82100
16A2	80-2	1"	25,400	15,75	15,88	7,92	29,29	62,00	5,15	113400	141800
20A2	100-2	1 1/4"	31,750	18,90	19,05	9,53	35,76	76,40	7,80	177000	219400
24A2	120-2	1 1/2"	38,100	25,22	22,22	11,10	45,44	95,80	11,70	254000	314900
28A2	140-2	1 3/4"	44,450	25,22	25,40	12,70	48,87	103,30	15,14	344800	427500
32A2	160-2	2"	50,800	31,55	28,58	14,27	58,55	123,30	20,14	453600	562400

Catena tripla		Triplex chain		Dreifach Kette		Chaîne triple		Cadena tripla			
Nostro codice Our code Unser Kode Notre code Nuestro código	Codice ASA "ANSI" ASA "ANSI" code ASA "ANSI" Kode Code ASA "ANSI" Código ASA "ANSI"	Designazione Designation Benennung Désignation Denominación	Dimensioni / Dimentions Abmessungen / Dimensions Dimensiones						Peso al metro Weight per metre Gewicht pro Meter Poids par mètre Peso por metro Kg/m	Carico di rottura minimo Minimum breaking load Mindestbruchkraft Charge de rupture minimale Carga de rotura minima N	Carico di rottura medio Average breaking load Durchschnittliche Bruchkraft Charge de rupture moyenne Carga de rotura media N
			P mm	W mm	D mm	d mm	E mm	C mm			
06A3	35-3	3/8"	9,525	4,77	5,08	3,58	10,13	32,80	1,05	23700	28600
08A3	40-3	1/2"	12,700	7,85	7,94	3,96	14,38	45,40	1,90	42300	50000
10A3	50-3	5/8"	15,875	9,40	10,16	5,08	18,11	56,90	3,09	66600	77800
12A3	60-3	3/4"	19,050	12,57	11,91	5,94	22,78	71,60	4,54	95400	111100
16A3	80-3	1"	25,400	15,75	15,88	7,92	29,29	91,30	7,89	170100	198400
20A3	100-3	1 1/4"	31,750	18,90	19,05	9,53	35,76	112,20	11,77	265500	309600
24A3	120-3	1 1/2"	38,100	25,22	22,22	11,10	45,44	141,10	17,53	381000	437200
28A3	140-3	1 3/4"	44,450	25,22	25,40	12,70	48,87	152,20	22,20	517200	593300
32A3	160-3	2"	50,800	31,55	28,58	14,27	58,55	181,80	30,02	680400	780600

**Catena a rulli nichelata - serie europea ISO/R 606 DIN 8187 / Nickel plated roller chain - European series ISO/R 606 DIN 8187 / Vernickelte Rollenkette - europäische Serie ISO/R 606 DIN 8187 / Chaîne a rouleaux nickelée - série européenne ISO/R 606 DIN 8187 / Cadena de rodillos niquelada - serie europea ISO/R 606 DIN 8187**

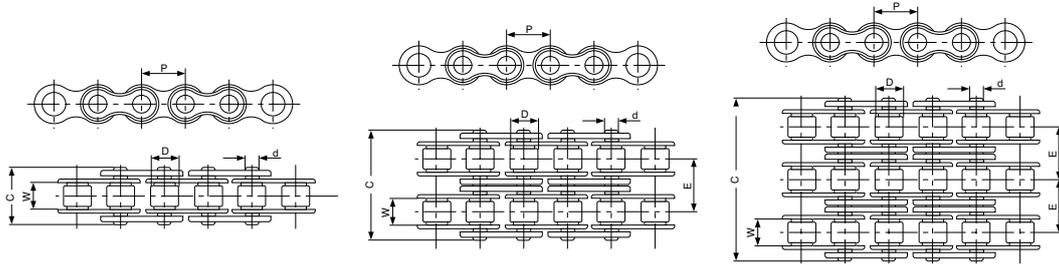

<b>Catena semplice</b>		<b>Simplex chain</b>		<b>Einfach Kette</b>		<b>Chaîne simple</b>		<b>Cadena simple</b>	
Nostro codice Our code Unser Kode Notre code Nuestro código	Designazione Designation Benennung Désignation Denominación	Dimensioni / Dimentions Abmessungen / Dimensions Dimensiones					Peso al metro Weight per metre Gewicht pro Meter Poids par mètre Peso por metro Kg/m	Carico di rottura minimo Minimum breaking load Mindestbruchkraft Charge de rupture minimale Carga de rotura minima N	Carico di rottura medio Average breaking load Durchschnittliche Bruchkraft Charge de rupture moyenne Carga de rotura media N
		P mm	W mm	D mm	d mm	C mm			
04N1	6 x 2,8 mm	6,000	2,80	4,00	1,85	7,60	0,11	3000	3200
05N1	8 x 3 mm	8,000	3,00	5,00	2,31	7,90	0,20	5000	5900
06N1	3/8" x 7/32"	9,525	5,72	6,35	3,28	13,15	0,41	9000	10400
08N1	1/2" x 5/16"	12,700	7,75	8,51	4,45	16,70	0,69	18000	19400
10N1	5/8"	15,8750	9,65	10,16	5,08	19,50	0,93	22400	27500
12N1	3/4"	19,050	11,68	12,07	5,72	22,50	1,15	29000	32200
16N1	1"	25,400	17,02	15,88	8,28	36,10	2,71	60000	72800
20N1	1" 1/4	31,750	19,56	19,05	10,19	41,30	3,70	95000	106700
24N1	1" 1/2	38,100	25,40	25,40	14,63	53,40	7,10	160000	178000
28N1	1" 3/4	44,450	30,99	27,94	15,90	65,10	8,50	200000	222000
32N1	2"	50,800	30,99	29,21	29,21	17,81	66,00	250000	277500

<b>Catena doppia</b>		<b>Duplex chain</b>		<b>Zweifach Kette</b>		<b>Chaîne double</b>		<b>Cadena doble</b>	
Nostro codice Our code Unser Kode Notre code Nuestro código	Designazione Designation Benennung Désignation Denominación	Dimensioni / Dimentions Abmessungen / Dimensions Dimensiones					Peso al metro Weight per metre Gewicht pro Meter Poids par mètre Peso por metro Kg/m	Carico di rottura minimo Minimum breaking load Mindestbruchkraft Charge de rupture minimale Carga de rotura minima N	Carico di rottura medio Average breaking load Durchschnittliche Bruchkraft Charge de rupture moyenne Carga de rotura media N
		P mm	W mm	D mm	d mm	C mm			
04N1	6 x 2,8 mm	6,000	2,80	4,00	1,85	7,60	0,11	3000	3200
05N1	8 x 3 mm	8,000	3,00	5,00	2,31	7,90	0,20	5000	5900
06N1	3/8" x 7/32"	9,525	5,72	6,35	3,28	13,15	0,41	9000	10400
08N1	1/2" x 5/16"	12,700	7,75	8,51	4,45	16,70	0,69	18000	19400
10N1	5/8"	15,875	9,65	10,16	5,08	19,50	0,93	22400	27500
12N1	3/4"	19,050	11,68	12,07	5,72	22,50	1,15	29000	32200
16N1	1"	25,400	17,02	15,88	8,28	36,10	2,71	60000	72800
20N1	1" 1/4	31,750	19,56	19,05	10,19	41,30	3,70	95000	106700
24N1	1" 1/2	38,100	25,40	25,40	14,63	53,40	7,10	160000	178000
28N1	1" 3/4	44,450	30,99	27,94	15,90	65,10	8,50	200000	222000
32N1	2"	50,800	30,99	29,21	29,21	17,81	66,00	250000	277500

<b>Catena tripla</b>		<b>Triplex chain</b>		<b>Dreifach Kette</b>		<b>Chaîne triple</b>		<b>Cadena tripla</b>		
Nostro codice Our code Unser Kode Notre code Nuestro código	Designazione Designation Benennung Désignation Denominación	Dimensioni / Dimentions Abmessungen / Dimensions Dimensiones					Peso al metro Weight per metre Gewicht pro Meter Poids par mètre Peso por metro Kg/m	Carico di rottura minimo Minimum breaking load Mindestbruchkraft Charge de rupture minimale Carga de rotura minima N	Carico di rottura minimo Minimum breaking load Mindestbruchkraft Charge de rupture minimale Carga de rotura minima N	Carico di rottura medio Average breaking load Durchschnittliche Bruchkraft Charge de rupture moyenne Carga de rotura media N
		P mm	W mm	D mm	d mm	C mm				
05N3	8 x 3 mm	8,000	3,00	5,00	2,31	5,64	19,40	0,48	11100	13800
06N3	3/8" x 7/32"	9,525	5,72	6,35	3,28	10,24	33,50	1,16	24900	30100
08N3	1/2" x 5/16"	12,700	7,75	8,51	4,45	13,92	45,10	2,03	47500	57800
10N3	5/8"	15,875	9,65	10,16	5,08	16,59	52,70	2,77	66700	84500
12N3	3/4"	19,050	11,68	12,07	5,72	19,46	61,50	3,46	86700	101800
16N3	1"	25,400	17,02	15,88	8,28	31,88	99,80	8,13	160000	203700
20N3	1" 1/4	31,750	19,56	19,05	10,19	36,45	114,20	10,82	250000	290000
24N3	1" 1/2	38,100	25,40	25,40	14,63	48,36	150,10	20,10	425000	493000
28N3	1" 3/4	44,450	30,99	27,94	15,90	59,56	184,20	24,92	530000	609500
32N3	2"	50,800	30,99	29,21	17,81	58,55	183,10	31,56	670000	770500



**Catena a rulli - serie europea ISO/R 606 DIN 8187 a maglie piatte**  
**Roller chain - European series ISO/R 606 DIN 8187 with straight plates**  
**Rollenkette - europäische Serie ISO/R 606 DIN 8187 mit geraden Laschen**  
**Chaîne a rouleaux - série européenne ISO/R 606 DIN 8187 à plaques droites**  
**Cadena de rodillos - serie europea ISO/R 606 DIN 8187 mallas rectas**

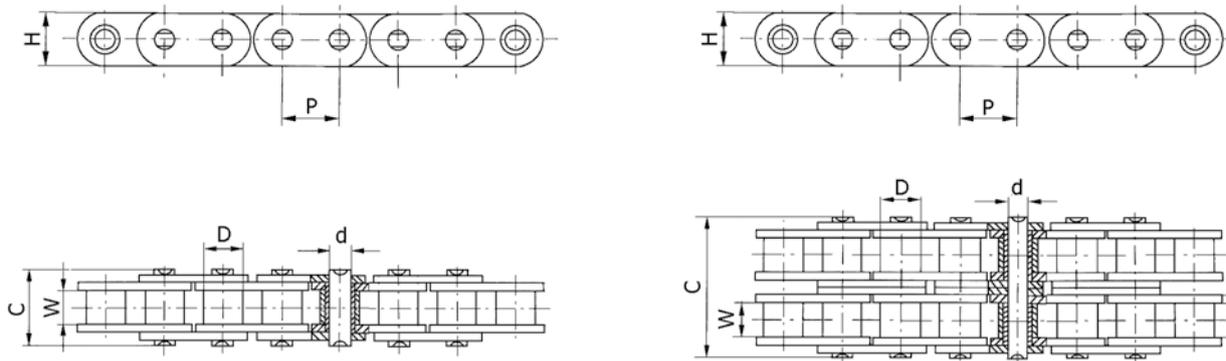

**Catena semplice      Simplex chain      Einfach Kette      Chaîne simple      Cadena simple**

Nostro codice Our code Unser Kode Notre code Nuestro código	Codice ISO ISO code ISO Kode Code ISO Código ISO	Designazione Designation Benennung Désignation Denominación	Dimensioni / Dimentions Abmessungen / Dimensions Dimensiones						Peso al metro Weight per metre Gewicht pro Meter Poids par mètre Peso por metro Kg/m	Carico di rottura minimo Minimum breaking load Mindestbruchkraft Charge de rupture minimale Carga de rotura minima N	Carico di rottura medio Average breaking load Durchschnittliche Bruchkraft Charge de rupture moyenne Carga de rotura media N
			P mm	W mm	D mm	d mm	C mm	H mm			
08P1	C08B-1	1/2"x5/16	12,700	7,75	8,51	4,45	16,70	11,80	0,80	18000	19500
10P1	C10B-1	5/8"	15,875	9,65	10,16	5,08	19,50	14,70	1,06	22400	27900
12P1	C12B-1	3/4"	19,050	11,68	12,07	5,72	22,50	16,00	1,32	29000	32200
16P1	C16B-1	1"	25,400	17,02	15,88	8,28	36,10	24,00	3,49	60000	72800
20P1	C20B-1	1"1/4	31,750	19,56	19,05	10,16	41,30	26,40	4,16	95000	106700
24P1	C24B-1	1"1/2	38,100	25,40	25,40	14,63	53,40	33,20	7,47	160000	178000

**Catena doppia      Duplex chain      Zweifach Kette      Chaîne double      Cadena doble**

Nostro codice Our code Unser Kode Notre code Nuestro código	Codice ISO ISO code ISO Kode Code ISO Código ISO	Designazione Designation Benennung Désignation Denominación	Dimensioni / Dimentions Abmessungen / Dimensions Dimensiones						Peso al metro Weight per metre Gewicht pro Meter Poids par mètre Peso por metro Kg/m	Carico di rottura minimo Minimum breaking load Mindestbruchkraft Charge de rupture minimale Carga de rotura minima N	Carico di rottura medio Average breaking load Durchschnittliche Bruchkraft Charge de rupture moyenne Carga de rotura media N	
			P mm	W mm	D mm	d mm	E mm	C mm				H mm
08P2	C08B-2	1/2"x5/16	12,700	7,75	8,51	4,45	13,92	31,20	11,80	1,45	32000	38700
10P2	C10B-2	5/8"	15,875	9,65	10,16	5,08	16,59	36,10	14,70	2,00	44500	57800
12P2	C12B-2	3/4"	19,050	11,68	12,07	5,72	19,46	42,00	16,00	2,62	57800	66100
16P2	C16B-2	1"	25,400	17,02	15,88	8,28	31,88	68,00	24,00	6,92	106000	133000

**Catena a rulli in acciaio inox AISI 304 - serie europea ISO/R 606 DIN 8187**  
**AISI 304 stainless steel roller chain - European series ISO/R 606 DIN 8187**  
**Rollenkette aus rostfreiem Stahl AISI 304 - europäische Serie ISO/R 606 DIN 8187**  
**Chaîne a rouleaux en acier inox AISI 304 - série européenne ISO/R 606 DIN 8187**  
**Cadena de rodillos en acero inox AISI 304 - serie europea ISO/R 606 DIN 8187**

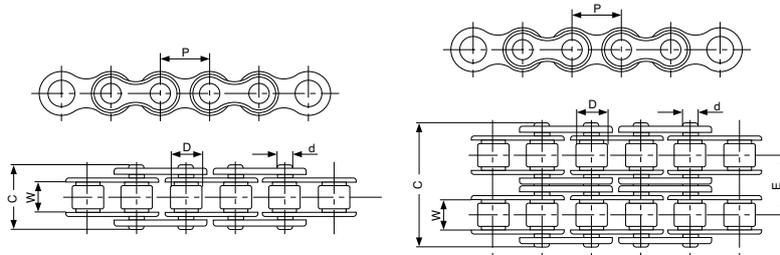

**Catena semplice      Simplex chain      Einfach Kette      Chaîne simple      Cadena simple**

Nostro codice Our code Unser Kode Notre code Nuestro código	Codice ISO ISO code ISO Kode Code ISO Código ISO	Designazione Designation Benennung Désignation Denominación	Dimensioni / Dimentions Abmessungen / Dimensions Dimensiones					Peso al metro Weight per metre Gewicht pro Meter Poids par mètre Peso por metro Kg/m	Carico di rottura minimo Minimum breaking load Mindestbruchkraft Charge de rupture minimale Carga de rotura minima N	Carico di rottura medio Average breaking load Durchschnittliche Bruchkraft Charge de rupture moyenne Carga de rotura media N
			P mm	W mm	D mm	d mm	C mm			
06x1	06 B-1	3/8" x 7/32"	9,525	5,72	6,35	3,28	13,15	0,41	6200	6800
08x1	08 B-1	1/2" x 5/16"	12,700	7,75	8,51	4,45	16,70	0,70	12000	14300
10x1	10 B-1	5/8"	15,875	9,65	10,16	5,08	19,50	0,94	14500	17200
12x1	12 B-1	3/4"	19,050	11,68	12,07	5,72	22,50	1,16	18500	20900
16x1	16 B-1	1"	25,400	17,02	15,88	8,28	36,10	2,73	40000	47600

**Catena doppia      Duplex chain      Zweifach Kette      Chaîne double      Cadena doble**

Nostro codice Our code Unser Kode Notre code Nuestro código	Codice ISO ISO code ISO Kode Code ISO Código ISO	Designazione Designation Benennung Désignation Denominación	Dimensioni / Dimentions Abmessungen / Dimensions Dimensiones						Peso al metro Weight per metre Gewicht pro Meter Poids par mètre Peso por metro Kg/m	Carico di rottura minimo Minimum breaking load Mindestbruchkraft Charge de rupture minimale Carga de rotura minima N	Carico di rottura medio Average breaking load Durchschnittliche Bruchkraft Charge de rupture moyenne Carga de rotura media N
			P mm	W mm	D mm	d mm	E mm	C mm			
06x2	06 B-2	3/8" x 7/32"	9,525	5,72	6,35	3,28	10,24	23,40	0,77	10140	11220
08x2	08 B-2	1/2" x 5/16"	12,700	7,75	8,51	4,45	13,92	31,20	1,34	19200	23220
10x2	10 B-2	5/8"	15,875	9,65	10,16	5,08	16,59	36,10	1,84	26700	33720
12x2	12 B-2	3/4"	19,050	11,68	12,07	5,72	19,46	42,00	2,31	34680	39660
16x2	16 B-2	1"	25,400	17,02	15,88	8,28	31,88	68,00	5,42	63600	79800

**Catena a rulli rinforzata - serie europea ISO/R 606 DIN 8187**  
**Heavy duty roller chain - European series ISO/R 606 DIN 8187**  
**Verstärkte Rollenkette - europäische Serie ISO/R 606 DIN 8187**  
**Chaîne a rouleaux renforcée - série européenne ISO/R 606 DIN 8187**  
**Cadena de rodillos reforzada - serie europea ISO/R 606 DIN 8187**

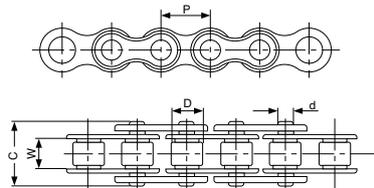

**Catena semplice      Simplex chain      Einfach Kette      Chaîne simple      Cadena simple**

Nostro codice Our code Unser Kode Notre code Nuestro código	Codice ISO ISO code ISO Kode Code ISO Código ISO	Designazione Designation Benennung Désignation Denominación	Dimensioni / Dimentions Abmessungen / Dimensions Dimensiones					Peso al metro Weight per metre Gewicht pro Meter Poids par mètre Peso por metro Kg/m	Carico di rottura minimo Minimum breaking load Mindestbruchkraft Charge de rupture minimale Carga de rotura minima N	Carico di rottura medio Average breaking load Durchschnittliche Bruchkraft Charge de rupture moyenne Carga de rotura media N
			P mm	W mm	D mm	d mm	C mm			
084H1	084 - 1	1/2" x 3/16"	12,70	4,76	7,75	3,96	13,20	0,69	15600	17500

**Catena a rulli rinforzata-serie americana ASA ANSI B 29,1 ISO/R 606 DIN 8188**  
**Heavy duty roller chain-American series ASA ANSI B 29,1 ISO/R 606 DIN 8188**  
**Verstärkte Rollenkette-amerikanische Serie ASA ANSI B 29,1 ISO/R 606 DIN 8188**  
**Chaîne a rouleaux renforcée-série américaine ASA ANSI B 29,1 ISO/R 606 DIN 8188**  
**Cadena de rodillos reforzada-serie americana ASA ANSI B 29,1 ISO/R 606 DIN 8188**

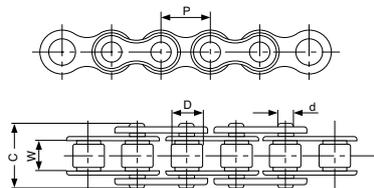

**Catena semplice      Simplex chain      Einfach Kette      Chaîne simple      Cadena simple**

Nostro codice Our code Unser Kode Notre code Nuestro código	Codice ASA "ANSI" ASA "ANSI" code ASA "ANSI" Kode Code ASA "ANSI" Código ASA "ANSI"	Designazione Designation Benennung Désignation Denominación	Dimensioni / Dimentions Abmessungen / Dimensions Dimensiones					Peso al metro Weight per metre Gewicht pro Meter Poids par mètre Peso por metro Kg/m	Carico di rottura minimo Minimum breaking load Mindestbruchkraft Charge de rupture minimale Carga de rotura minima N	Carico di rottura medio Average breaking load Durchschnittliche Bruchkraft Charge de rupture moyenne Carga de rotura media N
			P mm	W mm	D mm	d mm	C mm			
12H1	60H	3/4"	19,05	12,57	11,91	5,94	31,6	1,87	31800	42700
16H1	80H	1"	25,40	15,75	15,88	7,92	39,4	3,10	56700	71400
20H1	100H	1" 1/4	31,75	18,90	19,05	9,53	46,9	4,52	88500	112400
24H1	120H	1" 1/2	38,10	25,22	22,22	11,11	57,5	6,60	127000	160900



**Pulegge dentate**  
**Timing pulleys**  
**Zahnscheiben**  
**Poulies dentées**  
**Poleas dentadas**



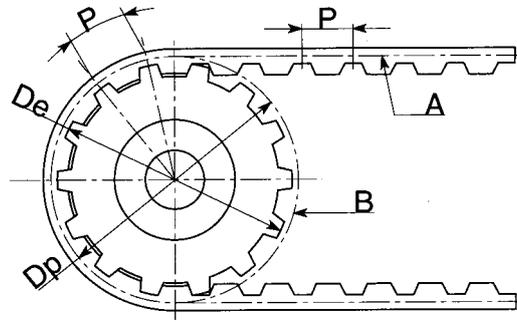

### Simboli

**P** = Passo è la distanza fra gli assi di due denti contigui siano essi quelli della puleggia o della cinghia purché misurata sulla circonferenza o sulla linea primitiva  
**Z** = Numero dei denti puleggia  
**Dp** = Diametro primitivo della puleggia

$$Dp = \frac{P \cdot Z}{\pi}$$

**De** = Diametro esterno puleggia  $De = Dp - N_f$   
**Df** = Diametro flangia  
**d** = Diametro foro  
**Dm** = Diametro mozzo  
**F** = Fascia dentata  
**L** = Lunghezza totale compreso mozzo

### Symbols

**P** = Pitch is the distance between the axes of two adjacent teeth irrespective of whether these teeth are on the pulley or the belt provided that measurement is taken on the circumference or pitch line  
**Z** = Number of pulley teeth  
**Dp** = The diameter of the pulley pitch is obtained from formula

$$Dp = \frac{P \cdot Z}{\pi}$$

**De** = External diameter of pulley  $De = Dp - N_f$   
**Df** = Flange diameter  
**d** = Bore diameter  
**Dm** = Hub diameter  
**F** = Tooth width  
**L** = Total length incl. Hub

### Symbole

**P** = Teilung, d.h. der Achsabstand zweier anliegender Zähne wahlweise der Riemenscheibe oder des Reimens, sofern auf dem Teilkreis bzw. der Wälzlinie gemessen  
**Z** = Zähnezahl der Riemenscheibe  
**Dp** = Teilkreisdurchmesser der Riemenscheibe anhand der Formel

$$Dp = \frac{P \cdot Z}{\pi}$$

**De** = Außendurchmesser der Riemenscheibe  $De = Dp - N_f$   
**Df** = Bordscheibendurchm  
**d** = Bauhörungsdurchm.  
**Dm** = Nabendurchmesser  
**F** = Zahnbreite  
**L** = Gesamtlänge einschl. Nabe

### Symboles

**P** = Pas. Il s'agit de la distance entre les axes de deux dents contiguës qu'il s'agisse de celles de la poulie ou de celles de la courroie pourvu que la distance soit mesurées sur la circonférence ou sur la ligne primitive.  
**Z** = Nombre de dents poulie  
**Dp** = Le diamètre primitif de la poulie s'obtient avec la formule

$$Dp = \frac{P \cdot Z}{\pi}$$

**De** = Diamètre externe poulie  $De = Dp - N_f$   
**Df** = Diamètre flange  
**d** = Diamètre alesage  
**Dm** = Diamètre moyeu  
**F** = Largeur denture  
**L** = Longueur totale moyeu inclus

### Simbolos

**P** = Paso es la distancia entre los ejes de dos dientes contiguos sean estos aquellos de la polea o de la cinta, a condición que se mida en la circunferencia o sobre la linea primitiva.  
**Z** = Número de los dientes de la polea  
**Dp** = Diámetro primitivo de la polea que se obtiene con la fórmula

$$Dp = \frac{P \cdot Z}{\pi}$$

**De** = Diámetro externo de la polea  $De = Dp - N_f$   
**Df** = Diámetro tapeta  
**d** = Diámetro agujero  
**Dm** = Diámetro cepo  
**F** = Anchura diente  
**L** = Longitud total incluido cepo

Tipo	NF
<b>MXL</b>	0,508
<b>XL</b>	0,508
<b>L</b>	0,762
<b>H</b>	1,372
<b>XH</b>	2,794
<b>XXH</b>	3,050

### Guida alla ricerca e alla codificazione delle pulegge dentate:

Le pulegge dentate sono codificate in base ad:  
 - un numero di denti  
 - un passo, espresso da una o più lettere  
 - una larghezza, espressa in centesimi di pollice  
 - una flangiatura eventuale, espressa dalla lettera F.  
**Esempio:**  
 la puleggia 40 XH 200, ha:  
 - n.40 denti;  
 - un passo contraddistinto dalle lettere X ed H  
 - una larghezza pari a 2 pollici.

### Materiali impiegati per la costruzione delle pulegge

Alluminio 6082 T6 UNI 9006/4 idoneo al trattamento anodico.  
 Acciaio C 45 E UNI EN 10083-1.  
 Ghisa EN-GJL-200 UNI EN 1561.  
 Acciaio S235JR (Flange).

### Toothed pulleys are coded on the basis of:

- the number of teeth  
 - pitch, expressed by one or more letters  
 - width, expressed in hundredths of an inch  
 - flange ( if any ) expressed by the letter F.  
**Example:**  
 Pulley 40 XH 200 has:  
 - 40 teeth  
 - pitch identified by letters X and H  
 - a width of 2 inches

### Materials used for making pulleys

Aluminium 6082 T6 UNI 9006/4 suitable for anodic treatment.  
 Steel C 45 E UNI EN 10083-1.  
 Cast iron EN-GJL-200 UNI EN 1561.  
 Steel S235JR (Flanges).

### Bezeichnung und codierung der Zahnriemenscheiben:

Die Zahnriemenscheiben sind nach folgenden Angaben codiert:  
 - einer Zähnezahl  
 - einer Teilung mit einem oder mehreren Buchstaben  
 - einer Breite in Hundertstel Zoll  
 - einer Flanschung mit Buchstaben F.  
**Beispiel:**  
 Riemenscheibe 40 XH 200  
 - 40 Zähne  
 - Teilung mit Buchstaben X und H bezeichnet

### Zur Herstellung der Riemenscheiben eingesetzte Werkstoffe

Aluminium 6082 T6 UNI 9006/4 zur Eloxierung geesignet.  
 Stahl C 45 E UNI EN 10083-1.  
 Gußeisen EN-GJL-200 UNI EN 1561.  
 Stahl S235JR (Bordscheiben).

### Guide a la recherche et a la codification des poulies dentees:

Les poulies dentées sont codifiées sur la base du:  
 - nombre de dents  
 - pas, exprimé par une ou plusieurs lettres  
 - largeur, exprimée en centièmes de pouces  
 - flasquage éventuel exprimé par la lettre F.  
**Exemple:**  
 la poulie 40 XH 200 a:  
 - 40 dents  
 - un pas qui se distingue par les lettres X et H  
 - une largeur égale à 2 pouces

### Matières employées pour la construction des poulies

Aluminium 6082 T6 UNI 9006/4 indiqué pour le traitement anodique.  
 Acier C 45 E UNI EN 10083-1.  
 Fonte EN-GJL-200 UNI EN 1561.  
 Acier S235JR (Flasques).

### Guía a la búsqueda y a la codificación de las poleas dentadas:

Las poleas dentadas son codificadas en base a:  
 - un numero de dientes  
 - un paso, expresado por una o más letras  
 - un ancho, expresado en centésimos de pulgada  
 - un eventual embridado, expresado por la letra F.  
**Ejemplo:**  
 La polea 40 XH 200, posee:  
 - 40 dientes  
 - un paso distinguido con las letras X y H  
 - un ancho igual a 2 pulgadas

### Materiales utilizados para la construcción de las poleas

Aluminio 6082 T6 UNI 9006/4 para el tratamiento anódico.  
 Acero C 45 E UNI EN 10083-1  
 Hierro fundido.  
 EN-GJL-200 UNI EN 1561.  
 Acero S235JR (Tapetas).

# Pulegge per cinghie dentate SYNCHROFLEX / Pulleys for SYNCHROFLEX toothed belts SYNCHROFLEX-Zahnriemenscheiben / Poulies pour courroies dentées SYNCHROFLEX Poleas para correas dentadas SYNCHROFLEX



I diametri esterni figurano nelle tavole relative alle pulegge. I programmi T2,5, T5, T10 e T20 prevedono esclusivamente le forme di dentatura riportate in calce.

The external diameters are set out in the tables relating to pulleys. Programmes T2,5, T5, T10 and T20 adopt exclusively the forms of toothing set out below.

Die Außendurchmesser gehen aus den Tafeln der Riemenscheiben hervor Für die Programme T 2,5, T 5, T 10 und T 20 gelten ausschließlich die untenstehenden Zahnungsformen.

Les diamètres extérieurs figurent dans les tableaux relatifs aux poulies. Les programmes T2,5, T5, T10 et T20 prévoient exclusivement les formes de denture reportées au bas de la page.

Los diámetros externos están indicados en los cuadros correspondientes a las poleas. Los programas T2,5, T5, T10 y T20 prevén exclusivamente las formas de dentadura ilustradas a pie de página.

Fino a Z20 compreso  
**T2,5 se / T5 se / T10 se / T20 se**

Consisting of up to Z20 teeth  
**T2,5 se / T5 se / T10 se / T20 se**

Bis zu einschließlich Z20 Zähne  
**T2,5 se / T5 se / T10 se / T20 se**

Jusqu'à Z20 dents  
**T2,5 se / T5 se / T10 se / T20 se**

Hasta Z20 dientes  
**T2,5 se / T5 se / T10 se / T20 se**

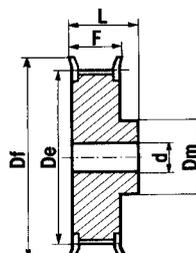
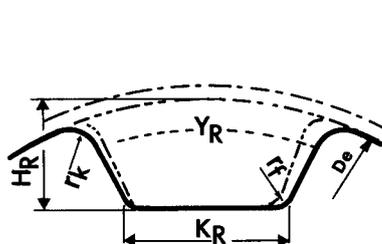

A partire da 21 dent  
**T2,5 / T5 / T10 / T20**

From 21 teeth onward  
**T2,5 / T5 / T10 / T20**

Ab 21 Zähne  
**T2,5 / T5 / T10 / T20**

A partir de 21 dents  
**T2,5 / T5 / T10 / T20**

A partir de 21 dientes  
**T2,5 / T5 / T10 / T20**

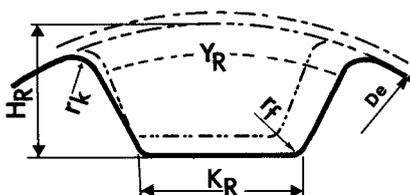
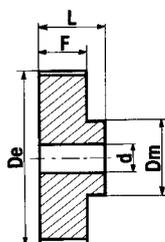

## Simboli

**T...** = Passo  
**Z** = Numero denti puleggia  
**De** = Diametro esterno  
**Df** = Diametro flangia  
**d** = Diametro foro  
**Dm** = Diametro mozzo  
**F** = Fascia dentata  
**L** = Lunghezza totale compreso mozzo

## Symbols

**T...** = Pitch  
**Z** = Number of pulley teeth  
**De** = External diameter  
**Df** = Flange diameter  
**d** = Bore diameter  
**Dm** = Hub diameter  
**F** = Tooth width  
**L** = Total length incl. Hub

## Symbole

**T...** = Teilung  
**Z** = Zähnezahl der Riemenscheibe  
**De** = Aussendurchmesser  
**Df** = Bordscheibendurchmesser  
**d** = Bohrungsdurchmesser.  
**Dm** = Nabendurchmesser  
**F** = Zahnbreite  
**L** = Gesamtlänge einschl. Nabe

## Symboles

**T...** = Pas.  
**Z** = Nombre de dents poulie  
**De** = Diamètre externe  
**Df** = Diamètre flange  
**d** = Diamètre alesage  
**Dm** = Diamètre moyeu  
**F** = Largeur denture  
**L** = Longueur totale moyeu inclus

## Simbolos

**T...** = Paso  
**Z** = Número dientes de la polea  
**De** = Diámetro externo  
**Df** = Diámetro tapeta  
**d** = Diámetro agujero  
**Dm** = Diámetro cepto  
**F** = Anchura diente  
**L** = Longitud total incluido cepto

## Dimensioni dei denti delle pulegge

## Dimensions of the pulley teeth

## Abmessungen der Riemenscheibenzähne

## Dimensions des dents des poulies

## Dimensiones de los dientes de las poleas

Designazione / Designation Bezeichnung / Désignation / Designacion	Simbolo Symbol / Symbol Symbole / Símbolo	T 2,5	T 2,5 se	T 5	T 5 se	T 10	T 10 se	T 20	T 20 se
Profondità di dentatura / Depth of toothing Zahnungstiefe / Profondeur de denture Profundidad de la dentadura	H <sub>r</sub>	1,0	0,75	1,95	1,25	3,40	2,60	6,30	5,2
Larghezza fondo dente / Width of tooth base Breite des Zahnfußes / Largeur du fond de dent Ancho del fondo del diente	K <sub>r</sub>	0,9	1,0	1,50	1,80	3,40	3,60	7,0	7,0
Angolo fondo dente / Angle of tooth base/ Zahnfußwinkel Angle du fond de dent / Angulo del fondo del diente	Y <sub>r</sub>	50°	50°	50°	50°	50°	50°	50°	50°
Raggio sommità dentata / Radius of tooth addendum Zahnspitzenradius / Rayon sommet da la dent Radio de la cumbre del diente	r <sub>k</sub>	0,3	0,3	0,6	0,6	0,8	0,8	1,2	1,2
Raggio base dentata / Radius of tooth base / Zahnfußradius Rayon base de la dent / Radio de la base del diente	r <sub>f</sub>	0,2	0,2	0,4	0,4	0,6	0,6	0,8	0,8

## Valore di equilibratura delle pulegge

Le tolleranze dell'equilibratura dipendono dal diametro e dalla larghezza della flangia. Vedi tabella.

## Values of the balancing on pulleys

The balancing tolerances are depending on the diameter and the facewidth of the pulleys, see table below.

## Werte für das Auswuchten von Riemenscheiben

Die Toleranzen für das Auswuchten sind durch den Durchmesser und die Kranzbreite der Scheiben bedingt. Siehe untenstehende Tabelle.

## Valeur de l'équilibrage exécuté sur les poulies

Les tolérances d'équilibrage dépendent du diamètre et de la largeur de la jante: voir tableau ci-dessous.

## Valores del equilibrado ejecutado sobre las poleas

Las tolerancias de equilibrado dependen del diámetro y de la anchura de banda, véase la tabla más abajo.

Diametro puleggia / Pulley diameters Durchmesser der riemenscheiben Diamètre dea poulies / Diametros da polea	Larghezza flangia / Facewidth Kranzbreite / Largeur jante / Banda	Max. disequilibrio / Max. Unbalance Max. Unwucht / Desquii[brage max. Max. Desequilibrio gr.
200 - 300 300 - 600	63 63	6 10
200 - 300 300 - 600 600 - 1000 1000	63 - 100	10 15 20 30
200 - 300 300 - 600 600 - 1000 1000	100 - 200	20 30 40 60
200 - 300 300 - 600  1000	200	30 45 60 90

L'equilibratura non viene eseguita per pulegge con diametro inferiore a 200 mm e con flangia inferiore a 63 mm.

Queste pulegge vengono lavorate completamente e hanno piccole dimensioni. Il costo dell'eventuale equilibratura sarebbe superiore al prezzo della puleggia stesso.

The balancing is not done on pulleys with a diameter smaller than 200 mm and with a facewidth up to 63 mm, these pulleys are fully machined and have reduced dimensions.

The cost of eventual balancing would be almost more than the cost of the total pulley.

Die Riemenscheiben mit Durchmesser kleiner als 200 mm und mit Kranzbreite bis 63 mm werden nicht ausgewuchtet, weil diese Scheiben aiseitig bearbeitet werden und verminderte Abmessungen haben.

Preis bei eventuelier Auswuchtung wird immer mehr sein als Preis für komplette Scheibe.

L'équilibrage n'est pas effectué pour les poulies avec diamètre au-des-sous de 200 mm et avec jante inférieure à 63 mm.

Ces poulies étant usinées entièrement et de petites dimensions, le coût de l'équilibrage serait supérieur au prix de la poulie.

No se efectua el equilibrado para las poleas con diámetro inferior a 200 mm y con banda hasta 63 mm puesto que, siendo estas poleas completamente mecanicadas y de dimensiones reducidas, el coste del eventual equilibrado seria casi siempre superior al coste de la polea misma.

## Fosfatizzazione

Questo trattamento viene eseguito sulle pulegge in ghisa per ottenere una protezione antiossidante senza modificare nello stesso tempo le dimensioni del profilo e la forma del pezzo trattato.

Il procedimento di fosfatizzazione, produce sulla superficie dei pezzi un deposito microcristallino a base di fosfati di manganese e di ferro, ed è successivamente impregnato in un bagno di olio protettivo, aumentando così la resistenza agli agenti ossidanti della superficie microcristallina stessa.

Inoltre, la fosfatizzazione dà ai pezzi trattati, un aspetto estetico più gradevole dato dal colore grigio-nero che si produce sulla superficie.

## Phosphating

This treatment is made on cast iron pulleys in order to obtain a good antioxidizing protection, without modifying dimensionally the profiles and forms of the treated parts.

The phosphating process, that produces on the surfaces of pieces a thin microcrystalline deposit with a basis of manganese and iron phosphates, is completed by an impregnation in protective oils that improves the resistance to the oxidizing agents of the microcrystalline coat itself.

In addition to this, the phosphating gives, to the treated parts, a pleasant aesthetic appearance, due to the black-gray colour produced on their surface.

## Phosphatierung

Dieser Oberflächenbehandlung werden die Scheiben aus Grauguss unterzogen, um einen guten Rostschutz zu erhalten, der die Abmessungen von Profilen und Formen der behandelten Teile nicht ändert.

Beim Phosphatierungsverfahren wird auf der Materialoberfläche ein mikrokristalliner Belag aus Mangan- und Eisenphosphaten gebildet, der dann mit einer Ölschicht imprägniert wird, um die Oberfläche noch beständiger gegen Verrosten der mikrokristallinen Schicht zu machen.

Ausserdem verleiht dieses Verfahren den Oberflächenbehandelten Teilen ein besseres Aussehen durch das Zustandekommen der grauschwarzen Oberflächenfarbe.

## Phosphatation

Ce traitement est exécuté sur les poulies en fonte pour obtenir une bonne protection antioxydante sans modifier dimensionnellement les profils et les formes des pièces traitées.

Le procédé de phosphatation, qui produit sur les surfaces des pièces un fin dépôt microcristallin à base de phosphates de manganese et de fer, est complete per une imprégnation dans d'huiles protectrices qui augmente la résistance aux agents oxydants de la couche microcristalline même.

En plus de cela, la phosphatation donne aux pièces traitées un agréable aspect esthétique dû à la couleur grise-noire qu'elle produit sur leur surface.

## Fosfatación

Este tratamiento se efectua sobre las poleas en hierro fundido con el fin de obtener una buena protección antioxydante sin modificar dimensionalmente los perfiles y las formas de los particulares tratados.

El procedimiento da fosfatación que genera sobre las superficies un fino depósito microcristalino a base de fosfatos de manganese y hierro, es completado con una impregnación de aceites protectivos que aumenta la resistencia a los agentes oxidantes del mismo estrato microcristalino.

Además de esto, la fosfatación confiere a los particulares tratados un agradable aspecto estético debido al color gris- negro que genera sobre su superficie.



## Brunitura

Questo trattamento viene eseguito sulle pulegge in acciaio principalmente per migliorarne l'aspetto estetico e prevede la formazione di un sottile strato superficiale di ossido ferroso/ferrico nero in grado di sopportare severe deformazioni.

Il trattamento di brunitura è preceduto da una sgrassatura chimica (decapaggio) che porta alla dissossidazione completa delle pulegge da trattare.

A brunitura avvenuta è altresì prevista la oliatura delle pulegge stesse, in modo da proteggere lo strato superficiale ottenuto dalla ossidazione atmosferica.

La brunitura pertanto è un procedimento di colorazione del ferro e non di protezione dello stesso contro la corrosione. Tale protezione è tuttavia determinata dalla successiva oliatura.

## Black oxidizing

This treatment is carried out on steel pulleys mostly for appearance.

The resulting black iron oxide coating will not chip, peel, flake or rub off.

A chemical degreasing pre-treatment (pickling) is made before black oxidizing and causes the deoxidation of the pulleys.

After black finishing, pulleys are oiled in order to protect surface from atmospheric oxidation.

This treatment therefore will merely produce a black finish coating but it is not a corrosion-resistant treatment. To achieve a level of corrosion resistance, oil is applied on the pulleys.

## Brünieren

Diese Oberflächenbehandlung wird auf Riemenscheiben aus Stahl ausgeführt, um deren Aussehen zu verbessern. Bei diesem Verfahren entsteht auf der Oberfläche eine dünne schwarze Eisenoxidschicht, die in hohem Maße biege- und abriebfest ist.

Die zu behandelnden Riemenscheiben werden vor dem eigentlichen Brüniervorgang in einer wässrig alkalischen Entfettung gereinigt, wodurch die vorhandenen Oxidschichten beseitigt werden.

Nach dem Brünieren werden die Teile noch beölt, was sich positiv auf den Korrosionsschutz auswirkt.

Unter Brünieren versteht man deshalb eine Schwarzfärbung von Eisenoberflächen und kein Verfahren zum Korrosionsschutz, der jedoch durch anschließendes Beölen garantiert wird.

## Brunissage

Ce traitement est effectué sur les poulies en acier pour en améliorer l'aspect esthétique et comporte la formation sur la surface d'une couche mince d'oxyde ferreux/ferrique noir capable d'endurer de sévères déformations.

Le traitement de brunissage est précédé par un dégraissage chimique (décapage) qui amène à la désoxydation totale des poulies à traiter.

A la fin du traitement de brunissage le poulies sont huilées pour en protéger la couche superficielle contre l'oxydation atmosphérique.

Le brunissage est donc un procédé de coloration du fer et non de protection du même contre la corrosion, protection qui est pourtant déterminée par le huilage suivant.

## Pavonado

Este tratamiento se realiza en las poleas en acero, sobre todo para mejorar el aspecto exterior, y contempla la formación de una sutil capa superficial de óxido ferroso, capaz de soportar deformaciones considerables. El tratamiento de pavonado está precedido por un desgrase químico (decapado), que lleva a la total desoxidación de las poleas a tratar.

Al acabar del pavonado, también está prevista la lubricación de las poleas mismas, de manera que la capa superficial obtenida de la oxidación resulte protegida. El pavonado es por lo tanto un procedimiento de coloración del hierro, y no de protección del mismo de la corrosión. Tal protección se obtiene de todos modos con la siguiente lubricación.

## Tolleranza di fabbrica della puleggia / Manufacture tolerances for pulleys Herstellertoleranz für die scheiben / Tolerances de fabrication pour les poulies Tolerancias de fabricacion de las poleas

De puleggia / pulley O.D. / Scheibe Aussen ø / De poulie / De polea	Tolleranza / Tolerances / Tolerancia / Tolerance / Toleranz mm
da/from ø 0 a/to ø 30	-0 +0,05
da/from ø 31 a/to ø 50	-0 +0,08
da/from ø 51 a/to ø 100	-0 +0,10
da/from ø 101 a/to ø 180	-0 +0,13
da/from ø 181 a/to ø 310	-0 +0,15
da/from ø 311 a/to ø 510	-0 +0,18
da/from ø 511	-0 +0,20

## Eccentricità

Il foro e il diametro esterno devono essere concentrici in base alle tolleranze indicate:

## Eccentricity

The bore and the outside diameter must be concentric, based on the undermentioned tolerances:

## Unmittigkeit

Bohrung und Aussendurchmesser müssen unter bezug auf die folgend genannten Toleranzen konzentrisch sein:

## Excentricité

L'alésage et le diamètre extérieur doivent être concentriques en base aux tolérances sous indiquées:

## Excentricidad

El agujero y el diametro exterior deben ser concéntricos en base a las tolerancias indicadas abajo:

ø esterno / ø outside ø Aussen / ø extcrieur / ø exterior	Eccentricità totale (indicazione del comparatore) / Total eccentricity (total indication of diai gauge) Gesamtexzentrizität (gesamtgabe des komparators) / Excentricité totale (indication totale du comparateur) Excentricidad total (lecutura comparador)mm
fino / to / bis zu / jusqu'à / hasta 200	0,10 mm
oltre / over / über / plus de / más de 200	0,0005 per mm di diametro * / per mm of diametre * pro mm Durchmesser * / par mm de diamètre * / por cada mm de diametro *

\* Questo valore non può superare la tolleranza sul ø esterno.

\* This value may not exceed the tolerance on outside.

\* Dieser Wert darf die Toleranz auf dem aussen ø nicht übersteigen.

\* Cette valeur ne peut pas dépasser la tolérance sur le ø extérieur.

\* Este valor no puede exceder la tolerancia sobre el ø exterior.

Per flangie e barre dentate consultare il ns. catalogo pag. 156 - 157 - 173 - 174 - 179 - 180 - 195 - 196

For flanges and timing bars, please see our catalogue pages 156 - 157 - 173 - 174 - 179 - 180 - 195 - 196

For Bordscheiben und Zahnstangen, bitte sehe unsere Catalog Seiten 156 - 157 - 173 - 174 - 179 - 180 - 195 - 196

Pour flasques et barreaux dentés, voir notre catalogue pages 156 - 157 - 173 - 174 - 179 - 180 - 195 - 196

Para tapatas y barras dentadas, ver nuestro catalogo paginas 156 - 157 - 173 - 174 - 179 - 180 - 195 - 196



**Pulegge per cinghie dentate**  
**Timing belt pulleys**  
**Zahnriemenscheiben**  
**Poulies pour courroies dentées**  
**Poleas para correas dentadas**

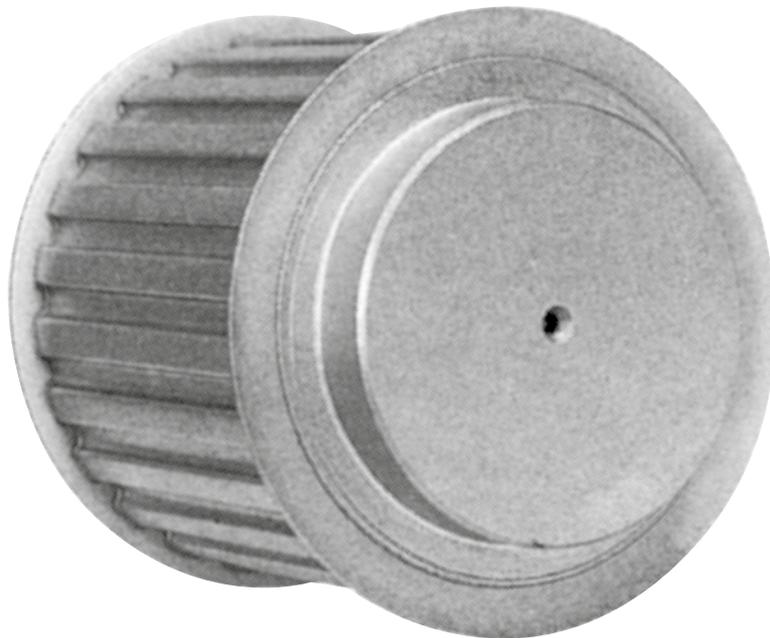

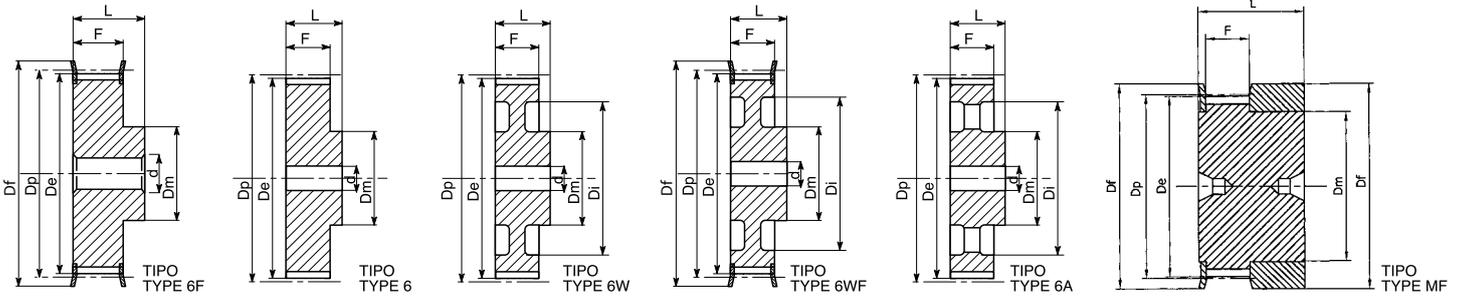

### MXL 025 - 0,080" (2,032 mm)

Caratteristiche Features Merkmale Características	Codice Code symbol Fabriknummer Code symbole Numero de fabrica	Nostro codice Our code Unser kode Notre code Nuestro codigo	Tipo Type Typ Type Tipo	Tipo flangia Flanges type Bordscheiben Typ Type flasques Tipo tapetas	N. denti N. of teeth Zahnezahl N. bre de dents Cantidad de dientes	Dp	De	Df	Dm	Di	F	L	Foro stock Stock bore Vor bohrung Alesage en stock Agujero de stock	Peso Weight Gewicht Poids Peso Kg
Alluminio / Aluminium / Aluminum / Aluminium / Aluminium / Aluminium con flangia / with flanges mit Flanges / avec flasques con tapetas	<b>16 MXL 025</b>	<b>MXL 2516</b>	MF	F02	16	10,35	9,84	15,0	8,0	-	8,5	16	-	-
	<b>18 MXL 025</b>	<b>MXL 2518</b>	MF	F03	18	11,64	11,12	16,0	9,5	-	8,5	16	-	-
	<b>20 MXL 025</b>	<b>MXL 2520</b>	MF	F03	20	12,94	12,43	16,0	9,5	-	8,5	16	-	-
	<b>22 MXL 025</b>	<b>MXL 2522</b>	6F	F04	22	14,23	13,72	17,5	10,0	-	11,0	16	3	3
	<b>24 MXL 025</b>	<b>MXL 2524</b>	6F	F06	24	15,52	15,01	20,0	10,0	-	11,0	16	3	3
	<b>28 MXL 025</b>	<b>MXL 2528</b>	6F	F08	28	18,11	17,60	25,0	11,0	-	11,0	16	3	3
	<b>30 MXL 025</b>	<b>MXL 2530</b>	6F	F08	30	19,40	18,90	25,0	12,0	-	11,0	16	4	4
	<b>32 MXL 025</b>	<b>MXL 2532</b>	6F	F08	32	20,70	20,19	25,0	14,0	-	11,0	16	4	4
	<b>36 MXL 025</b>	<b>MXL 2536</b>	6F	F09	36	23,29	22,78	28,0	16,0	-	11,0	16	4	4
	<b>40 MXL 025</b>	<b>MXL 2540</b>	6F	F10	40	25,87	25,37	32,0	18,0	-	11,0	16	4	4
	<b>42 MXL 025</b>	<b>MXL 2542</b>	6F	F10	42	27,17	26,67	32,0	18,0	-	11,0	16	5	5
	<b>44 MXL 025</b>	<b>MXL 2544</b>	6F	F13	44	28,46	27,95	37,0	18,0	-	11,0	16	5	5
	Alluminio / Aluminium / Aluminium / Aluminium / Aluminium / Aluminium senza flangia / without flanges / ohne Flanschen sans flasques / sin tapetas	<b>48 MXL 025</b>	<b>MXL 2548</b>	6	-	48	31,05	30,54	-	20,0	-	11,0	16	5
<b>60 MXL 025</b>		<b>MXL 2560</b>	6	-	60	38,81	38,30	-	24,0	-	11,0	16	5	5
<b>72 MXL 025</b>		<b>MXL 2572</b>	6	-	72	46,57	46,06	-	25,0	-	11,0	16	6	6

### XL 037 - 1/5" (5,08 mm)

Caratteristiche Features Merkmale Características	Codice Code symbol Fabriknummer Code symbole Numero de fabrica	Nostro codice Our code Unser kode Notre code Nuestro codigo	Tipo Type Typ Type Tipo	Tipo flangia Flanges type Bordscheiben Typ Type flasques Tipo tapetas	N. denti N. of teeth Zahnezahl N. bre de dents Cantidad de dientes	Dp	De	Df	Dm	Di	F	L	Foro stock Stock bore Vor bohrung Alesage en stock Agujero de stock	Peso Weight Gewicht Poids Peso Kg
Alluminio / Aluminium / Aluminium / Aluminium / Aluminium / Aluminium con flangia / with flanges mit Flanges / avec flasques / con tapetas	<b>10 XL 037</b>	<b>XA37010 XC37010</b>	6F	F07	10	16,17	15,66	23	9,5	-	14,3	20	4	0,02
	<b>11 XL 037</b>	<b>XA37011 XC37011</b>	6F	F07	11	17,79	17,28	23	9,5	-	14,3	20	4	0,02
	<b>12 XL 037</b>	<b>XA37012 XC37012</b>	6F	F08	12	19,40	18,90	25	10	-	14,3	20	4	0,03
	<b>13 XL 037</b>	<b>XA37013 XC37013</b>	6F	F08	13	21,02	20,51	25	10	-	14,3	20	4	0,04
	<b>14 XL 037</b>	<b>XA37014 XC37014</b>	6F	F09	14	22,64	22,13	28	15	-	14,3	20	4	0,05
	<b>15 XL 037</b>	<b>XA37015 XC37015</b>	6F	F09	15	24,26	23,75	28	15	-	14,3	20	6	0,05
	<b>16 XL 037</b>	<b>XA37016 XC37016</b>	6F	F10	16	25,87	25,36	32	16	-	14,3	20	6	0,06
	<b>17 XL 037</b>	<b>XA37017 XC37017</b>	6F	F10	17	27,49	26,98	32	20	-	14,3	20	6	0,07
	<b>18 XL 037</b>	<b>XA37018 XC37018</b>	6F	F11	18	29,11	28,60	35	20	-	14,3	20	6	0,08
	<b>19 XL 037</b>	<b>XA37019 XC37019</b>	6F	F11	19	30,72	30,22	35	20	-	14,3	22	6	0,09
	<b>20 XL 037</b>	<b>XA37020 XC37020</b>	6F	F14	20	32,34	31,83	38	23,5	-	14,3	22	6	0,11
	<b>21 XL 037</b>	<b>XA37021 XC37021</b>	6F	F14	21	33,96	33,45	38	23,5	-	14,3	22	6	0,12
	<b>22 XL 037</b>	<b>XA37022 XC37022</b>	6F	F15	22	35,57	35,07	42	25	-	14,3	22	6	0,13
	<b>24 XL 037</b>	<b>XA37024 XC37024</b>	6F	F17	24	38,81	38,30	44	30	-	14,3	22	6	0,15
	<b>26 XL 037</b>	<b>XA37026 XC37026</b>	6F	F18	26	42,04	41,53	48	30	-	14,3	22	8	0,19
	<b>27 XL 037</b>	<b>XA37027 XC37027</b>	6F	F18	27	43,66	43,15	48	34	-	14,3	22	8	0,20
	<b>28 XL 037</b>	<b>XA37028 XC37028</b>	6F	F19	28	45,28	44,77	51	34	-	14,3	22	8	0,22
	<b>29 XL 037</b>	<b>XA37029 XC37029</b>	6F	F19	29	46,89	46,39	51	34	-	14,3	22	8	0,22
	<b>30 XL 037</b>	<b>XA37030 XC37030</b>	6F	F20	30	48,51	48,00	54	38	-	14,3	22	8	0,11
	<b>32 XL 037</b>	<b>XA37032 XC37032</b>	6F	F21	32	51,74	51,24	57	38	-	14,3	25	8	0,12
	Altern. / Altern. Altern. / Altern. Acier / Acero	<b>34 XL 037</b>	<b>XA37034 XC37034</b>	6		34	54,98	54,47	-	45	-	14,3	25	8
<b>35 XL 037</b>		<b>XA37035 XC37035</b>	6		35	56,60	56,09	-	45	-	14,3	25	8	0,13
<b>36 XL 037</b>		<b>XA37036 XC37036</b>	6		36	58,21	57,70	-	45	-	14,3	25	8	0,14
<b>38 XL 037</b>		<b>XA37038 XC37038</b>	6		38	61,45	60,94	-	45	-	14,3	25	8	0,16
<b>39 XL 037</b>		<b>XA37039 XC37039</b>	6		39	63,06	62,56	-	45	-	14,3	25	8	0,17
<b>40 XL 037</b>		<b>XA37040 XC37040</b>	6		40	64,68	64,17	-	45	-	14,3	25	8	0,17
<b>41 XL 037</b>		<b>XA37041 XC37041</b>	6		41	66,30	65,79	-	45	-	14,3	25	8	0,18
<b>42 XL 037</b>		<b>XA37042 XC37042</b>	6		42	67,91	67,41	-	45	-	14,3	25	8	0,18
<b>43 XL 037</b>		<b>XA37043 XC37043</b>	6		43	69,53	69,02	-	45	-	14,3	25	8	0,19
<b>44 XL 037</b>		<b>XA37044 XC37044</b>	6		44	71,15	70,64	-	45	-	14,3	25	8	0,19
<b>45 XL 037</b>		<b>XA37045 XC37045</b>	6W		45	72,77	72,26	-	45	61	14,3	25	10	0,19
<b>46 XL 037</b>		<b>XA37046 XC37046</b>	6W		46	74,38	73,87	-	45	61	14,3	25	10	0,19
<b>47 XL 037</b>		<b>XA37047 XC37047</b>	6W		47	76,00	75,49	-	45	61	14,3	25	10	0,19
<b>48 XL 037</b>		<b>XA37048 XC37048</b>	6W		48	77,62	77,11	-	45	61	14,3	25	10	0,19
<b>49 XL 037</b>	<b>XA37049 XC37049</b>	6W		49	79,23	78,73	-	45	61	14,3	25	10	0,22	
<b>52 XL 037</b>	<b>XA37052 XC37052</b>	6W		52	84,08	83,58	-	45	67	14,3	25	10	0,22	
<b>56 XL 037</b>	<b>XA37056 XC37056</b>	6W		56	90,55	90,04	-	45	80	14,3	25	10	0,25	
<b>57 XL 037</b>	<b>XA37057 XC37057</b>	6W		57	92,17	91,66	-	45	80	14,3	25	10	0,25	
<b>58 XL 037</b>	<b>XA37058 XC37058</b>	6W		58	93,79	93,28	-	45	80	14,3	25	10	0,25	
<b>59 XL 037</b>	<b>XA37059 XC37059</b>	6W		59	95,40	94,90	-	45	80	14,3	25	10	0,25	
<b>60 XL 037</b>	<b>XA37060 XC37060</b>	6W		60	97,02	96,51	-	45	80	14,3	25	10	0,25	
<b>68 XL 037</b>	<b>XA37068 XC37068</b>	6W		68	109,96	109,45	-	45	100	14,3	25	10	0,30	
<b>69 XL 037</b>	<b>XA37069 XC37069</b>	6W		69	111,57	111,07	-	45	100	14,3	25	10	0,30	
<b>70 XL 037</b>	<b>XA37070 XC37070</b>	6W		70	113,19	112,68	-	45	100	14,3	25	10	0,30	
<b>71 XL 037</b>	<b>XA37071 XC37071</b>	6W		71	114,81	114,30	-	45	100	14,3	25	10	0,30	
<b>72 XL 037</b>	<b>XA37072 XC37072</b>	6W		72	116,42	115,92	-	45	100	14,3	25	10	0,30	

# Pulegge per cinghie dentate / Timing belt pulleys Zahnriemenscheiben / Poulies pour courroies dentées / Poleas para correas dentadas



## L 050 - 3/8" (9,525 mm)

Caratteristiche Features Merkmale Características Características	Codice Code symbol Fabriknummer Code symbole Numero de fabrica	Nostro codice Our code Unser kode Notre code Nuestro codigo	Tipo Type Typ Type Tipo	Tipo flangia Flanges type Bordscheiben Typ Type flasques Tipo tapetas	N. denti N. of teeth Zahnezahl N. bre de dents Cantidad de dientes	Dp	De	Df	Dm	Di	F	L	Foro stock Stock bore Vor bohrung Alesage en stock Agujero de stock	Peso Weight / Gewicht Poids / Peso Kg	
Acciaio / Steel / Stahl Acier / Acero	con flangia / with flanges mit Flanges / avec flasques / con tapetas	10L050	L50010	6F	F13	10	30,32	29,56	37	20	—	19,0	28	8	0,11
		11L050	L50011	6F	F13	11	33,35	32,59	37	22	—	19,0	30	8	0,14
		12L050	L50012	6F	F16	12	36,38	35,62	43	24	—	19,0	30	8	0,17
		13L050	L50013	6F	F17	13	39,41	38,65	44	28	—	19,0	30	8	0,18
		14L050	L50014	6F	F18	14	42,45	41,68	48	28	—	19,0	30	8	0,22
		15L050	L50015	6F	F19	15	45,48	44,72	51	34	—	19,0	30	8	0,28
		16L050	L50016	6F	F20	16	48,51	47,75	54	36	—	19,0	32	8	0,35
		17L050	L50017	6F	F21	17	51,54	50,78	57	36	—	19,0	32	10	0,36
		18L050	L50018	6F	F22	18	54,57	53,81	60	40	—	19,0	32	10	0,42
		19L050	L50019	6F	F24	19	57,61	56,84	64	40	—	19,0	32	10	0,45
		20L050	L50020	6F	F25	20	60,64	59,88	66	40	—	19,0	32	10	0,48
		21L050	L50021	6F	F26	21	63,67	62,91	70	45	—	19,0	32	10	0,57
		22L050	L50022	6F	F27	22	66,70	65,94	75	45	—	19,0	32	10	0,59
		23L050	L50023	6F	F28	23	69,73	68,97	79	55	—	19,0	32	10	0,61
		24L050	L50024	6F	F28	24	72,77	72,00	79	55	—	19,0	32	10	0,80
		25L050	L50025	6F	F29	25	75,80	75,04	83	58	—	19,0	32	10	0,85
		26L050	L50026	6F	F30	26	78,83	78,07	87	58	—	19,0	32	11	0,90
		27L050	L50027	6F	F30	27	81,86	81,10	87	58	—	19,0	32	11	0,91
		28L050	L50028	6F	F31	28	84,89	84,13	91	58	—	19,0	32	11	0,95
		29L050	L50029	6F	F32	29	87,93	87,16	93	58	—	19,0	32	11	1,00
		30L050	L50030	6F	F33	30	90,96	90,20	97	70	—	19,0	32	11	1,07
		32L050	L50032	6F	F34	32	97,02	96,26	102	70	—	19,0	32	11	1,23
		33L050	L50033	6F	F35	33	100,05	99,29	106	70	—	19,0	32	11	1,30
		34L050	L50034	6F	F36	34	103,08	102,32	112	70	—	19,0	32	11	1,37
		35L050	L50035	6F	F36	35	106,12	105,35	112	70	—	19,0	32	11	1,44
		36L050	L50036	6F	F37	36	109,15	108,39	115	70	—	19,0	32	11	1,50
		40L050	L50040	6WF	F40	40	121,28	120,51	128	70	100	19,0	32	11	1,77
		41L050	L50041	6WF	F41	41	124,31	123,55	131	70	103	19,0	32	11	1,84
		42L050	L50042	6WF	F42	42	127,34	126,58	135	70	106	19,0	32	11	1,97
		44L050	L50044	6WF	F45	44	133,40	132,64	142	70	112	19,0	32	11	2,20
		45L050	L50045	6WF	F45	45	136,44	135,67	142	70	115	19,0	32	11	2,27
		47L050	L50047	6WF	F48	47	142,50	141,74	150	70	121	19,0	32	11	2,45
		48L050	L50048	6WF	F48	48	145,53	144,77	150	70	124	19,0	32	11	2,67
		49L050	L50049	6W		49	148,56	147,80	—	70	127	19,0	32	14	1,80
		50L050	L50050	6W		50	151,60	150,83	—	70	130	19,0	32	14	1,90
		52L050	L50052	6W		52	157,66	156,90	—	70	136	19,0	32	14	2,10
56L050	L50056	6W		56	169,79	169,02	—	70	149	19,0	32	14	2,18		
57L050	L50057	6W		57	172,82	172,06	—	70	152	19,0	32	14	2,47		
60L050	L50060	6W		60	181,91	181,15	—	75	160	19,0	42	14	3,10		
65L050	L50065	6A		65	197,07	196,31	—	75	176	19,0	42	14	3,20		
66L050	L50066	6A		66	200,11	199,34	—	75	179	19,0	42	14	3,23		
72L050	L50072	6A		72	218,30	217,53	—	75	197	19,0	42	14	4,86		
84L050	L50084	6A		84	254,68	253,92	—	75	233	19,0	42	14	5,00		
90L050	L50090	6A		90	272,87	272,11	—	75	252	19,0	42	14	5,50		
96L050	L50096	6A		96	291,06	290,30	—	75	269	19,0	42	14	6,00		
120L050	L50120	6A		120	363,83	363,07	—	75	342	19,0	42	14	8,50		

## L 075 - 3/8" (9,525 mm)

Caratteristiche Features Merkmale Características Características	Codice Code symbol Fabriknummer Code symbole Numero de fabrica	Nostro codice Our code Unser kode Notre code Nuestro codigo	Tipo Type Typ Type Tipo	Tipo flangia Flanges type Bordscheiben Typ Type flasques Tipo tapetas	N. denti N. of teeth Zahnezahl N. bre de dents Cantidad de dientes	Dp	De	Df	Dm	Di	F	L	Foro stock Stock bore Vor bohrung Alesage en stock Agujero de stock	Peso Weight / Gewicht Poids / Peso Kg	
Acciaio / Steel / Stahl Acier / Acero	con flangia / with flanges mit Flanges / avec flasques / con tapetas	10L075	L75010	6F	F13	10	30,32	29,56	37	20	—	25,4	38	8	0,15
		11L075	L75011	6F	F13	11	33,35	32,59	37	22	—	25,4	38	8	0,17
		12L075	L75012	6F	F16	12	36,38	35,62	43	24	—	25,4	38	8	0,22
		13L075	L75013	6F	F17	13	39,41	38,65	44	28	—	25,4	38	8	0,25
		14L075	L75014	6F	F18	14	42,45	41,68	48	28	—	25,4	38	11	0,28
		15L075	L75015	6F	F19	15	45,48	44,72	51	34	—	25,4	38	11	0,38
		16L075	L75016	6F	F20	16	48,51	47,75	54	36	—	25,4	38	11	0,43
		17L075	L75017	6F	F21	17	51,54	50,78	57	36	—	25,4	38	11	0,44
		18L075	L75018	6F	F22	18	54,57	53,81	60	40	—	25,4	38	11	0,52
		19L075	L75019	6F	F24	19	57,61	56,84	64	40	—	25,4	38	11	0,56
		20L075	L75020	6F	F25	20	60,64	59,88	66	40	—	25,4	38	11	0,59
		21L075	L75021	6F	F26	21	63,67	62,91	70	45	—	25,4	38	11	0,64
		22L075	L75022	6F	F27	22	66,70	65,94	75	45	—	25,4	38	11	0,69
		23L075	L75023	6F	F28	23	69,73	68,97	79	55	—	25,4	38	11	0,76
		24L075	L75024	6F	F28	24	72,77	72,00	79	55	—	25,4	38	11	0,87
		25L075	L75025	6F	F29	25	75,80	75,04	83	58	—	25,4	38	11	0,95
		26L075	L75026	6F	F30	26	78,83	78,07	87	58	—	25,4	38	11	1,06
		27L075	L75027	6F	F30	27	81,86	81,10	87	58	—	25,4	38	11	1,18
		28L075	L75028	6F	F31	28	84,89	84,13	91	58	—	25,4	38	11	1,19
		29L075	L75029	6F	F32	29	87,93	87,16	93	58	—	25,4	38	11	1,25
		30L075	L75030	6F	F33	30	90,96	90,20	97	70	—	25,4	38	11	1,33
		32L075	L75032	6F	F34	32	97,02	96,26	102	70	—	25,4	38	11	1,54
		33L075	L75033	6F	F35	33	100,05	99,29	106	70	—	25,4	38	11	1,63
		34L075	L75034	6F	F36	34	103,08	102,32	112	70	—	25,4	38	11	1,37
		35L075	L75035	6F	F36	35	106,12	105,35	112	70	—	25,4	38	11	1,80
		36L075	L75036	6F	F37	36	109,15	108,39	115	70	—	25,4	38	11	1,89
		40L075	L75040	6WF	F40	40	121,28	120,51	128	70	100	25,4	38	11	2,35
		41L075	L75041	6WF	F41	41	124,31	123,55	131	70	103	25,4	38	11	2,40
		42L075	L75042	6WF	F42	42	127,34	126,58	135	70	106	25,4	38	11	2,53
		44L075	L75044	6WF	F45	44	133,40	132,64	142	70	112	25,4	38	11	2,75
		45L075	L75045	6WF	F45	45	136,44	135,67	142	70	115	25,4	38	11	2,86
		47L075	L75047	6WF	F48	47	142,50	141,74	150	70	121	25,4	38	11	3,02
		48L075	L75048	6WF	F48	48	145,53	144,77	150	70	124	25,4	38	11	3,19
		49L075	L75049	6W		49	148,56	147,80	—	70	127	25,4	38	14	2,10
		50L075	L75050	6W		50	151,60	150,83	—	70	130	25,4	38	14	2,20
		52L075	L75052	6W		52	157,66	156,90	—	70	136	25,4	38	14	2,38
56L075	L75056	6W		56	169,79	169,02	—	70	149	25,4	38	14	2,49		
57L075	L75057	6W		57	172,82	172,06	—	70	152	25,4	38	14	2,73		
60L075	L75060	6W		60	181,91	181,15	—	75	160	25,4	45	14	3,44		
65L075	L75065	6A		65	197,07	196,31	—	75	176	25,4	45	14	3,50		
66L075	L75066	6A		66	200,11	199,34	—	75	179	25,4	45	14	3,60		
72L075	L75072	6A		72	218,30	217,53	—	75	197	25,4	45	14	4,58		
84L075	L75084	6A		84	254,68	253,92	—	75	233	25,4	45	14	5,60		
90L075	L75090	6A		90	272,87	272,11	—	75	252	25,4	45	14	6,50		
96L075	L75096	6A		96	291,06	290,30	—	75	269	25,4	45	14	7,00		
120L075	L75120	6A		120	363,83	363,07	—	75	342	25,4	45	14	10,00		

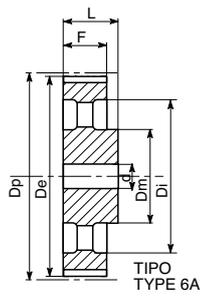
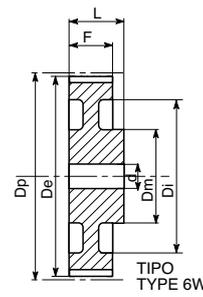
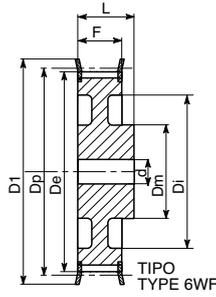
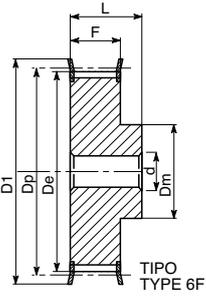

## L 100 - 3/8" (9,525 mm)

Caratteristiche Features Merkmale Características Características	Codice Code symbol Fabriknummer Code symbole Numero de fabrica	Nostro codice Our code Unser kode Notre code Nuestro codigo	Tipo Type Typ Type Tipo	Tipo flangia Flanges type Bordscheiben Typ Type flasques Tipo tapetas	N. denti N. of teeth Zahnezahl N. bre de dents Cantidad de dientes	Dp	De	Df	Dm	Di	F	L	Foro stock Stock bore Vor bohrung Alesage en stock Agujero de stock	Peso Weight / Gewicht Poids / Peso Kg			
Acciaio / Steel / Stahl Acier / Acero	con flangia / with flanges mit Flanges / avec flasques / con tapetas	10L100	L100010	6F	F13	10	30,32	29,56	37	20	—	31,8	45	8	0,15		
		11L100	L100011	6F	F14	11	33,35	32,59	38	22	—	31,8	45	8	0,20		
		12L100	L100012	6F	F16	12	36,38	35,62	43	24	—	31,8	45	8	0,26		
		13L100	L100013	6F	F17	13	39,41	38,65	44	28	—	31,8	45	8	0,30		
		14L100	L100014	6F	F18	14	42,45	41,68	48	28	—	31,8	45	11	0,34		
		15L100	L100015	6F	F19	15	45,48	44,72	51	34	—	31,8	45	11	0,45		
		16L100	L100016	6F	F20	16	48,51	47,75	54	36	—	31,8	45	11	0,52		
		17L100	L100017	6F	F21	17	51,54	50,78	57	36	—	31,8	45	11	0,53		
		18L100	L100018	6F	F22	18	54,57	53,81	60	40	—	31,8	45	11	0,62		
		19L100	L100019	6F	F24	19	57,61	56,84	64	40	—	31,8	45	11	0,66		
		20L100	L100020	6F	F25	20	60,64	59,88	66	40	—	31,8	45	11	0,72		
		21L100	L100021	6F	F26	21	63,67	62,91	70	45	—	31,8	45	11	0,77		
		22L100	L100022	6F	F27	22	66,70	65,94	75	45	—	31,8	45	11	0,88		
		23L100	L100023	6F	F28	23	69,73	68,97	79	55	—	31,8	45	11	1,12		
		24L100	L100024	6F	F28	24	72,77	72,00	79	55	—	31,8	45	11	1,13		
		25L100	L100025	6F	F29	25	75,80	75,04	83	58	—	31,8	45	11	1,18		
		26L100	L100026	6F	F30	26	78,83	78,07	87	58	—	31,8	45	11	1,24		
		27L100	L100027	6F	F30	27	81,86	81,10	87	58	—	31,8	45	11	1,35		
		28L100	L100028	6F	F31	28	84,89	84,13	91	58	—	31,8	45	11	1,42		
		29L100	L100029	6F	F32	29	87,93	87,16	93	58	—	31,8	45	11	1,50		
		30L100	L100030	6F	F33	30	90,96	90,20	97	70	—	31,8	45	11	1,61		
		32L100	L100032	6F	F34	32	97,02	96,26	102	70	—	31,8	45	11	1,84		
		33L100	L100033	6F	F35	33	100,05	99,29	106	70	—	31,8	45	11	1,95		
		34L100	L100034	6F	F36	34	103,08	102,32	112	70	—	31,8	45	11	2,10		
		35L100	L100035	6F	F37	35	106,12	105,35	112	70	—	31,8	45	11	2,23		
		36L100	L100036	6F	F37	36	109,15	108,39	115	70	—	31,8	45	11	2,32		
		40L100	L100040	6WF	F40	40	121,28	120,51	128	70	100	31,8	45	11	2,80		
		41L100	L100041	6WF	F41	41	124,31	123,55	131	70	103	31,8	45	11	2,95		
		42L100	L100042	6WF	F42	42	127,34	126,58	135	70	106	31,8	45	11	3,10		
		44L100	L100044	6WF	F45	44	133,40	132,62	142	70	112	31,8	45	11	3,36		
		45L100	L100045	6WF	F45	45	136,44	135,67	142	70	115	31,8	45	11	3,45		
		47L100	L100047	6WF	F48	47	142,50	141,74	150	70	121	31,8	45	11	3,65		
		48L100	L100048	6WF	F48	48	145,53	144,77	150	70	124	31,8	45	11	3,86		
		Ghisa / Cast iron / Grauguss Fonte / Hierro fundido	senza flangia / without flanges ohne Flanschen / sans flasques sin tapetas	49L100	L100049	6W	F49	49	148,56	147,80	—	70	127	31,8	45	14	2,86
				50L100	L100050	6W	F50	50	151,60	150,83	—	70	130	31,8	45	14	2,50
				52L100	L100052	6W	F52	52	157,66	156,90	—	70	136	31,8	45	14	2,70
56L100	L100056			6W	F56	56	169,79	169,02	—	70	149	31,8	45	14	2,91		
57L100	L100057			6W	F57	57	172,82	172,06	—	70	152	31,8	45	14	3,10		
60L100	L100060			6W	F60	60	181,91	181,15	—	75	160	31,8	50	14	3,55		
65L100	L100065			6A	F65	65	197,07	196,31	—	75	176	31,8	50	14	4,00		
66L100	L100066			6A	F66	66	200,11	199,34	—	75	179	31,8	50	14	4,15		
72L100	L100072			6A	F72	72	218,30	217,53	—	75	197	31,8	50	14	5,00		
84L100	L100084			6A	F84	84	254,68	253,92	—	75	233	31,8	50	14	6,30		
90L100	L100090			6A	F90	90	272,87	272,11	—	75	252	31,8	50	14	7,50		
96L100	L100096			6A	F96	96	291,06	290,30	—	75	269	31,8	50	14	8,20		
120L100	L100120			6A	F120	120	363,83	363,07	—	75	342	31,8	50	14	11,50		

## H 075 - 1/2" (12,75 mm)

Caratteristiche Features Merkmale Características Características	Codice Code symbol Fabriknummer Code symbole Numero de fabrica	Nostro codice Our code Unser kode Notre code Nuestro codigo	Tipo Type Typ Type Tipo	Tipo flangia Flanges type Bordscheiben Typ Type flasques Tipo tapetas	N. denti N. of teeth Zahnezahl N. bre de dents Cantidad de dientes	Dp	De	Df	Dm	Di	F	L	Foro stock Stock bore Vor bohrung Alesage en stock Agujero de stock	Peso Weight / Gewicht Poids / Peso Kg			
Acciaio / Steel / Stahl Acier / Acero	con flangia / with flanges mit Flanges / avec flasques / con tapetas	14H075	H75014	6F	F24	14	56,60	55,22	64	40	—	26,4	40	8	0,59		
		15H075	H75015	6F	F25	15	60,64	59,27	66	45	—	26,4	40	8	0,65		
		16H075	H75016	6F	F26	16	64,68	63,31	70	45	—	26,4	40	8	0,70		
		17H075	H75017	6F	F27	17	68,72	67,35	75	45	—	26,4	40	8	0,73		
		18H075	H75018	6F	F28	18	72,77	71,39	79	55	—	26,4	40	11	0,91		
		19H075	H75019	6F	F29	19	76,81	75,44	83	60	—	26,4	40	11	1,08		
		20H075	H75020	6F	F30	20	80,85	79,48	87	62	—	26,4	40	11	1,18		
		21H075	H75021	6F	F31	21	84,89	83,52	91	65	—	26,4	40	11	1,30		
		22H075	H75022	6F	F32	22	88,94	87,56	93	68	—	26,4	40	11	1,42		
		23H075	H75023	6F	F33	23	92,98	91,61	97	72	—	26,4	40	11	1,67		
		24H075	H75024	6F	F34	24	97,02	95,65	102	72	—	26,4	40	11	1,71		
		25H075	H75025	6F	F35	25	101,06	99,69	106	72	—	26,4	40	11	1,87		
		26H075	H75026	6F	F36	26	105,11	103,73	112	80	—	26,4	40	11	2,00		
		27H075	H75027	6F	F37	27	109,15	107,78	115	80	—	26,4	40	11	2,10		
		28H075	H75028	6F	F38	28	113,19	111,82	120	80	—	26,4	40	11	2,26		
		29H075	H75029	6F	F39	29	117,23	115,86	123	80	—	26,4	40	11	2,49		
		30H075	H75030	6F	F40	30	121,28	119,90	128	80	—	26,4	40	11	2,70		
		32H075	H75032	6F	F42	32	129,36	127,99	135	80	—	26,4	40	11	2,85		
		33H075	H75033	6F	F44	33	133,40	132,03	140	80	—	26,4	40	11	3,10		
		34H075	H75034	6F	F45	34	137,45	136,07	142	80	—	26,4	40	11	3,30		
		35H075	H75035	6F	F48	35	141,49	140,12	150	80	—	26,4	40	11	3,50		
		36H075	H75036	6WF	F48	36	145,53	144,16	150	80	118	26,4	40	11	3,65		
		38H075	H75038	6WF	F50	38	153,62	152,24	158	80	126	26,4	40	11	3,90		
		40H075	H75040	6WF	F52	40	161,70	160,33	168	80	134	26,4	40	11	4,23		
		42H075	H75042	6WF	F53	42	169,79	168,41	175	80	140	26,4	40	11	4,80		
		44H075	H75044	6WF	F55	44	177,87	176,50	184	80	150	26,4	40	14	5,20		
		45H075	H75045	6WF	F57	45	181,91	180,54	192	80	154	26,4	40	14	5,45		
		48H075	H75048	6WF	F59	48	194,04	192,67	200	90	166	26,4	45	14	4,30		
		Ghisa / Cast iron / Grauguss Fonte / Hierro fundido	senza flangia / without flanges ohne Flanschen / sans flasques / sin tapetas	49H075	H75049	6W	F49	49	198,08	196,71	—	90	170	26,4	45	14	4,50
				50H075	H75050	6W	F50	50	202,13	200,75	—	90	174	26,4	45	14	4,66

# Pulegge per cinghie dentate / Timing belt pulleys Zahnriemenscheiben / Poulies pour courroies dentées / Poleas para correas dentadas



## H 100 - 1/2" (12,75 mm)

Caratteristiche Features Merkmale Características Características	Codice Code symbol Fabriknummer Code symbole Numero de fabrica	Nostro codice Our code Unser kode Notre code Nuestro codigo	Tipo Type Typ Type Tipo	Tipo flangia Flanges type Bordscheiben Typ Type flasques Tipo tapetas	N. denti N. of teeth Zahnezahl N. bre de dents Cantidad de dientes	Dp	De	Df	Dm	Di	F	L	Foro stock Stock bore Vor bohrung Alesage en stock Agujero de stock	Peso Weight / Gewicht Poids / Peso Kg	
Acciaio / Steel / Stahl Acier / Acero	con flangia / with flanges mit Flanges / avec flasques / con tapetas	14H100	H100014	6F	F24	14	56,60	55,22	64	45	—	31,8	45	11	0,67
		15H100	H100015	6F	F25	15	60,64	59,27	66	45	—	31,8	45	11	0,77
		16H100	H100016	6F	F26	16	64,68	63,31	70	45	—	31,8	45	11	0,88
		17H100	H100017	6F	F27	17	68,72	67,35	75	45	—	31,8	45	11	0,88
		18H100	H100018	6F	F28	18	72,77	71,39	79	55	—	31,8	45	14	1,06
		19H100	H100019	6F	F29	19	76,81	75,44	83	60	—	31,8	45	14	1,23
		20H100	H100020	6F	F30	20	80,85	79,48	87	62	—	31,8	45	14	1,33
		21H100	H100021	6F	F31	21	84,89	83,52	91	65	—	31,8	45	14	1,43
		22H100	H100022	6F	F32	22	88,94	87,56	93	68	—	31,8	45	14	1,63
		23H100	H100023	6F	F33	23	92,98	91,61	97	72	—	31,8	45	14	1,85
		24H100	H100024	6F	F34	24	97,02	95,65	102	72	—	31,8	45	14	1,93
		25H100	H100025	6F	F35	25	101,06	99,69	106	72	—	31,8	45	14	2,07
		26H100	H100026	6F	F36	26	105,11	103,73	112	80	—	31,8	45	14	2,30
		27H100	H100027	6F	F37	27	109,15	107,78	115	80	—	31,8	45	14	2,40
		28H100	H100028	6F	F38	28	113,19	111,82	120	80	—	31,8	45	14	2,53
		29H100	H100029	6F	F39	29	117,23	115,86	123	80	—	31,8	45	14	2,70
		30H100	H100030	6F	F40	30	121,28	119,90	128	80	—	31,8	45	14	2,93
		32H100	H100032	6F	F42	32	129,36	127,99	135	80	—	31,8	45	14	3,06
		33H100	H100033	6F	F44	33	133,40	132,03	140	80	—	31,8	45	14	3,40
		34H100	H100034	6F	F45	34	137,45	136,07	142	80	—	31,8	45	14	3,57
		35H100	H100035	6F	F48	35	141,49	140,12	150	80	—	31,8	45	14	3,80
		36H100	H100036	6WF	F48	36	145,53	144,16	150	80	118	31,8	45	14	3,92
		38H100	H100038	6WF	F50	38	153,62	152,24	158	80	123	31,8	45	14	4,40
		40H100	H100040	6WF	F52	40	161,70	160,33	168	80	134	31,8	45	14	4,95
		42H100	H100042	6WF	F53	42	169,79	168,41	175	80	140	31,8	45	14	5,60
		44H100	H100044	6WF	F55	44	177,87	176,50	184	80	150	31,8	50	14	6,20
		45H100	H100045	6WF	F57	45	181,91	180,54	192	80	154	31,8	50	14	6,45
		48H100	H100048	6WF	F59	48	194,04	192,67	200	90	166	31,8	50	14	5,30
		49H100	H100049	6W		49	198,08	196,71	—	90	170	31,8	50	19	5,40
		50H100	H100050	6W		50	202,13	200,75	—	90	174	31,8	50	19	5,50
		52H100	H100052	6W		52	210,21	208,84	—	90	182	31,8	50	19	5,80
		58H100	H100058	6A		58	234,47	233,09	—	90	207	31,8	50	19	6,20
		60H100	H100060	6A		60	242,55	241,18	—	90	215	31,8	50	19	7,50
		70H100	H100070	6A		70	282,98	281,61	—	100	255	31,8	55	19	8,20
		72H100	H100072	6A		72	291,06	289,69	—	100	263	31,8	55	19	9,00
82H100	H100082	6A		82	331,49	330,12	—	100	304	31,8	55	19	9,20		
84H100	H100084	6A		84	339,57	338,20	—	100	312	31,8	55	19	10,00		
94H100	H100094	6A		94	380,00	378,63	—	120	352	31,8	60	19	13,00		
96H100	H100096	6A		96	388,08	386,71	—	120	360	31,8	60	19	13,80		
106H100	H100106	6A		106	428,51	427,14	—	120	401	31,8	60	19	15,50		
116H100	H100116	6A		116	468,93	467,56	—	120	441	31,8	60	19	18,00		
118H100	H100118	6A		118	477,02	475,65	—	120	449	31,8	60	19	20,00		
120H100	H100120	6A		120	485,10	483,73	—	120	458	31,8	60	19	22,00		
150H100	H100150	6A		150	606,38	605,01	—	120	579	31,8	60	19	25,00		
152H100	H100152	6A		152	614,47	613,09	—	120	587	31,8	60	19	26,00		
154H100	H100154	6A		154	622,55	621,18	—	120	595	31,8	60	19	27,00		
156H100	H100156	6A		156	630,64	629,26	—	120	603	31,8	60	19	28,00		

## H 150 - 1/2" (12,75 mm)

Caratteristiche Features Merkmale Características Características	Codice Code symbol Fabriknummer Code symbole Numero de fabrica	Nostro codice Our code Unser kode Notre code Nuestro codigo	Tipo Type Typ Type Tipo	Tipo flangia Flanges type Bordscheiben Typ Type flasques Tipo tapetas	N. denti N. of teeth Zahnezahl N. bre de dents Cantidad de dientes	Dp	De	Df	Dm	Di	F	L	Foro stock Stock bore Vor bohrung Alesage en stock Agujero de stock	Peso Weight / Gewicht Poids / Peso Kg	
Acciaio / Steel / Stahl Acier / Acero	con flangia / with flanges mit Flanges / avec flasques / con tapetas	14H150	H150014	6F	F24	14	56,60	55,22	64	42	—	46,0	58	11	0,91
		15H150	H150015	6F	F25	15	60,64	59,27	66	45	—	46,0	58	11	0,99
		16H150	H150016	6F	F26	16	64,68	63,31	70	45	—	46,0	58	11	1,08
		17H150	H150017	6F	F27	17	68,72	67,35	75	45	—	46,0	58	11	1,15
		18H150	H150018	6F	F28	18	72,77	71,39	79	55	—	46,0	58	14	1,45
		19H150	H150019	6F	F29	19	76,81	75,44	83	60	—	46,0	58	14	1,55
		20H150	H150020	6F	F30	20	80,85	79,48	87	62	—	46,0	58	14	1,66
		21H150	H150021	6F	F31	21	84,89	83,52	91	65	—	46,0	58	14	1,87
		22H150	H150022	6F	F32	22	88,94	87,56	93	68	—	46,0	58	14	2,07
		23H150	H150023	6F	F33	23	92,98	91,61	97	72	—	46,0	58	14	2,28
		24H150	H150024	6F	F34	24	97,02	95,65	102	72	—	46,0	58	14	2,50
		25H150	H150025	6F	F35	25	101,06	99,69	106	72	—	46,0	58	14	2,71
		26H150	H150026	6F	F36	26	105,11	103,73	112	80	—	46,0	58	14	2,99
		27H150	H150027	6F	F37	27	109,15	107,78	115	80	—	46,0	58	14	3,15
		28H150	H150028	6F	F38	28	113,19	111,82	120	80	—	46,0	58	14	3,39
		29H150	H150029	6F	F39	29	117,23	115,86	123	80	—	46,0	58	14	3,57
		30H150	H150030	6F	F40	30	121,28	119,90	128	80	—	46,0	58	14	3,86
		32H150	H150032	6F	F42	32	129,36	127,99	135	80	—	46,0	58	14	4,37
		33H150	H150033	6F	F44	33	133,40	132,03	140	80	—	46,0	58	14	4,66
		34H150	H150034	6F	F45	34	137,45	136,07	142	80	—	46,0	58	14	4,98
		35H150	H150035	6F	F48	35	141,49	140,12	150	80	—	46,0	58	14	5,30
		36H150	H150036	6WF	F48	36	145,53	144,16	150	80	118	46,0	58	14	5,50
		38H150	H150038	6WF	F50	38	153,62	152,24	158	80	126	46,0	58	14	6,10
		40H150	H150040	6WF	F52	40	161,70	160,33	168	80	134	46,0	58	14	6,80
		42H150	H150042	6WF	F53	42	169,79	168,41	175	80	140	46,0	58	19	7,60
		44H150	H150044	6WF	F55	44	177,87	176,50	184	80	150	46,0	58	19	8,50
		45H150	H150045	6WF	F57	45	181,91	180,54	192	80	154	46,0	58	19	9,00
		48H150	H150048	6WF	F59	48	194,04	192,67	200	90	166	46,0	65	19	6,70
		49H150	H150049	6W		49	198,08	196,71	—	90	170	46,0	65	19	7,00
		50H150	H150050	6W		50	202,13	200,75	—	90	174	46,0	65	19	7,10
		52H150	H150052	6W		52	210,21	208,84	—	90	182	46,0	65	19	7,30
		58H150	H150058	6A		58	234,47	233,09	—	90	207	46,0	65	19	8,10
		60H150	H150060	6A		60	242,55	241,18	—	90	215	46,0	65	19	9,00
		70H150	H150070	6A		70	282,98	281,61	—	100	255	46,0	65	24	10,50
		72H150	H150072	6A		72	291,06	289,69	—	100	263	46,0	65	24	11,00
82H150	H150082	6A		82	331,49	330,12	—	100	304	46,0	65	24	12,00		
84H150	H150084	6A		84	339,57	338,20	—	100	312	46,0	65	24	13,00		
94H150	H150094	6A		94	380,00	378,63	—	120	352	46,0	65	24	16,00		
96H150	H150096	6A		96	388,08	386,71	—	120	360	46,0	65	24	17,00		
106H150	H150106	6A		106	428,51	427,14	—	120	401	46,0	65	24	19,50		
116H150	H150116	6A		116	468,93	467,56	—	120	441	46,0	65	24	22,00		
118H150	H150118	6A		118	477,02	475,65	—	120	449	46,0	65	24	23,50		
120H150	H150120	6A		120	485,10	483,73	—	120	458	46,0	65	24	25,00		
150H150	H150150	6A		150	606,38	605,01	—	120	579	46,0	65	24	31,50		
15															

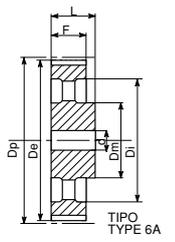
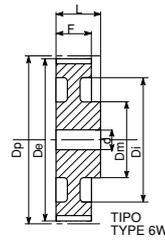
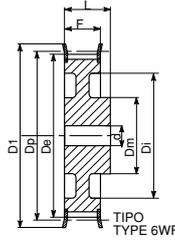
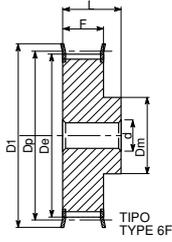

### H 200 - 1/2" (12,75 mm)

Caratteristiche Features Merkmal Características	Codice Code symbol Fabriknummer Code symbole Numero de fabrica	Nostro codice Our code Unser kode Notre code Nuestro codigo	Tipo Type Typ Type Tipo	Tipo flangia Flanges type Bordscheiben Typ Type flasques Tipo tapetas	N. denti N. of teeth Zahnezahl N. bre de dents Cantidad de dientes	Dp	De	Df	Dm	Di	F	L	Foro stock Stock bore Vor bohrung Alesage en stock Agujero de stock	Peso Weight / Gewicht Poids / Peso Kg			
Acciaio / Steel / Stahl Acier / Acero	con flangia / with flanges mit Flanges / avec flasques / con tapetas	14H200	H200014	6F	F24	14	56,60	55,22	64	42	—	58,7	70	11	1,13		
		15H200	H200015	6F	F25	15	60,64	59,27	66	45	—	58,7	70	11	1,21		
		16H200	H200016	6F	F26	16	64,68	63,31	70	45	—	58,7	70	11	1,30		
		17H200	H200017	6F	F27	17	68,72	67,35	75	45	—	58,7	70	11	1,45		
		18H200	H200018	6F	F28	18	72,77	71,39	79	55	—	58,7	70	14	1,65		
		19H200	H200019	6F	F29	19	76,81	75,44	83	60	—	58,7	70	14	1,90		
		20H200	H200020	6F	F30	20	80,85	79,48	87	62	—	58,7	70	14	2,11		
		21H200	H200021	6F	F31	21	84,89	83,52	91	65	—	58,7	70	14	2,23		
		22H200	H200022	6F	F32	22	88,94	87,56	93	68	—	58,7	70	14	2,45		
		23H200	H200023	6F	F33	23	92,98	91,61	97	72	—	58,7	70	14	2,71		
		24H200	H200024	6F	F34	24	97,02	95,65	102	72	—	58,7	70	14	2,97		
		25H200	H200025	6F	F35	25	101,06	99,69	106	72	—	58,7	70	14	3,32		
		26H200	H200026	6F	F36	26	105,11	103,73	112	80	—	58,7	70	14	3,61		
		27H200	H200027	6F	F37	27	109,15	107,78	115	80	—	58,7	70	14	3,90		
		28H200	H200028	6F	F38	28	113,19	111,82	120	80	—	58,7	70	14	4,10		
		29H200	H200029	6F	F39	29	117,23	115,86	123	80	—	58,7	70	14	4,42		
		30H200	H200030	6F	F40	30	121,28	119,90	128	80	—	58,7	70	14	4,74		
		32H200	H200032	6F	F42	32	129,36	127,99	135	80	—	58,7	70	14	5,60		
		33H200	H200033	6F	F44	33	133,40	132,03	140	80	—	58,7	70	14	5,90		
		34H200	H200034	6F	F45	34	137,45	136,07	142	80	—	58,7	70	14	6,20		
		35H200	H200035	6F	F48	35	141,49	140,12	150	80	—	58,7	70	14	6,60		
		36H200	H200036	6WF	F48	36	145,53	144,16	150	80	118	58,7	70	14	7,10		
		38H200	H200038	6WF	F50	38	153,62	152,24	158	80	126	58,7	70	14	8,40		
		40H200	H200040	6WF	F52	40	161,70	160,33	168	80	134	58,7	70	14	7,80		
		42H200	H200042	6WF	F53	42	169,79	168,41	180	80	140	58,7	70	19	9,70		
		44H200	H200044	6WF	F55	44	177,87	176,50	184	80	150	58,7	70	19	10,50		
		45H200	H200045	6WF	F57	45	181,91	180,54	192	80	154	58,7	70	19	11,30		
		48H200	H200048	6WF	F59	48	194,04	192,67	200	90	166	58,7	75	24	8,60		
		Ghisa / Cast iron / Grauguss Fonte / Hierro fundido	senza flangia / without flanges ohne Flanschen / sans flasques / sin tapetas	49H200	H200049	6W		49	198,08	196,71	—	90	170	58,7	75	24	7,60
				50H200	H200050	6W		50	202,13	200,75	—	90	174	58,7	75	24	8,30
				52H200	H200052	6W		52	210,21	208,84	—	90	182	58,7	75	24	8,50
				58H200	H200058	6A		58	234,47	233,09	—	90	207	85,7	75	24	10,00
				60H200	H200060	6A		60	242,55	241,18	—	90	215	85,7	75	24	11,00
				70H200	H200070	6A		70	282,98	281,61	—	100	255	85,7	75	28	12,50
				72H200	H200072	6A		72	291,06	289,69	—	100	263	85,7	75	28	14,00
82H200	H200082			6A		82	331,49	330,12	—	100	304	85,7	75	28	13,50		
84H200	H200084			6A		84	339,57	338,20	—	100	312	85,7	75	28	15,00		
94H200	H200094			6A		94	380,00	378,63	—	120	352	85,7	75	28	18,90		
96H200	H200096			6A		96	388,08	386,71	—	120	360	85,7	75	28	20,30		
106H200	H200106			6A		106	428,51	427,14	—	120	401	85,7	75	28	22,50		
116H200	H200116			6A		116	468,93	467,56	—	120	441	85,7	75	28	24,70		
118H200	H200118			6A		118	477,02	475,65	—	120	449	85,7	75	28	26,00		
120H200	H200120			6A		120	485,10	483,73	—	120	458	85,7	75	28	28,00		
150H200	H200150			6A		150	606,38	605,01	—	120	579	85,7	75	28	32,50		
152H200	H200152			6A		152	614,47	613,09	—	120	587	85,7	75	28	35,00		
154H200	H200154			6A		154	622,55	621,18	—	120	595	85,7	75	28	38,00		
156H200	H200156			6A		156	630,64	629,26	—	120	603	85,7	75	28	41,00		

### H 300 - 1/2" (12,75 mm)

Caratteristiche Features Merkmal Características	Codice Code symbol Fabriknummer Code symbole Numero de fabrica	Nostro codice Our code Unser kode Notre code Nuestro codigo	Tipo Type Typ Type Tipo	Tipo flangia Flanges type Bordscheiben Typ Type flasques Tipo tapetas	N. denti N. of teeth Zahnezahl N. bre de dents Cantidad de dientes	Dp	De	Df	Dm	Di	F	L	Foro stock Stock bore Vor bohrung Alesage en stock Agujero de stock	Peso Weight / Gewicht Poids / Peso Kg			
Acciaio / Steel / Stahl Acier / Acero	con flangia / with flanges mit Flanges / avec flasques / con tapetas	14H300	H300014	6F	F24	14	56,60	55,22	64	42	—	85,7	100	11	1,35		
		15H300	H300015	6F	F25	15	60,64	59,27	66	45	—	85,7	100	11	1,55		
		16H300	H300016	6F	F26	16	64,68	63,31	70	45	—	85,7	100	11	1,80		
		17H300	H300017	6F	F27	17	68,72	67,35	75	45	—	85,7	100	11	2,10		
		18H300	H300018	6F	F28	18	72,77	71,39	79	55	—	85,7	100	19	2,38		
		19H300	H300019	6F	F29	19	76,81	75,44	83	60	—	85,7	100	19	2,64		
		20H300	H300020	6F	F30	20	80,85	79,48	87	62	—	85,7	100	19	3,10		
		21H300	H300021	6F	F31	21	84,89	83,52	91	65	—	85,7	100	19	3,32		
		22H300	H300022	6F	F32	22	88,94	87,56	93	68	—	85,7	100	19	3,67		
		23H300	H300023	6F	F33	23	92,98	91,61	97	72	—	85,7	100	19	4,00		
		24H300	H300024	6F	F34	24	97,02	95,65	102	72	—	85,7	100	19	4,40		
		25H300	H300025	6F	F35	25	101,06	99,69	106	72	—	85,7	100	19	4,79		
		26H300	H300026	6F	F36	26	105,11	103,73	112	80	—	85,7	100	19	5,20		
		27H300	H300027	6F	F37	27	109,15	107,78	115	80	—	85,7	100	19	5,60		
		28H300	H300028	6F	F38	28	113,19	111,82	120	80	—	85,7	100	19	5,60		
		29H300	H300029	6F	F39	29	117,23	115,86	123	80	—	85,7	100	19	6,00		
		30H300	H300030	6F	F40	30	121,28	119,90	128	80	—	85,7	100	19	7,00		
		32H300	H300032	6F	F42	32	129,36	127,99	135	80	—	85,7	100	19	7,80		
		33H300	H300033	6F	F44	33	133,40	132,03	140	80	—	85,7	100	19	8,70		
		34H300	H300034	6F	F45	34	137,45	136,07	142	80	—	85,7	100	19	9,70		
		35H300	H300035	6F	F48	35	141,49	140,12	150	80	—	85,7	100	19	9,80		
		36H300	H300036	6WF	F48	36	145,53	144,16	150	80	118	85,7	100	19	9,90		
		38H300	H300038	6WF	F50	38	153,62	152,24	158	80	126	85,7	100	19	11,00		
		40H300	H300040	6WF	F52	40	161,70	160,33	168	80	134	85,7	100	19	12,20		
		42H300	H300042	6WF	F53	42	169,79	168,41	180	80	140	85,7	100	24	13,80		
		44H300	H300044	6WF	F55	44	177,87	176,50	184	80	150	85,7	100	24	15,00		
		45H300	H300045	6WF	F57	45	181,91	180,54	192	80	154	85,7	100	24	15,20		
		48H300	H300048	6WF	F59	48	194,04	192,67	200	90	166	85,7	100	24	11,40		
		Ghisa / Cast iron / Grauguss Fonte / Hierro fundido	senza flangia / without flanges ohne Flanschen / sans flasques / sin tapetas	49H300	H300049	6W		49	198,08	196,71	—	90	170	85,7	100	24	9,40
				50H300	H300050	6W		50	202,13	200,75	—	90	174	85,7	100	24	10,60
				52H300	H300052	6W		52	210,21	208,84	—	90	182	85,7	100	24	11,80
				58H300	H300058	6A		58	234,47	233,09	—	90	207	85,7	100	24	12,20
				60H300	H300060	6A		60	242,55	241,18	—	90	215	85,7	100	24	13,00
				70H300	H300070	6A		70	282,98	281,61	—	100	255	85,7	100	28	16,50
				72H300	H300072	6A		72	291,06	289,69	—	100	263	85,7	100	28	19,00
82H300	H300082			6A		82	331,49	330,12	—	100	304	85,7	100	28	18,00		
84H300	H300084			6A		84	339,57	338,20	—	100	312	85,7	100	28	20,00		
94H300	H300094			6A		94	380,00	378,63	—	120	352	85,7	100	28	25,50		
96H300	H300096			6A		96	388,08	386,71	—	120	360	85,7	100	28	27,00		
106H300	H300106			6A		106	428,51	427,14	—	120	401	85,7	100	28	27,90		
116H300	H300116			6A		116	468,93	467,56	—	120	441	85,7	100	28	28,50		
118H300	H300118			6A		118	477,02	475,65	—	120	449	85,7	100	28	31,00		
120H300	H300120			6A		120	48										



# Pulegge per cinghie dentate / Timing belt pulleys Zahnriemenscheiben / Poulies pour courroies dentées / Poleas para correas dentadas



## XH 200 - 7/8" (22,225 mm)

Caratteristiche Features Merkmale Características	Codice Code symbol Fabriknummer Code symbole Numero de fabrica	Nostro codice Our code Unser kode Notre code Nuestro codigo	Tipo Type Typ Type Tipo	Tipo flangia Flanges type Bordscheiben Typ Type flasques Tipo tapetas	N. denti N. of teeth Zahnezahl N. bre de dents Cantidad de dientes	Dp	De	Df	Dm	Di	F	L	Foro stock Stock bore Vor bohrung Alesage en stock Agujero de stock	Peso Weight / Gewicht Poids / Peso Kg			
Acciaio / Steel / Stahl Acier / Acero	con flangia / with flanges mit Flanges / avec flasques / con tapetas	18XH200	XH20018	6F	F44	18	127,34	124,55	140	100	—	65	80	24	5,90		
		19XH200	XH20019	6F	F46	19	134,41	131,62	146	100	—	65	80	24	6,50		
		20XH200	XH20020	6F	F50	20	141,49	138,69	155	100	—	65	80	24	7,20		
		21XH200	XH20021	6F	F51	21	148,56	145,77	160	110	—	65	80	24	7,90		
		22XH200	XH20022	6F	F52	22	155,64	152,84	168	110	—	65	80	24	8,70		
		24XH200	XH20024	6F	F81	24	169,79	166,99	184	120	—	65	80	24	10,60		
		25XH200	XH20025	6F	F56	25	176,86	174,07	188	120	—	65	80	24	11,40		
		26XH200	XH20026	6F	F59	26	183,94	181,14	200	120	—	65	80	24	12,20		
		27XH200	XH20027	6F	F59	27	191,01	188,22	200	120	—	65	80	24	13,50		
		28XH200	XH20028	6F	F61	28	198,08	195,29	212	150	—	65	80	24	14,80		
		30XH200	XH20030	6F	F62	30	212,23	209,44	226	150	—	65	80	24	16,60		
		32XH200	XH20032	6WF	F64	32	226,38	223,59	240	150	184	65	80	24	17,90		
		34XH200	XH20034	6WF	F66	34	240,53	237,74	256	150	198	65	80	24	18,20		
		38XH200	XH20038	6WF	F69	38	268,83	266,03	286	150	227	65	100	28	19,00		
		40XH200	XH20040	6WF	F70	40	282,98	280,18	296	150	241	65	100	28	22,10		
		Ghisa / Cast iron / Grauguss Fonte / Hierro fundido	senza flangia / without flanges ohne Flanschen / sans flasques sin tapetas	46XH200	XH20046	6W		46	325,42	322,63	—	150	283	65	100	28	26,00
				48XH200	XH20048	6W		48	339,57	336,78	—	150	297	65	100	28	27,60
				50XH200	XH20050	6W		50	410,32	407,52	—	150	368	65	100	28	27,60
				60XH200	XH20060	6W		60	424,47	421,67	—	150	382	65	100	28	22,10
				70XH200	XH20070	6A		70	495,21	492,42	—	190	453	65	100	28	39,00
72XH200	XH20072			6A		72	509,36	506,56	—	190	467	65	100	28	42,00		
78XH200	XH20078			6A		78	551,81	549,01	—	190	510	65	100	28	48,00		
80XH200	XH20080			6A		80	565,95	563,16	—	190	524	65	100	28	51,00		
82XH200	XH20082			6A		82	580,10	577,31	—	190	538	65	100	28	54,00		
84XH200	XH20084			6A		84	594,25	591,46	—	190	552	65	100	28	57,00		
94XH200	XH20094			6A		94	665,00	662,20	—	190	623	65	100	28	64,00		
96XH200	XH20096			6A		96	679,15	676,35	—	190	637	65	100	28	67,00		
118XH200	XH20118			6A		118	834,78	831,99	—	190	792	65	100	28	88,00		
120XH200	XH20120			6A		120	848,93	846,14	—	190	806	65	100	28	90,00		

## XH 300 - 7/8" (22,225 mm)

Caratteristiche Features Merkmale Características	Codice Code symbol Fabriknummer Code symbole Numero de fabrica	Nostro codice Our code Unser kode Notre code Nuestro codigo	Tipo Type Typ Type Tipo	Tipo flangia Flanges type Bordscheiben Typ Type flasques Tipo tapetas	N. denti N. of teeth Zahnezahl N. bre de dents Cantidad de dientes	Dp	De	Df	Dm	Di	F	L	Foro stock Stock bore Vor bohrung Alesage en stock Agujero de stock	Peso Weight / Gewicht Poids / Peso Kg			
Acciaio / Steel / Stahl Acier / Acero	con flangia / with flanges mit Flanges / avec flasques / con tapetas	18XH300	XH30018	6F	F44	18	127,34	124,55	140	100	—	90,5	110	28	8,90		
		19XH300	XH30019	6F	F46	19	134,41	131,62	146	100	—	90,5	110	28	9,20		
		20XH300	XH30020	6F	F50	20	141,49	138,69	155	100	—	90,5	110	28	9,50		
		21XH300	XH30021	6F	F51	21	148,56	145,77	160	110	—	90,5	110	28	10,80		
		22XH300	XH30022	6F	F52	22	155,64	152,84	168	110	—	90,5	110	28	12,10		
		24XH300	XH30024	6F	F81	24	169,79	166,99	184	120	—	90,5	110	28	14,10		
		25XH300	XH30025	6F	F56	25	176,86	174,07	188	120	—	90,5	110	28	15,40		
		26XH300	XH30026	6F	F59	26	183,94	181,14	200	120	—	90,5	110	28	16,70		
		27XH300	XH30027	6F	F59	27	191,01	188,22	200	120	—	90,5	110	28	18,40		
		28XH300	XH30028	6F	F61	28	198,08	195,29	212	150	—	90,5	110	28	20,20		
		30XH300	XH30030	6F	F62	30	212,23	209,44	226	150	—	90,5	110	28	23,80		
		32XH300	XH30032	6WF	F64	32	226,38	223,59	240	150	—	90,5	110	28	26,60		
		34XH300	XH30034	6WF	F66	34	240,53	237,74	256	150	198	90,5	110	28	29,40		
		38XH300	XH30038	6WF	F69	38	268,83	266,03	286	175	227	90,5	120	32	32,00		
		40XH300	XH30040	6WF	F70	40	282,98	280,18	296	175	241	90,5	120	32	37,50		
		Ghisa / Cast iron / Grauguss Fonte / Hierro fundido	senza flangia / without flanges ohne Flanschen / sans flasques sin tapetas	46XH300	XH30046	6W		46	325,42	322,63	—	175	283	90,5	120	32	32,50
				48XH300	XH30048	6W		48	339,57	336,78	—	175	297	90,5	120	32	34,00
				50XH300	XH30050	6W		50	410,32	407,52	—	175	368	90,5	120	32	37,00
				60XH300	XH30060	6W		60	424,47	421,67	—	175	382	90,5	120	32	39,00
				70XH300	XH30070	6A		70	495,21	492,42	—	175	453	90,5	120	32	53,00
72XH300	XH30072			6A		72	509,36	506,56	—	175	467	90,5	120	32	55,00		
78XH300	XH30078			6A		78	551,81	549,01	—	175	510	90,5	120	32	62,00		
80XH300	XH30080			6A		80	565,95	563,16	—	175	524	90,5	120	32	64,00		
82XH300	XH30082			6A		82	580,10	577,31	—	175	538	90,5	120	32	66,00		
84XH300	XH30084			6A		84	594,25	591,46	—	175	552	90,5	120	32	69,00		
94XH300	XH30094			6A		94	665,00	662,20	—	175	623	90,5	120	32	81,00		
96XH300	XH30096			6A		96	679,15	676,35	—	175	637	90,5	120	32	85,00		
118XH300	XH30118			6A		118	834,78	831,99	—	175	792	90,5	120	32	116,00		
120XH300	XH30120			6A		120	848,93	846,14	—	175	806	90,5	120	32	121,00		

## XH 400 - 7/8" (22,225 mm)

Caratteristiche Features Merkmale Características	Codice Code symbol Fabriknummer Code symbole Numero de fabrica	Nostro codice Our code Unser kode Notre code Nuestro codigo	Tipo Type Typ Type Tipo	Tipo flangia Flanges type Bordscheiben Typ Type flasques Tipo tapetas	N. denti N. of teeth Zahnezahl N. bre de dents Cantidad de dientes	Dp	De	Df	Dm	Di	F	L	Foro stock Stock bore Vor bohrung Alesage en stock Agujero de stock	Peso Weight / Gewicht Poids / Peso Kg			
Acciaio / Steel / Stahl Acier / Acero	con flangia / with flanges mit Flanges / avec flasques / con tapetas	18XH400	XH40018	6F	F44	18	127,34	124,55	140	100	—	118	132	32	9,50		
		19XH400	XH40019	6F	F46	19	134,41	131,62	146	100	—	118	132	32	10,65		
		20XH400	XH40020	6F	F50	20	141,49	138,69	154	100	—	118	132	32	11,80		
		21XH400	XH40021	6F	F51	21	148,56	145,77	160	110	—	118	132	32	13,20		
		22XH400	XH40022	6F	F52	22	155,64	152,84	168	110	—	118	132	32	14,73		
		24XH400	XH40024	6F	F81	24	169,79	166,99	184	120	—	118	132	32	17,80		
		25XH400	XH40025	6F	F56	25	176,86	174,07	192	120	—	118	132	32	19,40		
		26XH400	XH40026	6F	F59	26	183,94	181,14	200	120	—	118	132	32	21,10		
		27XH400	XH40027	6F	F59	27	191,01	188,22	200	120	—	118	132	32	22,80		
		28XH400	XH40028	6F	F61	28	198,08	195,29	211	150	—	118	132	32	22,60		
		30XH400	XH40030	6F	F62	30	212,23	209,44	226	150	—	118	132	32	28,70		
		32XH400	XH40032	6F	F64	32	226,38	223,59	240	150	—	118	132	32	32,50		
		34XH400	XH40034	6F	F66	34	240,53	237,74	256	150	—	118	132	32	36,50		
		38XH400	XH40038	6WF	F69	38	268,83	266,03	286	150	227	118	132	32	40,00		
		40XH400	XH40040	6WF	F70	40	282,98	280,18	296	150	241	118	132	32	32,90		
		Ghisa / Cast iron / Grauguss Fonte / Hierro fundido	senza flangia / without flanges ohne Flanschen / sans flasques sin tapetas	46XH400	XH40046	6W		46	325,42	322,63	—	175	283	118	132	32	38,00
				48XH400	XH40048	6W		48	339,57	336,78	—	175	297	118	132	32	41,00
				50XH400	XH40050	6W		50	410,32	407,52	—	175	368	118	132	32	46,00
				60XH400	XH40060	6W		60	424,47	421,67	—	175	382	118	132	32	47,00
				70XH400	XH400												

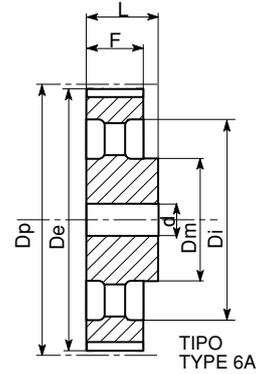
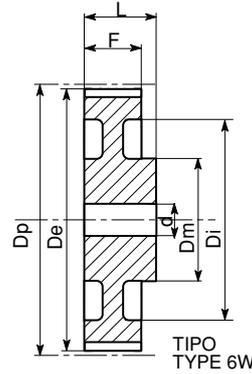
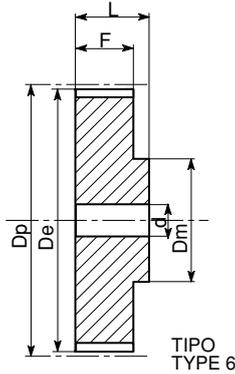
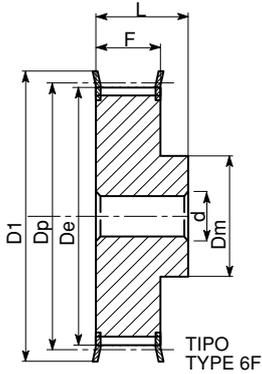

**XXH 200 - 1" 1/4 (31,750 mm)**

Caratteristiche Features Merkmale Características Características	Codice Code symbol Fabriknummer Code symbole Numero de fabrica	Nostro codice Our code Unser kode Notre code Nuestro codigo	Tipo Type Typ Type Tipo	Tipo flangia Flanges type Bordscheiben Typ Type flasques Tipo tapetas	N. denti N. of teeth Zahnezahl N. bre de dents Cantidad de dientes	Dp	De	Df	Dm	Di	F	L	Foro stock Stock bore Vor bohrung Alesage en stock Agujero de stock	Peso Weight / Gewicht Poids / Peso Kg	
Acciaio / Steel / Stahl Acier / Acero	con flangia / with flanges mit Flanges / avec flasques con tapetas	<b>18XXH200</b>	<b>XXH2018</b>	6F	F58	18	181,91	178,87	198	140	—	64,2	100	28	14,2
		<b>19XXH200</b>	<b>XXH2019</b>	6F	F60	19	192,02	188,97	205	140	—	64,2	100	28	15,8
		<b>20XXH200</b>	<b>XXH2020</b>	6F	F61	20	202,13	199,08	212	150	—	64,2	100	28	17,3
		<b>21XXH200</b>	<b>XXH2021</b>	6F	F62	21	212,23	209,19	226	150	—	64,2	100	28	18,5
		<b>22XXH200</b>	<b>XXH2022</b>	6F	F64	22	222,34	219,29	240	150	—	64,2	100	28	20,0
Ghisa / Cast iron / Grauguss Fonte / Hierro fundido	senza flangia / without flanges ohne Flanschen / sans flasques sin tapetas	<b>24XXH200</b>	<b>XXH2024</b>	6		24	242,55	239,50	—	150	—	64,2	100	28	23,6
		<b>25XXH200</b>	<b>XXH2025</b>	6W		25	252,66	249,61	—	150	196	64,2	100	28	18,0
		<b>26XXH200</b>	<b>XXH2026</b>	6W		26	262,76	259,79	—	150	207	64,2	100	28	20,0
		<b>27XXH200</b>	<b>XXH2027</b>	6W		27	272,87	269,82	—	150	216	64,2	100	28	24,0
		<b>30XXH200</b>	<b>XXH2030</b>	6W		30	303,19	300,14	—	150	247	64,2	100	28	26,0
		<b>34XXH200</b>	<b>XXH2034</b>	6W		34	343,62	340,57	—	150	287	64,2	100	28	31,8
		<b>40XXH200</b>	<b>XXH2040</b>	6W		40	404,25	401,21	—	150	348	64,2	100	28	43,0
		<b>48XXH200</b>	<b>XXH2048</b>	6W		48	485,10	482,06	—	175	429	64,2	100	32	60,4
		<b>60XXH200</b>	<b>XXH2060</b>	6A		60	606,38	603,33	—	175	547	64,2	120	32	100,0
		<b>72XXH200</b>	<b>XXH2072</b>	6A		72	727,66	724,61	—	175	668	64,2	120	38	130,0
<b>90XXH200</b>	<b>XXH2090</b>	6A		90	909,57	906,52	—	175	850	64,2	120	38	156,0		

**XXH 300 - 1" 1/4 (31,750 mm)**

Caratteristiche Features Merkmale Características Características	Codice Code symbol Fabriknummer Code symbole Numero de fabrica	Nostro codice Our code Unser kode Notre code Nuestro codigo	Tipo Type Typ Type Tipo	Tipo flangia Flanges type Bordscheiben Typ Type flasques Tipo tapetas	N. denti N. of teeth Zahnezahl N. bre de dents Cantidad de dientes	Dp	De	Df	Dm	Di	F	L	Foro stock Stock bore Vor bohrung Alesage en stock Agujero de stock	Peso Weight / Gewicht Poids / Peso Kg	
Acciaio / Steel / Stahl Acier / Acero	con flangia / with flanges mit Flanges / avec flasques con tapetas	<b>18XXH300</b>	<b>XXH30018</b>	6F	F58	18	181,91	178,87	198	140	—	91,4	110	28	16,0
		<b>19XXH300</b>	<b>XXH30019</b>	6F	F60	19	192,02	188,97	205	140	—	91,4	110	28	18,4
		<b>20XXH300</b>	<b>XXH30020</b>	6F	F61	20	202,13	199,08	212	150	—	91,4	110	28	20,4
		<b>21XXH300</b>	<b>XXH30021</b>	6F	F62	21	212,23	209,19	226	150	—	91,4	110	28	22,0
		<b>22XXH300</b>	<b>XXH30022</b>	6F	F64	22	222,34	219,29	240	150	—	91,4	110	28	25,0
Ghisa / Cast iron / Grauguss Fonte / Hierro fundido	senza flangia / without flanges ohne Flanschen / sans flasques sin tapetas	<b>24XXH300</b>	<b>XXH30024</b>	6		24	242,55	239,50	—	150	—	91,4	110	28	29,2
		<b>25XXH300</b>	<b>XXH30025</b>	6W		25	252,66	249,61	—	150	196	91,4	110	28	24,6
		<b>26XXH300</b>	<b>XXH30026</b>	6W		26	262,76	259,79	—	150	207	91,4	110	28	27,0
		<b>27XXH300</b>	<b>XXH30027</b>	6W		27	272,87	269,82	—	150	216	91,4	110	28	29,0
		<b>30XXH300</b>	<b>XXH30030</b>	6W		30	303,19	300,14	—	150	247	91,4	110	28	31,0
		<b>34XXH300</b>	<b>XXH30034</b>	6W		34	343,62	340,57	—	150	287	91,4	110	28	39,0
		<b>40XXH300</b>	<b>XXH30040</b>	6W		40	404,25	401,21	—	150	348	91,4	110	28	45,0
		<b>48XXH300</b>	<b>XXH30048</b>	6W		48	485,10	482,06	—	175	429	91,4	110	32	60,0
		<b>60XXH300</b>	<b>XXH30060</b>	6A		60	606,38	603,33	—	175	547	91,4	120	32	100,0
		<b>72XXH300</b>	<b>XXH30072</b>	6A		72	727,66	724,61	—	175	668	91,4	120	38	135,0
<b>90XXH300</b>	<b>XXH30090</b>	6A		90	909,57	906,52	—	175	850	91,4	120	38	160,0		

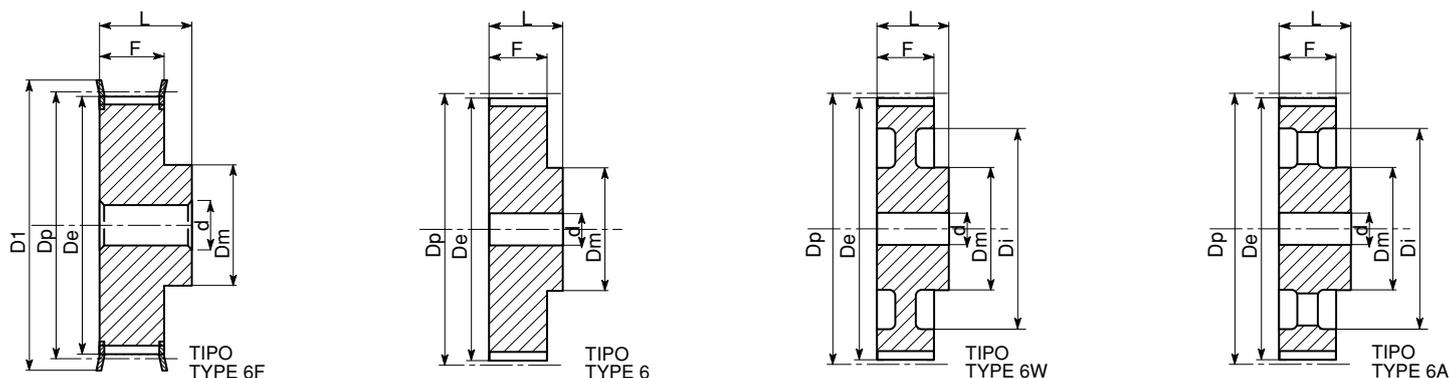

**XXH 400** - 1" 1/4 (31,750 mm)

Caratteristiche Features Merkmale Características Características	Codice Code symbol Fabriknummer Code symbole Numero de fabrica	Nostro codice Our code Unser kode Notre code Nuestro codigo	Tipo Type Typ Type Tipo	Tipo flangia Flanges type Bordscheiben Typ Type flasques Tipo tapetas	N. denti N. of teeth Zahnezahl N. bre de dents Cantidad de dientes	Dp	De	Df	Dm	Di	F	L	Foro stock Stock bore Vor bohrung Alesage en stock Agujero de stock	Peso Weight / Gewicht Poids / Peso Kg	
Acciaio / Steel / Stahl Acier / Acero	con flangia / with flanges mit Flanges / avec flasques con tapetas	<b>18XXH400</b>	<b>XXH4018</b>	6F	F58	18	181,91	178,87	198	140	—	120,7	140	32	20,8
		<b>19XXH400</b>	<b>XXH4019</b>	6F	F60	19	192,02	188,97	205	140	—	120,7	140	32	24,0
		<b>20XXH400</b>	<b>XXH4020</b>	6F	F61	20	202,13	199,08	212	150	—	120,7	140	32	26,0
		<b>21XXH400</b>	<b>XXH4021</b>	6F	F62	21	212,23	209,19	226	150	—	120,7	140	32	28,5
		<b>22XXH400</b>	<b>XXH4022</b>	6F	F64	22	222,34	219,29	240	150	—	120,7	140	32	31,6
Ghisa / Cast iron / Grauguss Fonte / Hierro fundido	senza flangia / without flanges ohne Flanschen / sans flasques sin tapetas	<b>24XXH400</b>	<b>XXH4024</b>	6		24	242,55	239,50	—	150	—	120,7	140	32	35,0
		<b>25XXH400</b>	<b>XXH4025</b>	6W		25	252,66	249,61	—	150	196	120,7	140	32	28,0
		<b>26XXH400</b>	<b>XXH4026</b>	6W		26	262,76	259,79	—	150	207	120,7	140	32	32,4
		<b>27XXH400</b>	<b>XXH4027</b>	6W		27	272,87	269,82	—	150	216	120,7	140	32	34,0
		<b>30XXH400</b>	<b>XXH4030</b>	6W		30	303,19	300,14	—	185	247	120,7	140	32	36,0
		<b>34XXH400</b>	<b>XXH4034</b>	6W		34	343,62	340,57	—	185	287	120,7	140	32	47,6
		<b>40XXH400</b>	<b>XXH4040</b>	6W		40	404,25	401,21	—	185	348	120,7	140	32	65,0
		<b>48XXH400</b>	<b>XXH4048</b>	6W		48	485,10	482,06	—	185	429	120,7	140	38	80,5
		<b>60XXH400</b>	<b>XXH4060</b>	6A		60	606,38	603,33	—	185	547	120,7	140	38	108,0
<b>72XXH400</b>	<b>XXH4072</b>	6A		72	727,66	724,61	—	220	668	120,7	140	38	140,0		
<b>90XXH400</b>	<b>XXH4090</b>	6A		90	909,57	906,52	—	220	850	120,7	140	38	170,0		

**XXH 500** - 1" 1/4 (31,750 mm)

Caratteristiche Features Merkmale Características Características	Codice Code symbol Fabriknummer Code symbole Numero de fabrica	Nostro codice Our code Unser kode Notre code Nuestro codigo	Tipo Type Typ Type Tipo	Tipo flangia Flanges type Bordscheiben Typ Type flasques Tipo tapetas	N. denti N. of teeth Zahnezahl N. bre de dents Cantidad de dientes	Dp	De	Df	Dm	Di	F	L	Foro stock Stock bore Vor bohrung Alesage en stock Agujero de stock	Peso Weight / Gewicht Poids / Peso Kg	
Acciaio / Steel / Stahl Acier / Acero	con flangia / with flanges mit Flanges / avec flasques con tapetas	<b>18XXH500</b>	<b>XXH5018</b>	6F	F58	18	181,91	178,87	198	140	—	145,3	168	32	24,0
		<b>19XXH500</b>	<b>XXH5019</b>	6F	F60	19	192,02	188,97	205	140	—	145,3	168	32	28,0
		<b>20XXH500</b>	<b>XXH5020</b>	6F	F61	20	202,13	199,08	212	150	—	145,3	168	32	31,4
		<b>21XXH500</b>	<b>XXH5021</b>	6F	F62	21	212,23	209,19	226	150	—	145,3	168	32	34,0
		<b>22XXH500</b>	<b>XXH5022</b>	6F	F64	22	222,34	219,29	240	150	—	145,3	168	32	38,3
Ghisa / Cast iron / Grauguss Fonte / Hierro fundido	senza flangia / without flanges ohne Flanschen / sans flasques sin tapetas	<b>24XXH500</b>	<b>XXH5024</b>	6		24	242,55	239,50	—	150	—	145,3	168	32	45,0
		<b>25XXH500</b>	<b>XXH5025</b>	6W		25	252,66	249,61	—	150	196	145,3	168	32	36,0
		<b>26XXH500</b>	<b>XXH5026</b>	6W		26	262,76	259,79	—	150	207	145,3	168	32	37,5
		<b>27XXH500</b>	<b>XXH5027</b>	6W		27	272,87	269,82	—	150	216	145,3	168	32	42,0
		<b>30XXH500</b>	<b>XXH5030</b>	6W		30	303,19	300,14	—	215	247	145,3	168	32	46,8
		<b>34XXH500</b>	<b>XXH5034</b>	6W		34	343,62	340,57	—	215	287	145,3	168	32	57,0
		<b>40XXH500</b>	<b>XXH5040</b>	6W		40	404,25	401,21	—	215	348	145,3	168	32	68,0
		<b>48XXH500</b>	<b>XXH5048</b>	6W		48	485,10	482,06	—	215	429	145,3	168	38	88,8
		<b>60XXH500</b>	<b>XXH5060</b>	6A		60	606,38	603,33	—	240	547	145,3	120	38	99,8
<b>72XXH500</b>	<b>XXH5072</b>	6A		72	727,66	724,61	—	240	668	145,3	120	38	172,0		
<b>90XXH500</b>	<b>XXH5090</b>	6A		90	909,57	906,52	—	240	850	145,3	120	38	242,5		

Le barre dentate XL e L sono costruite in acciaio UNI C 40 e in alluminio UNI 3571 TA 16, adatte alla anodizzazione. Le barre MXL sono costruite solo in alluminio.

The timing bars XL and L are made of steel UNI C 40 and of aluminium UNI 3571 TA 16, suitable for anodic treatment, whereas the bars MXL are made of aluminium only.

Die stangen XL und L sind aus stahl UNI C 40 und aluminium UNI 3571 TA 16 geeignet fuer anodischen oxydation. Die stangen MXL werden nur aus aluminium gefertigt.

Les barreaux dentes XL et L sont fabriqués en acier UNI C 40 et en aluminium UNI 3571 TA 16, apte au traitement anodi = que, tandis que les barreaux MXL ne sont fabriqués qu'en aluminium.

Las barras dentadas XL y L se construyen en acero UNI C 40 y en aluminio UNI 3571 TA 16 para la oxidacion anodica, mientras que las barras MXL solo se fabrican en aluminio.

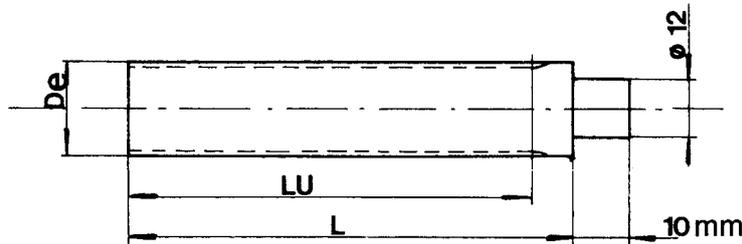

### MXL - 0.080" (mm 2,032)

### XL - 1/5" (mm 5,08)

### L - 3/8" (mm 9,525)

Codice Code symbol Fabriknummer Code symbole Numero de fabrica	Nostro codice Our code Unser kode Notre code Nuestro codigo	N. denti N. of teeth Zahnezahl N. bre de dents Cantidad de dientes	De	LU	L	Codice Code symbol Fabriknummer Code symbole Numero de fabrica	Nostro codice Our code Unser kode Notre code Nuestro codigo		N. denti N. of teeth Zahnezahl N. bre de dents Cantidad de dientes	De	LU	L	Codice Code symbol Fabriknummer Code symbole Numero de fabrica	Nostro codice Our code Unser kode Notre code Nuestro codigo		N. denti N. of teeth Zahnezahl N. bre de dents Cantidad de dientes	De	LU	L
							AL	C40						AL	C40				
<b>MXL 11</b>	BMXL 011	11	6,60	50	75	<b>XL 10</b>	BXLA 010	BXLC 010	10	15,66	125	140	<b>L 10</b>	BOLA 010	BOLC 010	10	29,56	140	140
<b>MXL 12</b>	BMXL 012	12	7,26	50	75	<b>XL 11</b>	BXLA 011	BXLC 011	11	17,28	125	140	<b>L 11</b>	BOLA 011	BOLC 011	11	32,59	140	140
<b>MXL 13</b>	BMXL 013	13	7,90	50	75	<b>XL 12</b>	BXLA 012	BXLC 012	12	18,90	125	140	<b>L 12</b>	BOLA 012	BOLC 012	12	35,62	160	160
<b>MXL 14</b>	BMXL 014	14	8,56	50	75	<b>XL 13</b>	BXLA 013	BXLC 013	13	20,51	125	140	<b>L 13</b>	BOLA 013	BOLC 013	13	38,65	160	160
<b>MXL 15</b>	BMXL 015	15	9,19	50	75	<b>XL 14</b>	BXLA 014	BXLC 014	14	22,13	132	140	<b>L 14</b>	BOLA 014	BOLC 014	14	41,68	160	160
<b>MXL 16</b>	BMXL 016	16	9,83	50	75	<b>XL 15</b>	BXLA 015	BXLC 015	15	23,75	132	140	<b>L 15</b>	BOLA 015	BOLC 015	15	44,72	160	160
<b>MXL 17</b>	BMXL 017	17	10,49	50	75	<b>XL 16</b>	BXLA 016	BXLC 016	16	25,36	140	140	<b>L 16</b>	BOLA 016	BOLC 016	16	47,75	160	160
<b>MXL 18</b>	BMXL 018	18	11,12	50	75	<b>XL 17</b>	BXLA 017	BXLC 017	17	26,98	140	140	<b>L 17</b>	BOLA 017	BOLC 017	17	50,78	160	160
<b>MXL 19</b>	BMXL 019	19	11,78	90	120	<b>XL 18</b>	BXLA 018	BXLC 018	18	28,60	140	140	<b>L 18</b>	BOLA 018	BOLC 018	18	53,81	160	160
<b>MXL 20</b>	BMXL 020	20	12,42	90	120	<b>XL 19</b>	BXLA 019	BXLC 019	19	30,22	140	140	<b>L 19</b>	BOLA 019	BOLC 019	19	56,84	160	160
<b>MXL 21</b>	BMXL 021	21	13,08	90	120	<b>XL 20</b>	BXLA 020	BXLC 020	20	31,83	140	140	<b>L 20</b>	BOLA 020	BOLC 020	20	59,88	160	160
<b>MXL 22</b>	BMXL 022	22	13,72	125	140	<b>XL 21</b>	BXLA 021	BXLC 021	21	33,45	160	160	<b>L 21</b>	BOLA 021	BOLC 021	21	62,91	160	160
<b>MXL 23</b>	BMXL 023	23	14,38	125	140	<b>XL 22</b>	BXLA 022	BXLC 022	22	35,07	160	160	<b>L 22</b>	BOLA 022	BOLC 022	22	65,94	160	160
<b>MXL 24</b>	BMXL 024	24	15,01	125	140	<b>XL 23</b>	BXLA 023	BXLC 023	23	36,60	160	160	<b>L 23</b>	BOLA 023	BOLC 023	23	68,97	160	160
<b>MXL 25</b>	BMXL 025	25	15,67	125	140	<b>XL 24</b>	BXLA 024	BXLC 024	24	38,30	160	160	<b>L 24</b>	BOLA 024	BOLC 024	24	72,00	160	160
<b>MXL 26</b>	BMXL 026	26	16,31	125	140	<b>XL 25</b>	BXLA 025	BXLC 025	25	39,93	160	160	<b>L 27</b>	BOLA 027	BOLC 027	27	81,10	160	160
<b>MXL 27</b>	BMXL 027	27	16,94	125	140	<b>XL 26</b>	BXLA 026	BXLC 026	26	41,53	160	160	<b>L 30</b>	BOLA 030	BOLC 030	30	90,20	160	160
<b>MXL 28</b>	BMXL 028	28	16,70	125	140	<b>XL 27</b>	BXLA 027	BXLC 027	27	43,15	160	160							
<b>MXL 29</b>	BMXL 029	29	18,24	125	140	<b>XL 28</b>	BXLA 028	BXLC 028	28	44,77	160	160							
<b>MXL 30</b>	BMXL 030	30	18,90	125	140	<b>XL 29</b>	BXLA 029	BXLC 029	29	46,39	160	160							
<b>MXL 32</b>	BMXL 032	32	20,19	125	140	<b>XL 30</b>	BXLA 030	BXLC 030	30	48,00	160	160							
<b>MXL 34</b>	BMXL 034	34	21,49	125	140	<b>XL 32</b>	BXLA 032	BXLC 032	32	51,24	160	160							
<b>MXL 35</b>	BMXL 035	35	22,12	132	140	<b>XL 34</b>	BXLA 034	BXLC 034	34	54,47	160	160							
<b>MXL 36</b>	BMXL 036	36	22,78	132	140	<b>XL 35</b>	BXLA 035	BXLC 035	35	56,09	160	160							
<b>MXL 38</b>	BMXL 038	38	24,08	132	140	<b>XL 36</b>	BXLA 036	BXLC 036	36	57,70	160	160							
<b>MXL 40</b>	BMXL 040	40	25,37	132	140	<b>XL 38</b>	BXLA 038	BXLC 038	38	60,94	160	160							
<b>MXL 42</b>	BMXL 042	42	26,67	140	140	<b>XL 40</b>	BXLA 040	BXLC 040	40	64,17	160	160							
<b>MXL 44</b>	BMXL 044	44	27,94	140	140	<b>XL 42</b>	BXLA 042	BXLC 042	42	67,41	160	160							
<b>MXL 45</b>	BMXL 045	45	28,60	140	140	<b>XL 44</b>	BXLA 044	BXLC 044	44	70,64	160	160							
<b>MXL 48</b>	BMXL 048	48	30,53	140	140	<b>XL 45</b>	BXLA 045	BXLC 045	45	72,26	160	160							
<b>MXL 50</b>	BMXL 050	50	32,33	140	140	<b>XL 48</b>	BXLA 048	BXLC 048	48	77,11	160	160							
<b>MXL 60</b>	BMXL 060	60	38,30	160	160	<b>XL 50</b>	BXLA 050	BXLC 050	50	80,33	160	160							
<b>MXL 64</b>	BMXL 064	64	40,89	160	160	<b>XL 60</b>	BXLA 060	BXLC 060	60	96,51	160	160							
<b>MXL 65</b>	BMXL 065	65	41,53	160	160	<b>XL 64</b>	BXLA 064	BXLC 064	64	102,95	160	160							
<b>MXL 70</b>	BMXL 070	70	44,78	160	160	<b>XL 65</b>	BXLA 065	BXLC 065	65	104,56	160	160							
<b>MXL 72</b>	BMXL 072	72	46,05	160	160	<b>XL 70</b>	BXLA 070	BXLC 070	70	112,68	160	160							
<b>MXL 75</b>	BMXL 075	75	48,01	160	160	<b>XL 72</b>	BXLA 072	BXLA 072	72	115,92	160	160							
<b>MXL 90</b>	BMXL 090	90	57,71	160	160														
<b>MXL 110</b>	BMXL 110	110	70,64	160	160														

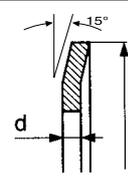
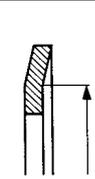
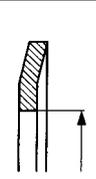

N. denti N. of teeth Zahnezahl N. bre de dents Cantidad de dientes	Flangia / Flanges / Bordscheiben / Flasques / Tapetas					
	d = 0,5 mm	d = 1 mm	d = 1,5 mm	d = 1,5 mm	d = 2,5 mm	d = 2,5 mm
	<b>MXL</b>	<b>XL</b>	<b>L</b>	<b>H</b>	<b>XH</b>	<b>XXH</b>
8	-	-	-	-	-	-
9	-	-	-	-	-	-
10	-	F 07	F 13	-	-	-
11	-	F 07	F 13	-	-	-
12	-	F 08	F 16	-	-	-
13	-	F 08	F 17	-	-	-
14	-	F 09	F 18	F 24	-	-
15	-	F 09	F 19	F 25	-	-
16	F 02	F 10	F 20	F 26	-	-
17	-	F 10	F 21	F 27	-	-
18	F 03	F 11	F 22	F 28	F 44	F 58
19	-	F 11	F 24	F 29	F 46	F 60
20	F 03	F 14	F 25	F 30	F 49	F 61
21	-	F 14	F 26	F 31	F 51	F 62
22	F 04	F 15	F 27	F 32	F 52	F 64
23	-	-	F 28	F 33	-	-
24	F 06	F 17	F 28	F 34	F 81	-
25	-	-	F 29	F 35	F 56	-
26	-	F 18	F 30	F 36	F 59	-
27	-	F 18	F 30	F 37	F 59	-
28	F 08	F 19	F 31	F 38	F 61	-
29	-	F 19	F 32	F 39	-	-
30	F 08	F 24	F 33	F 40	F 62	-
31	-	-	-	-	-	-
32	F 08	F 21	F 34	F 42	F 64	-
33	-	-	F 35	F 44	-	-
34	-	-	F 34	F 48	F 66	-
35	-	-	F 36	F 48	-	-
36	F 09	-	F 37	F 48	-	-
37	-	-	-	-	-	-
38	-	-	-	F 50	F 69	-
39	-	-	-	-	-	-
40	F 10	-	F 40	F 52	F 70	-
41	-	-	F 41	-	-	-
42	F 10	-	F 42	F 53	-	-
43	-	-	-	-	-	-
44	F 13	-	F 45	F 55	-	-
45	-	-	F 45	F 57	-	-
46	-	-	-	-	-	-
47	-	-	F 48	-	-	-
48	-	-	F 48	F 59	-	-
49	-	-	-	-	-	-
50	-	-	-	-	-	-
51	-	-	-	-	-	-
52	-	-	-	-	-	-
53	-	-	-	-	-	-
54	-	-	-	-	-	-
55	-	-	-	-	-	-
56	-	-	-	-	-	-
57	-	-	-	-	-	-
58	-	-	-	-	-	-
59	-	-	-	-	-	-
60	-	-	-	-	-	-
61	-	-	-	-	-	-
63	-	-	-	-	-	-
64	-	-	-	-	-	-
65	-	-	-	-	-	-
66	-	-	-	-	-	-
67	-	-	-	-	-	-
68	-	-	-	-	-	-
69	-	-	-	-	-	-
70	-	-	-	-	-	-
71	-	-	-	-	-	-
72	-	-	-	-	-	-
73	-	-	-	-	-	-
74	-	-	-	-	-	-
75	-	-	-	-	-	-
76	-	-	-	-	-	-
77	-	-	-	-	-	-
78	-	-	-	-	-	-
79	-	-	-	-	-	-
80	-	-	-	-	-	-
81	-	-	-	-	-	-
82	-	-	-	-	-	-
83	-	-	-	-	-	-
84	-	-	-	-	-	-
85	-	-	-	-	-	-
86	-	-	-	-	-	-
87	-	-	-	-	-	-
88	-	-	-	-	-	-
89	-	-	-	-	-	-
90	-	-	-	-	-	-

Tipo flangia Flanges type Bordscheiben Typ Type flasques Tipo tapetas			
<b>F 01</b>	13,0	10,0	6,0
<b>F 02</b>	15,0	12,0	8,0
<b>F 03</b>	16,0	13,0	9,5
<b>F 04</b>	17,5	14,5	11,6
<b>F 05</b>	18,0	15,0	11,5
<b>F 06</b>	20,0	16,5	12,2
<b>F 07</b>	23,0	18,0	12,5
<b>F 08</b>	25,0	21,5	15,0
<b>F 09</b>	28,0	24,0	17,8
<b>F 10</b>	32,0	27,5	23,0
<b>F 11</b>	35,0	30,5	23,0
<b>F 12</b>	36,0	31,0	25,0
<b>F 13</b>	37,0	33,0	25,0
<b>F 14</b>	38,0	34,0	26,5
<b>F 15</b>	42,0	38,0	30,5
<b>F 16</b>	43,0	39,0	31,0
<b>F 17</b>	44,0	40,5	32,5
<b>F 18</b>	48,0	43,5	37,0
<b>F 19</b>	51,0	47,0	40,0
<b>F 20</b>	54,0	50,5	43,0
<b>F 21</b>	57,0	52,0	46,0
<b>F 22</b>	60,0	57,0	47,0
<b>F 23</b>	61,0	56,5	49,0
<b>F 24</b>	64,0	57,0	47,0
<b>F 25</b>	66,0	63,0	52,0
<b>F 26</b>	70,0	66,5	53,0
<b>F 27</b>	75,0	68,5	60,0
<b>F 28</b>	79,0	72,5	60,0
<b>F 29</b>	83,0	78,0	68,0
<b>F 30</b>	87,0	82,5	72,0
<b>F 31</b>	91,0	85,5	76,0
<b>F 32</b>	93,0	89,0	80,0
<b>F 33</b>	97,0	93,8	83,0
<b>F 34</b>	102,0	97,0	82,5
<b>F 35</b>	106,0	101,0	90,0
<b>F 36</b>	112,0	105,5	91,0
<b>F 37</b>	115,0	109,0	94,0
<b>F 38</b>	120,0	112,5	99,5
<b>F 39</b>	123,0	117,5	107,0
<b>F 40</b>	128,0	124,0	107,0
<b>F 41</b>	131,0	125,5	115,0
<b>F 42</b>	135,0	128,5	115,0
<b>F 43</b>	138,0	132,0	121,0
<b>F 44</b>	140,0	125,0	107,0
<b>F 45</b>	142,0	137,0	120,0
<b>F 46</b>	146,0	133,0	107,0
<b>F 47</b>	148,0	143,0	132,0
<b>F 48</b>	150,0	145,0	130,0
<b>F 49</b>	154,0	142,0	122,0
<b>F 50</b>	158,0	153,0	138,5
<b>F 51</b>	160,0	148,0	120,0
<b>F 52</b>	168,0	161,0	148,0
<b>F 53</b>	175,0	170,0	157,0
<b>F 54</b>	180,0	174,0	154,0
<b>F 55</b>	184,0	177,0	162,0
<b>F 56</b>	188,0	176,0	150,0
<b>F 57</b>	192,0	187,0	173,0
<b>F 58</b>	198,0	180,0	150,0
<b>F 59</b>	200,0	193,0	180,0
<b>F 60</b>	205,0	189,0	160,0
<b>F 61</b>	212,0	200,0	162,0
<b>F 62</b>	226,0	214,0	190,0
<b>F 63</b>	230,0	222,0	200,0
<b>F 64</b>	240,0	224,0	192,0
<b>F 65</b>	250,0	228,0	200,0
<b>F 66</b>	256,0	240,0	220,0
<b>F 67</b>	265,0	240,0	213,0
<b>F 68</b>	275,0	253,0	225,0
<b>F 69</b>	286,0	277,0	242,0
<b>F 70</b>	296,0	287,0	260,0
<b>F 71</b>	300,0	280,0	252,0
<b>F 72</b>	325,0	305,0	278,0
<b>F 73</b>	350,0	330,0	302,0
<b>F 74</b>	375,0	355,0	328,0
<b>F 75</b>	405,0	380,0	354,0
<b>F 76</b>	430,0	406,0	380,0
<b>F 77</b>	455,0	432,0	405,0
<b>F 78</b>	480,0	457,0	430,0
<b>F 79</b>	530,0	508,0	481,0
<b>F 80</b>	595,0	572,0	544,0
<b>F 81</b>	184,0	168,0	135,0



**Pulegge dentate per bussola conica**  
**Timing belt pulleys for taper bushes**  
**Zahnriemenscheiben für Spannbüchsen**  
**Poulies dentées à moyeu amovible**  
**Poleas dentadas para**  
**casquillos cónicos (taper)**

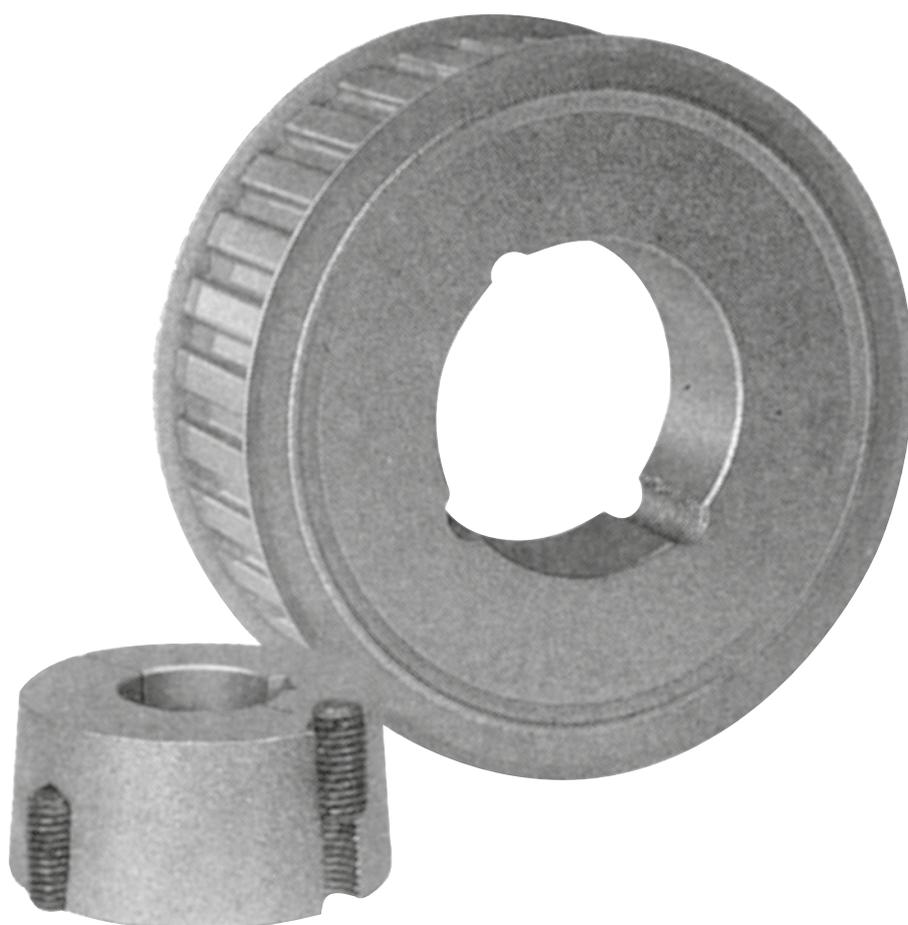

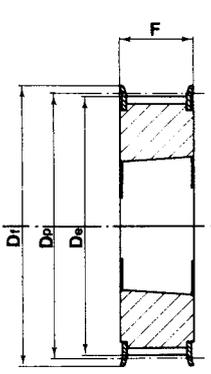

Tipo / Type  
3F

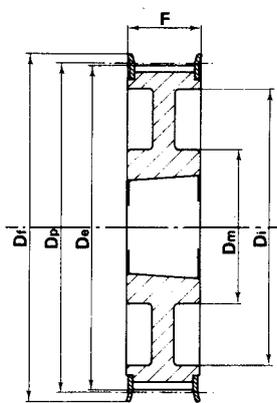

Tipo / Type  
3WF

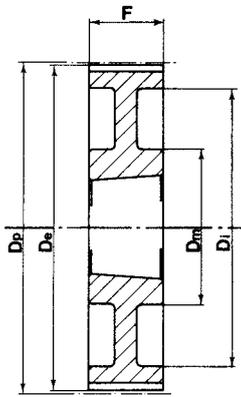

Tipo / Type  
3W

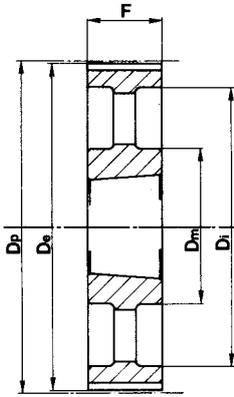

Tipo / Type  
3A

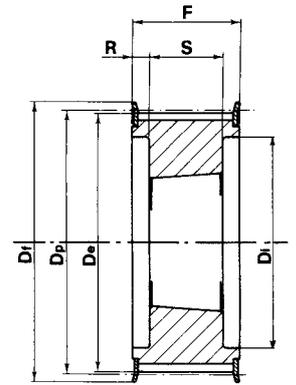

Tipo / Type  
4F

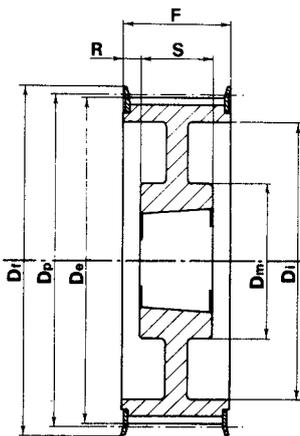

Tipo / Type  
4WF

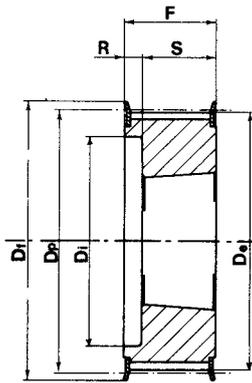

Tipo / Type  
5F

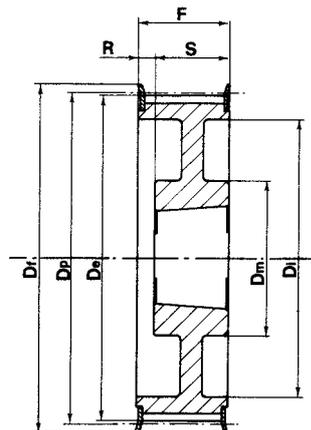

Tipo / Type  
5WF

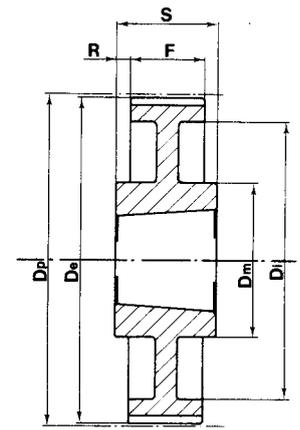

Tipo / Type  
7W

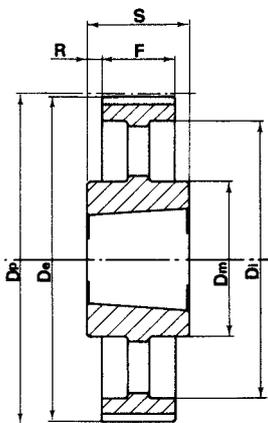

Tipo / Type  
7A

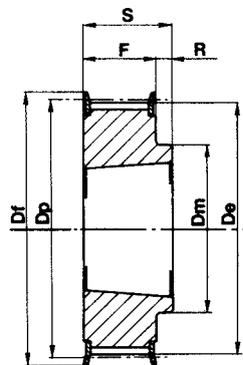

Tipo / Type  
8F

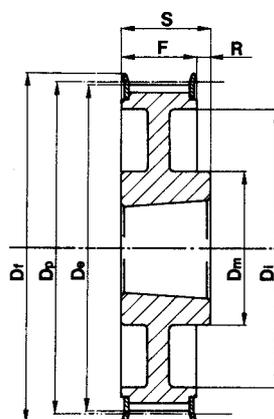

Tipo / Type  
8WF

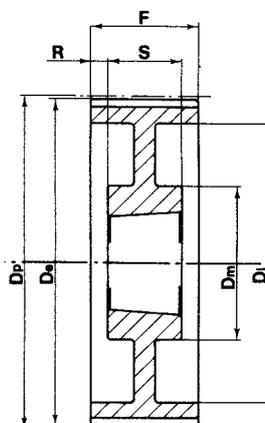

Tipo / Type  
9W

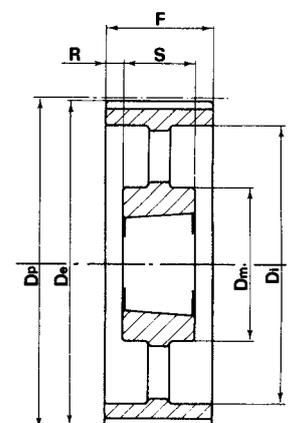

Tipo / Type  
9A



**Pulegge dentate per bussola conica / Timing belt pulleys for taper bushes**  
**Zahnriemenscheiben für Spannbüchsen / Poulies dentées à moyeu amovible**  
**Poleas dentadas para casquillos cónicos (taper)**



**L 050 - 3/8" (9,525 mm)**

Caratteristiche Features Merkmale Características	Codice Code symbol Fabriknummer Code symbole Numero de fabrica	Nostro codice Our code Unser kode Notre code Nuestro codigo	Tipo Type Typ Type Tipo	Tipo flangia Flanges type Bordscheiben Typ Type flasques Tipo tapetas	Bussola Bush Buchse Moyeu Casquillo	Foro max. Max. Bore Max. Bohrung Alesage max. Agujero max.	Dp	De	Df	Dm	Di	F	S	R	Peso Weight / Gewicht Poids / Peso Kg	
Acciaio / Steel / Stahl Acier / Acero	con flangia / with flanges mit Flanges / avec flasques / con tapetas	<b>18L050</b>	<b>TL50018</b>	8F	F22	1108	28	54,57	53,81	60	45	-	19,0	22,0	3	0,2
		<b>19L050</b>	<b>TL50019</b>	8F	F24	1108	28	57,61	56,84	64	45	-	19,0	22,0	3	0,2
		<b>20L050</b>	<b>TL50020</b>	8F	F25	1108	28	60,64	59,88	66	48	-	19,0	22,0	3	0,2
		<b>21L050</b>	<b>TL50021</b>	8F	F26	1108	28	63,67	62,91	70	48	-	19,0	22,0	3	0,3
		<b>22L050</b>	<b>TL50022</b>	8F	F27	1108	28	66,70	65,94	75	51	-	19,0	22,0	3	0,3
		<b>23L050</b>	<b>TL50023</b>	8F	F28	1108	28	69,73	68,97	79	54	-	19,0	22,0	3	0,4
		<b>24L050</b>	<b>TL50024</b>	8F	F28	1108	28	72,77	72,00	79	54	-	19,0	22,0	3	0,4
		<b>25L050</b>	<b>TL50025</b>	8F	F29	1108	28	75,80	75,04	83	56	-	19,0	22,0	3	0,5
		<b>26L050</b>	<b>TL50026</b>	8F	F30	1108	28	78,83	78,07	87	60	-	19,0	22,0	3	0,5
		<b>27L050</b>	<b>TL50027</b>	8F	F30	1108	28	81,86	81,10	87	62	-	19,0	22,0	3	0,6
		<b>28L050</b>	<b>TL50028</b>	8F	F31	1108	28	84,89	84,13	91	65	-	19,0	22,0	3	0,6
		<b>30L050</b>	<b>TL50030</b>	8F	F33	1108	28	90,96	90,20	97	70	-	19,0	22,0	3	0,8
		<b>32L050</b>	<b>TL50032</b>	8F	F34	1108	28	97,02	96,26	102	74	-	19,0	22,0	3	0,9
		<b>36L050</b>	<b>TL50036</b>	8F	F37	1108	28	109,15	108,39	115	85	-	19,0	22,0	3	1,2
		<b>40L050</b>	<b>TL50040</b>	8F	F40	1610	42	121,28	120,51	128	88	-	19,0	25,0	3	1,5
<b>44L050</b>	<b>TL50044</b>	8WF	F45	1610	42	133,40	132,64	142	88	110	19,0	25,0	6	1,8		
<b>48L050</b>	<b>TL50048</b>	8WF	F48	1610	42	145,53	144,77	150	88	120	19,0	25,0	6	2,3		
Ghisa / Cast iron Grauguss / Fonte Hierro fundido	senza flangia / without flanges ohne Flanschen sans flasques / sin tapetas	<b>60L050</b>	<b>TL50060</b>	7W		1610	42	181,91	181,15	-	92	166	19,0	25,0	6	2,0
		<b>72L050</b>	<b>TL50072</b>	7A		1610	42	218,30	217,53	-	92	202	19,0	25,0	6	3,0
		<b>84L050</b>	<b>TL50084</b>	7A		1610	42	254,68	253,90	-	92	236	19,0	25,0	6	4,0
		<b>96L050</b>	<b>TL50096</b>	7A		2012	50	291,06	290,30	-	106	270	19,0	32,0	13	5,5
		<b>120L050</b>	<b>TL50120</b>	7A		2012	50	363,83	363,07	-	106	343	19,0	32,0	13	6,8

**Pulegge dentate per bussola conica / Timing belt pulleys for taper bushes**  
**Zahnriemenscheiben für Spannbüchsen / Poulies dentées à moyeu amovible**  
**Poleas dentadas para casquillos cónicos (taper)**

**L 075 - 3/8" (9,525 mm)**

Caratteristiche Features Merkmale Características	Codice Code symbol Fabriknummer Code symbole Numero de fabrica	Nostro codice Our code Unser kode Notre code Nuestro codiggo	Tipo Type Typ Type Tipo	Tipo flangia Flanges type Bordscheiben Typ Type flasques Tipo tapetas	Bussola Bush Buchse Moyeu Casquillo	Foro max. Max. Bore Max. Bohrung Alesage max. Agujero max.	Dp	De	Df	Dm	Di	F	S	R	Peso Weight / Gewicht Poids / Peso Kg	
Acciaio / Steel / Stahl Acier / Acero	con flangia / with flanges mit Flanges / avec flasques / con tapetas	<b>18L075</b>	<b>TL75018</b>	3F	F22	1108	28	54,57	53,81	60	-	25,0	25,0	-	0,2	
		<b>19L075</b>	<b>TL75019</b>	3F	F24	1108	28	57,61	56,84	64	-	25,0	25,0	-	0,3	
		<b>20L075</b>	<b>TL75020</b>	3F	F25	1108	28	60,64	59,88	66	-	25,0	25,0	-	0,3	
		<b>21L075</b>	<b>TL75021</b>	3F	F26	1108	28	63,67	62,91	70	-	25,0	25,0	-	0,4	
		<b>22L075</b>	<b>TL75022</b>	3F	F27	1108	28	66,70	65,94	75	-	25,0	25,0	-	0,4	
		<b>23L075</b>	<b>TL75023</b>	3F	F28	1108	28	69,73	68,97	79	-	25,0	25,0	-	0,4	
		<b>24L075</b>	<b>TL75024</b>	3F	F28	1108	28	72,77	72,00	79	-	25,0	25,0	-	0,5	
		<b>25L075</b>	<b>TL75025</b>	3F	F29	1108	28	75,80	75,04	83	-	25,0	25,0	-	0,6	
		<b>26L075</b>	<b>TL75026</b>	3F	F30	1108	28	78,83	78,07	87	-	25,0	25,0	-	0,6	
		<b>27L075</b>	<b>TL75027</b>	3F	F30	1108	28	81,86	81,10	87	-	25,0	25,0	-	0,7	
		<b>28L075</b>	<b>TL75028</b>	3F	F31	1108	28	84,89	84,13	91	-	25,0	25,0	-	0,7	
		<b>30L075</b>	<b>TL75030</b>	3F	F33	1108	28	90,96	90,20	97	-	25,0	25,0	-	0,9	
		<b>32L075</b>	<b>TL75032</b>	3F	F34	1108	28	97,02	96,26	102	-	25,0	25,0	-	1,0	
		<b>36L075</b>	<b>TL75036</b>	3F	F37	1610	42	109,15	108,39	115	-	25,0	25,0	-	1,2	
		<b>40L075</b>	<b>TL75040</b>	3F	F40	1610	42	121,28	120,51	128	-	25,0	25,0	-	1,7	
<b>44L075</b>	<b>TL75044</b>	3WF	F45	1610	42	133,40	132,64	142	90	110	25,0	25,0	-	2,1		
<b>48L075</b>	<b>TL75048</b>	3WF	F48	1610	42	145,53	144,77	150	92	120	25,0	25,0	-	2,5		
Ghisa / Cast iron Grauguss / Fonte Hierro fundido	senza flangia without flanges ohne Flanschen sans flasques sin tapetas	<b>60L075</b>	<b>TL75060</b>	3W		1610	42	181,91	181,15	-	92	166	25,0	25,0	-	3,0
		<b>72L075</b>	<b>TL75072</b>	3A		1610	42	218,30	217,53	-	92	202	25,0	25,0	-	4,0
		<b>84L075</b>	<b>TL75084</b>	7A		2012	50	254,68	253,90	-	92	236	25,0	32,0	-	5,2
		<b>96L075</b>	<b>TL75096</b>	7A		2012	50	291,06	290,30	-	106	270	25,0	32,0	3,5	6,5
		<b>120L075</b>	<b>TL75120</b>	7A		2012	50	363,83	363,07	-	106	343	25,0	32,0	3,5	7,6

**L 100 - 3/8" (9,525 mm)**

Caratteristiche Features Merkmale Características	Codice Code symbol Fabriknummer Code symbole Numero de fabrica	Nostro codice Our code Unser kode Notre code Nuestro codiggo	Tipo Type Typ Type Tipo	Tipo flangia Flanges type Bordscheiben Typ Type flasques Tipo tapetas	Bussola Bush Buchse Moyeu Casquillo	Foro max. Max. Bore Max. Bohrung Alesage max. Agujero max.	Dp	De	Df	Dm	Di	F	S	R	Peso Weight / Gewicht Poids / Peso Kg	
Acciaio / Steel / Stahl Acier / Acero	con flangia / with flanges mit Flanges / avec flasques / con tapetas	<b>18L100</b>	<b>TL10018</b>	5F	F22	1108	28	54,57	53,81	60	-	38	31,0	22,0	9,0	0,2
		<b>19L100</b>	<b>TL10019</b>	5F	F24	1108	28	57,61	56,84	64	-	38	31,0	22,0	9,0	0,3
		<b>20L100</b>	<b>TL10020</b>	5F	F25	1108	28	60,64	59,88	66	-	45	31,0	22,0	9,0	0,4
		<b>21L100</b>	<b>TL10021</b>	5F	F26	1108	28	63,67	62,91	70	-	45	31,0	22,0	9,0	0,4
		<b>22L100</b>	<b>TL10022</b>	5F	F27	1108	28	66,70	65,94	75	-	48	31,0	22,0	9,0	0,4
		<b>23L100</b>	<b>TL10023</b>	5F	F28	1108	28	69,73	68,97	79	-	52	32,0	22,0	10,0	0,5
		<b>24L100</b>	<b>TL10024</b>	5F	F28	1108	28	72,77	72,00	79	-	52	32,0	22,0	10,0	0,6
		<b>25L100</b>	<b>TL10025</b>	5F	F29	1108	28	75,80	75,04	83	-	54	32,0	22,0	10,0	0,6
		<b>26L100</b>	<b>TL10026</b>	5F	F30	1108	28	78,83	78,07	87	-	60	32,0	22,0	10,0	0,7
		<b>27L100</b>	<b>TL10027</b>	5F	F30	1108	28	81,86	81,10	91	-	60	32,0	22,0	10,0	0,8
		<b>28L100</b>	<b>TL10028</b>	5F	F31	1108	28	84,89	84,13	91	-	65	32,0	22,0	10,0	0,8
		<b>30L100</b>	<b>TL10030</b>	5F	F33	1210	32	90,96	90,20	97	-	71	32,0	25,0	7,0	0,9
		<b>32L100</b>	<b>TL10032</b>	5F	F34	1210	32	97,02	96,26	102	-	75	32,0	25,0	7,0	1,0
		<b>36L100</b>	<b>TL10036</b>	5F	F37	1610	42	109,15	108,39	115	-	86	32,0	25,0	7,0	1,4
		<b>40L100</b>	<b>TL10040</b>	5F	F40	1610	42	121,28	120,51	128	-	96	32,0	25,0	7,0	1,7
<b>44L100</b>	<b>TL10044</b>	5WF	F45	1610	42	133,40	132,64	142	90	110	32,0	25,0	-	2,3		
<b>48L100</b>	<b>TL10048</b>	5WF	F48	1610	42	145,53	144,77	150	92	120	32,0	25,0	7,0	2,7		
Ghisa / Cast iron Grauguss / Fonte Hierro fundido	senza flangia without flanges ohne Flanschen sans flasques sin tapetas	<b>60L100</b>	<b>TL10060</b>	9W		1610	42	181,91	181,15	-	92	166	32,0	25,0	3,5	2,4
		<b>72L100</b>	<b>TL10072</b>	3A		2012	50	218,30	217,53	-	92	202	32,0	32,0	-	4,4
		<b>84L100</b>	<b>TL10084</b>	3A		2012	50	254,68	253,90	-	92	236	32,0	32,0	-	6,0
		<b>96L100</b>	<b>TL10096</b>	3A		2012	50	291,06	290,30	-	106	270	32,0	32,0	-	7,1
		<b>120L100</b>	<b>TL10120</b>	3A		2012	50	363,83	363,07	-	106	343	32,0	32,0	-	8,5

**Pulegge dentate per bussola conica / Timing belt pulleys for taper bushes**  
**Zahnriemenscheiben für Spannbüchsen / Poulies dentées à moyeu amovible**  
**Poleas dentadas para casquillos cónicos (taper)**



**H 100 - 1/2" (12,7 mm)**

Caratteristiche Features Merkmale Características	Codice Code symbol Fabriknummer Code symbole Numero de fabrica	Nostro codice Our code Unser kode Notre code Nuestro codiglo	Tipo Type Typ Type Tipo	Tipo flangia Flanges type Bordscheiben Typ Type flasques Tipo tapetas	Bussola Bush Buchse Moyeu Casquillo	Foro max. Max. Bore Max. Bohrung Alesage max. Agujero max.	Dp	De	Df	Dm	Di	F	S	R	Peso Weight / Gewicht Poids / Peso Kg	
Acciaio / Steel / Stahl Acier / Acero	con flangia / with flanges mit Flanges / avec flasques / con tapetas	<b>16H100</b>	<b>TH10016</b>	5F	F26	1108	28	64,68	63,31	70	-	45	31,0	22,0	9,0	0,4
		<b>18H100</b>	<b>TH10018</b>	5F	F28	1210	32	72,77	71,39	79	-	52	31,0	25,0	6,0	0,5
		<b>19H100</b>	<b>TH10019</b>	5F	F29	1210	32	76,81	75,44	83	-	56	31,0	25,0	6,0	0,6
		<b>20H100</b>	<b>TH10020</b>	5F	F30	1210	32	80,55	79,48	87	-	60	31,0	25,0	6,0	0,7
		<b>21H100</b>	<b>TH10021</b>	5F	F31	1210	32	84,89	83,52	91	-	64	32,0	25,0	7,0	0,8
		<b>22H100</b>	<b>TH10022</b>	5F	F32	1210	32	88,94	87,56	93	-	67	32,0	25,0	7,0	0,9
		<b>23H100</b>	<b>TH10023</b>	5F	F33	1610	42	92,98	91,61	97	-	70	32,0	25,0	7,0	0,9
		<b>24H100</b>	<b>TH10024</b>	5F	F34	1610	42	97,02	95,65	102	-	74	32,0	25,0	7,0	1,0
		<b>25H100</b>	<b>TH10025</b>	5F	F35	1610	42	101,06	99,69	106	-	77	32,0	25,0	7,0	1,0
		<b>26H100</b>	<b>TH10026</b>	5F	F36	1610	42	105,11	103,73	112	-	82	32,0	25,0	7,0	1,2
		<b>27H100</b>	<b>TH10027</b>	5F	F37	1610	42	109,15	107,78	115	-	85	32,0	25,0	7,0	1,3
		<b>28H100</b>	<b>TH10028</b>	5F	F38	1610	42	113,19	111,82	120	-	90	32,0	25,0	7,0	1,5
		<b>30H100</b>	<b>TH10030</b>	5F	F40	1610	42	121,28	119,90	128	-	98	32,0	25,0	7,0	1,7
		<b>32H100</b>	<b>TH10032</b>	5WF	F42	1610	42	129,36	127,99	135	80	106	32,0	25,0	7,0	2,0
		<b>36H100</b>	<b>TH10036</b>	5WF	F48	1610	42	145,53	144,16	150	92	121	32,0	25,0	7,0	2,7
		<b>40H100</b>	<b>TH10040</b>	5WF	F52	1610	42	161,70	160,33	168	92	138	32,0	25,0	7,0	3,6
<b>44H100</b>	<b>TH10044</b>	3WF	F55	2012	50	177,87	176,50	184	106	152	32,0	32,0	-	3,8		
<b>48H100</b>	<b>TH10048</b>	3WF	F59	2012	50	194,04	192,67	200	106	169	32,0	32,0	-	3,2		
Ghisa / Cast iron Grauguss / Fonte Hierro fundido	senza flangia without flanges ohne Flanschen sans flasques sin tapetas	<b>60H100</b>	<b>TH10060</b>	9A		2012	50	242,55	241,18	-	92	223	34,0	32,0	1,0	4,8
		<b>72H100</b>	<b>TH10072</b>	9A		2012	50	291,06	289,69	-	92	270	34,0	32,0	1,0	5,7
		<b>84H100</b>	<b>TH10084</b>	9A		2012	50	339,57	338,20	-	92	318	34,0	32,0	1,0	6,8
		<b>96H100</b>	<b>TH10096</b>	7A		2517	60	388,08	386,71	-	106	366	34,0	45,0	5,5	8,2
		<b>120H100</b>	<b>TH10120</b>	7A		2517	60	485,10	483,73	-	106	462	34,0	45,0	5,5	12,1

**H 150 - 1/2" (12,7 mm)**

Caratteristiche Features Merkmale Características	Codice Code symbol Fabriknummer Code symbole Numero de fabrica	Nostro codice Our code Unser kode Notre code Nuestro codiglo	Tipo Type Typ Type Tipo	Tipo flangia Flanges type Bordscheiben Typ Type flasques Tipo tapetas	Bussola Bush Buchse Moyeu Casquillo	Foro max. Max. Bore Max. Bohrung Alesage max. Agujero max.	Dp	De	Df	Dm	Di	F	S	R	Peso Weight / Gewicht Poids / Peso Kg	
Acciaio / Steel / Stahl Acier / Acero	con flangia / with flanges mit Flanges / avec flasques / con tapetas	<b>18H150</b>	<b>TH15018</b>	5F	F28	1210	32	72,77	71,39	79	-	52	45,0	25,0	20,0	0,6
		<b>19H150</b>	<b>TH15019</b>	5F	F29	1210	32	76,81	75,44	83	-	56	45,0	25,0	20,0	0,7
		<b>20H150</b>	<b>TH15020</b>	5F	F30	1210	32	80,55	79,48	87	-	60	45,0	25,0	20,0	0,8
		<b>21H150</b>	<b>TH15021</b>	5F	F31	1210	32	84,89	83,52	91	-	64	45,0	25,0	20,0	1,0
		<b>22H150</b>	<b>TH15022</b>	5F	F32	1210	32	88,94	87,56	93	-	67	45,0	25,0	20,0	1,2
		<b>23H150</b>	<b>TH15023</b>	5F	F33	1610	42	92,98	91,61	97	-	70	45,0	25,0	20,0	1,3
		<b>24H150</b>	<b>TH15024</b>	5F	F34	1610	42	97,02	95,65	102	-	74	45,0	25,0	20,0	1,0
		<b>25H150</b>	<b>TH15025</b>	5F	F35	1610	42	101,06	99,69	106	-	77	45,0	25,0	20,0	1,2
		<b>26H150</b>	<b>TH15026</b>	5F	F36	1610	42	105,11	103,73	112	-	82	45,0	25,0	20,0	1,4
		<b>27H150</b>	<b>TH15027</b>	5F	F37	1610	42	109,15	107,78	115	-	85	45,0	25,0	20,0	1,6
		<b>28H150</b>	<b>TH15028</b>	5F	F38	1610	42	113,19	111,82	120	-	90	45,0	25,0	20,0	1,8
		<b>30H150</b>	<b>TH15030</b>	5F	F40	1610	42	121,28	119,90	128	-	98	45,0	25,0	20,0	2,3
		<b>32H150</b>	<b>TH15032</b>	5WF	F42	1610	42	129,36	127,99	135	80	106	45,0	25,0	20,0	2,3
		<b>36H150</b>	<b>TH15036</b>	5WF	F48	1610	42	145,53	144,16	150	92	121	45,0	25,0	20,0	3,1
		<b>40H150</b>	<b>TH15040</b>	5WF	F52	1610	42	161,70	160,33	168	92	138	45,0	25,0	20,0	4,0
		<b>44H150</b>	<b>TH15044</b>	5WF	F55	2012	50	177,87	176,50	184	106	152	45,0	32,0	13,0	4,4
<b>48H150</b>	<b>TH15048</b>	5WF	F59	2012	50	194,04	192,67	200	106	169	45,0	32,0	13,0	4,8		
Ghisa / Cast iron Grauguss / Fonte Hierro fundido	senza flangia without flanges ohne Flanschen sans flasques sin tapetas	<b>60H150</b>	<b>TH15060</b>	9A		2012	50	242,55	241,18	-	92	223	46,0	32,0	7,5	5,4
		<b>72H150</b>	<b>TH15072</b>	9A		2012	50	291,06	289,69	-	92	270	46,0	32,0	7,5	6,5
		<b>84H150</b>	<b>TH15084</b>	9A		2012	50	339,57	338,20	-	92	318	46,0	32,0	7,5	8,4
		<b>96H150</b>	<b>TH15096</b>	9A		2517	60	388,08	386,71	-	106	366	46,0	45,0	0,5	11,0
		<b>120H150</b>	<b>TH73120</b>	9A		2517	60	485,10	483,73	-	106	462	46,0	45,0	0,5	14,8

### H 200 - 1/2" (12,7 mm)

Caratteristiche Features Merkmal Características	Codice Code symbol Fabriknummer Code symbole Numero de fabrica	Nostro codice Our code Unser kode Notre code Nuestro codiglo	Tipo Type Typ Type Tipo	Tipo flangia Flanges type Bordscheiben Typ Type flasques Tipo tapetas	Bussola Bush Buchse Moyeu Casquillo	Foro max. Max. Bore Max. Bohrung Alesage max. Agujero max.	Dp	De	Df	Dm	Di	F	S	R	Peso Weight / Gewicht Poids / Peso Kg	
Acciaio / Steel / Stahl Acier / Acero	con flangia / with flanges mit Flanges / avec flasques / con tapetas	<b>18H200</b>	<b>TH20018</b>	5F	F28	1210	32	72,77	71,39	79	-	52	58,0	25,0	33,0	0,8
		<b>19H200</b>	<b>TH20019</b>	5F	F29	1210	32	76,81	75,44	83	-	56	58,0	25,0	33,0	0,9
		<b>20H200</b>	<b>TH20020</b>	5F	F30	1610	42	80,55	79,48	87	-	60	58,0	25,0	33,0	1,0
		<b>21H200</b>	<b>TH20021</b>	5F	F31	1610	42	84,89	83,52	91	-	64	58,0	25,0	33,0	1,7
		<b>22H200</b>	<b>TH20022</b>	5F	F32	1610	42	88,94	87,56	93	-	67	58,0	25,0	33,0	1,5
		<b>23H200</b>	<b>TH20023</b>	5F	F33	1610	42	92,98	91,61	97	-	70	58,0	25,0	33,0	1,8
		<b>24H200</b>	<b>TH20024</b>	5F	F34	1610	42	97,02	95,65	102	-	74	58,0	25,0	33,0	1,5
		<b>25H200</b>	<b>TH20025</b>	5F	F35	1610	42	101,06	99,69	106	-	77	58,0	25,0	33,0	1,5
		<b>26H200</b>	<b>TH20026</b>	5F	F36	1610	42	105,11	103,73	112	-	82	58,0	25,0	33,0	1,8
		<b>27H200</b>	<b>TH20027</b>	5F	F37	1610	42	109,15	107,78	115	-	85	58,0	25,0	33,0	1,9
		<b>28H200</b>	<b>TH20028</b>	5F	F38	1610	42	113,19	111,82	120	-	90	58,0	25,0	33,0	1,9
		<b>30H200</b>	<b>TH20030</b>	5F	F40	1610	42	121,28	119,90	128	-	98	58,0	25,0	33,0	2,3
		<b>32H200</b>	<b>TH20032</b>	5F	F42	2012	50	129,36	127,99	135	-	106	58,0	32,0	26,0	3,0
		<b>36H200</b>	<b>TH20036</b>	5WF	F48	2012	50	145,53	144,16	150	102	121	58,0	32,0	26,0	3,0
		<b>40H200</b>	<b>TH20040</b>	5WF	F52	2012	50	161,70	160,33	168	106	140	58,0	32,0	26,0	3,6
		<b>44H200</b>	<b>TH20044</b>	5WF	F55	2012	50	177,87	176,50	184	106	150	58,0	32,0	26,0	4,0
<b>48H200</b>	<b>TH20048</b>	5WF	F59	2517	60	194,04	192,67	200	119	168	58,0	45,0	13,0	4,6		
Ghisa / Cast iron Grauguss / Fonte Hierro fundido	senza flangia without flanges ohne Flanschen sans flasques sin tapetas	<b>60H200</b>	<b>TH20060</b>	9A		2517	60	242,55	241,18	-	119	223	60,0	45,0	7,5	7,0
		<b>72H200</b>	<b>TH20072</b>	9A		2517	60	291,06	289,69	-	119	270	60,0	45,0	7,5	8,0
		<b>84H200</b>	<b>TH20084</b>	9A		2517	60	339,57	338,20	-	119	318	60,0	45,0	7,5	9,0
		<b>96H200</b>	<b>TH20096</b>	9A		2517	60	388,08	386,71	-	119	366	60,0	45,0	7,5	10,0
		<b>120H200</b>	<b>TH20120</b>	9A		2517	60	485,10	483,73	-	119	462	60,0	45,0	7,5	13,4

### H 300 - 1/2" (12,7 mm)

Caratteristiche Features Merkmal Características	Codice Code symbol Fabriknummer Code symbole Numero de fabrica	Nostro codice Our code Unser kode Notre code Nuestro codiglo	Tipo Type Typ Type Tipo	Tipo flangia Flanges type Bordscheiben Typ Type flasques Tipo tapetas	Bussola Bush Buchse Moyeu Casquillo	Foro max. Max. Bore Max. Bohrung Alesage max. Agujero max.	Dp	De	Df	Dm	Di	F	S	R	Peso Weight / Gewicht Poids / Peso Kg	
Acciaio / Steel / Stahl Acier / Acero	con flangia / with flanges mit Flanges / avec flasques / con tapetas	<b>20H300</b>	<b>TH30020</b>	4F	F31	1615	42	80,85	79,48	87	-	65	84,0	38,0	23,0	1,5
		<b>21H300</b>	<b>TH30021</b>	4F	F31	1615	42	84,89	83,52	91	-	65	84,0	38,0	23,0	1,2
		<b>22H300</b>	<b>TH30022</b>	4F	F32	1615	42	88,94	87,56	93	-	67	84,0	38,0	23,0	1,6
		<b>23H300</b>	<b>TH30023</b>	4F	F33	1615	42	92,98	91,61	97	-	70	84,0	38,0	23,0	1,8
		<b>24H300</b>	<b>TH30024</b>	4F	F34	1615	42	97,02	95,65	102	-	74	84,0	38,0	23,0	2,0
		<b>25H300</b>	<b>TH30025</b>	4F	F35	1615	42	101,06	99,69	106	-	77	84,0	38,0	23,0	2,0
		<b>26H300</b>	<b>TH30026</b>	4F	F36	1615	42	105,11	103,73	112	-	82	84,0	38,0	23,0	2,7
		<b>27H300</b>	<b>TH30027</b>	4F	F37	2012	50	109,15	107,78	115	-	85	84,0	32,0	26,0	3,0
		<b>28H300</b>	<b>TH30028</b>	4F	F38	2012	50	113,19	111,82	120	-	90	84,0	32,0	26,0	2,4
		<b>30H300</b>	<b>TH30030</b>	4F	F40	2012	50	121,28	119,90	128	-	98	84,0	32,0	26,0	2,9
		<b>32H300</b>	<b>TH30032</b>	4F	F42	2517	60	129,36	127,99	135	-	106	84,0	45,0	19,5	3,3
		<b>36H300</b>	<b>TH30036</b>	4F	F48	2517	60	145,53	144,16	150	-	121	84,0	45,0	19,5	4,5
		<b>40H300</b>	<b>TH30040</b>	4F	F52	2517	60	161,70	160,33	168	-	138	84,0	45,0	19,5	6,0
		<b>44H300</b>	<b>TH30044</b>	4WF	F55	2517	60	177,87	176,50	184	119	150	86,0	45,0	20,5	6,6
		<b>48H300</b>	<b>TH30048</b>	4WF	F59	2517	60	194,04	192,67	200	119	168	86,0	45,0	20,5	7,6
		Ghisa / Cast iron Grauguss / Fonte Hierro fundido	senza flangia without flanges ohne Flanschen sans flasques sin tapetas	<b>60H300</b>	<b>TH30060</b>	9A		2517	60	242,55	241,18	-	119	223	86,0	45,0
<b>72H300</b>	<b>TH30072</b>			9A		2517	60	291,06	289,69	-	119	270	86,0	45,0	20,5	10,4
<b>84H300</b>	<b>TH30084</b>			9A		2517	60	339,57	338,20	-	119	318	86,0	45,0	20,5	12,5
<b>96H300</b>	<b>TH30096</b>			9A		3030	75	388,08	386,71	-	150	366	86,0	76,0	5,0	14,2
<b>120H300</b>	<b>TH30120</b>			9A		3030	75	485,10	483,73	-	150	462	86,0	76,0	5,0	18,8

**Pulegge dentate per bussola conica / Timing belt pulleys for taper bushes**  
**Zahnriemenscheiben für Spannbüchsen / Poulies dentées à moyeu amovible**  
**Poleas dentadas para casquillos cónicos (taper)**



**XH 200 - 7/8" (22,225 mm)**

Caratteristiche Features Merkmale Características	Codice Code symbol Fabriknummer Code symbole Numero de fabrica	Nostro codice Our code Unser kode Notre code Nuestro codiggo	Tipo Type Typ Type Tipo	Tipo flangia Flanges type Bordscheiben Typ Type flasques Tipo tapetas	Bussola Bush Buchse Moyeu Casquillo	Foro max. Max. Bore Max. Bohrung Alesage max. Agujero max.	Dp	De	Df	Dm	Di	F	S	R	Peso Weight / Gewicht Poids / Peso Kg
Ghisa / Cast iron Grauguss / Fonte Hierro fundido	con flangia / with flanges mit Flanges / avec flasques / con tapetas	<b>18XH200</b>	<b>TXH2018</b>	5F	F44	2517	60	127,34	124,55	140	-	95	64	45	19,0
		<b>20XH200</b>	<b>TXH2020</b>	5F	F49	2517	60	141,49	138,69	154	-	110	64	45	19,0
		<b>22XH200</b>	<b>TXH2022</b>	5F	F52	2517	60	155,64	152,84	168	-	120	64	45	19,0
		<b>24XH200</b>	<b>TXH2024</b>	5F	F55	2517	60	169,79	166,99	184	-	135	64	45	19,0
		<b>26XH200</b>	<b>TXH2026</b>	5F	F59	2517	60	183,94	181,14	200	-	150	64	45	19,0
		<b>28XH200</b>	<b>TXH2028</b>	4WF	F61	2517	60	198,08	195,29	212	120	165	64	45	9,5
		<b>30XH200</b>	<b>TXH2030</b>	4WF	F62	2517	60	212,23	209,44	226	120	180	64	45	9,5
		<b>32XH200</b>	<b>TXH2032</b>	4WF	F64	2517	60	226,38	223,59	240	120	195	64	45	9,5
		<b>40XH200</b>	<b>TXH2040</b>	4WF	F70	3020	75	282,98	280,18	296	160	245	64	51	9,5
	senza flangia / without flanges ohne Flanschen / sans flasques sin tapetas	<b>48XH200</b>	<b>TXH2048</b>	9W		3020	75	339,57	336,78	-	160	300	64	51	6,5
		<b>60XH200</b>	<b>TXH2060</b>	7A		3535	90	424,47	421,67	-	190	385	64	89	12,5
		<b>72XH200</b>	<b>TXH2072</b>	7A		3535	90	509,40	506,56	-	190	470	64	89	12,5
		<b>84XH200</b>	<b>TXH2084</b>	7A		3535	90	594,25	591,46	-	190	555	64	89	12,5
		<b>96XH200</b>	<b>TXH2096</b>	7A		3535	90	679,15	676,35	-	190	640	64	89	12,5
		<b>120XH200</b>	<b>TXH2120</b>	7A		3535	90	848,93	846,14	-	190	810	64	89	12,5

**H 300 - 1/2" (12,7 mm)**

Caratteristiche Features Merkmale Características	Codice Code symbol Fabriknummer Code symbole Numero de fabrica	Nostro codice Our code Unser kode Notre code Nuestro codiggo	Tipo Type Typ Type Tipo	Tipo flangia Flanges type Bordscheiben Typ Type flasques Tipo tapetas	Bussola Bush Buchse Moyeu Casquillo	Foro max. Max. Bore Max. Bohrung Alesage max. Agujero max.	Dp	De	Df	Dm	Di	F	S	R	Peso Weight / Gewicht Poids / Peso Kg
Ghisa / Cast iron Grauguss / Fonte Hierro fundido	con flangia / with flanges mit Flanges / avec flasques / con tapetas	<b>18XH300</b>	<b>TXH3018</b>	5F	F44	2517	60	127,34	124,55	140	-	95	90	45	45,0
		<b>20XH300</b>	<b>TXH3020</b>	5F	F49	2517	60	141,49	138,69	154	-	110	90	45	45,0
		<b>22XH300</b>	<b>TXH3022</b>	5F	F52	2517	60	155,64	152,84	168	-	120	90	45	45,0
		<b>24XH300</b>	<b>TXH3024</b>	5F	F55	2517	60	169,79	166,99	184	-	135	90	45	45,0
		<b>26XH300</b>	<b>TXH3026</b>	5F	F59	2517	60	183,94	181,14	200	-	150	90	45	45,0
		<b>28XH300</b>	<b>TXH3028</b>	5F	F61	3020	75	198,08	195,29	212	120	165	90	51	39,0
		<b>30XH300</b>	<b>TXH3030</b>	5F	F62	3020	75	212,23	209,44	226	120	180	90	51	39,0
		<b>32XH300</b>	<b>TXH3032</b>	5F	F64	3020	75	226,38	223,59	240	120	195	90	51	39,0
		<b>40XH300</b>	<b>TXH3040</b>	4WF	F70	3020	75	282,98	280,18	296	160	245	90	51	19,5
	senza flangia / without flanges ohne Flanschen / sans flasques sin tapetas	<b>48XH300</b>	<b>TXH3048</b>	9A		3020	75	339,57	336,78	-	160	300	90	51	19,5
		<b>60XH300</b>	<b>TXH3060</b>	9A		3535	90	424,47	421,67	-	190	385	90	89	0,5
		<b>72XH300</b>	<b>TXH3072</b>	9A		3535	90	509,40	506,56	-	190	470	90	89	0,5
		<b>84XH300</b>	<b>TXH3084</b>	7A		4040	100	594,25	591,46	-	190	555	90	102	6,0
		<b>96XH300</b>	<b>TXH3096</b>	7A		4040	100	679,15	676,35	-	190	640	90	102	6,0
		<b>120XH300</b>	<b>TXH3120</b>	7A		4040	100	848,93	846,14	-	190	810	90	102	6,0

**XH 400 - 7/8" (22,225 mm)**

Caratteristiche Features Merkmale Características	Codice Code symbol Fabriknummer Code symbole Numero de fabrica	Nostro codice Our code Unser kode Notre code Nuestro codigo	Tipo Type Typ Type Tipo	Tipo flangia Flanges type Bordscheiben Typ Type flasques Tipo tapetas	Bussola Bush Buchse Moyeu Casquillo	Foro max. Max. Bore Max. Bohrung Alesage max. Agujero max.	Dp	De	Df	Dm	Di	F	S	R	Peso Weight / Gewicht Poids / Peso Kg
Ghisa / Cast iron Grauguss / Fonte Hierro fundido	con flangia / with flanges mit Flanges / avec flasques / con tapetas	<b>18XH400</b>	<b>TXH4018</b>	5F	F44	2517	60	127,34	124,55	140	-	95	119	45	74,0
		<b>20XH400</b>	<b>TXH4020</b>	5F	F49	2517	60	141,49	138,69	154	-	110	119	45	74,0
		<b>22XH400</b>	<b>TXH4022</b>	5F	F52	2517	60	155,64	152,84	168	-	120	119	45	74,0
		<b>24XH400</b>	<b>TXH4024</b>	5F	F55	3020	75	169,79	166,99	184	-	135	119	51	68,0
		<b>26XH400</b>	<b>TXH4026</b>	5F	F59	3020	75	183,94	181,14	200	-	150	119	51	68,0
		<b>28XH400</b>	<b>TXH4028</b>	5F	F61	3020	75	198,08	195,29	212	120	165	119	51	68,0
		<b>30XH400</b>	<b>TXH4030</b>	5F	F62	3020	75	212,23	209,44	226	120	180	119	51	68,0
		<b>32XH400</b>	<b>TXH4032</b>	5F	F64	3020	75	226,38	223,59	240	120	195	119	51	68,0
		<b>40XH400</b>	<b>TXH4040</b>	4WF	F70	3535	90	282,98	280,18	296	160	245	119	89	15,0
	senza flangia / without flanges ohne Flanschen / sans flasques sin tapetas	<b>48XH400</b>	<b>TXH4048</b>	9W		3535	90	339,57	336,78	-	160	300	119	89	15,0
		<b>60XH400</b>	<b>TXH4060</b>	9A		4040	100	424,47	421,67	-	190	385	119	102	8,5
		<b>72XH400</b>	<b>TXH4072</b>	9A		4040	100	509,40	506,56	-	190	470	119	102	8,5
		<b>84XH400</b>	<b>TXH4084</b>	9A		4040	100	594,25	591,46	-	190	555	119	102	8,5
		<b>96XH400</b>	<b>TXH4096</b>	9A		4040	100	679,15	676,35	-	190	640	119	102	8,5
		<b>120XH400</b>	<b>TXH4120</b>	9A		4040	100	848,93	846,14	-	190	810	119	102	8,5

**Pulegge dentate per cinghie passo metrico**  
**Timing belt pulleys metric pitch**  
**Zahnriemenscheiben metrische teilung**  
**Poulies dentées pour courroies pas métrique**  
**Poleas dentadas para correas con paso metrico**

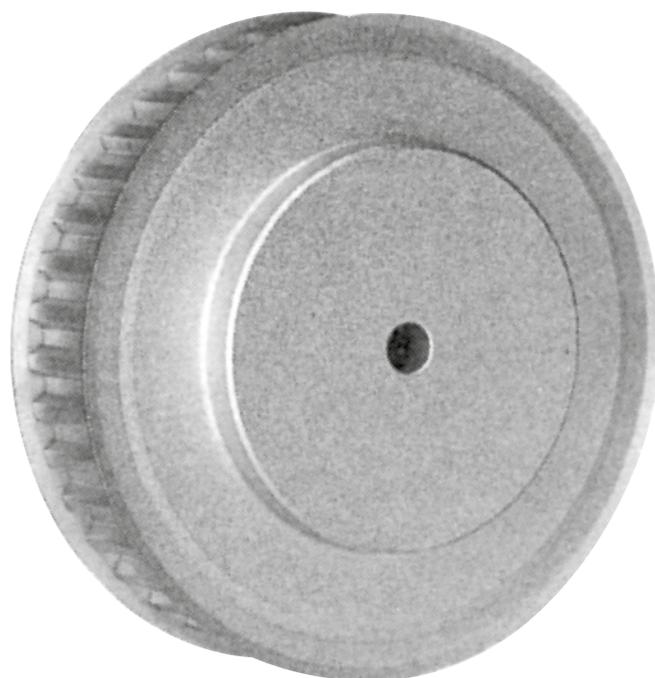

# Istruzioni per l'identificazione e la classificazione delle pulegge a passo metrico

## Instructions for the identification and classification of timing belt pulleys metric pitch

### Leitfaden zur suche und Klassifizierung der Zahnriemenscheiben metrische Teilung

#### Instructions pour la recherche et la classification des poulies dentées pas métrique

#### Guia a la busca y clasificación de las poleas dentadas en paso metrico

**Esempio:**  
ALTEZZA 40 T 10/32-2

**40** = Larghezza totale della puleggia 40 mm (L)  
**T10** = Passo 10 mm  
**30** = N. denti  
**2** = N. della flangia

**Example:**  
PULLEY 40 T 10/32-2

**40** = Total width of pulley 40 mm (L)  
**T10** = Pitch 10 mm  
**30** = No. of teeth  
**2** = No. of flanges

**Beispiel:**  
SCHIBE 40 T 10/32-2

**40** = Gesamtbreite der Scheibe 40 mm (L)  
**T10** = Teilung 10 mm  
**30** = Zähnezahl  
**2** = Anzahl der Bordscheiben

**Exemple:**  
POULIE 40 T 10/32-2

**40** = Largeur totale de la poulie 40 mm (L)  
**T10** = Pas 10 mm  
**30** = N. de dents  
**2** = N. de flasques

**Ejemplo:**  
POLEA 40 T 10/32-2

**40** = Ancho total de la polea 40 mm (L)  
**T10** = Paso 10 mm  
**30** = Cantidad de dientes  
**2** = Cantidad de tapetas

**Materiale:**  
alluminio 6082 T6  
UNI 9006/4 adatto al trattamento anodico

**Material:**  
aluminium 6082 T6 UNI 9006/4 suitable for anodic treatment

**Werkstoff:**  
aluminium 6082 T6 UNI 9006/4 geeignet für anodischen oxydation

**Matière:**  
aluminium 6082 T6 UNI 9006/4 apte au traitement anodique

**Material:**  
aluminio 6082 T6 UNI 9006/4 apto para la oxidacion anodica

## Pulegge dentate per cinghie passo metrico / Timing belt pulleys metric pitch

### Zahnriemenscheiben metrische Teilung / Poulies dentées pour courroies pas métrique

#### Poleas dentadas para correas con paso metrico

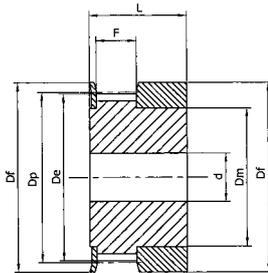

**Tipo / Type**  
**1F**

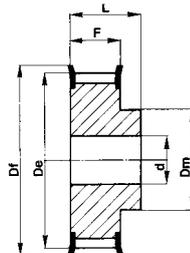

**Tipo / Type**  
**6F**

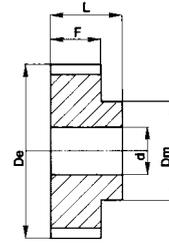

**Tipo / Type**  
**6**

## T 2,5

(Paso 2,5 mm)  
per cinghia larghezza 6 mm

(Pitch 2,5 mm)  
for belt width 6 mm

(Teilung 2,5 mm)  
für Riemenbreite 6 mm

(Pas 2,5 mm)  
pour courroies largeur 6 mm

(Paso 2,5 mm)  
para correas ancho 6 mm

Code symbol / Fabriknummer Code symbole / Numero de fabrica	Nostro codice Our code / Unser kode Notre code / Nuestro codigo	Tipo Type / Typ Type / Tipo	Tipo flangia Flanges type / Bordscheiben Typ Type flasques / Tipo tapetas	N. denti N. of teeth / Zähnezahl N. bre de dents / Cantidad de dientes	Dp	De	Df	Dm	F	L	d	Peso / Weight Gewicht / Poids / Peso Kg
16T2,5/12-2	16T2012	1F	F01	12	9,60	9,00	13,0	6,0	9	16	4	0,004
16T2,5/14-2	16T2014	1F	F02	14	11,20	10,60	15,0	8,0	9	16	4	0,006
16T2,5/15-2	16T2015	1F	F02	15	12,00	11,40	15,0	8,0	9	16	4	0,006
16T2,5/16-2	16T2016	1F	F03	16	12,80	12,20	16,0	9,5	9	16	4	0,006
16T2,5/18-2	16T2018	6F	F04	18	14,40	13,80	17,5	10,0	10	16	4	0,006
16T2,5/19-2	16T2019	6F	F05	19	15,20	14,60	18,0	10,0	10	16	4	0,007
16T2,5/20-2	16T2020	6F	F06	20	16,00	15,40	20,0	10,5	10	16	4	0,008
16T2,5/22-2	16T2022	6F	F07	22	17,60	17,00	23,0	11,0	10	16	4	0,010
16T2,5/24-2	16T2024	6F	F07	24	19,15	18,55	23,0	12,0	10	16	4	0,012
16T2,5/25-2	16T2025	6F	F07	25	19,95	19,35	23,0	13,0	10	16	4	0,013
16T2,5/26-2	16T2026	6F	F09	26	20,75	20,15	25,0	14,0	10	16	4	0,015
16T2,5/28-2	16T2028	6F	F09	28	22,35	21,75	25,0	14,0	10	16	4	0,016
16T2,5/30-2	16T2030	6F	F09	30	23,95	23,35	28,0	16,0	10	16	6	0,018
16T2,5/32-2	16T2032	6F	F10	32	25,95	24,95	32,0	16,0	10	16	6	0,020
16T2,5/36-2	16T2036	6F	F12	36	28,75	28,10	36,0	20,0	10	16	6	0,026
16T2,5/40-2	16T2040	6F	F14	40	31,90	31,30	38,0	22,0	10	16	6	0,032
16T2,5/44-0	16T2044	6F	F15	44	35,10	34,50	42,0	24,0	10	16	6	0,038
16T2,5/48-0	16T2048	6	-	48	38,30	37,70	-	26,0	10	16	6	0,048
16T2,5/60-0	16T2060	6	-	60	47,85	47,25	-	34,0	10	16	8	0,073

Per pulegge aventi un numero di denti diverso dalla tabella, consultateci.

For pulleys with a number of teeth not included in these tables please ask for our quotation.

Verlangen sie angebot für Zahnscheiben mit Anzahl von Zähnen die nicht in diesen Tafeln aufgefuehrt sind.

Pour les poulies avec un nombre de dents different du tableau, nous consulter.

Pidan oferta por lo que concierne una cantidad de dientes no incluida en estas tablas.



**Pulegge dentate per cinghie passo metrico / Timing belt pulleys metric pitch**  
**Zahnriemenscheiben metrische Teilung / Poulies dentées pour courroies pas métrique**  
**Poleas dentadas para correas con paso metrico**



**Materiale:** alluminio 6082 T6 UNI 9006/4 adatto al trattamento anodico  
**Material:** aluminium 6082 T6 UNI 9006/4 suitable for anodic treatment  
**Werkstoff:** aluminium 6082 T6 UNI 9006/4 geeignet für anodischen oxydation  
**Matière:** aluminium 6082 T6 UNI 9006/4 apte au traitement anodique  
**Material:** aluminio 6082 T6 UNI 9006/4 apto para la oxidacion anodica

**Tipo / Type**  
**6F**

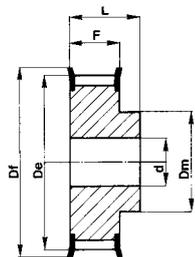

**Tipo / Type**  
**6**

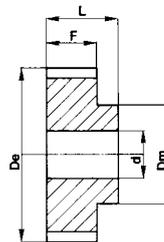

**T 5**

(Passo 5 mm) per cinghia larghezza 10 mm (Pitch 5 mm) for belt width 10 mm (Teilung 5 mm) für Riemenbreite 10 mm (Pas 5 mm) pour courroies largeur 10 mm (Paso 5 mm) para correas ancho 10 mm

Code symbol / Fabriknummer / Code symbole / Numero de fabrica	Nostro codice / Our code / Unser kode / Notre code / Nuestro codigo	Tipo / Type / Typ / Type	Tipo flangia / Flanges type / Bordscheiben Typ / Type flasques / Tipo tapetas	N. denti / N. of teeth / Zahnezahl / N. bre de dents / Cantidad de dientes	Dp	De	Df	Dm	F	L	d	Peso / Weight / Gewicht / Poids / Peso / Kg
21T5/10-2	21T5010	6F	F06	10	16,05	15,05	20,0	8	15	21	4	0,012
21T5/12-2	21T5012	6F	F07	12	19,25	18,25	23,0	11	15	21	4	0,016
21T5/14-2	21T5014	6F	F08	14	22,45	21,45	25,0	13	15	21	4	0,019
21T5/15-2	21T5015	6F	F09	15	24,05	23,05	28,0	16	15	21	6	0,021
21T5/16-2	21T5016	6F	F10	16	25,06	24,60	32,0	18	15	21	6	0,025
21T5/18-2	21T5018	6F	F10	18	28,80	27,80	32,0	20	15	21	6	0,031
21T5/19-2	21T5019	6F	F12	19	30,40	29,40	36,0	22	15	21	6	0,036
21T5/20-2	21T5020	6F	F12	20	32,00	31,00	36,0	23	15	21	6	0,038
21T5/22-2	21T5022	6F	F14	22	35,15	34,15	38,0	24	15	21	6	0,054
21T5/24-2	21T5024	6F	F15	24	38,40	37,40	42,0	26	15	21	6	0,056
21T5/25-2	21T5025	6F	F17	25	39,95	38,95	44,0	26	15	21	6	0,058
21T5/26-2	21T5026	6F	F17	26	41,60	40,60	44,0	26	15	21	6	0,064
21T5/27-2	21T5027	6F	F18	27	43,20	42,20	48,0	30	15	21	8	0,070
21T5/28-2	21T5028	6F	F18	28	44,75	43,75	48,0	32	15	21	8	0,075
21T5/30-2	21T5030	6F	F19	30	47,95	46,95	51,0	34	15	21	8	0,081
21T5/32-2	21T5032	6F	F20	32	51,10	50,10	54,0	38	15	21	8	0,088
21T5/36-2	21T5036	6F	F24	36	57,45	56,45	64,0	38	15	21	8	0,114
21T5/40-2	21T5040	6F	F25	40	63,85	62,85	66,0	40	15	21	8	0,138
21T5/42-2	21T5042	6F	F26	42	67,00	66,00	70,0	40	15	21	8	0,165
21T5/44-0	21T5044	6	-	44	70,20	69,20	-	45	15	21	8	0,200
21T5/48-0	21T5048	6	-	48	76,55	75,55	-	50	15	21	8	0,307
21T5/60-0	21T5060	6	-	60	95,65	94,65	-	65	15	21	8	0,180

(Passo 5 mm) per cinghia larghezza 16 mm (Pitch 5 mm) for belt width 16 mm (Teilung 5 mm) für Riemenbreite 16 mm (Pas 5 mm) pour courroies largeur 16 mm (Paso 5 mm) para correas ancho 16 mm

Code symbol / Fabriknummer / Code symbole / Numero de fabrica	Nostro codice / Our code / Unser kode / Notre code / Nuestro codigo	Tipo / Type / Typ / Type	Tipo flangia / Flanges type / Bordscheiben Typ / Type flasques / Tipo tapetas	N. denti / N. of teeth / Zahnezahl / N. bre de dents / Cantidad de dientes	Dp	De	Df	Dm	F	L	d	Peso / Weight / Gewicht / Poids / Peso / Kg
27T5/10-2	27T5010	6F	F06	10	16,05	15,05	20,0	8	21	27	4	0,016
27T5/12-2	27T5012	6F	F07	12	19,25	18,25	23,0	11	21	27	4	0,022
27T5/14-2	27T5014	6F	F08	14	22,45	21,45	25,0	13	21	27	4	0,026
27T5/15-2	27T5015	6F	F09	15	24,05	23,05	28,0	16	21	27	6	0,029
27T5/16-2	27T5016	6F	F10	16	25,06	24,60	32,0	18	21	27	6	0,035
27T5/18-2	27T5018	6F	F10	18	28,80	27,80	32,0	20	21	27	6	0,043
27T5/19-2	27T5019	6F	F12	19	30,40	29,40	36,0	22	21	27	6	0,049
27T5/20-2	27T5020	6F	F12	20	32,00	31,00	36,0	23	21	27	6	0,053
27T5/22-2	27T5022	6F	F14	22	35,15	34,15	38,0	24	21	27	6	0,062
27T5/24-2	27T5024	6F	F15	24	38,40	37,40	42,0	26	21	27	6	0,076
27T5/25-2	27T5025	6F	F17	25	39,95	38,95	44,0	26	21	27	6	0,081
27T5/26-2	27T5026	6F	F17	26	41,60	40,60	44,0	26	21	27	6	0,085
27T5/27-2	27T5027	6F	F18	27	43,20	42,20	48,0	30	21	27	8	0,090
27T5/28-2	27T5028	6F	F18	28	44,75	43,75	48,0	32	21	27	8	0,095
27T5/30-2	27T5030	6F	F19	30	47,95	46,95	51,0	34	21	27	8	0,105
27T5/32-2	27T5032	6F	F20	32	51,10	50,10	54,0	38	21	27	8	0,123
27T5/36-2	27T5036	6F	F24	36	57,45	56,45	64,0	38	21	27	8	0,160
27T5/40-2	27T5040	6F	F25	40	63,85	62,85	66,0	40	21	27	8	0,193
27T5/42-2	27T5042	6F	F26	42	67,00	66,00	70,0	40	21	27	8	0,245
27T5/44-0	27T5044	6	-	44	70,20	69,20	-	45	21	27	8	0,280
27T5/48-0	27T5048	6	-	48	76,55	75,55	-	50	21	27	8	0,430
27T5/60-0	27T5060	6	-	60	95,65	94,65	-	65	21	27	8	0,108

(Passo 5 mm) per cinghia larghezza 25 mm (Pitch 5 mm) for belt width 25 mm (Teilung 5 mm) für Riemenbreite 25 mm (Pas 5 mm) pour courroies largeur 25 mm (Paso 5 mm) para correas ancho 25 mm

Code symbol / Fabriknummer / Code symbole / Numero de fabrica	Nostro codice / Our code / Unser kode / Notre code / Nuestro codigo	Tipo / Type / Typ / Type	Tipo flangia / Flanges type / Bordscheiben Typ / Type flasques / Tipo tapetas	N. denti / N. of teeth / Zahnezahl / N. bre de dents / Cantidad de dientes	Dp	De	Df	Dm	F	L	d	Peso / Weight / Gewicht / Poids / Peso / Kg
36T5/10-2	36T5010	6F	F06	10	16,05	15,05	20,0	8	30	36	4	0,023
36T5/12-2	36T5012	6F	F07	12	19,25	18,25	23,0	11	30	36	4	0,031
36T5/14-2	36T5014	6F	F08	14	22,45	21,45	25,0	13	30	36	4	0,037
36T5/15-2	36T5015	6F	F09	15	24,05	23,05	28,0	16	30	36	6	0,041
36T5/16-2	36T5016	6F	F10	16	25,06	24,60	32,0	18	30	36	6	0,050
36T5/18-2	36T5018	6F	F10	18	28,80	27,80	32,0	20	30	36	6	0,061
36T5/19-2	36T5019	6F	F12	19	30,40	29,40	36,0	22	30	36	6	0,070
36T5/20-2	36T5020	6F	F12	20	32,00	31,00	36,0	23	30	36	6	0,076
36T5/22-2	36T5022	6F	F14	22	35,15	34,15	38,0	24	30	36	6	0,092
36T5/24-2	36T5024	6F	F15	24	38,40	37,40	42,0	26	30	36	8	0,109
36T5/25-2	36T5025	6F	F17	25	39,95	38,95	44,0	26	30	36	8	0,116
36T5/26-2	36T5026	6F	F17	26	41,60	40,60	44,0	26	30	36	8	0,121
36T5/27-2	36T5027	6F	F18	27	43,20	42,20	48,0	30	30	36	8	0,128
36T5/28-2	36T5028	6F	F18	28	44,75	43,75	48,0	32	30	36	8	0,142
36T5/30-2	36T5030	6F	F19	30	47,95	46,95	51,0	34	30	36	8	0,150
36T5/32-2	36T5032	6F	F20	32	51,10	50,10	54,0	38	30	36	8	0,176
36T5/36-2	36T5036	6F	F24	36	57,45	56,45	64,0	38	30	36	8	0,230
36T5/40-2	36T5040	6F	F25	40	63,85	62,85	66,0	40	30	36	8	0,276
36T5/42-2	36T5042	6F	F26	42	67,00	66,00	70,0	40	30	36	8	0,352
36T5/44-0	36T5044	6	-	44	70,20	69,20	-	45	30	36	8	0,400
36T5/48-0	36T5048	6	-	48	76,55	75,55	-	50	30	36	8	0,614
36T5/60-0	36T5060	6	-	60	95,65	94,65	-	65	30	36	8	0,180

# Pulegge dentate per cinghie passo metrico / Timing belt pulleys metric pitch Zahnriemenscheiben metrische Teilung / Poulies dentées pour courroies pas métrique Poleas dentadas para correas con paso metrico

**Materiale:**  
alluminio 6082 T6 UNI  
9006/4 adatto al trattamento  
anodico

**Material:**  
aluminium 6082 T6 UNI  
9006/4 suitable for anodic  
treatment

**Werkstoff:**  
aluminium 6082 T6 UNI  
9006/4 geeignet für  
anodischen oxydation

**Matière:**  
aluminium 6082 T6 UNI  
9006/4 apte au traitement  
anodique

**Material:**  
aluminio 6082 T6 UNI  
9006/4 apto para la  
oxidacion anodica

**Tipo / Type**  
**6F**

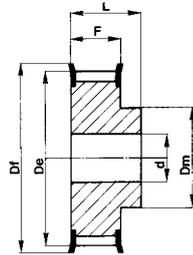

**Tipo / Type**  
**6**

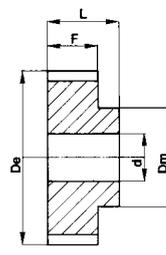

## T 10

(Passo 10 mm)  
per cinghia larghezza 16 mm

(Pitch 10 mm)  
for belt width 16 mm

(Teilung 10 mm)  
für Riemenbreite 16 mm

(Pas 10 mm)  
pour courroies largeur 16 mm

(Paso 10 mm)  
para correas ancho 16 mm

Codice Code symbol / Fabriknummer Code symbole / Numero de fabrica	Nostro codice Our code / Unser kode Notre code / Nuestro codigo	Tipo Type / Typ Type / Tipo	Tipo flangia Flanges type / Bordscheiben Typ Type flasques / Tipo tapetas	N. denti N. of teeth / Zahnzahl N. bre de dents / Cantidad de dientes	Dp	De	Df	Dm	F	L	d	Peso / Weight Gewicht / Poids / Peso Kg
31T10/12-2	31T1012	6F	F15	12	38,35	36,35	42	28	21	31	6	0,076
31T10/14-2	31T1014	6F	F18	14	44,70	42,70	48	32	21	31	8	0,104
31T10/15-2	31T1015	6F	F19	15	47,90	45,90	51	32	21	31	8	0,116
31T10/16-2	31T1016	6F	F20	16	51,10	49,10	54	35	21	31	8	0,134
31T10/18-2	31T1018	6F	F22	18	57,45	55,45	60	40	21	31	8	0,167
31T10/19-2	31T1019	6F	F25	19	60,65	58,65	66	44	21	31	8	0,184
31T10/20-2	31T1020	6F	F25	20	63,80	61,80	66	46	21	31	8	0,208
31T10/22-2	31T1022	6F	F27	22	70,20	68,20	75	52	21	31	8	0,240
31T10/24-2	31T1024	6F	F29	24	76,55	74,55	83	58	21	31	8	0,288
31T10/25-2	31T1025	6F	F29	25	79,75	77,70	83	60	21	31	8	0,295
31T10/26-2	31T1026	6F	F30	26	82,90	80,90	87	60	21	31	8	0,310
31T10/27-2	31T1027	6F	F31	27	86,10	84,10	91	60	21	31	8	0,364
31T10/28-2	31T1028	6F	F32	28	89,25	87,25	93	60	21	31	8	0,441
31T10/30-2	31T1030	6F	F33	30	95,65	93,65	97	60	21	31	8	0,493
31T10/32-2	31T1032	6F	F35	32	102,00	100,00	106	65	21	31	10	0,623
31T10/36-2	31T1036	6F	F38	36	114,75	112,75	120	70	21	31	10	0,767
31T10/40-2	31T1040	6F	F41	40	127,45	125,45	131	80	21	31	10	0,950
31T10/44-0	31T1044	6	-	44	140,20	138,20	-	88	21	31	10	1,090
31T10/48-0	31T1048	6	-	48	152,95	150,95	-	95	21	31	16	1,704
31T10/60-0	31T1060	6	-	60	191,15	189,10	-	110	21	31	16	1,704

(Passo 10 mm)  
per cinghia larghezza 25 mm

(Pitch 10 mm)  
for belt width 25 mm

(Teilung 10 mm)  
für Riemenbreite 25 mm

(Pas 10 mm)  
pour courroies largeur 25 mm

(Paso 10 mm)  
para correas ancho 25 mm

40T10/12-2	40T1012	6F	F15	12	38,35	36,35	42	28	30	40	6	0,099
40T10/14-2	40T1014	6F	F18	14	44,70	42,70	48	32	30	40	8	0,134
40T10/15-2	40T1015	6F	F19	15	47,90	45,90	51	32	30	40	8	0,152
40T10/16-2	40T1016	6F	F20	16	51,10	49,10	54	35	30	40	8	0,176
40T10/18-2	40T1018	6F	F22	18	57,45	55,45	60	40	30	40	8	0,224
40T10/19-2	40T1019	6F	F25	19	60,65	58,65	66	44	30	40	8	0,247
40T10/20-2	40T1020	6F	F25	20	63,80	61,80	66	46	30	40	8	0,276
40T10/22-2	40T1022	6F	F27	22	70,20	68,20	75	52	30	40	8	0,310
40T10/24-2	40T1024	6F	F29	24	76,55	74,55	83	58	30	40	8	0,392
40T10/25-2	40T1025	6F	F29	25	79,75	77,70	83	60	30	40	8	0,422
40T10/26-2	40T1026	6F	F30	26	82,90	80,90	87	60	30	40	8	0,480
40T10/27-2	40T1027	6F	F31	27	86,10	84,10	91	60	30	40	8	0,536
40T10/28-2	40T1028	6F	F32	28	89,25	87,25	93	60	30	40	8	0,590
40T10/30-2	40T1030	6F	F33	30	95,65	93,65	97	60	30	40	8	0,640
40T10/32-2	40T1032	6F	F35	32	102,00	100,00	106	65	30	40	10	0,693
40T10/36-2	40T1036	6F	F38	36	114,75	112,75	120	70	30	40	10	0,873
40T10/40-2	40T1040	6F	F41	40	127,45	125,45	131	80	30	40	10	1,067
40T10/44-0	40T1044	6	-	44	140,20	138,20	-	88	30	40	10	1,310
40T10/48-0	40T1048	6	-	48	152,95	150,95	-	95	30	40	16	1,516
40T10/60-0	40T1060	6	-	60	191,15	189,10	-	110	30	40	16	2,339

**Pulegge dentate per cinghie passo metrico / Timing belt pulleys metric pitch**  
**Zahnriemenscheiben metrische Teilung / Poulies dentées pour courroies pas métrique**  
**Poleas dentadas para correas con paso metrico**



**Materiale:**  
**alluminio 6082 T6 UNI**  
**9006/4 adatto al trattamento**  
**anodico**

**Material:**  
**aluminium 6082 T6 UNI**  
**9006/4 suitable for anodic**  
**treatment**

**Werkstoff:**  
**aluminium 6082 T6 UNI**  
**9006/4 geeignet für**  
**anodischen oxydation**

**Matière:**  
**aluminium 6082 T6 UNI**  
**9006/4 apte au traitement**  
**anodique**

**Material:**  
**aluminio 6082 T6 UNI**  
**9006/4 apto para la**  
**oxidacion anodica**

**Tipo / Type**  
**6F**

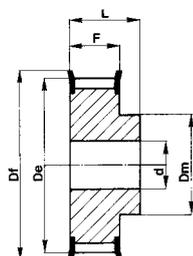

**Tipo / Type**  
**6**

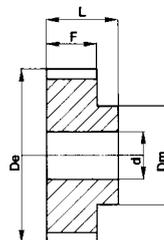

**T 10**

(Paso 10 mm)  
 per cinghia larghezza 32 mm

(Pitch 10 mm)  
 for belt width 32 mm

(Teilung 10 mm)  
 für Riemenbreite 32 mm

(Pas 10 mm)  
 pour courroies largeur 32 mm

(Paso 10 mm)  
 para correas ancho 32 mm

Codice Code symbol / Fabriknummer Code symbole / Numero de fabrica	Nostro codice Our code / Unser kode Notre code / Nuestro codigo	Tipo Type / Typ Type / Tipo	Tipo flangia Flanges type / Bordscheiben Typ Type flasques / Tipo tapetas	N. denti N. of teeth / Zahnezahl N. bre de dents / Cantidad de dientes	Dp	De	Df	Dm	F	L	d	Peso / Weight Gewicht / Poids / Peso Kg
47T10/18-2	47T1018	6F	F22	18	57,45	55,45	60	40	37	47	10	0,253
47T10/19-2	47T1019	6F	F25	19	60,65	58,65	66	44	37	47	10	0,286
47T10/20-2	47T1020	6F	F25	20	63,80	61,80	66	46	37	47	12	0,322
47T10/22-2	47T1022	6F	F27	22	70,20	68,20	75	52	37	47	12	0,393
47T10/24-2	47T1024	6F	F29	24	76,55	74,55	83	58	37	47	12	0,475
47T10/25-2	47T1025	6F	F29	25	79,75	77,70	83	60	37	47	12	0,527
47T10/26-2	47T1026	6F	F30	26	82,90	80,90	87	60	37	47	12	0,564
47T10/27-2	47T1027	6F	F31	27	86,10	84,10	91	60	37	47	12	0,602
47T10/28-2	47T1028	6F	F32	28	89,25	87,25	93	60	37	47	12	0,642
47T10/30-2	47T1030	6F	F33	30	95,65	93,65	97	60	37	47	12	0,740
47T10/32-2	47T1032	6F	F35	32	102,00	100,00	106	65	37	47	12	0,844
47T10/36-2	47T1036	6F	F38	36	114,75	112,75	120	70	37	47	16	1,063
47T10/40-2	47T1040	6F	F41	40	127,45	125,45	131	80	37	47	16	1,371
47T10/44-0	47T1044	6	-	44	140,20	138,20	-	88	37	47	16	1,611
47T10/48-0	47T1048	6	-	48	152,95	150,95	-	95	37	47	16	1,913
47T10/60-0	47T1060	6	-	60	191,10	189,10	-	110	37	47	16	3,004

(Paso 10 mm)  
 per cinghia larghezza 50 mm

(Pitch 10 mm)  
 for belt width 50 mm

(Teilung 10 mm)  
 für Riemenbreite 50 mm

(Pas 10 mm)  
 pour courroies largeur 50 mm

(Paso 10 mm)  
 para correas ancho 50 mm

66T10/18-2	66T1018	6F	F22	18	57,45	55,45	60	40	56	66	10	0,422
66T10/19-2	66T1019	6F	F25	19	60,65	58,65	66	44	56	66	10	0,466
66T10/20-2	66T1020	6F	F25	20	63,80	61,80	66	46	56	66	12	0,520
66T10/22-2	66T1022	6F	F27	22	70,20	68,20	75	52	56	66	12	0,640
66T10/24-2	66T1024	6F	F29	24	76,55	74,55	83	58	56	66	12	0,736
66T10/25-2	66T1025	6F	F29	25	79,75	77,70	83	60	56	66	12	0,766
66T10/26-2	66T1026	6F	F30	26	82,90	80,90	87	60	56	66	12	0,845
66T10/27-2	66T1027	6F	F31	27	86,10	84,10	91	60	56	66	12	0,946
66T10/28-2	66T1028	6F	F32	28	89,25	87,25	93	60	56	66	12	0,110
66T10/30-2	66T1030	6F	F33	30	95,65	93,65	97	60	56	66	12	1,169
66T10/32-2	66T1032	6F	F35	32	102,00	100,00	106	65	56	66	12	1,300
66T10/36-2	66T1036	6F	F38	36	114,75	112,75	120	70	56	66	16	1,637
66T10/40-2	66T1040	6F	F41	40	127,45	125,45	131	80	56	66	16	1,999
66T10/44-0	66T1044	6	-	44	140,20	138,20	-	88	56	66	16	2,420
66T10/48-0	66T1048	6	-	48	152,95	150,95	-	95	56	66	16	2,830
66T10/60-0	66T1060	6	-	60	191,10	189,10	-	110	56	66	16	4,366

**Pulegge dentate per cinghie passo metrico / Timing belt pulleys metric pitch**  
**Zahnriemenscheiben metrische Teilung / Poulies dentées pour courroies pas métrique**  
**Poleas dentadas para correas con paso metrico**

**Materiale:**  
Ghisa

**Material:**  
Cast iron

**Werkstoff:**  
Grauguss

**Matière:**  
Fonte

**Material:**  
Hierro fundido

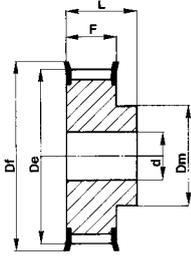

**Tipo / Type**  
**6F**

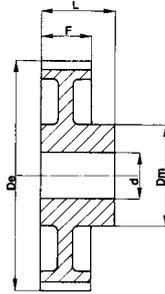

**Tipo / Type**  
**6W**

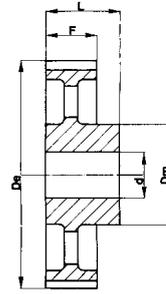

**Tipo / Type**  
**6A**

**T 20**

(Passo 20 mm)  
per cinghia larghezza 32 mm

(Pitch 20 mm)  
for belt width 32 mm

(Teilung 20 mm)  
für Riemenbreite 32 mm

(Pas 20 mm)  
pour courroies largeur 32 mm

(Paso 20 mm)  
para correas ancho 32 mm

Codice Code symbol / Fabriknummer Code symbole / Numero de fabrica	Nostro codice Our code / Unser kode Notre code / Nuestro codigo	Tipo Type / Typ Type / Tipo	Tipo flangia Flanges type / Bordscheiben Typ Type flasques / Tipo tapetas	N. denti N. of teeth / Zahnezahl N. bre de dents / Cantidad de dientes	De	Df	Dm	F	L	d	Peso / Weight Gewicht / Poids / Peso Kg
53T20/18-2	53T2018	6F	F38	18	111,75	120	80	38	53	15	
53T20/20-2	53T2020	6F	F43	20	124,50	138	90	38	53	15	
53T20/22-2	53T2022	6F	F46	22	137,20	146	90	38	53	15	
53T20/24-2	53T2024	6F	F50	24	149,95	158	95	38	53	15	
53T20/25-2	53T2025	6F	F52	25	156,30	168	95	38	53	15	
53T20/30-2	53T2030	6F	F59	30	188,15	200	110	38	53	15	
53T20/32-2	53T2032	6W		32	200,85	-	110	38	53	18	
53T20/36-2	53T2036	6W		36	226,35	-	110	38	53	18	
53T20/40-2	53T2040	6A		40	251,80	-	110	38	53	20	
53T20/48-2	53T2048	6A		48	302,70	-	130	38	53	20	
53T20/60-2	53T2060	6A		60	379,10	-	130	38	53	20	
53T20/72-2	53T2072	6A		72	455,50	-	140	38	53	20	

(Passo 20 mm)  
per cinghia larghezza 50 mm

(Pitch 20 mm)  
for belt width 50 mm

(Teilung 20 mm)  
für Riemenbreite 50 mm

(Pas 20 mm)  
pour courroies largeur 50 mm

(Paso 20 mm)  
para correas ancho 50 mm

71T20/18-2	71T2018	6F	F38	18	111,75	120	80	56	71	18	
71T20/20-2	71T2020	6F	F43	20	124,50	138	90	56	71	18	
71T20/22-2	71T2022	6F	F46	22	137,20	146	90	56	71	18	
71T20/24-2	71T2024	6F	F50	24	149,95	158	95	56	71	18	
71T20/25-2	71T2025	6F	F52	25	156,30	168	95	56	71	18	
71T20/30-2	71T2030	6F	F59	30	188,15	200	110	56	71	18	
71T20/32-2	71T2032	6W		32	200,85	-	110	56	71	20	
71T20/36-2	71T2036	6W		36	226,35	-	110	56	71	20	
71T20/40-2	71T2040	6A		40	251,80	-	110	56	71	20	
71T20/48-2	71T2048	6A		48	302,70	-	130	56	71	24	
71T20/60-2	71T2060	6A		60	379,10	-	130	56	71	24	
71T20/72-2	71T2072	6A		72	455,50	-	140	56	71	24	

(Passo 20 mm)  
per cinghia larghezza 100 mm

(Pitch 20 mm)  
for belt width 100 mm

(Teilung 20 mm)  
für Riemenbreite 100 mm

(Pas 20 mm)  
pour courroies largeur 100 mm

(Paso 20 mm)  
para correas ancho 100 mm

123T20/18-2	123T2018	6F	F38	18	111,75	120	80	108	123	24	
123T20/20-2	123T2020	6F	F43	20	124,50	138	90	108	123	24	
123T20/22-2	123T2022	6F	F46	22	137,20	146	90	108	123	24	
123T20/24-2	123T2024	6F	F50	24	149,95	158	95	108	123	24	
123T20/25-2	123T2025	6F	F52	25	156,30	168	95	108	123	24	
123T20/30-2	123T2030	6F	F59	30	188,15	200	110	108	123	24	
123T20/32-2	123T2032	6W		32	200,85	-	110	108	123	32	
123T20/36-2	123T2036	6W		36	226,35	-	110	108	123	32	
123T20/40-2	123T2040	6A		40	251,80	-	110	108	123	32	
123T20/48-2	123T2048	6A		48	302,70	-	130	108	123	32	
123T20/60-2	123T2060	6A		60	379,10	-	130	108	123	32	
123T20/72-2	123T2072	6A		72	455,50	-	140	108	123	32	

# Barre dentate standard / Standard toothed bars

## Standard Zahnriemensstagen / Barreaux dentés standard

### Barras dentadas de serie



**Materiale:**  
alluminio 6082 T6 UNI  
9006/4 adatto al trattamento  
anodico

**Material:**  
aluminium 6082 T6 UNI  
9006/4 suitable for anodic  
treatment

**Werkstoff:**  
aluminium 6082 T6 UNI  
9006/4 geeignet für  
anodischen oxydation

**Matière:**  
aluminium 6082 T6 UNI  
9006/4 apte au traitement  
anodique

**Material:**  
aluminio 6082 T6 UNI  
9006/4 apto para la  
oxidacion anodica

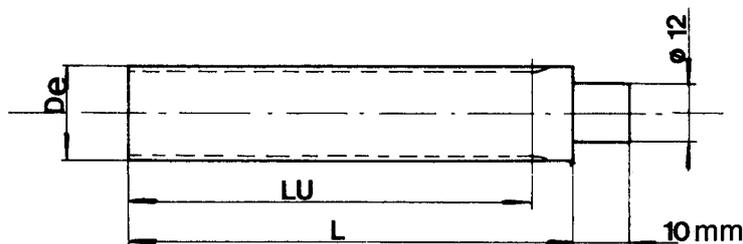

## T 2,5

(Passo 2,5 mm) / (Pitch 2,5 mm) / (Teilung 2,5 mm)  
(Pas 2,5 mm) / (Paso 2,5 mm)

## T 5

(Passo 5 mm) / (Pitch 5 mm) / (Teilung 5 mm)  
(Pas 5 mm) / (Paso 5 mm)

## T 10

(Passo 10 mm) / (Pitch 10 mm) / (Teilung 10 mm)  
(Pas 10 mm) / (Paso 10 mm)

Codice Code symbol Fabriknummer Code symbole Numero de fabrica	Nostro codice Our code Unser kode Notre code Nuestro codigo	N. denti N. of teeth Zahnezahl N. bre de dents Cantidad de dientes	De	Lu	L
T2,5-10	BT25010	10	7,42	50	75
T2,5-12	BT25012	12	9,00	50	75
T2,5-13	BT25013	13	9,80	50	75
T2,5-14	BT25014	14	10,60	50	75
T2,5-15	BT25015	15	11,40	50	75
T2,5-16	BT25016	16	12,20	50	75
T2,5-17	BT25017	17	13,00	50	75
T2,5-18	BT25018	18	13,80	50	75
T2,5-19	BT25019	19	14,60	90	120
T2,5-20	BT25020	20	15,40	90	120
T2,5-21	BT25021	21	16,20	90	120
T2,5-22	BT25022	22	17,00	125	140
T2,5-24	BT25024	24	18,55	125	140
T2,5-26	BT25026	26	20,15	125	140
T2,5-27	BT25027	27	20,95	125	140
T2,5-28	BT25028	28	21,75	125	140
T2,5-29	BT25029	29	22,55	125	140
T2,5-30	BT25030	30	23,35	125	140
T2,5-32	BT25032	32	24,95	125	140
T2,5-34	BT25034	34	26,55	125	140
T2,5-35	BT25035	35	27,35	132	140
T2,5-36	BT25036	36	28,10	132	140
T2,5-38	BT25038	38	29,70	132	140
T2,5-40	BT25040	40	31,30	132	140
T2,5-42	BT25042	42	32,90	140	140
T2,5-44	BT25044	44	34,50	140	140
T2,5-45	BT25045	45	35,30	140	140
T2,5-48	BT25048	48	37,70	140	140
T2,5-50	BT25050	50	39,29	160	160
T2,5-60	BT25060	60	47,25	160	160
T2,5-65	BT25065	65	51,20	160	160
T2,5-70	BT25070	70	55,20	160	160
T2,5-72	BT25072	72	56,80	160	160
T2,5-90	BT25090	90	71,12	160	160
T2,5-100	BT25100	100	79,08	160	160

Codice Code symbol Fabriknummer Code symbole Numero de fabrica	Nostro codice Our code Unser kode Notre code Nuestro codigo	N. denti N. of teeth Zahnezahl N. bre de dents Cantidad de dientes	De	Lu	L
T5-10	BT05010	10	15,05	125	140
T5-11	BT05011	11	16,65	125	140
T5-12	BT05012	12	18,25	125	140
T5-13	BT05013	13	19,85	125	140
T5-14	BT05014	14	21,45	132	140
T5-15	BT05015	15	23,05	132	140
T5-16	BT05016	16	24,60	140	140
T5-17	BT05017	17	26,20	140	140
T5-18	BT05018	18	27,80	140	140
T5-19	BT05019	19	29,40	140	140
T5-20	BT05020	20	31,00	160	160
T5-21	BT05021	21	32,70	160	160
T5-22	BT05022	22	34,15	160	160
T5-23	BT05023	23	35,85	160	160
T5-24	BT05024	24	37,40	160	160
T5-25	BT05025	25	38,95	160	160
T5-26	BT05026	26	40,60	160	160
T5-27	BT05027	27	42,20	160	160
T5-28	BT05028	28	43,75	160	160
T5-29	BT05029	29	45,35	160	160
T5-30	BT05030	30	46,95	160	160
T5-32	BT05032	32	50,10	160	160
T5-34	BT05034	34	53,25	160	160
T5-35	BT05035	35	54,85	160	160
T5-36	BT05036	36	56,45	160	160
T5-37	BT05037	37	58,06	160	160
T5-38	BT05038	38	59,65	160	160
T5-40	BT05040	40	62,85	160	160
T5-42	BT05042	42	66,00	160	160
T5-44	BT05044	44	69,20	160	160
T5-45	BT05045	45	70,80	160	160
T5-46	BT05046	46	72,40	160	160
T5-48	BT05048	48	75,55	160	160
T5-50	BT05050	50	78,75	160	160
T5-60	BT05060	60	94,65	160	160
T5-72	BT05072	72	113,75	160	160
T5-80	BT05080	80	126,48	160	160
T5-90	BT05090	90	142,40	160	160
T5-100	BT05100	100	158,31	160	160

Codice Code symbol Fabriknummer Code symbole Numero de fabrica	Nostro codice Our code Unser kode Notre code Nuestro codigo	N. denti N. of teeth Zahnezahl N. bre de dents Cantidad de dientes	De	Lu	L
T10-10	BT10010	10	29,98	140	140
T10-11	BT10011	11	33,16	140	140
T10-12	BT10012	12	36,35	140	140
T10-13	BT10013	13	39,50	140	140
T10-14	BT10014	14	42,70	160	160
T10-15	BT10015	15	45,90	160	160
T10-16	BT10016	16	49,10	160	160
T10-17	BT10017	17	52,25	160	160
T10-18	BT10018	18	55,45	160	160
T10-19	BT10019	19	58,65	160	160
T10-20	BT10020	20	61,80	160	160
T10-21	BT10021	21	65,00	160	160
T10-22	BT10022	22	68,20	160	160
T10-23	BT10023	23	71,35	160	160
T10-24	BT10024	24	74,55	160	160
T10-26	BT10026	26	80,90	160	160
T10-28	BT10028	28	87,25	160	160
T10-30	BT10030	30	93,65	160	160
T10-32	BT10032	32	100,00	160	160
T10-34	BT10034	34	106,40	160	160
T10-36	BT10036	36	112,75	160	160
T10-38	BT10038	38	119,10	160	160
T10-40	BT10040	40	125,45	160	160
T10-45	BT10045	45	141,40	160	160
T10-48	BT10048	48	150,95	160	160
T10-60	BT10060	60	189,10	160	160
T10-72	BT10072	72	227,29	160	160

Per barre con n. di denti non inclusi in queste tavole, chiedere per quotazione.

For bars with a number of teeth not included in these tables please ask for our quotation.

Verlangen sie Angebot für Stangen mit anzahl von Zahnen die nicht in diesen Tafeln aufgefuehrt sind.

Pour les barreaux avec un nombre de dents different du tableau, nous consulter.

Pidan oferta por lo que concierne a una cantidad de dientes no incluida en estas tablas.

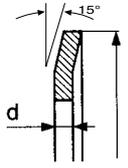
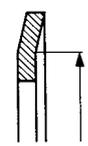
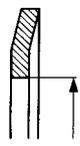

N. denti N. of teeth Zahnezahl N. bre de dents Cantidad de dientes	Flangia / Flanges / Bordscheiben / Flasques / Tapetas				Tipo flangia Flanges type Bordcheiben Typ Type flasques Tipo tapetas			
	d = 0,5 mm	d = 1 mm	d = 1 mm	d = 1,5 mm				
	T 2,5	T 5	T 10	T 20				
8	-	-	-	-	F 01	13,0	10,0	6,0
9	-	-	-	-	F 02	15,0	12,0	8,0
10	-	F 06	-	-	F 03	16,0	13,0	9,5
11	-	-	-	-	F 04	17,5	14,5	11,6
12	F 01	F 07	F 15	-	F 05	18,0	15,0	11,5
13	-	-	-	-	F 06	20,0	16,5	12,2
14	F 02	F 08	F 18	-	F 07	23,0	18,0	12,5
15	F 02	F 09	F 19	-	F 08	25,0	21,5	15,0
16	F 03	F 10	F 20	-	F 09	28,0	24,0	17,8
17	-	-	-	-	F 10	32,0	27,5	23,0
18	F 04	F 10	F 22	F 38	F 11	35,0	30,5	23,0
19	F 05	F 12	F 25	-	F 12	36,0	31,0	25,0
20	F 06	F 12	F 25	F 43	F 13	37,0	33,0	25,0
21	-	-	-	-	F 14	38,0	34,0	26,5
22	F 07	F 14	F 27	F 46	F 15	42,0	38,0	30,5
23	-	-	-	-	F 16	43,0	39,0	31,0
24	F 07	F 15	F 29	F 50	F 17	44,0	40,5	32,5
25	F 07	F 17	F 29	F 52	F 18	48,0	43,5	37,0
26	F 08	F 17	F 30	-	F 19	51,0	47,0	40,0
27	-	F 18	F 31	-	F 20	54,0	50,5	43,0
28	F 08	F 18	F 32	-	F 21	57,0	52,0	46,0
29	-	-	-	-	F 22	60,0	57,0	47,0
30	F 09	F 19	F 33	F 59	F 23	61,0	56,5	49,0
31	-	-	-	-	F 24	64,0	57,0	47,0
32	F 10	F 20	F 35	-	F 25	66,0	63,0	52,0
33	-	-	-	-	F 26	70,0	66,5	53,0
34	-	-	-	-	F 27	75,0	68,5	60,0
35	-	-	-	-	F 28	79,0	72,5	60,0
36	F 12	F 24	F 38	-	F 29	83,0	78,0	68,0
37	-	-	-	-	F 30	87,0	82,5	72,0
38	-	-	-	-	F 31	91,0	85,5	76,0
39	-	-	-	-	F 32	93,0	89,0	80,0
40	F 14	F 25	F 41	-	F 33	97,0	93,8	83,0
41	-	-	-	-	F 34	102,0	97,0	82,5
42	-	F 26	-	-	F 35	106,0	101,0	90,0
43	-	-	-	-	F 36	112,0	105,5	91,0
44	F 15	-	-	-	F 37	115,0	109,0	94,0
45	-	-	-	-	F 38	120,0	112,5	99,5
46	-	-	-	-	F 39	123,0	117,5	107,0
47	-	-	-	-	F 40	128,0	124,0	107,0
48	-	-	-	-	F 41	131,0	125,5	115,0
49	-	-	-	-	F 42	135,0	128,5	115,0
50	-	-	-	-	F 43	138,0	132,0	121,0
51	-	-	-	-	F 44	140,0	125,0	107,0
52	-	-	-	-	F 45	142,0	137,0	120,0
53	-	-	-	-	F 46	146,0	133,0	107,0
54	-	-	-	-	F 47	148,0	143,0	132,0
55	-	-	-	-	F 48	150,0	145,0	130,0
56	-	-	-	-	F 49	154,0	142,0	122,0
57	-	-	-	-	F 50	158,0	153,0	138,5
58	-	-	-	-	F 51	160,0	148,0	120,0
59	-	-	-	-	F 52	168,0	161,0	148,0
60	-	-	-	-	F 53	175,0	170,0	157,0
61	-	-	-	-	F 54	180,0	174,0	154,0
62	-	-	-	-	F 55	184,0	168,0	135,0
63	-	-	-	-	F 56	188,0	176,0	150,0
64	-	-	-	-	F 57	192,0	187,0	173,0
65	-	-	-	-	F 58	198,0	180,0	150,0
66	-	-	-	-	F 59	200,0	193,0	180,0
					F 60	205,0	189,0	160,0
					F 61	212,0	200,0	162,0
					F 62	226,0	214,0	190,0
					F 63	230,0	222,0	200,0
					F 64	240,0	224,0	192,0
					F 65	250,0	228,0	200,0
					F 66	256,0	240,0	220,0
					F 67	265,0	240,0	213,0
					F 68	275,0	253,0	225,0
					F 69	286,0	277,0	242,0
					F 70	296,0	287,0	260,0
					F 71	300,0	280,0	252,0
					F 72	325,0	305,0	278,0
					F 73	350,0	330,0	302,0
					F 74	375,0	355,0	328,0
					F 75	405,0	380,0	354,0
					F 76	430,0	406,0	380,0
					F 77	455,0	432,0	405,0
					F 78	480,0	457,0	430,0
					F 79	530,0	508,0	481,0
					F 80	595,0	572,0	544,0

**Pulegge per cinghie dentate  
passo metrico ST per cinghie «AT»**

**ST Timing belt pulleys metric pitch for «AT» belts**

**ST Zahnriemenscheiben metrische  
Teilung für «AT» riemen**

**Poulies dentées ST  
pour courroies «AT» pas métrique**

**Poleas dentadas ST para correas «AT»  
con paso metrico**

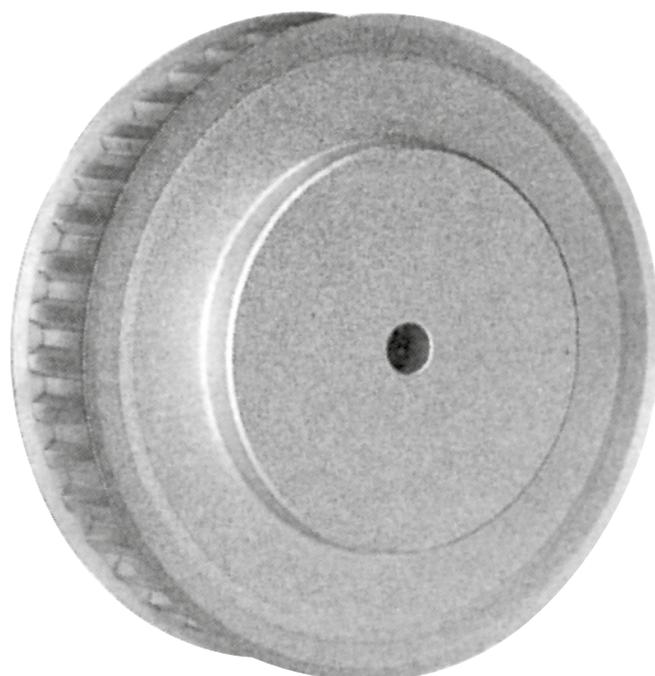

**Pulegge per cinghie dentate passo metrico ST per cinghie "AT"**  
**ST Timing belt pulleys metric pitch for "AT" belts**  
**ST Zahnriemenscheiben metrische Teilung für "AT" riemen**  
**Poulies dentées ST pour courroies "AT" pas métrique**  
**Poleas dentadas ST para correas "AT" con paso metrico**

<b>Materiale:</b> alluminio 6082 T6 UNI 9006/4 adatto al trattamento anodico	<b>Material:</b> aluminium 6082 T6 UNI 9006/4 suitable for anodic treatment	<b>Werkstoff:</b> aluminium 6082 T6 UNI 9006/4 geeignet für anodischen oxydation	<b>Matière:</b> aluminium 6082 T6 UNI 9006/4 apte au traitement anodique	<b>Material:</b> aluminio 6082 T6 UNI 9006/4 apto para la oxidacion anodica
---	--	---	---	--

**Tipo / Type**  
**6F**

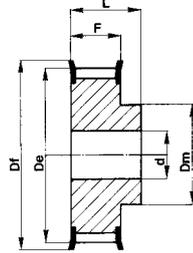

**Tipo / Type**  
**6**

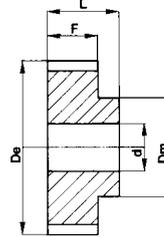

**ST 5**

(Passo 5 mm) per cinghia larghezza 10 mm	(Pitch 5 mm) for belt width 10 mm	(Teilung 5 mm) für Riemenbreite 10 mm	(Pas 5 mm) pour courroies largeur 10 mm	(Paso 5 mm) para correas ancho 10 mm
---	--------------------------------------	--	--	---

Code Code symbol / Fabriknummer Code symbole / Numero de fabrica	Nostro codice Our code / Unser kodex Notre code / Nuestro codigo	Tipo / Typ Type / Tipo	Tipo flangia Flanges type / Bordscheiben Typ Type flasques / Tipo tapetas	N. denti N. of teeth / Zahnezahl N. bre de dents / Cantidad de dientes	De	Df	Dm	F	L	d	Peso / Weight Gewicht / Poids / Peso Kg
21 ST5/12-2	21ST512	6F	F07	12	17,85	23,0	11	15	21	4	0,018
21 ST5/14-2	21ST514	6F	F08	14	21,05	25,0	14	15	21	4	0,019
21 ST5/15-2	21ST515	6F	F09	15	22,65	28,0	16	15	21	6	0,021
21 ST5/16-2	21ST516	6F	F10	16	24,20	32,0	18	15	21	6	0,025
21 ST5/18-2	21ST518	6F	F10	18	27,40	32,0	20	15	21	6	0,031
21 ST5/19-2	21ST519	6F	F12	19	29,00	36,0	22	15	21	6	0,036
21 ST5/20-2	21ST520	6F	F12	20	30,60	36,0	23	15	21	6	0,038
21 ST5/22-2	21ST522	6F	F14	22	33,85	38,0	24	15	21	6	0,048
21 ST5/24-2	21ST524	6F	F15	24	37,00	42,0	26	15	21	6	0,054
21 ST5/25-2	21ST525	6F	F17	25	38,60	44,0	26	15	21	6	0,058
21 ST5/26-2	21ST526	6F	F17	26	40,20	44,0	26	15	21	6	0,062
21 ST5/27-2	21ST527	6F	F18	27	41,80	48,0	30	15	21	8	0,064
21 ST5/28-2	21ST528	6F	F18	28	43,35	48,0	32	15	21	8	0,071
21 ST5/30-2	21ST530	6F	F19	30	46,55	51,0	34	15	21	8	0,076
21 ST5/32-2	21ST532	6F	F20	32	49,70	54,0	36	15	21	8	0,088
21 ST5/36-2	21ST536	6F	F24	36	56,05	64,0	38	15	21	8	0,114
21 ST5/40-2	21ST540	6F	F25	40	62,45	66,0	40	15	21	8	0,138
21 ST5/42-2	21ST542	6F	F26	42	65,60	70,0	40	15	21	8	0,180
21 ST5/44-0	21ST544	6	-	44	68,80	-	45	15	21	8	0,185
21 ST5/48-0	21ST548	6	-	48	75,15	-	50	15	21	8	0,200
21 ST5/60-0	21ST560	6	-	60	94,25	-	65	15	21	8	0,307

(Passo 5 mm) per cinghia larghezza 16 mm	(Pitch 5 mm) for belt width 16 mm	(Teilung 5 mm) für Riemenbreite 16 mm	(Pas 5 mm) pour courroies largeur 16 mm	(Paso 5 mm) para correas ancho 16 mm
---	--------------------------------------	--	--	---

27 ST5/12-2	27ST512	6F	F07	12	17,85	23,0	11	21	27	4	0,022
27 ST5/14-2	27ST514	6F	F08	14	21,05	25,0	14	21	27	4	0,026
27 ST5/15-2	27ST515	6F	F09	15	22,65	28,0	16	21	27	6	0,029
27 ST5/16-2	27ST516	6F	F10	16	24,20	32,0	18	21	27	6	0,035
27 ST5/18-2	27ST518	6F	F10	18	27,40	32,0	20	21	27	6	0,043
27 ST5/19-2	27ST519	6F	F12	19	29,00	36,0	22	21	27	6	0,049
27 ST5/20-2	27ST520	6F	F12	20	30,60	36,0	23	21	27	6	0,053
27 ST5/22-2	27ST522	6F	F14	22	33,85	38,0	24	21	27	6	0,054
27 ST5/24-2	27ST524	6F	F15	24	37,00	42,0	26	21	27	6	0,076
27 ST5/25-2	27ST525	6F	F17	25	38,60	44,0	26	21	27	6	0,081
27 ST5/26-2	27ST526	6F	F17	26	40,20	44,0	26	21	27	6	0,085
27 ST5/27-2	27ST527	6F	F18	27	41,80	48,0	30	21	27	8	0,090
27 ST5/28-2	27ST528	6F	F18	28	43,35	48,0	32	21	27	8	0,092
27 ST5/30-2	27ST530	6F	F19	30	46,55	51,0	34	21	27	8	0,105
27 ST5/32-2	27ST532	6F	F20	32	49,70	54,0	36	21	27	8	0,123
27 ST5/36-2	27ST536	6F	F24	36	56,05	64,0	38	21	27	8	0,160
27 ST5/40-2	27ST540	6F	F25	40	62,45	66,0	40	21	27	8	0,193
27 ST5/42-2	27ST542	6F	F26	42	65,60	70,0	40	21	27	8	0,205
27 ST5/44-0	27ST544	6	-	44	68,80	-	45	21	27	8	0,228
27 ST5/48-0	27ST548	6	-	48	75,15	-	50	21	27	8	0,280
27 ST5/60-0	27ST560	6	-	60	94,25	-	65	21	27	8	0,430

(Passo 5 mm) per cinghia larghezza 25 mm	(Pitch 5 mm) for belt width 25 mm	(Teilung 5 mm) für Riemenbreite 25 mm	(Pas 5 mm) pour courroies largeur 25 mm	(Paso 5 mm) para correas ancho 25 mm
---	--------------------------------------	--	--	---

36 ST5/12-2	36ST512	6F	F07	12	17,85	23,0	11	30	36	4	0,031
36 ST5/14-2	36ST514	6F	F08	14	21,05	25,0	14	30	36	4	0,037
36 ST5/15-2	36ST515	6F	F09	15	22,65	28,0	16	30	36	6	0,041
36 ST5/16-2	36ST516	6F	F10	16	24,20	32,0	18	30	36	6	0,050
36 ST5/18-2	36ST518	6F	F10	18	27,40	32,0	20	30	36	6	0,061
36 ST5/19-2	36ST519	6F	F12	19	29,00	36,0	22	30	36	6	0,070
36 ST5/20-2	36ST520	6F	F12	20	30,60	36,0	23	30	36	6	0,076
36 ST5/22-2	36ST522	6F	F14	22	33,85	38,0	24	30	36	6	0,080
36 ST5/24-2	36ST524	6F	F15	24	37,00	42,0	26	30	36	6	0,109
36 ST5/25-2	36ST525	6F	F17	25	38,60	44,0	26	30	36	6	0,118
36 ST5/26-2	36ST526	6F	F17	26	40,20	44,0	26	30	36	6	0,120
36 ST5/27-2	36ST527	6F	F18	27	41,80	48,0	30	30	36	8	0,128
36 ST5/28-2	36ST528	6F	F18	28	43,35	48,0	32	30	36	8	0,135
36 ST5/30-2	36ST530	6F	F19	30	46,55	51,0	34	30	36	8	0,150
36 ST5/32-2	36ST532	6F	F20	32	49,70	54,0	36	30	36	8	0,178
36 ST5/36-2	36ST536	6F	F24	36	56,05	64,0	38	30	36	8	0,230
36 ST5/40-2	36ST540	6F	F25	40	62,45	66,0	40	30	36	8	0,278
36 ST5/42-2	36ST542	6F	F26	42	65,60	70,0	40	30	36	8	0,284
36 ST5/44-0	36ST544	6	-	44	68,80	-	45	30	36	8	0,315
36 ST5/48-0	36ST548	6	-	48	75,15	-	50	30	36	8	0,400
36 ST5/60-0	36ST560	6	-	60	94,25	-	65	30	36	8	0,614



**Pulegge per cinghie dentate passo metrico ST per cinghie "AT"**  
**ST Timing belt pulleys metric pitch for "AT" belts**  
**ST Zahnriemenscheiben metrische Teilung für "AT" riemen**  
**Poulies dentées ST pour courroies "AT" pas métrique**  
**Poleas dentadas ST para correas "AT" con paso metrico**



**Materiale:** alluminio 6082 T6 UNI 9006/4 adatto al trattamento anodico  
**Material:** aluminium 6082 T6 UNI 9006/4 suitable for anodic treatment  
**Werkstoff:** aluminium 6082 T6 UNI 9006/4 geeignet für anodischen oxydation  
**Matière:** aluminium 6082 T6 UNI 9006/4 apte au traitement anodique  
**Material:** aluminio 6082 T6 UNI 9006/4 apto para la oxidación anodica

**Tipo / Type**  
**6F**

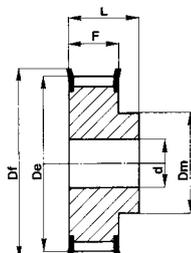

**Tipo / Type**  
**6**

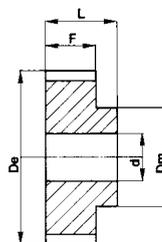

**ST 10**

(Passo 10 mm) per cinghia larghezza 16 mm (Pitch 10 mm) for belt width 16 mm (Teilung 10 mm) für Riemenbreite 16 mm (Pas 10 mm) pour courroies largeur 16 mm (Paso 10 mm) para correas ancho 16 mm

Codice Code symbol / Fabriknummer Code symbole / Numero de fabrica	Nostro codice Our code / Unser kode Notre code / Nuestro codigo	Tipo Type / Typ Type / Tipo	Tipo flangia Flanges type / Bordscheiben Typ Type flasques / Tipo tapetas	N. denti N. of teeth / Zahnezahl N. bre de dents / Cantidad de dientes	De	Df	Dm	F	L	d	Peso / Weight Gewicht / Poids / Peso Kg
31 ST10/15-2	31ST115	6F	F19	15	45,90	51	31	21	31	8	0,118
31 ST10/16-2	31ST116	6F	F20	16	49,05	54	35	21	31	8	0,134
31 ST10/18-2	31ST118	6F	F22	18	55,45	60	40	21	31	8	0,167
31 ST10/19-2	31ST119	6F	F25	19	58,60	66	44	21	31	8	0,184
31 ST10/20-2	31ST120	6F	F25	20	61,80	66	46	21	31	8	0,208
31 ST10/22-2	31ST122	6F	F27	22	68,15	75	52	21	31	8	0,253
31 ST10/24-2	31ST124	6F	F29	24	74,55	83	58	21	31	8	0,288
31 ST10/25-2	31ST125	6F	F29	25	77,70	83	60	21	31	8	0,310
31 ST10/26-2	31ST126	6F	F30	26	80,90	87	60	21	31	8	0,357
31 ST10/27-2	31ST127	6F	F31	27	84,10	91	60	21	31	8	0,364
31 ST10/28-2	31ST128	6F	F32	28	87,25	93	60	21	31	8	0,401
31 ST10/30-2	31ST130	6F	F33	30	93,65	97	60	21	31	8	0,441
31 ST10/32-2	31ST132	6F	F35	32	100,00	106	65	21	31	10	0,493
31 ST10/36-2	31ST136	6F	F38	36	112,75	120	70	21	31	10	0,623
31 ST10/40-2	31ST140	6F	F42	40	125,45	135	80	21	31	10	0,787
31 ST10/44-0	31ST144	6		44	138,20	-	88	21	31	10	0,993
31 ST10/48-0	31ST148	6		48	150,95	-	95	21	31	16	1,090
31 ST10/60-0	31ST160	6		60	189,10	-	110	21	31	16	1,701

(Passo 10 mm) per cinghia larghezza 25 mm (Pitch 10 mm) for belt width 25 mm (Teilung 10 mm) für Riemenbreite 25 mm (Pas 10 mm) pour courroies largeur 25 mm (Paso 10 mm) para correas ancho 25 mm

40 ST10/15-2	40ST115	6F	F19	15	45,90	51	32	30	40	8	0,152
40 ST10/16-2	40ST116	6F	F20	16	49,05	54	35	30	40	8	0,176
40 ST10/18-2	40ST118	6F	F22	18	55,45	60	40	30	40	8	0,224
40 ST10/19-2	40ST119	6F	F25	19	58,60	66	44	30	40	8	0,247
40 ST10/20-2	40ST120	6F	F25	20	61,80	66	46	30	40	8	0,276
40 ST10/22-2	40ST122	6F	F27	22	68,15	75	52	30	40	8	0,337
40 ST10/24-2	40ST124	6F	F29	24	74,55	83	58	30	40	8	0,392
40 ST10/25-2	40ST125	6F	F29	25	77,70	83	60	30	40	8	0,422
40 ST10/26-2	40ST126	6F	F30	26	80,90	87	60	30	40	8	0,477
40 ST10/27-2	40ST127	6F	F31	27	84,10	91	60	30	40	8	0,536
40 ST10/28-2	40ST128	6F	F32	28	87,25	93	60	30	40	8	0,540
40 ST10/30-2	40ST130	6F	F33	30	93,65	97	60	30	40	8	0,640
40 ST10/32-2	40ST132	6F	F35	32	100,00	106	65	30	40	10	0,693
40 ST10/36-2	40ST136	6F	F38	36	112,75	120	70	30	40	10	0,873
40 ST10/40-2	40ST140	6F	F42	40	125,45	135	80	30	40	10	1,067
40 ST10/44-0	40ST144	6		44	138,20	-	88	30	40	10	1,350
40 ST10/48-0	40ST148	6		48	150,95	-	95	30	40	16	1,516
40 ST10/60-0	40ST160	6		60	189,10	-	110	30	40	16	2,339

**Pulegge per cinghie dentate passo metrico ST per cinghie "AT"**  
**ST Timing belt pulleys metric pitch for "AT" belts**  
**ST Zahnriemenscheiben metrische Teilung für "AT" riemen**  
**Poulies dentées ST pour courroies "AT" pas métrique**  
**Poleas dentadas ST para correas "AT" con paso metrico**

**Materiale:**  
 alluminio 6082 T6 UNI  
 9006/4 adatto al trattamento  
 anodico

**Material:**  
 aluminium 6082 T6 UNI  
 9006/4 suitable for anodic  
 treatment

**Werkstoff:**  
 aluminium 6082 T6 UNI  
 9006/4 geeignet für  
 anodischen oxydation

**Matière:**  
 aluminium 6082 T6 UNI  
 9006/4 apte au traitement  
 anodique

**Material:**  
 aluminio 6082 T6 UNI  
 9006/4 apto para la  
 oxidacion anodica

**Tipo / Type**  
**6F**

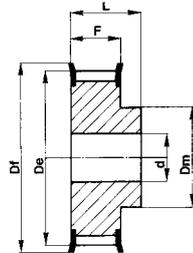

**Tipo / Type**  
**6**

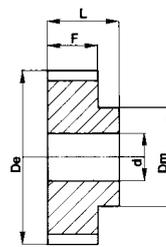

### ST 10

(Passo 10 mm)  
 per cinghia larghezza 32 mm

(Pitch 10 mm)  
 for belt width 32 mm

(Teilung 10 mm)  
 für Riemenbreite 32 mm

(Pas 10 mm)  
 pour courroies largeur 32 mm

(Paso 10 mm)  
 para correas ancho 32 mm

Codice Code symbol / Fabriknummer Code symbole / Numero de fabrica	Nostro codice Our code / Unser kode Notre code / Nuestro codigo	Tipo Type / Typ Type / Tipo	Tipo flangia Flanges type / Bordscheiben Typ Type flasques / Tipo tapetas	N. denti N. of teeth / Zahnezahl N. bre de dents / Cantidad de dientes	De	Df	Dm	F	L	d	Peso / Weight Gewicht / Poids / Peso Kg
47 ST10/18-2	47ST118	6F	F22	18	55,45	60	40	37	47	10	0,253
47 ST10/19-2	47ST119	6F	F25	19	58,60	66	44	37	47	10	0,286
47 ST10/20-2	47ST120	6F	F25	20	61,80	66	46	37	47	12	0,322
47 ST10/22-2	47ST122	6F	F27	22	68,15	75	52	37	47	12	0,393
47 ST10/24-2	47ST124	6F	F29	24	74,55	83	58	37	47	12	0,475
47 ST10/25-2	47ST125	6F	F29	25	77,70	83	60	37	47	12	0,527
47 ST10/26-2	47ST126	6F	F30	26	80,90	87	60	37	47	12	0,564
47 ST10/27-2	47ST127	6F	F31	27	84,10	91	60	37	47	12	0,602
47 ST10/28-2	47ST128	6F	F32	28	87,25	93	60	37	47	12	0,642
47 ST10/30-2	47ST130	6F	F33	30	93,65	97	60	37	47	12	0,740
47 ST10/32-2	47ST132	6F	F35	32	100,00	106	65	37	47	12	0,844
47 ST10/36-2	47ST136	6F	F38	36	112,75	120	70	37	47	16	1,063
47 ST10/40-2	47ST140	6F	F42	40	125,45	135	80	37	47	16	1,317
47 ST10/44-0	47ST144	6	-	44	138,20	-	88	37	47	16	1,611
47 ST10/48-0	47ST148	6	-	48	150,95	-	95	37	47	16	1,931
47 ST10/60-0	47ST160	6	-	60	189,10	-	110	37	47	16	3,004

(Passo 10 mm)  
 per cinghia larghezza 50 mm

(Pitch 10 mm)  
 for belt width 50 mm

(Teilung 10 mm)  
 für Riemenbreite 50 mm

(Pas 10 mm)  
 pour courroies largeur 50 mm

(Paso 10 mm)  
 para correas ancho 50 mm

66 ST10/18-2	66ST118	6F	F22	18	55,45	60	40	56	66	10	0,422
66 ST10/19-2	66ST119	6F	F25	19	58,60	66	44	56	66	10	0,466
66 ST10/20-2	66ST120	6F	F25	20	61,80	66	46	56	66	12	0,520
66 ST10/22-2	66ST122	6F	F27	22	68,15	75	52	56	66	12	0,570
66 ST10/24-2	66ST124	6F	F29	24	74,55	83	58	56	66	12	0,736
66 ST10/25-2	66ST125	6F	F29	25	77,70	83	60	56	66	12	0,766
66 ST10/26-2	66ST126	6F	F30	26	80,90	87	60	56	66	12	0,816
66 ST10/27-2	66ST127	6F	F31	27	84,10	91	60	56	66	12	0,946
66 ST10/28-2	66ST128	6F	F32	28	87,25	93	60	56	66	12	0,960
66 ST10/30-2	66ST130	6F	F33	30	93,65	97	60	56	66	12	1,169
66 ST10/32-2	66ST132	6F	F35	32	100,00	106	65	56	66	12	1,300
66 ST10/36-2	66ST136	6F	F38	36	112,75	120	70	56	66	16	1,637
66 ST10/40-2	66ST140	6F	F42	40	125,45	135	80	56	66	16	1,999
66 ST10/44-0	66ST144	6	-	44	138,20	-	88	56	66	16	2,357
66 ST10/48-0	66ST148	6	-	48	150,95	-	95	56	66	16	2,830
66 ST10/60-0	66ST160	6	-	60	189,10	-	110	56	66	16	4,368

**Barre dentate standard ST per cinghie " AT "**  
**ST Standard toothed bars for " AT " belts**  
**ST Standard Zahnriemenstangen für " AT "**  
**Barreaux dentés standard ST pour courroies " AT "**  
**Barras dentadas de serie ST para correas " AT "**

**Materiale:** alluminio 6082 T6 UNI 9006/4 adatto al trattamento anodico  
**Material:** aluminium 6082 T6 UNI 9006/4 suitable for anodic treatment  
**Werkstoff:** aluminium 6082 T6 UNI 9006/4 geeignet für anodischen oxydation  
**Matière:** aluminium 6082 T6 UNI 9006/4 apte au traitement anodique  
**Material:** aluminio 6082 T6 UNI 9006/4 apto para la oxidacion anodica

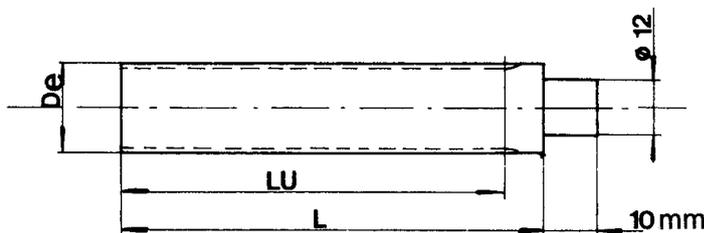

**ST 5**

(Passo 5 mm) / (Pitch 5 mm) / (Teilung 5 mm) / (Pas 5 mm) / (Paso 5 mm)

Codice Code symbol Fabriknummer Code symbole Numero de fabrica	Nostro codice Our code Unser kode Notre code Nuestro codigo	N. denti N. of teeth Zahnezahl N. bre de dents Cantidad de dientes	De	Lu	L
ST05012	BST0512	12	17,85	125	140
ST05013	BST0513	13	19,45	125	140
ST05014	BST0514	14	21,05	132	140
ST05015	BST0515	15	22,65	132	140
ST05016	BST0516	16	24,20	140	140
ST05017	BST0517	17	25,80	140	140
ST05018	BST0518	18	27,40	140	140
ST05019	BST0519	19	29,00	140	140
ST05020	BST0520	20	30,60	160	160
ST05021	BST0521	21	32,30	160	160
ST05022	BST0522	22	33,85	160	160
ST05023	BST0523	23	35,45	160	160
ST05024	BST0524	24	37,00	160	160
ST05025	BST0525	25	38,60	160	160
ST05026	BST0526	26	40,20	160	160
ST05027	BST0527	27	41,80	160	160
ST05028	BST0528	28	43,35	160	160
ST05029	BST0529	29	44,95	160	160
ST05030	BST0530	30	46,55	160	160
ST05031	BST0531	31	48,15	160	160
ST05032	BST0532	32	49,70	160	160
ST05033	BST0533	33	51,30	160	160
ST05034	BST0534	34	52,85	160	160
ST05035	BST0535	35	54,45	160	160
ST05036	BST0536	36	56,05	160	160
ST05038	BST0538	38	59,25	160	160
ST05040	BST0540	40	62,45	160	160
ST05042	BST0542	42	65,60	160	160
ST05044	BST0544	44	68,80	160	160
ST05045	BST0545	45	70,40	160	160
ST05046	BST0546	46	72,00	160	160
ST05048	BST0548	48	75,15	160	160
ST05050	BST0550	50	78,35	160	160
ST05052	BST0552	52	81,55	160	160
ST05054	BST0554	54	84,70	160	160
ST05055	BST0555	55	86,30	160	160
ST05056	BST0556	56	87,90	160	160
ST05058	BST0558	58	91,10	160	160
ST05060	BST0560	60	94,25	160	160
ST05062	BST0562	62	97,45	160	160
ST05064	BST0564	64	100,65	160	160
ST05065	BST0565	65	102,25	160	160
ST05070	BST0570	70	110,20	160	160
ST05072	BST0572	72	113,25	160	160

**ST 10**

(Passo 10 mm) / (Pitch 10 mm) / (Teilung 10 mm) / (Pas 10 mm) / (Paso 10 mm)

Codice Code symbol Fabriknummer Code symbole Numero de fabrica	Nostro codice Our code Unser kode Notre code Nuestro codigo	N. denti N. of teeth Zahnezahl N. bre de dents Cantidad de dientes	De	Lu	L
ST10015	BST1015	15	45,90	160	160
ST10016	BST1016	16	49,05	160	160
ST10017	BST1017	17	52,25	160	160
ST10018	BST1018	18	55,45	160	160
ST10019	BST1019	19	58,60	160	160
ST10020	BST1020	20	61,80	160	160
ST10021	BST1021	21	65,00	160	160
ST10022	BST1022	22	68,15	160	160
ST10023	BST1023	23	71,35	160	160
ST10024	BST1024	24	74,55	160	160
ST10025	BST1025	25	77,70	160	160
ST10026	BST1026	26	80,90	160	160
ST10027	BST1027	27	84,10	160	160
ST10028	BST1028	28	87,25	160	160
ST10029	BST1029	29	90,45	160	160
ST10030	BST1030	30	93,65	160	160
ST10031	BST1031	31	96,80	160	160
ST10032	BST1032	32	100,00	160	160
ST10033	BST1033	33	103,20	160	160
ST10034	BST1034	34	106,40	160	160
ST10035	BST1035	35	109,55	160	160
ST10036	BST1036	36	112,75	160	160
ST10037	BST1037	37	115,90	160	160
ST10038	BST1038	38	119,10	160	160
ST10040	BST1040	40	125,45	160	160
ST10041	BST1041	41	128,65	160	160
ST10042	BST1042	42	131,85	160	160
ST10044	BST1044	44	138,20	160	160
ST10045	BST1045	45	141,40	160	160
ST48046	BST1046	46	144,55	160	160
ST10048	BST1048	48	150,95	160	160
ST10050	BST1050	50	157,30	160	160
ST10051	BST1051	51	160,50	160	160
ST10052	BST1052	52	163,65	160	160
ST10054	BST1054	54	170,05	160	160
ST10055	BST1055	55	173,20	160	160
ST10056	BST1056	56	176,40	160	160
ST10057	BST1057	57	179,60	160	160
ST10058	BST1058	58	182,75	160	160
ST10059	BST1059	59	185,95	160	160
ST10060	BST1060	60	189,10	160	160
ST10062	BST1062	62	195,50	160	160
ST10070	BST1070	70	220,95	160	160
ST10075	BST1075	75	236,90	160	160

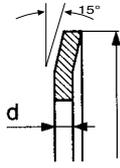
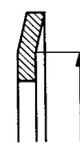
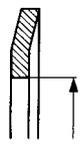

N. denti N. of teeth Zahnezahl N. bre de dents Cantidad de dientes	Flangia / Flanges / Bordscheiben / Flasques / Tapetas		Tipo flangia Flanges type Bordcheiben Typ Type flasques Tipo tapetas			
	d = 1 mm	d = 1 mm				
	<b>AT 5</b>	<b>AT 10</b>				
8	-	-				
9	-	-				
10	-	-				
11	-	-				
12	F 07	-	<b>F 01</b>	13,0	10,0	6,0
13	-	-	<b>F 02</b>	15,0	12,0	8,0
14	F 08	-	<b>F 03</b>	16,0	13,0	9,5
15	F 09	F 19	<b>F 04</b>	17,5	14,5	11,6
16	F 10	F 20	<b>F 05</b>	18,0	15,0	11,5
17	-	-	<b>F 06</b>	20,0	16,5	12,2
18	F 10	F 22	<b>F 07</b>	23,0	18,0	12,5
19	F 12	F 25	<b>F 08</b>	25,0	21,5	15,0
20	F 12	F 25	<b>F 09</b>	28,0	24,0	17,8
21	-	-	<b>F 10</b>	32,0	27,5	23,0
22	F 14	F 27	<b>F 11</b>	35,0	30,5	23,0
23	-	-	<b>F 12</b>	36,0	31,0	25,0
24	F 15	F 29	<b>F 13</b>	37,0	33,0	25,0
25	F 17	F 29	<b>F 14</b>	38,0	34,0	26,5
26	F 17	F 30	<b>F 15</b>	42,0	38,0	30,5
27	F 18	F 31	<b>F 16</b>	43,0	39,0	31,0
28	F 18	F 32	<b>F 17</b>	44,0	40,5	32,5
29	-	-	<b>F 18</b>	48,0	43,5	37,0
30	F 19	F 33	<b>F 19</b>	51,0	47,0	40,0
31	-	-	<b>F 20</b>	54,0	50,5	43,0
32	F 20	F 35	<b>F 21</b>	57,0	52,0	46,0
33	-	-	<b>F 22</b>	60,0	57,0	47,0
34	-	-	<b>F 23</b>	61,0	56,5	49,0
35	-	-	<b>F 24</b>	64,0	57,0	47,0
36	F 24	F 38	<b>F 25</b>	66,0	63,0	52,0
37	-	-	<b>F 26</b>	70,0	66,5	53,0
38	-	-	<b>F 27</b>	75,0	68,5	60,0
39	-	-	<b>F 28</b>	79,0	72,5	60,0
40	F 25	F 42	<b>F 29</b>	83,0	78,0	68,0
41	-	-	<b>F 30</b>	87,0	82,5	72,0
42	F 26	-	<b>F 31</b>	91,0	85,5	76,0
43	-	-	<b>F 32</b>	93,0	89,0	80,0
44	-	-	<b>F 33</b>	97,0	93,8	83,0
45	-	-	<b>F 34</b>	102,0	97,0	82,5
46	-	-	<b>F 35</b>	106,0	101,0	90,0
47	-	-	<b>F 36</b>	112,0	105,5	91,0
48	-	-	<b>F 37</b>	115,0	109,0	94,0
49	-	-	<b>F 38</b>	120,0	112,5	99,5
50	-	-	<b>F 39</b>	123,0	117,5	107,0
51	-	-	<b>F 40</b>	128,0	124,0	107,0
52	-	-	<b>F 41</b>	131,0	125,5	115,0
53	-	-	<b>F 42</b>	135,0	128,5	115,0
54	-	-	<b>F 43</b>	138,0	132,0	121,0
55	-	-	<b>F 44</b>	140,0	125,0	107,0
56	-	-	<b>F 45</b>	142,0	137,0	120,0
57	-	-	<b>F 46</b>	146,0	133,0	107,0
58	-	-	<b>F 47</b>	148,0	143,0	132,0
59	-	-	<b>F 48</b>	150,0	145,0	130,0
60	-	-	<b>F 49</b>	154,0	142,0	122,0
61	-	-	<b>F 50</b>	158,0	153,0	138,5
62	-	-	<b>F 51</b>	160,0	148,0	120,0
63	-	-	<b>F 52</b>	168,0	161,0	148,0
64	-	-	<b>F 53</b>	175,0	170,0	157,0
65	-	-	<b>F 54</b>	180,0	174,0	154,0
66	-	-	<b>F 55</b>	184,0	177,0	162,0
			<b>F 56</b>	188,0	176,0	150,0
			<b>F 57</b>	192,0	187,0	173,0
			<b>F 58</b>	198,0	180,0	150,0
			<b>F 59</b>	200,0	193,0	180,0
			<b>F 60</b>	205,0	189,0	160,0
			<b>F 61</b>	212,0	200,0	162,0
			<b>F 62</b>	226,0	214,0	190,0
			<b>F 63</b>	230,0	222,0	200,0
			<b>F 64</b>	240,0	224,0	192,0
			<b>F 65</b>	250,0	228,0	200,0
			<b>F 66</b>	256,0	240,0	220,0
			<b>F 67</b>	265,0	240,0	213,0
			<b>F 68</b>	275,0	253,0	225,0
			<b>F 69</b>	286,0	277,0	242,0
			<b>F 70</b>	296,0	287,0	260,0
			<b>F 71</b>	300,0	280,0	252,0
			<b>F 72</b>	325,0	305,0	278,0
			<b>F 73</b>	350,0	330,0	302,0
			<b>F 74</b>	375,0	355,0	328,0
			<b>F 75</b>	405,0	380,0	354,0
			<b>F 76</b>	430,0	406,0	380,0
			<b>F 77</b>	455,0	432,0	405,0
			<b>F 78</b>	480,0	457,0	430,0
			<b>F 79</b>	530,0	508,0	481,0
			<b>F 80</b>	595,0	572,0	544,0
			<b>F 81</b>	184,0	168,0	135,0

**Pulegge dentate per cinghie HTD®**  
**Timing belt pulleys HTD®**  
**HTD® Zahnriemenscheiben**  
**Poulies dentées HTD®**  
**Poleas para correas dentadas HTD®**

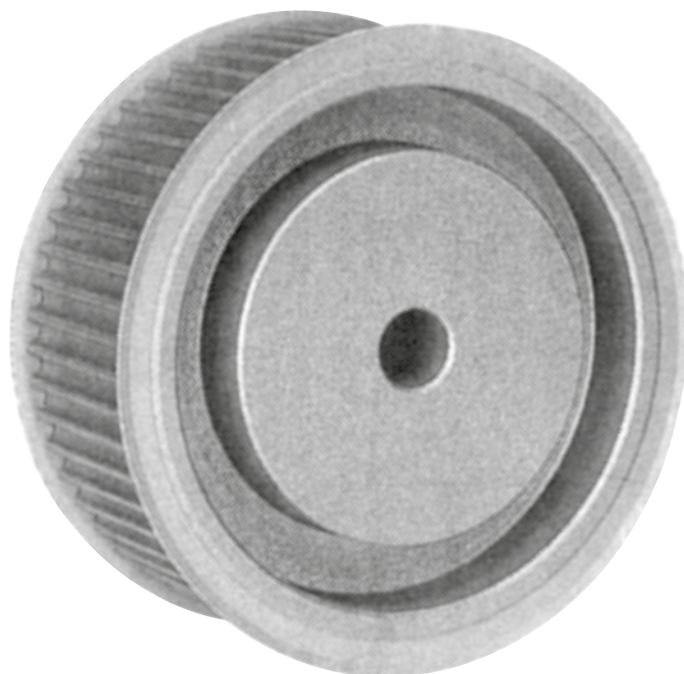

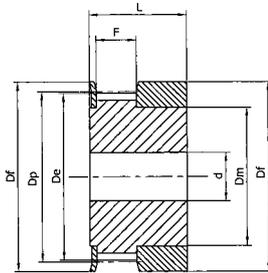

**Tipo / Type**  
**1F**

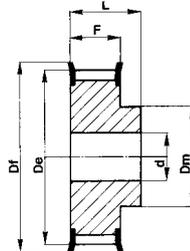

**Tipo / Type**  
**6F**

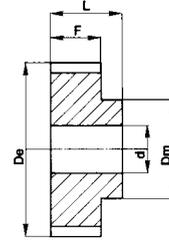

**Tipo / Type**  
**6**

### HTD® 3M-06

Caratteristiche Features Merkmale Características	Codice Code symbol Fabriknummer Code symbole Numero de fabrica	Nostro codice Our code Unser kode Notre code Nuestro codigo	Tipo Type Typ Type Tipo	Tipo flangia Flanges type Bordscheiben Typ Type flasques Tipo tapetas	N. denti N. of teeth Zahnezahl N. bre de dents Cantidad de dientes	Dp	De	Df	Dm	F	L	Foro stock Stock bore Vor bohrung Alesage en stock Agujero de stock	Peso Weight / Gewicht Poids / Peso Kg
Alluminio / Aluminium / Aluminium / Aluminium / Aluminium 6082 T6 UNI 9006/4  con flangia / with flanges mit Flanges / avec flasques con tapetas	<b>10 3M 06</b>	<b>03M0610</b>	1F	F01	10	9,55	8,79	13,0	6,0	7,2	14,5	4	
	<b>12 3M 06</b>	<b>03M0612</b>	1F	F02	12	11,46	10,70	15,0	8,0	7,2	14,5	4	
	<b>14 3M 06</b>	<b>03M0614</b>	1F	F03	14	13,37	12,61	16,0	9,5	7,2	14,5	4	
	<b>153M 06</b>	<b>03M0615</b>	1F	F04	15	14,32	13,56	17,5	11,6	7,2	14,5	4	
	<b>16 3M 06</b>	<b>03M0616</b>	6F	F05	16	15,28	14,52	18,0	10,0	9,8	17,5	4	
	<b>18 3M 06</b>	<b>03M0618</b>	6F	F06	18	17,19	16,43	20,0	11,0	9,8	17,5	6	
	<b>20 3M 06</b>	<b>03M0620</b>	6F	F07	20	19,10	18,34	23,0	13,0	9,8	17,5	6	
	<b>21 3M 06</b>	<b>03M0621</b>	6F	F08	21	20,05	19,29	25,0	13,0	9,8	17,5	6	
	<b>22 3M 06</b>	<b>03M0622</b>	6F	F08	22	21,01	20,25	25,0	13,0	9,8	17,5	6	
	<b>24 3M 06</b>	<b>03M0624</b>	6F	F08	24	22,92	22,16	25,0	13,0	9,8	17,5	6	
	<b>26 3M 06</b>	<b>03M0626</b>	6F	F09	26	24,83	24,07	28,0	16,0	9,8	17,5	6	
	<b>28 3M 06</b>	<b>03M0628</b>	6F	F10	28	26,74	25,98	32,0	18,0	9,8	17,5	6	
	<b>30 3M 06</b>	<b>03M0630</b>	6F	F10	30	28,65	27,89	32,0	20,0	9,8	17,5	6	
	<b>32 3M 06</b>	<b>03M0632</b>	6F	F12	32	30,56	29,80	36,0	22,0	9,8	17,5	6	
	<b>36 3M 06</b>	<b>03M0636</b>	6F	F14	36	34,38	33,62	38,0	26,0	10,3	18,0	6	
<b>40 3M 06</b>	<b>03M0640</b>	6F	F15	40	38,20	37,44	42,0	28,0	10,3	18,0	6		
<b>44 3M 06</b>	<b>03M0644</b>	6F	F18	44	42,02	41,26	48,0	33,0	10,3	18,0	6		
senza flangia / without flanges ohne Flanschen / sans flasques sin tapetas	<b>48 3M 06</b>	<b>03M0648</b>	6		48	45,84	45,08	-	33,0	10,3	18,6	8	
	<b>60 3M 06</b>	<b>03M0660</b>	6		60	57,30	56,54	-	33,0	10,3	18,6	8	
	<b>72 3M 06</b>	<b>03M0672</b>	6		72	68,75	67,99	-	33,0	10,3	18,6	8	

**Pulegge dentate per cinghie HTD® / Timing belt pulleys HTD®**  
**HTD® Zahnriemenscheiben / Poulies dentées HTD®**  
**Poleas para correas dentadas HTD®**



**HTD® 3M-09**

Caratteristiche Features Merkmale Características	Codice Code symbol Fabriknummer Code symbole Numero de fabrica	Nostro codice Our code Unser kode Notre code Nuestro codigo	Tipo Type Typ Type Tipo	Tipo flangia Flanges type Bordscheiben Typ Type flasques Tipo tapetas	N. denti N. of teeth Zahnezahl N. bre de dents Cantidad de dientes	Dp	De	Df	Dm	F	L	Foro stock Stock bore Vor bohrung Alesage en stock Agujero de stock	Peso Weight / Gewicht Poids / Peso Kg	
Alluminio / Aluminium / Aluminium / Aluminium / Aluminio 6082 T6 UNI 9006/4 con flangia / with flanges mit Flanges / avec flasques con tapetas	<b>10 3M 09</b>	<b>03M0910</b>	1F	F01	10	9,55	8,79	13,0	6,0	10,2	17,5	4	0,004	
	<b>12 3M 09</b>	<b>03M0912</b>	1F	F02	12	11,46	10,70	15,0	8,0	10,2	17,5	4	0,006	
	<b>14 3M 09</b>	<b>03M0914</b>	1F	F03	14	13,37	12,61	16,0	9,5	10,2	17,5	4	0,007	
	<b>15 3M 09</b>	<b>03M0915</b>	1F	F04	15	14,32	13,56	17,5	11,6	10,2	17,5	4	0,008	
	<b>16 3M 09</b>	<b>03M0916</b>	6F	F05	16	15,28	14,52	18,0	10,0	12,8	20,6	4	0,007	
	<b>18 3M 09</b>	<b>03M0918</b>	6F	F06	18	17,19	16,43	20,0	11,0	12,8	20,6	6	0,008	
	<b>20 3M 09</b>	<b>03M0920</b>	6F	F07	20	19,10	18,34	23,0	13,0	12,8	20,6	6	0,010	
	<b>21 3M 09</b>	<b>03M0921</b>	6F	F08	21	20,05	19,29	25,0	13,0	12,8	20,6	6	0,013	
	<b>22 3M 09</b>	<b>03M0922</b>	6F	F08	22	21,01	20,25	25,0	13,0	12,8	20,6	6	0,014	
	<b>24 3M 09</b>	<b>03M0924</b>	6F	F08	24	22,92	22,16	25,0	13,0	12,8	20,6	6	0,016	
	<b>26 3M 09</b>	<b>03M0926</b>	6F	F09	26	24,83	24,07	28,0	16,0	12,8	20,6	6	0,018	
	<b>28 3M 09</b>	<b>03M0928</b>	6F	F10	28	26,74	25,98	32,0	18,0	12,8	20,6	6	0,024	
	<b>30 3M 09</b>	<b>03M0930</b>	6F	F10	30	28,65	27,89	32,0	20,0	12,8	20,6	6	0,028	
	<b>32 3M 09</b>	<b>03M0932</b>	6F	F12	32	30,56	29,80	36,0	22,0	12,8	20,6	6	0,032	
	<b>36 3M 09</b>	<b>03M0936</b>	6F	F14	36	34,38	33,62	38,0	26,0	13,4	22,2	6	0,045	
	<b>40 3M 09</b>	<b>03M0940</b>	6F	F15	40	38,20	37,44	42,0	28,0	13,4	22,2	6	0,055	
	<b>44 3M 09</b>	<b>03M0944</b>	6F	F18	44	42,02	41,26	48,0	33,0	13,4	22,2	6	0,074	
	senza flangia / without flanges / ohne Flanschen sans flasques / sin tapetas	<b>48 3M 09</b>	<b>03M0948</b>	6		48	45,84	45,08	-	33,0	13,4	22,2	8	0,074
		<b>60 3M 09</b>	<b>03M0960</b>	6		60	57,30	56,54	-	33,0	13,4	22,2	8	0,106
		<b>72 3M 09</b>	<b>03M0972</b>	6		72	68,75	67,99	-	33,0	13,4	22,2	8	0,145

**HTD® 3M-15**

Caratteristiche Features Merkmale Características	Codice Code symbol Fabriknummer Code symbole Numero de fabrica	Nostro codice Our code Unser kode Notre code Nuestro codigo	Tipo Type Typ Type Tipo	Tipo flangia Flanges type Bordscheiben Typ Type flasques Tipo tapetas	N. denti N. of teeth Zahnezahl N. bre de dents Cantidad de dientes	Dp	De	Df	Dm	F	L	Foro stock Stock bore Vor bohrung Alesage en stock Agujero de stock	Peso Weight / Gewicht Poids / Peso Kg	
Alluminio / Aluminium / Aluminium / Aluminium / Aluminio 6082 T6 UNI 9006/4 con flangia / with flanges mit Flanges / avec flasques con tapetas	<b>10 3M 15</b>	<b>03M1510</b>	1F	F01	10	9,55	8,79	13,0	6,0	17,0	26	4	0,006	
	<b>12 3M 15</b>	<b>03M1512</b>	1F	F02	12	11,46	10,70	15,0	8,0	17,0	26	4	0,008	
	<b>14 3M 15</b>	<b>03M1514</b>	1F	F03	14	13,37	12,61	16,0	9,5	17,0	26	4	0,010	
	<b>15 3M 15</b>	<b>03M1515</b>	1F	F04	15	14,32	13,56	17,5	11,6	17,0	26	4	0,012	
	<b>16 3M 15</b>	<b>03M1516</b>	6F	F05	16	15,28	14,52	18,0	10,0	19,5	26	4	0,010	
	<b>18 3M 15</b>	<b>03M1518</b>	6F	F06	18	17,19	16,43	20,0	11,0	19,5	26	6	0,012	
	<b>20 3M 15</b>	<b>03M1520</b>	6F	F07	20	19,10	18,34	23,0	12,0	19,5	26	6	0,014	
	<b>21 3M 15</b>	<b>03M1521</b>	6F	F08	21	20,05	19,29	25,0	13,0	19,5	26	6	0,016	
	<b>22 3M 15</b>	<b>03M1522</b>	6F	F08	22	21,01	20,25	25,0	13,0	19,5	26	6	0,018	
	<b>24 3M 15</b>	<b>03M1524</b>	6F	F08	24	22,92	22,16	25,0	13,0	19,5	26	6	0,020	
	<b>26 3M 15</b>	<b>03M1526</b>	6F	F09	26	24,83	24,07	28,0	16,0	19,5	26	6	0,027	
	<b>28 3M 15</b>	<b>03M1528</b>	6F	F10	28	26,74	25,98	32,0	18,0	19,5	26	6	0,030	
	<b>30 3M 15</b>	<b>03M1530</b>	6F	F10	30	28,65	27,89	32,0	20,0	19,5	26	6	0,035	
	<b>32 3M 15</b>	<b>03M1532</b>	6F	F12	32	30,56	29,80	36,0	22,0	19,5	26	6	0,042	
	<b>36 3M 15</b>	<b>03M1536</b>	6F	F14	36	34,38	33,62	38,0	26,0	20,0	30	6	0,060	
	<b>40 3M 15</b>	<b>03M1540</b>	6F	F15	40	38,20	37,44	42,0	28,0	20,0	30	6	0,075	
	<b>44 3M 15</b>	<b>03M1544</b>	6F	F18	44	42,02	41,26	48,0	33,0	20,0	30	6	0,095	
	senza flangia / without flanges / ohne Flanschen sans flasques / sin tapetas	<b>48 3M 15</b>	<b>03M1548</b>	6		48	45,84	45,08	-	33,0	20,0	30	8	0,103
		<b>60 3M 15</b>	<b>03M1560</b>	6		60	57,30	56,54	-	33,0	20,0	30	8	0,150
		<b>72 3M 15</b>	<b>03M1572</b>	6		72	68,75	67,99	-	33,0	20,0	30	8	0,212

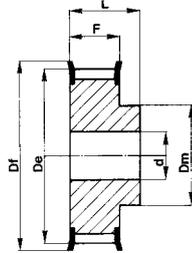

**Tipo / Type**  
**6F**

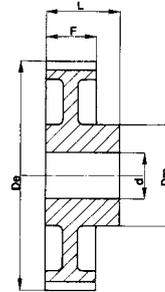

**Tipo / Type**  
**6W**

## HTD® 5M-09

Caratteristiche Features Merkmale Características	Codice Code symbol Fabriknummer Code symbole Numero de fabrica	Nostro codice Our code Unser code Notre code Nuestro codigo	Tipo Type Typ Type Tipo	Tipo flangia Flanges type Bordscheiben Typ Type flasques Tipo tapetas	N. denti N. of teeth Zahnezahl N. bre de dents Cantidad de dientes	Dp	De	Df	Dm	Di	F	L	Foro stock Stock bore Vor bohrung Alesage en stock Agujero de stock	Peso Weight / Gewicht Poids / Peso Kg
Acciaio / Steel / Stahl Acier / Acero  con flangia / with flanges mit Flanges / avec flasques con tapetas	<b>12 5M 09</b>	<b>05M0912</b>	6F	F07	12	19,10	17,96	23	12,0	-	14,5	20,0	4	0,028
	<b>14 5M 09</b>	<b>05M0914</b>	6F	F08	14	22,28	21,14	25	13,0	-	14,5	20,0	6	0,034
	<b>15 5M 09</b>	<b>05M0915</b>	6F	F09	15	23,87	22,73	28	16,0	-	14,5	20,0	6	0,042
	<b>16 5M 09</b>	<b>05M0916</b>	6F	F09	16	25,46	24,32	28	16,5	-	14,5	20,0	6	0,050
	<b>18 5M 09</b>	<b>05M0918</b>	6F	F10	18	28,65	27,51	32	20,0	-	14,5	20,0	6	0,070
	<b>20 5M 09</b>	<b>05M0920</b>	6F	F12	20	31,83	30,69	36	23,0	-	14,5	22,5	6	0,094
	<b>21 5M 09</b>	<b>05M0921</b>	6F	F14	21	33,42	32,28	38	24,0	-	14,5	22,5	6	0,110
	<b>22 5M 09</b>	<b>05M0922</b>	6F	F14	22	35,01	33,87	38	25,5	-	14,5	22,5	6	0,118
	<b>24 5M 09</b>	<b>05M0924</b>	6F	F15	24	38,20	37,06	42	27,0	-	14,5	22,5	6	0,145
	<b>26 5M 09</b>	<b>05M0926</b>	6F	F17	26	41,38	40,24	44	30,0	-	14,5	22,5	6	0,170
	<b>28 5M 09</b>	<b>05M0928</b>	6F	F18	28	44,56	43,42	48	30,5	-	14,5	22,5	6	0,200
	<b>30 5M 09</b>	<b>05M0930</b>	6F	F19	30	47,75	46,60	51	35,0	-	14,5	22,5	6	0,236
	<b>32 5M 09</b>	<b>05M0932</b>	6F	F20	32	50,93	49,79	54	38,0	-	14,5	22,5	8	0,210
	<b>36 5M 09</b>	<b>05M0936</b>	6F	F22	36	57,30	56,16	60	38,0	-	14,5	22,5	8	0,324
<b>40 5M 09</b>	<b>05M0940</b>	6F	F26	40	63,66	62,52	70	38,0	-	14,5	22,5	8	0,400	
<b>44 5M 09</b>	<b>05M0944</b>	6W		44	70,03	68,89	-	38,0	54	14,5	25,5	8	0,170	
Alluminio / Aluminium Aluminium / Aluminium Aluminio  senza flangia / without flanges / ohne Flanschen sans flasques / sin tapetas	<b>48 5M 09</b>	<b>05M0948</b>	6W		48	76,39	75,25	-	45,0	61	14,5	25,5	8	0,182
	<b>60 5M 09</b>	<b>05M0960</b>	6W		60	95,46	94,35	-	45,0	80	14,5	25,5	8	0,230
	<b>72 5M 09</b>	<b>05M0972</b>	6W		72	114,59	113,45	-	45,0	100	14,5	25,5	8	0,270



**Pulegge dentate per cinghie HTD® / Timing belt pulleys HTD®**  
**HTD® Zahnriemenscheiben / Poulies dentées HTD®**  
**Poleas para correas dentadas HTD®**



**HTD® 5M-15**

Caratteristiche Features Merkmale Características	Codice Code symbol Fabriknummer Code symbole Numero de fabrica	Nostro codice Our code Unser kode Notre code Nuestro codigo	Tipo Type Typ Type Tipo	Tipo flangia Flanges type Bordscheiben Typ Type flasques Tipo tapetas	N. denti N. of teeth Zahnezahl N. bre de dents Cantidad de dientes	Dp	De	Df	Dm	Di	F	L	Foro stock Stock bore Vor bohrung Alesage en stock Agujero de stock	Peso Weight / Gewicht Poids / Peso Kg
Acciaio / Steel / Stahl Acier / Acero  con flangia / with flanges mit Flanges / avec flasques con tapetas	<b>12 5M 15</b>	<b>05M1512</b>	6F	F07	12	19,10	17,96	23	12,0	-	20,5	26	4	0,034
	<b>14 5M 15</b>	<b>05M1514</b>	6F	F08	14	22,28	21,14	25	13,0	-	20,5	26	6	0,046
	<b>15 5M 15</b>	<b>05M1515</b>	6F	F09	15	23,87	22,73	28	16,0	-	20,5	26	6	0,056
	<b>16 5M 15</b>	<b>05M1516</b>	6F	F09	16	25,46	24,32	28	16,5	-	20,5	26	6	0,064
	<b>18 5M 15</b>	<b>05M1518</b>	6F	F10	18	28,65	27,51	32	20,0	-	20,5	26	6	0,086
	<b>20 5M 15</b>	<b>05M1520</b>	6F	F12	20	31,83	30,69	36	23,0	-	20,5	26	6	0,112
	<b>21 5M 15</b>	<b>05M1521</b>	6F	F14	21	33,42	32,28	38	24,0	-	20,5	26	6	0,130
	<b>22 5M 15</b>	<b>05M1522</b>	6F	F14	22	35,01	33,87	38	25,5	-	20,5	26	6	0,140
	<b>24 5M 15</b>	<b>05M1524</b>	6F	F15	24	38,20	37,06	42	27,0	-	20,5	28	6	0,180
	<b>26 5M 15</b>	<b>05M1526</b>	6F	F17	26	41,38	40,24	44	30,0	-	20,5	28	6	0,220
	<b>28 5M 15</b>	<b>05M1528</b>	6F	F18	28	44,56	43,42	48	30,5	-	20,5	28	6	0,250
	<b>30 5M 15</b>	<b>05M1530</b>	6F	F19	30	47,75	46,60	51	35,0	-	20,5	28	6	0,300
	<b>32 5M 15</b>	<b>05M1532</b>	6F	F20	32	50,93	49,79	54	38,0	-	20,5	28	8	0,350
	<b>36 5M 15</b>	<b>05M1536</b>	6F	F24	36	57,30	56,16	60	38,0	-	20,5	28	8	0,426
<b>40 5M 15</b>	<b>05M1540</b>	6F	F26	40	63,66	62,52	70	38,0	-	20,5	28	8	0,520	
Alluminio / Aluminium Aluminium / Aluminium Aluminio  senza flangia / without flanges / ohne Flanschen sans flasques / sin tapetas	<b>44 5M 15</b>	<b>05M1544</b>	6W		44	70,03	68,89	-	38,0	54	20,5	30	8	0,225
	<b>48 5M 15</b>	<b>05M1548</b>	6W		48	76,39	75,25	-	45,0	61	20,5	30	8	0,187
	<b>60 5M 15</b>	<b>05M1560</b>	6W		60	95,46	94,35	-	45,0	80	20,5	30	8	0,305
	<b>72 5M 15</b>	<b>05M1572</b>	6W		72	114,59	113,45	-	45,0	100	20,5	30	8	0,305

**HTD® 5M-25**

Caratteristiche Features Merkmale Características	Codice Code symbol Fabriknummer Code symbole Numero de fabrica	Nostro codice Our code Unser kode Notre code Nuestro codigo	Tipo Type Typ Type Tipo	Tipo flangia Flanges type Bordscheiben Typ Type flasques Tipo tapetas	N. denti N. of teeth Zahnezahl N. bre de dents Cantidad de dientes	Dp	De	Df	Dm	Di	F	L	Foro stock Stock bore Vor bohrung Alesage en stock Agujero de stock	Peso Weight / Gewicht Poids / Peso Kg
Acciaio / Steel / Stahl Acier / Acero  con flangia / with flanges mit Flanges / avec flasques con tapetas	<b>12 5M 25</b>	<b>05M2512</b>	6F	F07	12	19,10	17,96	23	12,0	-	30,5	36	4	0,050
	<b>14 5M 25</b>	<b>05M2514</b>	6F	F08	14	22,28	21,14	25	13,0	-	30,5	36	6	0,070
	<b>15 5M 25</b>	<b>05M2515</b>	6F	F09	15	23,87	22,73	28	16,0	-	30,5	36	6	0,080
	<b>16 5M 25</b>	<b>05M2516</b>	6F	F09	16	25,46	24,32	28	16,5	-	30,5	36	6	0,100
	<b>18 5M 25</b>	<b>05M2518</b>	6F	F10	18	28,65	27,51	32	20,0	-	30,5	36	6	0,120
	<b>20 5M 25</b>	<b>05M2520</b>	6F	F12	20	31,83	30,69	36	23,0	-	30,5	36	6	0,160
	<b>21 5M 25</b>	<b>05M2521</b>	6F	F14	21	33,42	32,28	38	24,0	-	30,5	38	6	0,190
	<b>22 5M 25</b>	<b>05M2522</b>	6F	F14	22	35,01	33,87	38	25,5	-	30,5	38	6	0,210
	<b>24 5M 25</b>	<b>05M2524</b>	6F	F15	24	38,20	37,06	42	27,0	-	30,5	38	6	0,250
	<b>26 5M 25</b>	<b>05M2526</b>	6F	F17	26	41,38	40,24	44	30,0	-	30,5	38	6	0,300
	<b>28 5M 25</b>	<b>05M2528</b>	6F	F18	28	44,56	43,42	48	30,5	-	30,5	38	6	0,350
	<b>30 5M 25</b>	<b>05M2530</b>	6F	F19	30	47,75	46,60	51	35,0	-	30,5	38	6	0,420
	<b>32 5M 25</b>	<b>05M2532</b>	6F	F20	32	50,93	49,79	54	38,0	-	30,5	38	8	0,480
	<b>36 5M 25</b>	<b>05M2536</b>	6F	F22	36	57,30	56,16	60	38,0	-	30,5	38	8	0,590
<b>40 5M 25</b>	<b>05M2540</b>	6F	F26	40	63,66	62,52	70	38,0	-	30,5	38	8	0,740	
Alluminio / Aluminium Aluminium / Aluminium Aluminio  senza flangia / without flanges / ohne Flanschen sans flasques / sin tapetas	<b>44 5M 15</b>	<b>05M2544</b>	6W		44	70,03	68,89	-	38,0	54	30,5	40	8	0,320
	<b>48 5M 15</b>	<b>05M2548</b>	6W		48	76,39	75,25	-	45,0	61	30,5	40	8	0,275
	<b>60 5M 15</b>	<b>05M2560</b>	6W		60	95,46	94,35	-	45,0	80	30,5	40	8	0,435
	<b>72 5M 15</b>	<b>05M2572</b>	6W		72	114,59	113,45	-	45,0	100	30,5	40	8	0,525

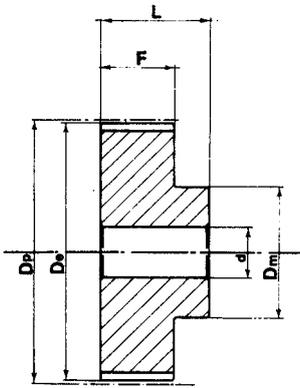

Tipo / Type  
6

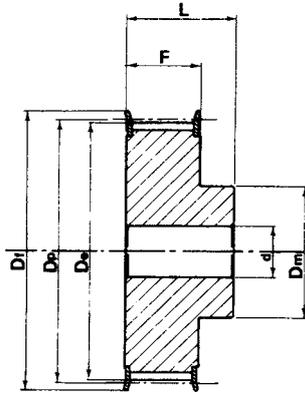

Tipo / Type  
6F

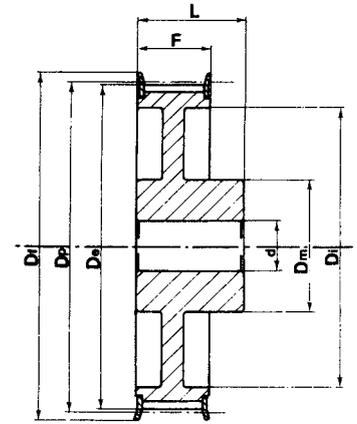

Tipo / Type  
6WF

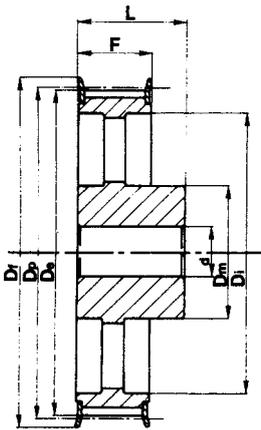

Tipo / Type  
6AF

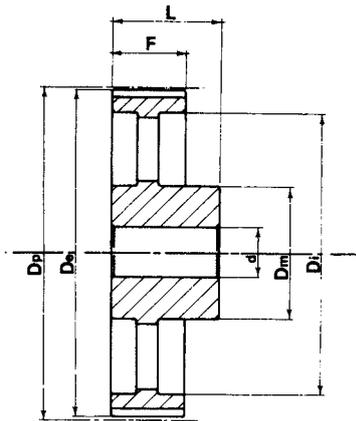

Tipo / Type  
6A

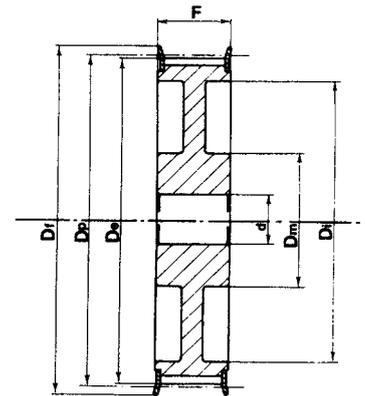

Tipo / Type  
10WF

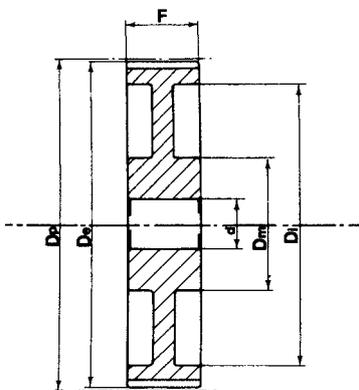

Tipo / Type  
10W

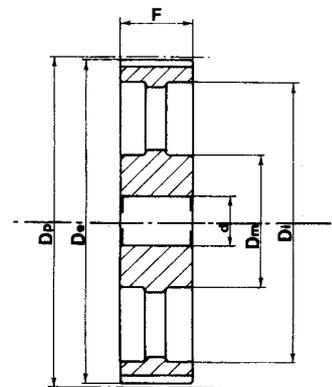

Tipo / Type  
10A

# Pulegge dentate per cinghie HTD® / Timing belt pulleys HTD®

## HTD® Zahnriemenscheiben / Poulies dentées HTD®

### Poleas para correas dentadas HTD®



## HTD® 8M-20

Caratteristiche Features Merkmale Características	Code Code symbol Fabriknummer Code symbole Numero de fabrica	Nostro codice Our code Unser kode Notre code Nuestro codigo	Tipo Type Typ Type Tipo	Tipo flangia Flanges type Bordscheiben Typ Type flasques Tipo tapetas	N. denti N. of teeth Zahnezahl N. bre de dents Cantidad de dientes	Dp	De	Df	Dm	Di	F	L	d	Peso Weight / Gewicht Poids / Peso Kg
Acciaio / Steel / Stahl Acier / Acero	22 8M 20	08M2022	6F	F22	22	56,02	54,65	60	43	-	28	38	12	0,54
	24 8M 20	08M2024	6F	F25	24	61,12	59,75	66	45	-	28	38	12	0,65
	26 8M 20	08M2026	6F	F26	26	66,21	64,84	70	48	-	28	38	12	0,80
	28 8M 20	08M2028	6F	F27	28	71,30	70,08	75	50	-	28	38	15	0,87
	30 8M 20	08M2030	6F	F29	30	76,39	75,13	83	55	-	28	38	15	1,02
	32 8M 20	08M2032	6F	F30	32	81,49	80,16	87	60	-	28	38	15	1,20
	34 8M 20	08M2034	6F	F31	34	86,58	85,22	91	70	-	28	38	15	1,40
	36 8M 20	08M2036	6F	F33	36	91,67	90,30	97	75	-	28	38	15	1,55
	38 8M 20	08M2038	6F	F34	38	96,77	95,39	102	75	-	28	38	15	1,65
	40 8M 20	08M2040	6F	F35	40	101,86	100,49	106	75	-	28	38	15	1,74
	44 8M 20	08M2044	6F	F38	44	112,05	110,67	120	75	-	28	38	15	2,10
	48 8M 20	08M2048	6F	F40	48	122,23	120,86	128	75	-	28	38	15	2,44
	56 8M 20	08M2056	6WF	F48	56	142,60	141,23	150	80	116	28	38	15	2,60
	64 8M 20	08M2064	6WF	F52	64	162,97	161,60	168	80	137	28	38	15	2,90
72 8M 20	08M2072	6WF	F57	72	183,35	181,97	192	80	158	28	38	15	3,10	
Ghisa / Cast iron Grauguss / Fonte Hierro fundido	80 8M 20	08M2080	6W		80	203,72	202,35	-	90	180	28	38	15	3,80
	90 8M 20	08M2090	6A		90	229,18	227,81	-	90	204	28	38	15	4,20
	112 8M 20	08M2011	6A		112	285,21	283,83	-	90	254	28	38	18	5,20
	144 8M 20	08M2014	6A		144	366,69	365,32	-	90	336	28	38	20	7,50
	168 8M 20	08M2016	6A		168	427,81	426,44	-	100	400	28	38	20	10,00
	192 8M 20	08M2019	6A		192	488,92	487,55	-	100	460	28	38	20	14,40

## HTD® 8M 30

Caratteristiche Features Merkmale Características	Code Code symbol Fabriknummer Code symbole Numero de fabrica	Nostro codice Our code Unser kode Notre code Nuestro codigo	Tipo Type Typ Type Tipo	Tipo flangia Flanges type Bordscheiben Typ Type flasques Tipo tapetas	N. denti N. of teeth Zahnezahl N. bre de dents Cantidad de dientes	Dp	De	Df	Dm	Di	F	L	d	Peso Weight / Gewicht Poids / Peso Kg
Acciaio / Steel / Stahl Acier / Acero	22 8M 30	08M3022	6F	F22	22	56,02	54,65	60	43	-	38	48	12	0,69
	24 8M 30	08M3024	6F	F25	24	61,12	59,75	66	45	-	38	48	12	0,84
	26 8M 30	08M3026	6F	F26	26	66,21	64,84	70	48	-	38	48	12	1,00
	28 8M 30	08M3028	6F	F27	28	71,30	70,08	75	50	-	38	48	15	1,12
	30 8M 30	08M3030	6F	F29	30	76,39	75,13	83	55	-	38	48	15	1,32
	32 8M 30	08M3032	6F	F30	32	81,49	80,16	87	60	-	38	48	15	1,53
	34 8M 30	08M3034	6F	F31	34	86,58	85,22	91	70	-	38	48	15	1,80
	36 8M 30	08M3036	6F	F33	36	91,67	90,30	97	75	-	38	48	15	1,99
	38 8M 30	08M3038	6F	F34	38	96,77	95,39	102	75	-	38	48	15	2,27
	40 8M 30	08M3040	6F	F35	40	101,86	100,49	106	75	-	38	48	15	2,40
	44 8M 30	08M3044	6F	F38	44	112,05	110,67	120	75	-	38	48	15	2,80
	48 8M 30	08M3048	6F	F40	48	122,23	120,86	128	75	-	38	48	15	3,20
	56 8M 30	08M3056	6WF	F48	56	142,60	141,23	150	90	116	38	48	15	3,60
	64 8M 30	08M3064	6WF	F52	64	162,97	161,60	168	90	137	38	48	15	4,30
72 8M 30	08M3072	6WF	F57	72	183,35	181,97	192	95	158	38	48	15	4,80	
Ghisa / Cast iron Grauguss / Fonte Hierro fundido	80 8M 30	08M3080	6W		80	203,72	202,35	-	100	180	38	48	15	5,10
	90 8M 30	08M3090	6A		90	229,18	227,81	-	100	204	38	48	15	5,70
	112 8M 30	08M3011	6A		112	285,21	283,83	-	100	254	38	48	18	6,80
	144 8M 30	08M3014	6A		144	366,69	365,32	-	100	336	38	48	20	9,30
	168 8M 30	08M3016	6A		168	427,81	426,44	-	100	400	38	48	20	11,40
	192 8M 30	08M3019	6A		192	488,92	487,55	-	100	460	38	48	20	16,00

### HTD® 8M-50

Caratteristiche Features Merkmale Características Características	Code Code symbol Fabriknummer Code symbole Numero de fabrica	Nostro codice Our code Unser kode Notre code Nuestro codigo	Tipo Type Typ Type Tipo	Tipo flangia Flanges type Bordscheiben Typ Type flasques Tipo tapetas	N. denti N. of teeth Zahnezahl N. bre de dents Cantidad de dientes	Dp	De	Df	Dm	Di	F	L	d	Peso Weight / Gewicht Poids / Peso Kg	
Acciaio / Steel / Stahl Acier / Acero	con flangia / with flanges mit Flanges / avec flasques con tapetas	<b>22 8M 50</b>	<b>08M5022</b>	6F	F22	22	56,02	54,65	60	43	-	60	70	12	1,00
		<b>24 8M 50</b>	<b>08M5024</b>	6F	F25	24	61,12	59,75	66	45	-	60	70	12	1,23
		<b>26 8M 50</b>	<b>08M5026</b>	6F	F26	26	66,21	64,84	70	48	-	60	70	15	1,50
		<b>28 8M 50</b>	<b>08M5028</b>	6F	F27	28	71,30	70,08	75	50	-	60	70	15	1,67
		<b>30 8M 50</b>	<b>08M5030</b>	6F	F29	30	76,39	75,13	83	55	-	60	70	15	1,97
		<b>32 8M 50</b>	<b>08M5032</b>	6F	F30	32	81,49	80,16	87	60	-	60	70	15	2,27
		<b>34 8M 50</b>	<b>08M5034</b>	6F	F31	34	86,58	85,22	91	66	-	60	70	15	2,69
		<b>36 8M 50</b>	<b>08M5036</b>	6F	F33	36	91,67	90,30	97	70	-	60	70	15	2,97
		<b>38 8M 50</b>	<b>08M5038</b>	6F	F34	38	96,77	95,39	102	75	-	60	70	15	3,23
		<b>40 8M 50</b>	<b>08M5040</b>	6F	F35	40	101,86	100,49	106	75	-	60	70	18	3,50
		<b>44 8M 50</b>	<b>08M5044</b>	6F	F38	44	112,05	110,67	120	75	-	60	70	18	3,90
		<b>48 8M 50</b>	<b>08M5048</b>	6F	F40	48	122,23	120,86	128	80	-	60	70	18	4,30
		<b>56 8M 50</b>	<b>08M5056</b>	10WF	F48	56	142,60	141,23	150	90	116	60	60	18	5,00
		<b>64 8M 50</b>	<b>08M5064</b>	10WF	F52	64	162,97	161,60	168	100	137	60	60	18	5,60
<b>72 8M 50</b>	<b>08M5072</b>	10WF	F57	72	183,35	181,97	192	100	158	60	60	18	6,80		
Ghisa / Cast iron Grauguss / Fonte Hierro fundido	senza flangia / without flanges / ohne Flanschen sans flasques / sin tapetas	<b>80 8M 50</b>	<b>08M5080</b>	10W		80	203,72	202,35	-	110	180	60	60	18	6,90
		<b>90 8M 50</b>	<b>08M5090</b>	10A		90	229,18	227,81	-	110	204	60	60	18	8,60
		<b>112 8M 50</b>	<b>08M5011</b>	10A		112	285,21	283,83	-	110	254	60	60	18	9,60
		<b>144 8M 50</b>	<b>08M5014</b>	10A		144	366,69	365,32	-	110	336	60	60	20	13,80
		<b>168 8M 50</b>	<b>08M5016</b>	10A		168	427,81	426,44	-	120	400	60	60	20	16,00
		<b>192 8M 50</b>	<b>08M5019</b>	10A		192	488,92	487,55	-	130	460	60	60	20	22,40

### HTD® 8M-85

Caratteristiche Features Merkmale Características Características	Code Code symbol Fabriknummer Code symbole Numero de fabrica	Nostro codice Our code Unser kode Notre code Nuestro codigo	Tipo Type Typ Type Tipo	Tipo flangia Flanges type Bordscheiben Typ Type flasques Tipo tapetas	N. denti N. of teeth Zahnezahl N. bre de dents Cantidad de dientes	Dp	De	Df	Dm	Di	F	L	d	Peso Weight / Gewicht Poids / Peso Kg	
Acciaio / Steel / Stahl Acier / Acero	con flangia / with flanges mit Flanges / avec flasques con tapetas	<b>22 8M 85</b>	<b>08M8522</b>	6F	F22	22	56,02	54,65	60	43	-	95	105	12	1,55
		<b>24 8M 85</b>	<b>08M8524</b>	6F	F25	24	61,12	59,75	66	45	-	95	105	12	1,90
		<b>26 8M 85</b>	<b>08M8526</b>	6F	F26	26	66,21	64,84	70	48	-	95	105	12	2,25
		<b>28 8M 85</b>	<b>08M8528</b>	6F	F27	28	71,30	70,08	75	50	-	95	105	15	2,55
		<b>30 8M 85</b>	<b>08M8530</b>	6F	F29	30	76,39	75,13	83	55	-	95	105	15	3,00
		<b>32 8M 85</b>	<b>08M8532</b>	6F	F30	32	81,49	80,16	87	60	-	95	105	15	3,57
		<b>34 8M 85</b>	<b>08M8534</b>	6F	F31	34	86,58	85,22	91	66	-	95	105	15	4,00
		<b>36 8M 85</b>	<b>08M8536</b>	6F	F33	36	91,67	90,30	97	70	-	95	105	15	4,50
		<b>38 8M 85</b>	<b>08M8538</b>	6F	F34	38	96,77	95,39	102	75	-	95	105	15	5,00
		<b>40 8M 85</b>	<b>08M8540</b>	6F	F35	40	101,86	100,49	106	75	-	95	105	18	5,20
		<b>44 8M 85</b>	<b>08M8544</b>	6F	F38	44	112,05	110,67	120	75	-	95	105	18	6,60
		<b>48 8M 85</b>	<b>08M8548</b>	6F	F40	48	122,23	120,86	128	80	-	95	105	18	7,00
		<b>56 8M 85</b>	<b>08M8556</b>	6F	F48	56	142,60	141,23	150	90	-	95	105	18	10,00
		<b>64 8M 85</b>	<b>08M8564</b>	10WF	F52	64	162,97	161,60	168	100	137	95	95	20	10,40
Ghisa / Cast iron Grauguss / Fonte Hierro fundido	senza flangia / without flanges / ohne Flanschen sans flasques / sin tapetas	<b>72 8M 85</b>	<b>08M8572</b>	10WF	F57	72	183,35	181,97	192	100	158	95	95	20	11,40
		<b>80 8M 85</b>	<b>08M8580</b>	10W		80	203,72	202,35	-	110	180	95	95	20	11,10
		<b>90 8M 85</b>	<b>08M8590</b>	10A		90	229,18	227,81	-	110	204	95	95	20	12,20
		<b>112 8M 85</b>	<b>08M8511</b>	10A		112	285,21	283,83	-	110	254	95	95	24	15,00
		<b>144 8M 85</b>	<b>08M8514</b>	10A		144	366,69	365,32	-	110	336	95	95	24	21,50
		<b>168 8M 85</b>	<b>08M8516</b>	10A		168	427,81	426,44	-	120	400	95	95	24	24,10
		<b>192 8M 85</b>	<b>08M8519</b>	10A		192	488,92	487,55	-	130	460	95	95	24	30,60

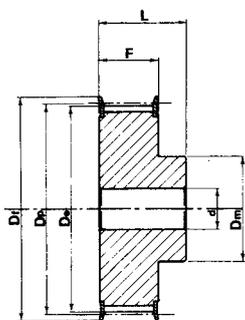

**Tipo / Type**  
**6F**

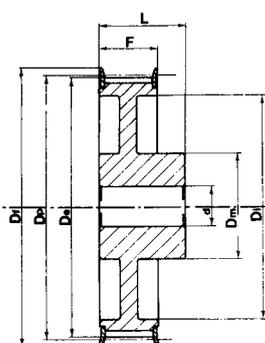

**Tipo / Type**  
**6WF**

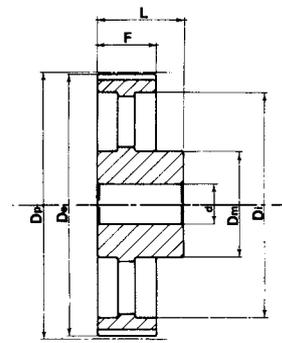

**Tipo / Type**  
**6A**

## HTD® 14M-40

Caratteristiche Features Merkmale Caractéristiques Características	Codice Code symbol Fabriknummer Code symbole Numero de fabrica	Nostro codice Our code Unser kode Notre code Nuestro codigo	Tipo Type Typ Type Tipo	Tipo flangia Flanges type Bordscheiben Typ Type flasques Tipo tapetas	N. denti N. of teeth Zahnezahl N. bre de dents Cantidad de dientes	Dp	De	Df	Dm	Di	F	L	d	Peso Weight / Gewicht Poids / Peso Kg
Acciaio / Steel / Stahl Acier / Acero	<b>28 14M 40</b>	<b>14M4028</b>	6F	F40	28	124,78	122,12	128	100	-	54	69	24	4,73
	<b>29 14M 40</b>	<b>14M4029</b>	6F	F43	29	129,23	126,57	138	100	-	54	69	24	5,09
	<b>30 14M 40</b>	<b>14M4030</b>	6F	F43	30	133,69	130,99	138	100	-	54	69	24	5,45
	<b>32 14M 40</b>	<b>14M4032</b>	6F	F49	32	142,60	139,88	154	100	-	54	69	24	6,17
	<b>34 14M 40</b>	<b>14M4034</b>	6F	F51	34	151,52	148,79	160	100	-	54	69	24	6,88
	<b>36 14M 40</b>	<b>14M4036</b>	6F	F52	36	160,43	157,68	168	100	-	54	69	24	7,60
	<b>38 14M 40</b>	<b>14M4038</b>	6F	F81	38	169,34	166,60	184	120	-	54	69	24	8,28
	<b>40 14M 40</b>	<b>14M4040</b>	6F	F56	40	178,25	175,49	188	120	-	54	69	24	9,26
	<b>44 14M 40</b>	<b>14M4044</b>	6F	F61	44	196,08	193,28	212	120	-	54	69	24	10,32
Ghisa / Cast iron Grauguss / Fonte Hierro fundido	<b>48 14M 40</b>	<b>14M4048</b>	6WF	F62	48	213,90	211,11	226	135	170	54	69	24	11,50
	<b>56 14M 40</b>	<b>14M4056</b>	6WF	F66	56	249,55	246,76	256	135	207	54	69	28	13,05
	<b>64 14M 40</b>	<b>14M4064</b>	6WF	F70	64	285,21	282,41	296	135	240	54	69	28	14,40
	<b>72 14M 40</b>	<b>14M4072</b>	6A		72	320,86	318,06	-	135	278	54	69	28	16,90
	<b>80 14M 40</b>	<b>14M4080</b>	6A		80	356,51	353,71	-	135	314	54	69	28	18,50
	<b>90 14M 40</b>	<b>14M4090</b>	6A		90	401,07	398,28	-	135	358	54	69	28	20,00
	<b>112 14M 40</b>	<b>14M4011</b>	6A		112	499,11	496,32	-	135	456	54	69	28	26,70
	<b>144 14M 40</b>	<b>14M4014</b>	6A		144	641,71	638,92	-	135	600	54	69	28	35,00
	<b>168 14M 40</b>	<b>14M4016</b>	6A		168	748,66	745,87	-	135	706	54	69	28	44,20
	<b>192 14M 40</b>	<b>14M4019</b>	6A		192	855,62	852,82	-	135	813	54	69	28	52,20
<b>216 14M 40</b>	<b>14M4021</b>	6A		216	962,57	959,76	-	150	920	54	69	28	62,50	

### HTD® 14M-55

Caratteristiche Features Merkmal Características	Codice Code symbol Fabriknummer Code symbole Numero de fabrica	Nostro codice Our code Unser kode Notre code Nuestro codigo	Tipo Type Typ Type Tipo	Tipo flangia Flanges type Bordscheiben Typ Type flasques Tipo tapetas	N. denti N. of teeth Zahnezahl N. bre de dents Cantidad de dientes	Dp	De	Df	Dm	Di	F	L	d	Peso Weight / Gewicht Poids / Peso Kg	
Acciaio / Steel / Stahl Acier / Acero	con flangia / with flanges mit Flanges / avec flasques con tapetas	<b>28 14M 55</b>	<b>14M5528</b>	6F	F40	28	124,78	122,12	128	100	-	70	85	24	5,60
		<b>29 14M 55</b>	<b>14M5529</b>	6F	F43	29	129,23	126,57	138	100	-	70	85	24	6,10
		<b>30 14M 55</b>	<b>14M5530</b>	6F	F43	30	133,69	130,99	138	100	-	70	85	24	6,60
		<b>32 14M 55</b>	<b>14M5532</b>	6F	F49	32	142,60	139,88	154	100	-	70	85	24	7,60
		<b>34 14M 55</b>	<b>14M5534</b>	6F	F51	34	151,52	148,79	160	100	-	70	85	24	8,60
		<b>36 14M 55</b>	<b>14M5536</b>	6F	F52	36	160,43	157,68	168	100	-	70	85	24	9,60
		<b>38 14M 55</b>	<b>14M5538</b>	6F	F81	38	169,34	166,60	184	120	-	70	85	24	10,80
		<b>40 14M 55</b>	<b>14M5540</b>	6F	F56	40	178,25	175,49	188	120	-	70	85	24	11,20
		<b>44 14M 55</b>	<b>14M5544</b>	6F	F61	44	196,08	193,28	212	120	-	70	85	24	12,50
Ghisa / Cast iron Grauguss / Fonte Hierro fundido	senza flangia / without flanges / ohne Flanschen sans flasques / sin tapetas	<b>48 14M 55</b>	<b>14M5548</b>	10WF	F62	48	213,90	211,11	226	135	170	70	70	24	13,70
		<b>56 14M 55</b>	<b>14M5556</b>	10WF	F66	56	249,55	246,76	256	135	207	70	70	28	14,50
		<b>64 14M 55</b>	<b>14M5564</b>	10WF	F70	64	285,21	282,41	296	135	240	70	70	28	15,60
		<b>72 14M 55</b>	<b>14M5572</b>	10A		72	320,86	318,06	-	135	278	70	70	28	16,90
		<b>80 14M 55</b>	<b>14M5580</b>	10A		80	356,51	353,71	-	135	314	70	70	28	20,00
		<b>90 14M 55</b>	<b>14M5590</b>	10A		90	401,07	398,28	-	135	358	70	70	28	22,60
		<b>112 14M 55</b>	<b>14M5511</b>	10A		112	499,11	496,32	-	135	456	70	70	28	29,50
		<b>144 14M 55</b>	<b>14M5514</b>	10A		144	641,71	638,92	-	135	600	70	70	28	39,00
		<b>168 14M 55</b>	<b>14M5516</b>	10A		168	748,66	745,87	-	135	706	70	70	28	48,50
<b>192 14M 55</b>	<b>14M5519</b>	10A		192	855,62	852,82	-	135	813	70	70	28	57,80		
<b>216 14M 55</b>	<b>14M5521</b>	10A		216	962,57	959,76	-	150	920	70	70	28	67,00		

### HTD® 14M-85

Caratteristiche Features Merkmal Características	Codice Code symbol Fabriknummer Code symbole Numero de fabrica	Nostro codice Our code Unser kode Notre code Nuestro codigo	Tipo Type Typ Type Tipo	Tipo flangia Flanges type Bordscheiben Typ Type flasques Tipo tapetas	N. denti N. of teeth Zahnezahl N. bre de dents Cantidad de dientes	Dp	De	Df	Dm	Di	F	L	d	Peso Weight / Gewicht Poids / Peso Kg	
Acciaio / Steel / Stahl Acier / Acero	con flangia / with flanges mit Flanges / avec flasques con tapetas	<b>28 14M 85</b>	<b>14M8528</b>	6F	F40	28	124,78	122,12	128	100	-	102	117	24	7,70
		<b>29 14M 85</b>	<b>14M8529</b>	6F	F43	29	129,23	126,57	138	100	-	102	117	24	8,40
		<b>30 14M 85</b>	<b>14M8530</b>	6F	F43	30	133,69	130,99	138	100	-	102	117	24	9,10
		<b>32 14M 85</b>	<b>14M8532</b>	6F	F49	32	142,60	139,88	154	100	-	102	117	24	10,50
		<b>34 14M 85</b>	<b>14M8534</b>	6F	F51	34	151,52	148,79	160	100	-	102	117	24	11,90
		<b>36 14M 85</b>	<b>14M8536</b>	6F	F52	36	160,43	157,68	168	100	-	102	117	32	13,20
		<b>38 14M 85</b>	<b>14M8538</b>	6F	F81	38	169,34	166,60	184	120	-	102	117	32	15,15
		<b>40 14M 85</b>	<b>14M8540</b>	6F	F56	40	178,25	175,49	188	135	-	102	117	32	17,10
		<b>44 14M 85</b>	<b>14M8544</b>	6F	F61	44	196,08	193,28	212	135	-	102	117	32	23,30
<b>48 14M 85</b>	<b>14M8548</b>	6F	F62	48	213,90	211,11	226	150	-	102	117	32	25,00		
Ghisa / Cast iron Grauguss / Fonte Hierro fundido	senza flangia / without flanges / ohne Flanschen sans flasques / sin tapetas	<b>56 14M 85</b>	<b>14M8556</b>	10WF	F66	56	249,55	246,76	256	150	207	102	117	32	25,00
		<b>64 14M 85</b>	<b>14M8564</b>	10WF	F70	64	285,21	282,41	296	150	240	102	102	32	30,50
		<b>72 14M 85</b>	<b>14M8572</b>	10A		72	320,86	318,06	-	150	278	102	102	32	28,80
		<b>80 14M 85</b>	<b>14M8580</b>	10A		80	356,51	353,71	-	150	314	102	102	32	30,10
		<b>90 14M 85</b>	<b>14M8590</b>	10A		90	401,07	398,28	-	150	358	102	102	32	33,00
		<b>112 14M 85</b>	<b>14M8511</b>	10A		112	499,11	496,32	-	150	456	102	102	32	41,80
		<b>144 14M 85</b>	<b>14M8514</b>	10A		144	641,71	638,92	-	150	600	102	102	32	52,40
		<b>168 14M 85</b>	<b>14M8516</b>	10A		168	748,66	745,87	-	150	706	102	102	32	60,30
		<b>192 14M 85</b>	<b>14M8519</b>	10A		192	855,62	852,82	-	165	813	102	102	32	70,20
<b>216 14M 85</b>	<b>14M8521</b>	10A		216	962,57	959,76	-	165	920	102	102	32	81,00		

## HTD® 14M-115

Caratteristiche Features Merkmal Características	Codice Code symbol Fabriknummer Code symbole Numero de fabrica	Nostro codice Our code Unser kode Notre code Nuestro codigo	Tipo Type Typ Type Tipo	Tipo flangia Flanges type Bordscheiben Typ Type flasques Tipo tapetas	N. denti N. of teeth Zahnezahl N. bre de dents Cantidad de dientes	Dp	De	Df	Dm	Di	F	L	d	Peso Weight / Gewicht Poids / Peso Kg	
Acciaio / Steel / Stahl Acier / Acero	con flangia / with flanges mit Flanges / avec flasques con tapetas	<b>28 14M 115</b>	<b>14M1128</b>	6F	F40	28	124,78	122,12	128	100	-	133	148	32	9,20
	<b>29 14M 115</b>	<b>14M1129</b>	6F	F43	29	129,23	126,57	138	100	-	133	148	32	10,20	
	<b>30 14M 115</b>	<b>14M1130</b>	6F	F43	30	133,69	130,99	138	100	-	133	148	32	11,20	
	<b>32 14M 115</b>	<b>14M1132</b>	6F	F49	32	142,60	139,88	154	100	-	133	148	32	13,20	
	<b>34 14M 115</b>	<b>14M1134</b>	6F	F51	34	151,52	148,79	160	100	-	133	148	32	14,80	
	<b>36 14M 115</b>	<b>14M1136</b>	6F	F52	36	160,43	157,68	168	100	-	133	148	32	16,60	
	<b>38 14M 115</b>	<b>14M1138</b>	6F	F81	38	169,34	166,60	184	120	-	133	148	32	19,20	
	<b>40 14M 115</b>	<b>14M1140</b>	6F	F56	40	178,25	175,49	188	135	-	133	148	32	20,56	
	<b>44 14M 115</b>	<b>14M1144</b>	6F	F61	44	196,08	193,28	212	140	-	133	148	32	21,93	
	<b>48 14M 115</b>	<b>14M1148</b>	6F	F62	48	213,90	211,11	226	150	-	133	148	32	25,00	
	<b>56 14M 115</b>	<b>14M1156</b>	6F	F66	56	249,55	246,76	256	150	-	133	148	32	27,50	
	<b>64 14M 115</b>	<b>14M1164</b>	10WF	F70	64	285,21	282,41	296	150	240	133	133	32	30,10	
Ghisa / Cast iron Grauguss / Fonte Hierro fundido	senza flangia / without flanges / ohne Flanschen sans flasques / sin tapetas	<b>72 14M 115</b>	<b>14M1172</b>	10A		72	320,86	318,06	-	150	278	133	133	32	32,83
	<b>80 14M 115</b>	<b>14M1180</b>	10A		80	356,51	353,71	-	150	314	133	133	32	35,55	
	<b>90 14M 115</b>	<b>14M1190</b>	10A		90	401,07	398,28	-	150	358	133	133	32	41,00	
	<b>112 14M 115</b>	<b>14M1111</b>	10A		112	499,11	496,32	-	150	456	133	133	32	54,40	
	<b>144 14M 115</b>	<b>14M1114</b>	10A		144	641,71	638,92	-	165	600	133	133	32	67,80	
	<b>168 14M 115</b>	<b>14M1116</b>	10A		168	748,66	745,87	-	165	706	133	133	32	75,80	
	<b>192 14M 115</b>	<b>14M1119</b>	10A		192	855,62	852,82	-	165	813	133	133	32	88,30	
	<b>216 14M 115</b>	<b>14M1121</b>	10A		216	962,57	959,76	-	165	920	133	133	32	98,00	

## HTD® 14M-170

Caratteristiche Features Merkmal Características	Codice Code symbol Fabriknummer Code symbole Numero de fabrica	Nostro codice Our code Unser kode Notre code Nuestro codigo	Tipo Type Typ Type Tipo	Tipo flangia Flanges type Bordscheiben Typ Type flasques Tipo tapetas	N. denti N. of teeth Zahnezahl N. bre de dents Cantidad de dientes	Dp	De	Df	Dm	Di	F	L	d	Peso Weight / Gewicht Poids / Peso Kg	
Acciaio / Steel / Stahl Acier / Acero	con flangia / with flanges mit Flanges / avec flasques con tapetas	<b>28 14M 170</b>	<b>14M1728</b>	6F	F40	28	124,78	122,12	128	100	-	187	202	32	9,20
	<b>29 14M 170</b>	<b>14M1729</b>	6F	F43	29	129,23	126,57	138	100	-	187	202	32	10,20	
	<b>30 14M 170</b>	<b>14M1730</b>	6F	F43	30	133,69	130,99	138	100	-	187	202	32	11,20	
	<b>32 14M 170</b>	<b>14M1732</b>	6F	F49	32	142,60	139,88	154	100	-	187	202	32	13,20	
	<b>34 14M 170</b>	<b>14M1734</b>	6F	F51	34	151,52	148,79	160	100	-	187	202	32	14,80	
	<b>36 14M 170</b>	<b>14M1736</b>	6F	F52	36	160,43	157,68	168	100	-	187	202	32	16,60	
	<b>38 14M 170</b>	<b>14M1738</b>	6F	F81	38	169,34	166,60	184	120	-	187	202	32	19,20	
	<b>40 14M 170</b>	<b>14M1740</b>	6F	F56	40	178,25	175,49	188	135	-	187	202	32	20,56	
	<b>44 14M 170</b>	<b>14M1744</b>	6F	F61	44	196,08	193,28	212	140	-	187	202	32	21,93	
	<b>48 14M 170</b>	<b>14M1748</b>	6F	F62	48	213,90	211,11	226	150	-	187	202	32	25,00	
	<b>56 14M 170</b>	<b>14M1756</b>	6F	F66	56	249,55	246,76	256	150	-	187	202	32	27,50	
	<b>64 14M 170</b>	<b>14M1764</b>	10WF	F70	64	285,21	282,41	296	150	240	187	202	32	30,10	
Ghisa / Cast iron Grauguss / Fonte Hierro fundido	senza flangia / without flanges / ohne Flanschen sans flasques / sin tapetas	<b>72 14M 170</b>	<b>14M1772</b>	10A		72	320,86	318,06	-	150	278	187	187	32	32,83
	<b>80 14M 170</b>	<b>14M1780</b>	10A		80	356,51	353,71	-	150	314	187	187	32	35,55	
	<b>90 14M 170</b>	<b>14M1790</b>	10A		90	401,07	398,28	-	150	358	187	187	32	41,00	
	<b>112 14M 170</b>	<b>14M1711</b>	10A		112	499,11	496,32	-	150	456	187	187	32	54,40	
	<b>144 14M 170</b>	<b>14M1714</b>	10A		144	641,71	638,92	-	165	600	187	187	32	67,80	
	<b>168 14M 170</b>	<b>14M1716</b>	10A		168	748,66	745,87	-	165	706	187	187	32	75,80	
	<b>192 14M 170</b>	<b>14M1719</b>	10A		192	855,62	852,82	-	165	813	187	187	32	88,30	
	<b>216 14M 170</b>	<b>14M1721</b>	10A		216	962,57	959,76	-	165	920	187	187	32	98,00	

### HTD® 20M-115

Caratteristiche Features Merkmale Características Características	Codice Code symbol Fabriknummer Code symbole Numero de fabrica	Nostro codice Our code Unser code Notre code Nuestro codigo	Tipo Type Typ Type Tipo	Tipo flangia Flanges type Bordscheiben Typ Type flasques Tipo tapetas	N. denti N. of teeth Zahnezahl N. bre de dents Cantidad de dientes	Dp	De	Df	Dm	Di	F	L	e	d	Peso Weight / Gewicht Poids / Peso Kg	
Ghisa / Cast iron / Grauguss / Fonte / Hierro fundido	con flangia / with flanges mit Flanges / avec flasques con tapetas	<b>34 20M 115</b>	<b>20M1134</b>	6F	F64	34	216,45	212,13	240	165	-	136,5	168,5	-	32	39
		<b>36 20M 115</b>	<b>20M1136</b>	6F	F65	36	229,18	224,87	250	178	-	136,5	168,5	-	32	44
		<b>38 20M 115</b>	<b>20M1138</b>	6F	F67	38	241,92	237,60	265	181	-	136,5	168,5	-	32	49
		<b>40 20M 115</b>	<b>20M1140</b>	6F	F68	40	254,65	250,33	275	203	-	136,5	168,5	-	32	
		<b>44 20M 115</b>	<b>20M1144</b>	6F	F71	44	280,11	275,79	300	210	-	136,5	168,5	-	32	
		<b>48 20M 115</b>	<b>20M1148</b>	6F	F72	48	305,58	301,26	325	228	-	136,5	168,5	-	32	
		<b>52 20M 115</b>	<b>20M1152</b>	6F	F73	52	331,04	326,72	350	228	-	136,5	168,5	-	32	
		<b>56 20M 115</b>	<b>20M1156</b>	6F	F74	56	356,51	352,19	375	228	-	136,5	168,5	-	32	
		<b>60 20M 115</b>	<b>20M1160</b>	6WF	F75	60	381,97	377,65	405	228	318	136,5	168,5	-	38	
		<b>64 20M 115</b>	<b>20M1164</b>	6WF	F76	64	407,44	403,12	430	228	343	136,5	168,5	-	38	
		<b>68 20M 115</b>	<b>20M1168</b>	6WF	F77	68	432,90	428,58	455	228	366	136,5	168,5	-	38	
		<b>72 20M 115</b>	<b>20M1172</b>	6AF	F78	72	458,37	454,05	480	228	435	136,5	168,5	-	38	
		<b>80 20M 115</b>	<b>20M1180</b>	6AF	F79	80	509,30	504,98	530	280	445	136,5	168,5	-	38	
		<b>90 20M 115</b>	<b>20M1190</b>	6AF	F80	90	572,96	568,64	595	280	508	136,5	168,5	-	38	
		senza flangia / without flanges / ohne Flanschen sans flasques / sin tapetas	<b>112 20M 115</b>	<b>20M1111</b>	6A		112	713,01	708,70	-	280	648	136,5	168,5	-	38
<b>144 20M 115</b>	<b>20M1114</b>		6A		144	916,73	912,41	-	300	852	136,5	168,5	-	44		
<b>168 20M 115</b>	<b>20M1116</b>		6A		168	1069,52	1065,21	-	300	1005	136,5	168,5	-	44		
<b>192 20M 115</b>	<b>20M1119</b>		6A		192	1222,31	1218,00	-	300	1158	136,5	168,5	-	48		
<b>216 20M 115</b>	<b>20M1121</b>		6A		216	1375,10	1370,78	-	300	1300	136,5	168,5	-	48		

### HTD® 20M-170

Caratteristiche Features Merkmale Características Características	Codice Code symbol Fabriknummer Code symbole Numero de fabrica	Nostro codice Our code Unser code Notre code Nuestro codigo	Tipo Type Typ Type Tipo	Tipo flangia Flanges type Bordscheiben Typ Type flasques Tipo tapetas	N. denti N. of teeth Zahnezahl N. bre de dents Cantidad de dientes	Dp	De	Df	Dm	Di	F	L	e	d	Peso Weight / Gewicht Poids / Peso Kg	
Ghisa / Cast iron / Grauguss / Fonte / Hierro fundido	con flangia / with flanges mit Flanges / avec flasques con tapetas	<b>34 20M 170</b>	<b>20M1734</b>	6F	F64	34	216,45	212,13	240	165	-	190,5	222,5	-	32	44,8
		<b>36 20M 170</b>	<b>20M1736</b>	6F	F65	36	229,18	224,87	250	178	-	190,5	222,5	-	32	50,5
		<b>38 20M 170</b>	<b>20M1738</b>	6F	F67	38	241,92	237,60	265	181	-	190,5	222,5	-	32	55,0
		<b>40 20M 170</b>	<b>20M1740</b>	6F	F68	40	254,65	250,33	275	203	-	190,5	222,5	-	32	
		<b>44 20M 170</b>	<b>20M1744</b>	6F	F71	44	280,11	275,79	300	210	-	190,5	222,5	-	32	
		<b>48 20M 170</b>	<b>20M1748</b>	6F	F72	48	305,58	301,26	325	240	-	190,5	222,5	-	32	
		<b>52 20M 170</b>	<b>20M1752</b>	6F	F73	52	331,04	326,72	350	280	-	190,5	222,5	-	32	
		<b>56 20M 170</b>	<b>20M1756</b>	6F	F74	56	356,51	352,19	375	280	-	190,5	222,5	-	32	
		<b>60 20M 170</b>	<b>20M1760</b>	6F	F75	60	381,97	377,65	405	280	-	190,5	222,5	-	38	
		<b>64 20M 170</b>	<b>20M1764</b>	6F	F76	64	407,44	403,12	430	280	-	190,5	222,5	-	38	
		<b>68 20M 170</b>	<b>20M1768</b>	6F	F77	68	432,90	428,58	455	280	-	190,5	222,5	-	38	
		<b>72 20M 170</b>	<b>20M1772</b>	10AF	F78	72	458,37	454,05	480	280	394	190,5	190,5	-	38	
		<b>80 20M 170</b>	<b>20M1780</b>	10AF	F79	80	509,30	504,98	530	280	445	190,5	190,5	-	38	
		<b>90 20M 170</b>	<b>20M1790</b>	10AF	F80	90	572,96	568,64	595	280	508	190,5	190,5	-	38	
		senza flangia / without flanges / ohne Flanschen sans flasques / sin tapetas	<b>112 20M 170</b>	<b>20M1711</b>	10A		112	713,01	708,70	-	300	648	190,5	190,5	-	38
<b>144 20M 170</b>	<b>20M1714</b>		10A		144	916,73	912,41	-	300	852	190,5	190,5	-	44		
<b>168 20M 170</b>	<b>20M1716</b>		10A		168	1069,52	1065,21	-	350	1005	190,5	190,5	-	44		
<b>192 20M 170</b>	<b>20M1719</b>		10A		192	1222,31	1218,00	-	350	1158	190,5	190,5	-	48		
<b>216 20M 170</b>	<b>20M1721</b>		10A		216	1375,10	1370,78	-	350	1300	190,5	190,5	-	48		



**Pulegge dentate per cinghie HTD® / Timing belt pulleys HTD®**  
**HTD® Zahnriemenscheiben / Poulies dentées HTD®**  
**Poleas para correas dentadas HTD®**



**HTD® 20M-230**

Caratteristiche Features Merkmal Características	Codice Code symbol Fabriknummer Code symbole Numero de fabrica	Nostro codice Our code Unser kode Notre code Nuestro codigo	Tipo Type Typ Type Tipo	Tipo flangia Flanges type Bordscheiben Typ Type flasques Tipo tapetas	N. denti N. of teeth Zahnezahl N. bre de dents Cantidad de dientes	Dp	De	Df	Dm	Di	F	L	e	d	Peso Weight / Gewicht Poids / Peso Kg	
Ghisa / Cast iron / Grauguss / Fonte / Hierro fundido	con flangia / with flanges mit Flanges / avec flasques con tapetas	<b>38 20M 230</b>	<b>20M2338</b>	6F	F67	38	241,92	237,60	265	181	-	250,8	282,8	-	38	67,5
	<b>40 20M 230</b>	<b>20M2340</b>	6F	F68	40	254,65	250,33	275	203	-	250,8	282,8	-	38		
	<b>44 20M 230</b>	<b>20M2344</b>	6F	F71	44	280,11	275,79	300	210	-	250,8	282,8	-	38		
	<b>48 20M 230</b>	<b>20M2348</b>	6F	F72	48	305,58	301,26	325	228	-	250,8	282,8	-	38		
	<b>52 20M 230</b>	<b>20M2352</b>	6F	F73	52	331,04	326,72	350	280	-	250,8	282,8	-	38		
	<b>56 20M 230</b>	<b>20M2356</b>	6F	F74	56	356,51	352,19	375	280	-	250,8	282,8	-	32		
	<b>60 20M 230</b>	<b>20M2360</b>	6F	F75	60	381,97	377,65	405	280	-	250,8	282,8	-	38		
	<b>64 20M 230</b>	<b>20M2364</b>	6F	F76	64	407,44	403,12	430	300	-	250,8	282,8	-	38		
	<b>68 20M 230</b>	<b>20M2368</b>	6F	F77	68	432,90	428,58	455	300	-	250,8	282,8	-	38		
	<b>72 20M 230</b>	<b>20M2372</b>	6F	F78	72	458,37	454,05	480	300	-	250,8	282,8	-	38		
	<b>80 20M 230</b>	<b>20M2380</b>	10WF	F79	80	509,30	504,98	530	300	445	250,8	250,8	-	38		
<b>90 20M 230</b>	<b>20M2390</b>	10AF	F80	90	572,96	568,64	595	300	508	250,8	250,8	-	38			
senza flangia / without flanges / ohne Flanschen sans flasques / sin tapetas	<b>112 20M 230</b>	<b>20M2311</b>	10A		112	713,01	708,70	-	300	648	250,8	250,8	-	38		
	<b>144 20M 230</b>	<b>20M2314</b>	10A		144	916,73	912,41	-	350	852	250,8	250,8	-	44		
	<b>168 20M 230</b>	<b>20M2316</b>	10A		168	1069,52	1065,21	-	350	1005	250,8	250,8	-	44		
	<b>192 20M 230</b>	<b>20M2319</b>	10A		192	1222,31	1218,00	-	400	1158	250,8	250,8	-	48		
	<b>216 20M 230</b>	<b>20M2321</b>	10A		216	1375,10	1370,78	-	400	1300	250,8	250,8	-	48		

**HTD® 20M-290**

Caratteristiche Features Merkmal Características	Codice Code symbol Fabriknummer Code symbole Numero de fabrica	Nostro codice Our code Unser kode Notre code Nuestro codigo	Tipo Type Typ Type Tipo	Tipo flangia Flanges type Bordscheiben Typ Type flasques Tipo tapetas	N. denti N. of teeth Zahnezahl N. bre de dents Cantidad de dientes	Dp	De	Df	Dm	Di	F	L	e	d	Peso Weight / Gewicht Poids / Peso Kg	
Ghisa / Cast iron / Grauguss / Fonte / Hierro fundido	con flangia / with flanges mit Flanges / avec flasques con tapetas	<b>52 20M 290</b>	<b>20M2952</b>	6F	F73	52	331,04	326,72	350	280	-	311,2	343	-	38	
	<b>56 20M 290</b>	<b>20M2956</b>	6F	F74	56	356,51	352,19	375	280	-	311,2	343	-	38		
	<b>60 20M 290</b>	<b>20M2960</b>	6F	F75	60	381,97	377,65	405	300	-	311,2	343	-	38		
	<b>64 20M 290</b>	<b>20M2964</b>	6F	F76	64	407,44	403,12	430	300	-	311,2	343	-	38		
	<b>68 20M 290</b>	<b>20M2968</b>	6F	F77	68	432,90	428,58	455	300	-	311,2	343	-	38		
	<b>72 20M 290</b>	<b>20M2972</b>	6F	F78	72	458,37	454,05	480	300	-	311,2	343	-	44		
	<b>80 20M 290</b>	<b>20M2980</b>	6F	F79	80	509,30	504,98	530	300	-	311,2	343	-	44		
	<b>90 20M 290</b>	<b>20M2990</b>	10WF	F80	90	572,96	568,64	595	300	508	311,2	311,2	-	44		
senza flangia / without flanges / ohne Flanschen sans flasques / sin tapetas	<b>112 20M 290</b>	<b>20M2911</b>	10A		112	713,01	708,70	-	350	648	311,2	311,2	-	48		
	<b>144 20M 290</b>	<b>20M2914</b>	10A		144	916,73	912,41	-	350	852	311,2	311,2	-	48		
	<b>168 20M 290</b>	<b>20M2916</b>	10A		168	1069,52	1065,21	-	400	1005	311,2	311,2	-	48		
	<b>192 20M 290</b>	<b>20M2919</b>	10A		192	1222,31	1218,00	-	400	1158	311,2	311,2	-	48		
	<b>216 20M 290</b>	<b>20M2921</b>	10A		216	1375,10	1370,78	-	400	1300	311,2	311,2	-	48		

## HTD® 20M-340

Caratteristiche Features Merkmale Caractéristiques Características	Codice Code symbol Fabriknummer Code symbole Numero de fabrica	Nostro codice Our code Unser kode Notre code Nuestro codigo	Tipo Type Typ Type Tipo	Tipo flangia Flanges type Bordscheiben Typ Type flasques Tipo tapetas	N. denti N. of teeth Zahnezahl N. bre de dents Cantidad de dientes	Dp	De	Df	Dm	Di	F	L	e	d	Peso Weight / Gewicht Poids / Peso Kg
Ghisa / Cast iron / Grauguss / Fonte / Hierro fundido  con flangia / with flanges mit Flanges / avec flasques con tapetas	<b>52 20M 340</b>	<b>20M3452</b>	6F	F73	52	331,04	326,72	350	280	-	362	394	-	38	
	<b>56 20M 340</b>	<b>20M3456</b>	6F	F74	56	356,51	352,19	375	280	-	362	394	-	38	
	<b>60 20M 340</b>	<b>20M3460</b>	6F	F75	60	381,97	377,65	405	300	-	362	394	-	38	
	<b>64 20M 340</b>	<b>20M3464</b>	6F	F76	64	407,44	403,12	430	300	-	362	394	-	44	
	<b>68 20M 340</b>	<b>20M3468</b>	6F	F77	68	432,90	428,58	455	300	-	362	394	-	44	
	<b>72 20M 340</b>	<b>20M3472</b>	6F	F78	72	458,37	454,05	480	300	-	362	394	-	44	
	<b>80 20M 340</b>	<b>20M3480</b>	6F	F79	80	509,30	504,98	530	300	-	362	394	-	44	
	<b>90 20M 340</b>	<b>20M3490</b>	10WF	F80	90	572,96	568,64	595	300	508	362	394	-	48	
Ghisa / Cast iron / Grauguss / Fonte / Hierro fundido  senza flangia / without flanges / ohne Flanschen sans flasques / sin tapetas	<b>112 20M 340</b>	<b>20M3411</b>	10A		112	713,01	708,70	-	350	648	362	362	-	48	
	<b>144 20M 340</b>	<b>20M3414</b>	10A		144	916,73	912,41	-	350	852	362	362	-	48	
	<b>168 20M 340</b>	<b>20M3416</b>	10A		168	1069,52	1065,21	-	400	1005	362	362	-	48	
	<b>192 20M 340</b>	<b>20M3419</b>	10A		192	1222,31	1218,00	-	400	1158	362	362	-	48	
	<b>216 20M 340</b>	<b>20M3421</b>	10A		216	1375,10	1370,78	-	400	1300	362	362	-	48	

**Barre dentate HTD® / HTD® Standard toothed bars**  
**HTD® Standard Zahnriemenstangen / Barreaux dentés standard HTD®**  
**Barras dentadas de serie HTD®**



**Materiale:** alluminio 6082 T6 UNI 9006/4 adatto al trattamento anodico  
**Material:** aluminium 6082 T6 UNI 9006/4 suitable for anodic treatment  
**Werkstoff:** aluminium 6082 T6 UNI 9006/4 geeignet für anodischen oxydation  
**Matière:** aluminium 6082 T6 UNI 9006/4 apte au traitement anodique  
**Material:** aluminio 6082 T6 UNI 9006/4 apto para la oxidacion anodica

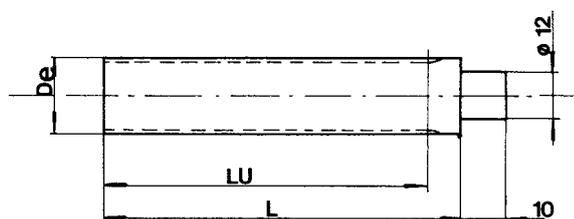
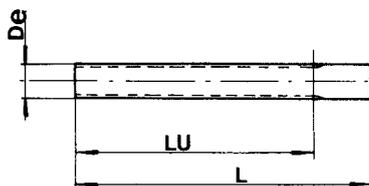

**HTD® 3M**

Codice Code symbol Fabriknummer Code symbole Numero de fabrica	Nostro codice Our code Unser kode Notre code Nuestro codigo	N. denti N. of teeth Zahnezahl N. bre de dents Cantidad de dientes	Dp	De	Lu	L
9 3M	B03M009	9	8,59	7,83	75	100
10 3M	B03M010	10	9,55	8,79	75	100
11 3M	B03M011	11	10,50	9,74	75	100
12 3M	B03M012	12	11,46	10,70	100	125
13 3M	B03M013	13	12,41	11,65	100	125
14 3M	B03M014	14	13,37	12,61	100	125
15 3M	B03M015	15	14,32	13,56	100	125
16 3M	B03M016	16	15,28	14,52	125	155
17 3M	B03M017	17	16,23	15,47	125	155
18 3M	B03M018	18	17,19	16,43	125	155
19 3M	B03M019	19	18,14	17,38	125	155
20 3M	B03M020	20	19,10	18,34	150	165
21 3M	B03M021	21	20,05	19,25	150	165
22 3M	B03M022	22	21,01	20,25	150	165
23 3M	B03M023	23	21,96	21,20	150	165
24 3M	B03M024	24	22,92	22,16	150	165
25 3M	B03M025	25	23,87	23,11	150	165
26 3M	B03M026	26	24,83	24,07	150	165
27 3M	B03M027	27	25,78	25,02	150	165
28 3M	B03M028	28	26,74	25,98	150	165
29 3M	B03M029	29	27,69	26,93	150	165
30 3M	B03M030	30	28,65	27,89	175	183
31 3M	B03M031	31	29,60	28,84	175	183
32 3M	B03M032	32	30,56	29,80	175	183
33 3M	B03M033	33	31,54	30,75	175	183
34 3M	B03M034	34	32,47	31,71	175	183
35 3M	B03M035	35	33,42	32,66	175	183
36 3M	B03M036	36	34,38	33,62	200	200
37 3M	B03M037	37	35,33	34,57	200	200
38 3M	B03M038	38	36,29	35,53	200	200
39 3M	B03M039	39	37,24	36,48	200	200
40 3M	B03M040	40	38,20	37,44	200	200
42 3M	B03M042	42	40,11	39,34	200	200
44 3M	B03M044	44	42,02	41,26	200	200
45 3M	B03M045	45	42,97	42,21	200	200
48 3M	B03M048	48	45,84	45,08	200	200
50 3M	B03M050	50	47,75	46,99	200	200
52 3M	B03M052	52	49,66	48,90	200	200
54 3M	B03M054	54	51,57	50,81	200	200
56 3M	B03M056	56	53,48	52,72	200	200
60 3M	B03M060	60	57,30	56,54	200	200
62 3M	B03M062	62	59,21	58,45	200	200
64 3M	B03M064	64	61,12	60,36	200	200
66 3M	B03M066	66	63,03	62,27	200	200
68 3M	B03M068	68	64,94	64,18	200	200
70 3M	B03M070	70	66,85	66,09	200	200
72 3M	B03M072	72	68,75	67,99	200	200

**HTD® 5M**

Codice Code symbol Fabriknummer Code symbole Numero de fabrica	Nostro codice Our code Unser kode Notre code Nuestro codigo	N. denti N. of teeth Zahnezahl N. bre de dents Cantidad de dientes	Dp	De	Lu	L
12 - 5M	B05M012	12	19,10	17,96	150	165
13 - 5M	B05M013	13	20,69	19,55	150	165
14 - 5M	B05M014	14	22,28	21,14	175	183
15 - 5M	B05M015	15	23,87	22,73	175	183
16 - 5M	B05M016	16	25,46	24,32	175	183
17 - 5M	B05M017	17	27,06	25,92	175	183
18 - 5M	B05M018	18	28,65	27,51	200	200
19 - 5M	B05M019	19	30,24	29,10	200	200
20 - 5M	B05M020	20	31,83	30,69	200	200
21 - 5M	B05M021	21	33,42	32,28	200	200
22 - 5M	B05M022	22	35,01	33,87	200	200
23 - 5M	B05M023	23	36,61	35,47	200	200
24 - 5M	B05M024	24	38,20	37,06	200	200
25 - 5M	B05M025	25	39,79	38,65	200	200
26 - 5M	B05M026	26	41,38	40,24	200	200
27 - 5M	B05M027	27	42,97	41,83	200	200
28 - 5M	B05M028	28	44,56	43,42	200	200
29 - 5M	B05M029	29	46,15	45,01	200	200
30 - 5M	B05M030	30	47,75	46,60	200	200
31 - 5M	B05M031	31	49,34	48,20	200	200
32 - 5M	B05M032	32	50,93	49,79	200	200
33 - 5M	B05M033	33	52,52	51,38	200	200
34 - 5M	B05M034	34	54,11	52,97	200	200
35 - 5M	B05M035	35	55,70	54,56	200	200
36 - 5M	B05M036	36	57,30	56,16	200	200
38 - 5M	B05M038	38	60,48	59,34	200	200
40 - 5M	B05M040	40	63,66	62,52	200	200
42 - 5M	B05M042	42	66,85	65,71	200	200
44 - 5M	B05M044	44	70,03	68,89	200	200
45 - 5M	B05M045	45	71,62	70,48	200	200
46 - 5M	B05M046	46	73,21	72,07	200	200
48 - 5M	B05M048	48	76,39	75,25	200	200
50 - 5M	B05M050	50	79,58	78,43	200	200
54 - 5M	B05M054	54	85,94	84,80	200	200
60 - 5M	B05M060	60	95,49	94,35	200	200
62 - 5M	B05M062	62	98,68	97,54	200	200
72 - 5M	B05M072	72	114,59	113,45	200	200

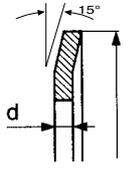
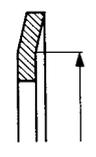
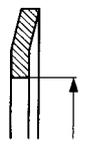

N. denti N. of teeth Zahnezahl N. bre de dents Cantidad de dientes	Flangia / Flanges / Bordscheiben / Flasques / Tapetas				
	d = 0,5 mm	d = 1 mm	d = 1,5 mm	d = 2,5 mm	d = 4 mm
	HTD® 3M	HTD® 5M	HTD® 8M	HTD® 14M	HTD® 20M
10	F 01	-	-	-	-
11	-	-	-	-	-
12	F 02	F 07	-	-	-
13	-	-	-	-	-
14	F 03	F 08	-	-	-
15	F 04	F 09	-	-	-
16	F 05	F 09	-	-	-
17	-	-	-	-	-
18	F 06	F 10	-	-	-
19	-	-	-	-	-
20	F 07	F 12	-	-	-
21	F 08	F 14	-	-	-
22	F 08	F 14	F 22	-	-
23	-	-	-	-	-
24	F 08	F 15	F 25	-	-
25	-	-	-	-	-
26	F 09	F 17	F 26	-	-
27	-	-	-	-	-
28	F 10	F 18	F 27	F 40	-
29	-	-	-	F 43	-
30	F 10	F 19	F 29	F 43	-
31	-	-	-	-	-
32	F 12	F 20	F 30	F 49	-
33	-	-	-	-	-
34	-	F 21	F 31	F 51	F 64
35	-	-	-	-	-
36	F 14	F 22	F 33	F 52	F 65
37	-	-	-	-	-
38	-	F 25	F 34	F 81	F 67
39	-	-	-	-	-
40	F 15	F 26	F 35	F 56	F 68
41	-	-	-	-	-
42	-	-	-	-	-
43	-	-	-	-	-
44	F 18	F 27	F 38	F 61	F 71
45	-	-	-	-	-
46	-	-	-	-	-
47	-	-	-	-	-
48	-	F 29	F 40	F 62	F 72
49	-	-	-	-	-
50	-	-	-	-	-
51	-	-	-	-	-
52	-	-	-	-	F 73
53	-	-	-	-	-
54	-	-	-	-	-
55	-	-	-	-	-
56	-	F 32	F 48	F 66	F 74
57	-	-	-	-	-
58	-	-	-	-	-
59	-	-	-	-	-
60	-	-	-	-	F 75
61	-	-	-	-	-
62	-	-	-	-	-
63	-	-	-	-	-
64	-	F 35	F 52	F 70	F 76
65	-	-	-	-	-
66	-	-	-	-	-
67	-	-	-	-	-
68	-	-	-	-	F 77
69	-	-	-	-	-
70	-	-	-	-	-
71	-	-	-	-	-
72	-	-	F 57	-	F 78
80	-	-	-	-	F 79
90	-	-	-	-	F 80

Tipo flangia Flanges type Bordcheiben Typ Type flasques Tipo tapetas			
F 01	13,0	10,0	6,0
F 02	15,0	12,0	8,0
F 03	16,0	13,0	9,5
F 04	17,5	14,5	11,6
F 05	18,0	15,0	11,5
F 06	20,0	16,5	12,2
F 07	23,0	18,0	12,5
F 08	25,0	21,5	15,0
F 09	28,0	24,0	17,8
F 10	32,0	27,5	23,0
F 11	35,0	30,5	23,0
F 12	36,0	31,0	25,0
F 13	37,0	33,0	25,0
F 14	38,0	34,0	26,5
F 15	42,0	38,0	30,5
F 16	43,0	39,0	31,0
F 17	44,0	40,5	32,5
F 18	48,0	43,5	37,0
F 19	51,0	47,0	40,0
F 20	54,0	50,5	43,0
F 21	57,0	52,0	46,0
F 22	60,0	57,0	47,0
F 23	61,0	56,5	49,0
F 24	64,0	57,0	47,0
F 25	66,0	63,0	52,0
F 26	70,0	66,5	53,0
F 27	75,0	68,5	60,0
F 28	79,0	72,5	60,0
F 29	83,0	78,0	68,0
F 30	87,0	82,5	72,0
F 31	91,0	85,5	76,0
F 32	93,0	89,0	80,0
F 33	97,0	93,8	83,0
F 34	102,0	97,0	82,5
F 35	106,0	101,0	90,0
F 36	112,0	105,5	91,0
F 37	115,0	109,0	94,0
F 38	120,0	112,5	99,5
F 39	123,0	117,5	107,0
F 40	128,0	124,0	107,0
F 41	131,0	125,5	115,0
F 42	135,0	128,5	115,0
F 43	138,0	132,0	121,0
F 44	140,0	125,0	107,0
F 45	142,0	137,0	120,0
F 46	146,0	133,0	107,0
F 47	148,0	143,0	132,0
F 48	150,0	145,0	130,0
F 49	154,0	142,0	122,0
F 50	158,0	153,0	138,5
F 51	160,0	148,0	120,0
F 52	168,0	161,0	148,0
F 53	175,0	170,0	157,0
F 54	180,0	174,0	154,0
F 55	184,0	177,0	162,0
F 56	188,0	176,0	150,0
F 57	192,0	187,0	173,0
F 58	198,0	180,0	150,0
F 59	200,0	193,0	180,0
F 60	205,0	189,0	160,0
F 61	212,0	200,0	162,0
F 62	226,0	214,0	190,0
F 63	230,0	222,0	200,0
F 64	240,0	224,0	192,0
F 65	250,0	228,0	200,0
F 66	256,0	240,0	220,0
F 67	265,0	240,0	213,0
F 68	275,0	253,0	225,0
F 69	286,0	277,0	242,0
F 70	296,0	287,0	260,0
F 71	300,0	280,0	252,0
F 72	325,0	305,0	278,0
F 73	350,0	330,0	302,0
F 74	375,0	355,0	328,0
F 75	405,0	380,0	354,0
F 76	430,0	406,0	380,0
F 77	455,0	432,0	405,0
F 78	480,0	457,0	430,0
F 79	530,0	508,0	481,0
F 80	595,0	572,0	544,0
F 81	184,0	168,0	135,0

**Pulegge dentate HTD® per bussola conica**  
**HTD® Timing belt pulleys for taper bushes**  
**HTD® Zahnriemenscheiben für Spannbüchsen**  
**Poulies dentées HTD® à moyeu amovible**  
**Poleas dentadas HTD® para casquillos**  
**cónicos (taper)**

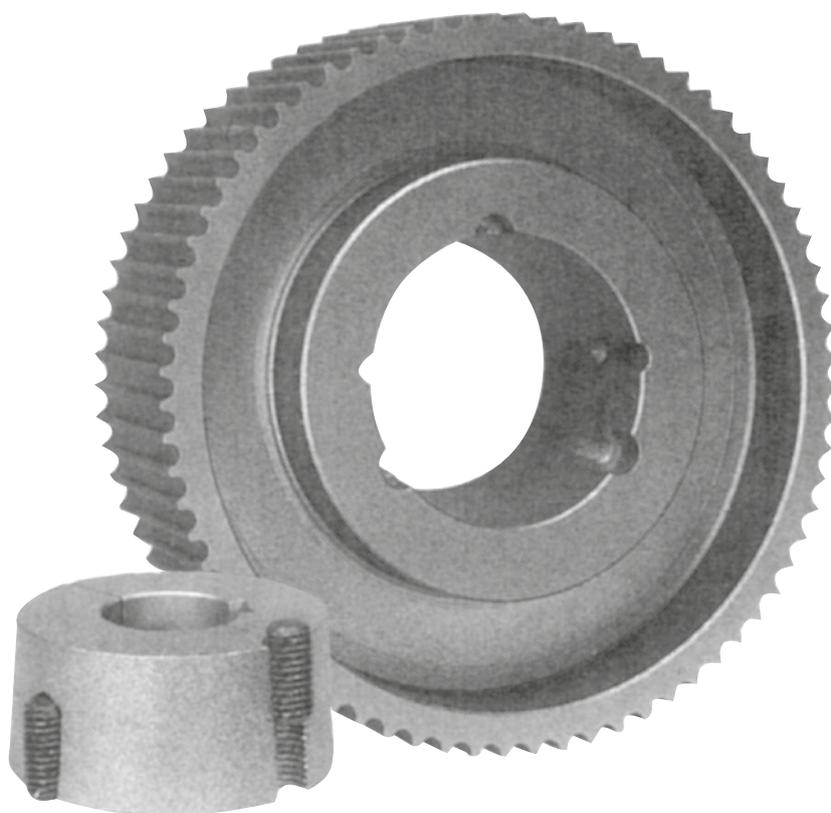

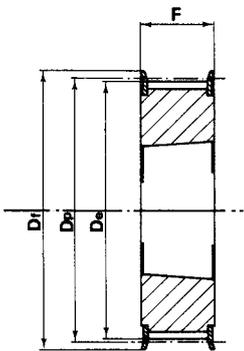

**Tipo / Type**  
**3F**

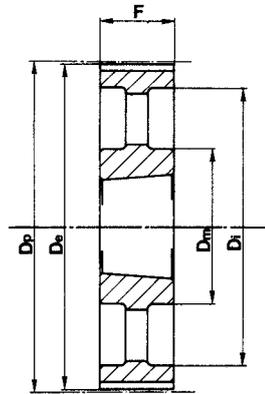

**Tipo / Type**  
**3A**

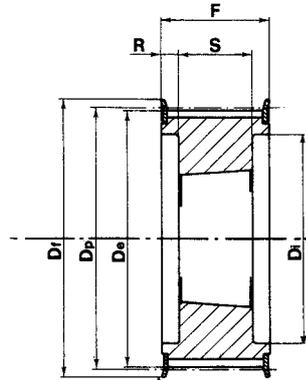

**Tipo / Type**  
**4F**

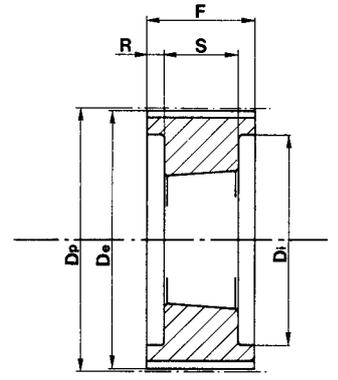

**Tipo / Type**  
**4**

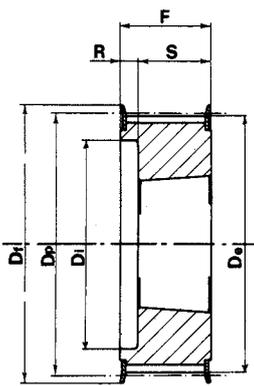

**Tipo / Type**  
**5F**

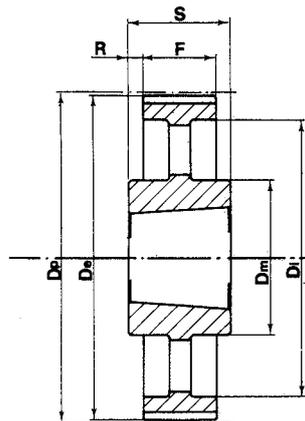

**Tipo / Type**  
**7A**

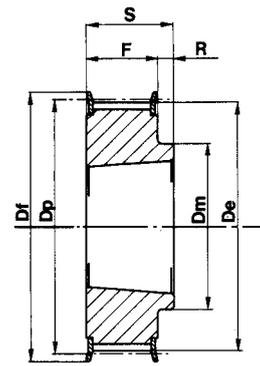

**Tipo / Type**  
**8F**

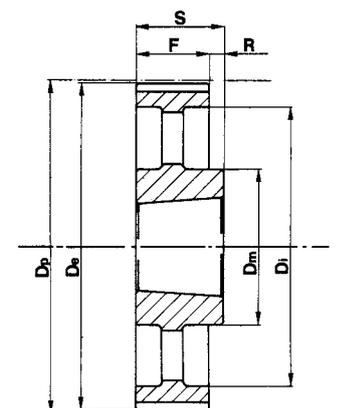

**Tipo / Type**  
**8A**

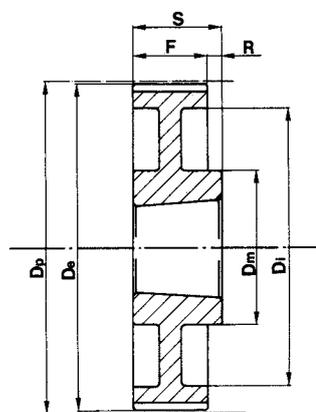

**Tipo / Type**  
**8W**

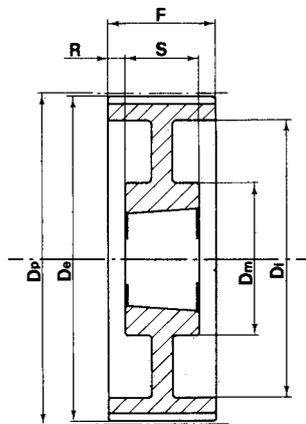

**Tipo / Type**  
**9W**

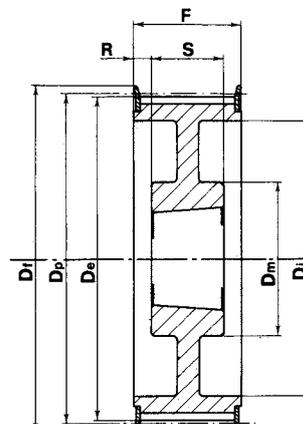

**Tipo / Type**  
**9WF**

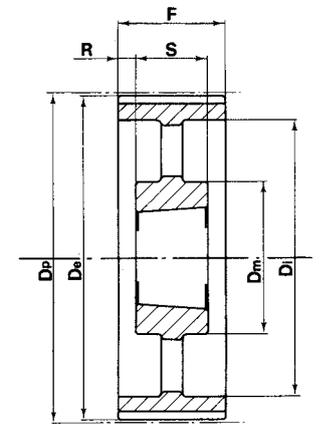

**Tipo / Type**  
**9A**

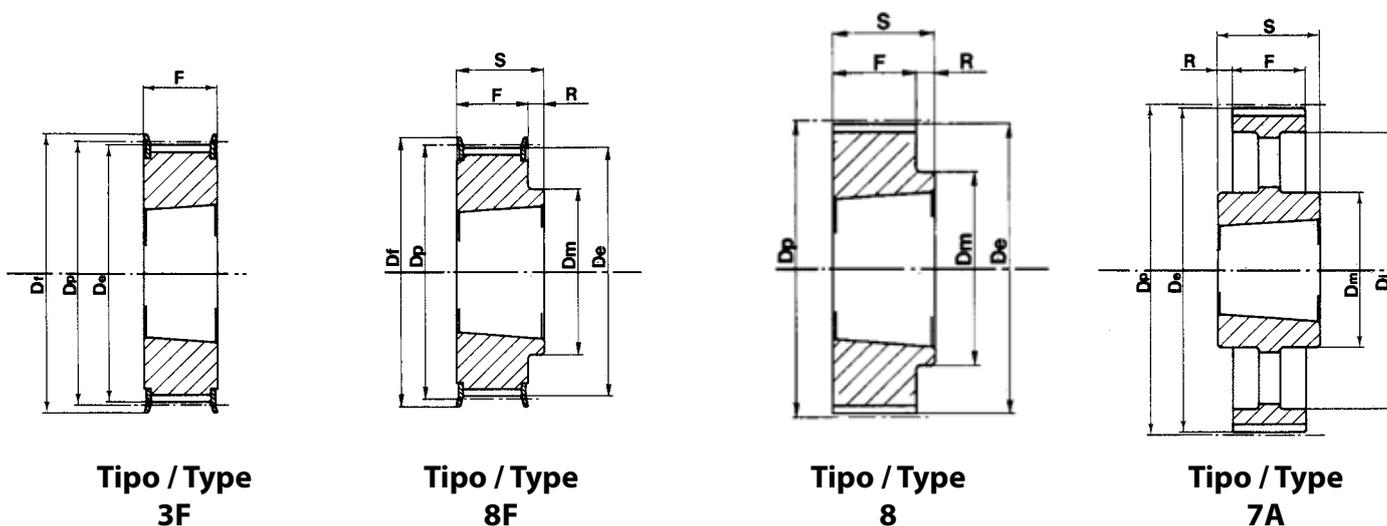

## HTD® 5M-15

Caratteristiche Features Merkmale Características	Codice Code symbol Fabriknummer Code symbole Numero de fabrica	Nostro codice Our code Unser kode Notre code Nuestro codigo	Tipo Type Typ Type Tipo	Tipo flangia Flanges type Bordscheiben Typ Type flasques Tipo tapetas	Bussola Bush Buchse Moyeu Casquillo	Foro max. Max. Bore Max. Bohrung Alesage max. Agujero max.	Dp	De	Df	Dm	Di	F	S	R	Peso Weight / Gewicht Poids / Peso Kg
con flangia / with flanges mit Flanges / avec flasques / con tapetas	<b>34 5M 15</b>	<b>0515034</b>	3F	F21	1008	25	54,11	52,97	57	-	-	22	22	-	
	<b>36 5M 15</b>	<b>0515036</b>	3F	F22	1108	25	57,30	56,15	60	-	-	22	22	-	
	<b>38 5M 15</b>	<b>0515038</b>	3F	F25	1108	25	60,48	59,34	66	-	-	22	22	-	
	<b>40 5M 15</b>	<b>0515040</b>	3F	F26	1108	25	63,66	62,52	70	-	-	22	22	-	
	<b>44 5M 15</b>	<b>0515044</b>	3F	F27	1108	25	70,03	68,89	75	-	-	22	22	-	
	<b>48 5M 15</b>	<b>0515048</b>	8F	F29	1210	32	76,39	75,25	83	59	-	22	25	3	
	<b>56 5M 15</b>	<b>0515056</b>	8F	F32	1210	32	89,13	87,98	93	70	-	22	25	3	
	<b>64 5M 15</b>	<b>0515064</b>	8F	F35	1210	32	101,86	100,72	106	80	-	22	25	3	
senza flangia / without flanges ohne Flanschen / sans flasques sin tapetas	<b>72 5M 15</b>	<b>0515072</b>	8	-	1610	42	114,59	113,45	-	92	-	22	25	3	
	<b>80 5M 15</b>	<b>0515080</b>	8	-	1610	42	127,32	126,18	-	92	-	22	25	3	
	<b>90 5M 15</b>	<b>0515090</b>	8	-	1610	42	143,24	142,10	-	92	-	22	25	3	
	<b>112 5M 15</b>	<b>0515112</b>	8	-	2012	50	178,25	177,11	-	110	-	20	32	12	
	<b>136 5M 15</b>	<b>0515136</b>	7A	-	2012	50	216,45	215,31	-	110	199	20	32	6	

### HTD® 8M-20

Caratteristiche Features Merkmale Características	Codice Code symbol Fabriknummer Code symbole Numero de fabrica	Nostro codice Our code Unser kode Notre code Nuestro codigoo	Tipo Type Typ Type Tipo	Tipo flangia Flanges type Bordscheiben Typ Type flasques Tipo tapetas	Bussola Bush Buchse Moyeu Casquillo	Foro max. Max. Bore Max. Bohrung Alesage max. Agujero max.	Dp	De	Df	Dm	Di	F	S	R	Peso Weight / Gewicht Poids / Peso Kg
Acciaio / Steel / Stahl Acier / Acero  con flangia / with flanges mit Flanges / avec flasques / con tapetas	<b>22-8M-20</b>	<b>0820022</b>	5F	F22	1008	25	56,02	54,65	60	-	37	28	22	6	0,25
	<b>24 8M 20</b>	<b>0820024</b>	5F	F25	1108	25	61,12	59,75	66	-	44	28	22	6	0,30
	<b>26 8M 20</b>	<b>0820026</b>	5F	F26	1108	25	66,21	64,84	70	-	45	28	22	6	0,36
	<b>28 8M 20</b>	<b>0820028</b>	5F	F27	1108	25	71,30	70,08	75	-	50	28	22	6	0,44
	<b>30 8M 20</b>	<b>0820030</b>	5F	F29	1108	25	76,39	75,13	83	-	58	28	22	6	0,53
	<b>32 8M 20</b>	<b>0820032</b>	5F	F30	1610	42	81,49	80,16	87	-	63	28	25	3	0,42
	<b>34 8M 20</b>	<b>0820034</b>	5F	F31	1610	42	86,58	85,22	91	-	64	28	25	3	0,55
	<b>36 8M 20</b>	<b>0820036</b>	5F	F33	1610	42	91,67	90,30	97	-	68	28	25	3	0,68
	<b>38 8M 20</b>	<b>0820038</b>	5F	F34	1610	42	96,77	95,39	102	-	72	28	25	3	0,80
	<b>40 8M 20</b>	<b>0820040</b>	5F	F35	1610	42	101,86	100,49	106	-	76	28	25	3	1,00
	<b>44 8M 20</b>	<b>0820044</b>	8F	F38	2012	50	112,05	110,67	120	93	-	28	32	4	1,20
	<b>48 8M 20</b>	<b>0820048</b>	8F	F40	2012	50	122,23	120,86	128	96	-	28	32	4	1,60
	<b>56 8M 20</b>	<b>0820056</b>	8F	F48	2012	50	142,60	141,23	150	110	-	28	32	4	2,40
	<b>64 8M 20</b>	<b>0820064</b>	9WF	F52	2012	50	162,97	161,60	168	110	137	28	32	4	2,70
<b>72 8M 20</b>	<b>0820072</b>	9WF	F57	2012	50	183,35	181,97	192	110	158	28	32	4	3,30	
Ghisa / Cast iron Grauguss / Fonte Hierro fundido  senza flangia / without flanges ohne Flanschen / sans flasques sin tapetas	<b>80 8M 20</b>	<b>0820080</b>	8W		2012	50	203,72	202,35	-	110	180	28	32	4	3,50
	<b>90 8M 20</b>	<b>0820090</b>	8A		2012	50	229,18	227,81	-	110	204	28	32	4	3,65
	<b>144 8M 20</b>	<b>0820144</b>	8A		2517	60	366,69	365,32	-	125	336	28	45	17	4,80

### HTD® 8M-30

Caratteristiche Features Merkmale Características	Codice Code symbol Fabriknummer Code symbole Numero de fabrica	Nostro codice Our code Unser kode Notre code Nuestro codigoo	Tipo Type Typ Type Tipo	Tipo flangia Flanges type Bordscheiben Typ Type flasques Tipo tapetas	Bussola Bush Buchse Moyeu Casquillo	Foro max. Max. Bore Max. Bohrung Alesage max. Agujero max.	Dp	De	Df	Dm	Di	F	S	R	Peso Weight / Gewicht Poids / Peso Kg
Acciaio / Steel / Stahl Acier / Acero  con flangia / with flanges mit Flanges / avec flasques / con tapetas	<b>22 8M 30</b>	<b>0830022</b>	5F	F22	1008	25	56,02	54,65	60	-	37	38	22	16	0,31
	<b>24 8M 30</b>	<b>0830024</b>	5F	F25	1108	25	61,12	59,75	66	-	44	38	22	16	0,38
	<b>26 8M 30</b>	<b>0830026</b>	5F	F26	1108	25	66,21	64,84	70	-	44	38	22	16	0,45
	<b>28 8M 30</b>	<b>0830028</b>	5F	F27	1210	32	71,30	70,08	75	-	50	38	25	13	0,50
	<b>30 8M 30</b>	<b>0830030</b>	3F	F29	1615	42	76,39	75,13	83	-	-	38	38	-	0,55
	<b>32 8M 30</b>	<b>0830032</b>	3F	F30	1615	42	81,49	80,16	87	-	-	38	38	-	0,59
	<b>34 8M 30</b>	<b>0830034</b>	3F	F31	1615	42	86,58	85,22	91	-	-	38	38	-	0,77
	<b>36 8M 30</b>	<b>0830036</b>	3F	F33	1615	42	91,67	90,30	97	-	-	38	38	-	0,96
	<b>38 8M 30</b>	<b>0830038</b>	3F	F34	1615	42	96,77	95,39	102	-	-	38	38	-	1,15
	<b>40 8M 30</b>	<b>0830040</b>	3F	F35	1615	42	101,86	100,49	106	-	-	38	38	-	1,34
	<b>44 8M 30</b>	<b>0830044</b>	4F	F38	2012	50	112,05	110,67	120	-	86	38	32	3	1,33
	<b>48 8M 30</b>	<b>0830048</b>	4F	F40	2012	50	122,23	120,86	128	-	90	38	32	3	1,78
	<b>56 8M 30</b>	<b>0830056</b>	4F	F48	2012	50	142,60	141,23	150	-	110	38	32	3	3,76
	<b>64 8M 30</b>	<b>0830064</b>	8F	F57	2517	60	162,97	161,60	192	125	-	38	45	7	4,20
<b>72 8M 30</b>	<b>0830072</b>	9WF		2517	60	183,35	181,97	-	125	158	38	45	7	4,30	
Ghisa / Cast iron Grauguss / Fonte Hierro fundido  senza flangia / without flanges ohne Flanschen / sans flasques sin tapetas	<b>80 8M 30</b>	<b>0830080</b>	8W		2517	60	203,72	202,35	-	125	180	38	45	7	4,60
	<b>90 8M 30</b>	<b>0830090</b>	8A		2517	60	229,18	227,81	-	125	204	38	45	7	5,00
	<b>112 8M 30</b>	<b>0830112</b>	8A		2517	60	285,21	283,83	-	125	254	38	45	7	6,20
	<b>144 8M 30</b>	<b>0830144</b>	8A		2517	60	366,69	365,32	-	125	336	38	45	7	9,00



**Pulegge dentate HTD® per bussola conica / HTD® Timing belt pulleys for taper bushes**  
**HTD® Zahnriemenscheiben für Spannbüchsen / Poulies dentées HTD® à moyeu amovible**  
**Poleas dentadas HTD® para casquillos cónicos**



**HTD® 8M-50**

Caratteristiche Features Merkmale Características	Codice Code symbol Fabriknummer Code symbole Numero de fabrica	Nostro codice Our code Unser kode Notre code Nuestro codigo	Tipo Type Typ Type Tipo	Tipo flangia Flanges type Bordscheiben Typ Type flasques Tipo tapetas	Bussola Bush Buchse Moyeu Casquillo	Foro max. Max. Bore Max. Bohrung Alesage max. Agujero max.	Dp	De	Df	Dm	Di	F	S	R	Peso Weight / Gewicht Poids / Peso Kg
Acciaio / Steel / Stahl Acier / Acero	<b>28 8M 50</b>	<b>0850028</b>	4F	F27	1210	32	71,30	70,08	75	-	50	60	25	17,5	0,60
	<b>30 8M 50</b>	<b>0850030</b>	5F	F29	1615	42	76,39	75,13	83	-	58	60	38	22,0	0,65
	<b>32 8M 50</b>	<b>0850032</b>	5F	F30	1615	42	81,49	80,16	87	-	62	60	38	22,0	0,82
	<b>34 8M 50</b>	<b>0850034</b>	5F	F31	1615	42	86,58	85,22	91	-	65	60	38	22,0	1,06
	<b>36 8M 50</b>	<b>0850036</b>	5F	F33	1615	42	91,67	90,30	97	-	68	60	38	22,0	1,30
	<b>38 8M 50</b>	<b>0850038</b>	5F	F34	1615	42	96,77	95,39	102	-	72	60	38	22,0	1,60
	<b>40 8M 50</b>	<b>0850040</b>	4F	F35	2012	50	101,86	100,49	106	-	82	60	32	14,0	1,71
	<b>44 8M 50</b>	<b>0850044</b>	4F	F38	2012	50	112,05	110,67	120	-	91	60	32	14,0	1,78
	<b>48 8M 50</b>	<b>0850048</b>	4F	F40	2012	50	122,23	120,86	128	-	95	60	32	14,0	2,30
	<b>56 8M 50</b>	<b>0850056</b>	4F	F48	2517	60	142,60	141,23	150	-	116	60	45	7,5	3,40
	<b>64 8M 50</b>	<b>0850064</b>	4F	F52	2517	60	162,97	161,60	168	-	137	60	45	7,5	5,00
<b>72 8M 50</b>	<b>0850072</b>	9WF	F57	2517	60	183,35	181,97	192	125	158	60	45	7,5	6,70	
Ghisa / Cast iron Grauguss / Fonte Hierro fundido	<b>80 8M 50</b>	<b>0850080</b>	4		3020	75	203,72	202,35	-	-	180	60	51	4,5	8,80
	<b>90 8M 50</b>	<b>0850090</b>	9W		3020	75	229,18	227,81	-	170	204	60	51	4,5	10,00
	<b>112 8M 50</b>	<b>0850112</b>	9W		3020	75	285,21	283,83	-	170	260	60	51	4,5	12,00
	<b>144 8M 50</b>	<b>0850144</b>	9A		3020	75	366,69	365,32	-	170	341	60	51	4,5	15,20
	<b>168 8M 50</b>	<b>0850168</b>	7A		3525	90	427,81	426,44	-	198	402	60	65	2,5	17,50
	<b>192 8M 50</b>	<b>0850192</b>	7A		3525	90	488,92	487,55	-	198	460	60	65	2,5	24,00

**HTD® 8M-85**

Caratteristiche Features Merkmale Características	Codice Code symbol Fabriknummer Code symbole Numero de fabrica	Nostro codice Our code Unser kode Notre code Nuestro codigo	Tipo Type Typ Type Tipo	Tipo flangia Flanges type Bordscheiben Typ Type flasques Tipo tapetas	Bussola Bush Buchse Moyeu Casquillo	Foro max. Max. Bore Max. Bohrung Alesage max. Agujero max.	Dp	De	Df	Dm	Di	F	S	R	Peso Weight / Gewicht Poids / Peso Kg
Acciaio / Steel / Stahl Acier / Acero	<b>34 8M 85</b>	<b>0885034</b>	4F	F31	1615	42	86,58	85,22	91	-	65	95	38	28,5	1,43
	<b>36 8M 85</b>	<b>0885036</b>	4F	F33	1615	42	91,67	90,30	97	-	68	95	38	28,5	1,87
	<b>38 8M 85</b>	<b>0885038</b>	4F	F34	1615	42	96,77	95,39	102	-	72	95	38	28,5	2,20
	<b>40 8M 85</b>	<b>0885040</b>	4F	F35	2012	50	101,86	100,49	106	-	82	95	32	31,5	1,80
	<b>44 8M 85</b>	<b>0885044</b>	4F	F38	2012	50	112,05	110,67	120	-	91	95	32	31,5	2,30
	<b>48 8M 85</b>	<b>0885048</b>	4F	F40	2517	60	122,23	120,86	128	-	100	95	45	25,0	2,66
	<b>56 8M 85</b>	<b>0885056</b>	4F	F48	2517	60	142,60	141,23	150	-	117	95	45	25,0	4,45
	<b>64 8M 85</b>	<b>0885064</b>	4F	F52	2517	60	162,97	161,60	168	-	137	95	45	25,0	6,20
<b>72 8M 85</b>	<b>0885072</b>	4F	F57	3020	75	183,35	181,97	192	-	158	95	51	22,0	8,00	
Ghisa / Cast iron Grauguss / Fonte Hierro fundido	<b>80 8M 85</b>	<b>0885080</b>	4		3020	75	203,72	202,35	-	-	180	95	51	22,0	10,00
	<b>90 8M 85</b>	<b>0885090</b>	9W		3020	75	229,18	227,81	-	170	204	95	51	22,0	10,80
	<b>112 8M 85</b>	<b>0885112</b>	9W		3020	75	285,21	283,83	-	170	260	95	51	22,0	15,00
	<b>144 8M 85</b>	<b>0885144</b>	9A		3525	90	366,69	365,32	-	198	336	95	65	15,0	20,00
	<b>168 8M 85</b>	<b>0885168</b>	9A		3525	90	427,81	426,44	-	198	395	95	65	15,0	22,00
	<b>192 8M 85</b>	<b>0885192</b>	9A		3525	90	488,92	487,55	-	198	455	95	65	15,0	26,00

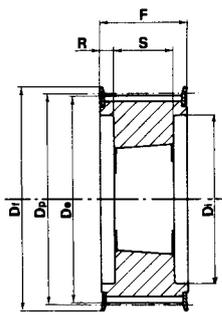

**Tipo / Type**  
**4F**

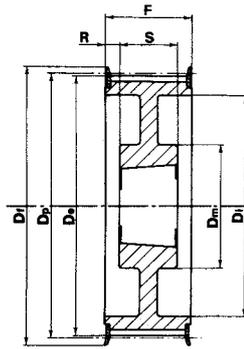

**Tipo / Type**  
**9WF**

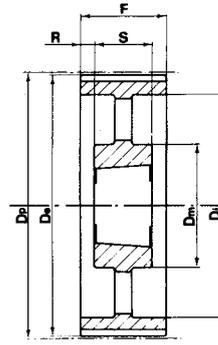

**Tipo / Type**  
**9A**

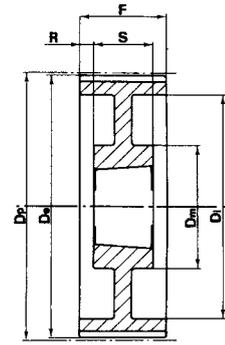

**Tipo / Type**  
**9W**

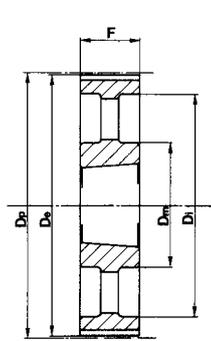

**Tipo / Type**  
**3A**

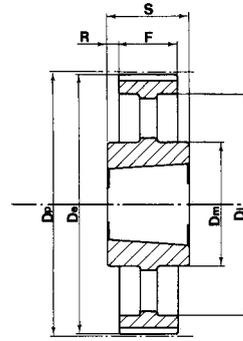

**Tipo / Type**  
**7A**

**HTD® 14M-40**

Caratteristiche Features Merkmale Características Características	Codice Code symbol Fabriknummer Code symbole Numero de fabrica	Nostro codice Our code Unser kode Notre code Nuestro codigo	Tipo Type Typ Type Tipo	Tipo flangia Flanges type Bordscheiben Typ Type flasques Tipo tapetas	Bussola Bush Buchse Moyeu Casquillo	Foro max. Max. Bore Max. Bohrung Alesage max. Agujero max.	Dp	De	Df	Dm	Di	F	S	R	Peso Weight / Gewicht Poids / Peso Kg
Acciaio / Steel / Stahl Acier / Acero	<b>28 14M 40</b>	<b>1440028</b>	4F	F40	2012	50	124,78	122,12	128	-	94	54	32	11,0	2,07
	<b>29 14M 40</b>	<b>1440029</b>	4F	F43	2012	50	129,23	126,57	138	-	98	54	32	11,0	2,38
	<b>30 14M 40</b>	<b>1440030</b>	4F	F43	2012	50	133,69	130,99	138	-	98	54	32	11,0	2,65
	<b>32 14M 40</b>	<b>1440032</b>	4F	F49	2012	50	142,60	139,88	154	-	108	54	32	11,0	3,40
	<b>34 14M 40</b>	<b>1440034</b>	4F	F51	2517	60	151,52	148,79	160	-	110	54	45	4,5	3,87
	<b>36 14M 40</b>	<b>1440036</b>	4F	F52	2517	60	160,43	157,68	168	-	120	54	45	4,5	4,80
	<b>38 14M 40</b>	<b>1440038</b>	4F	F81	2517	60	169,34	166,60	184	-	130	54	45	4,5	5,40
	<b>40 14M 40</b>	<b>1440040</b>	4F	F56	2517	60	178,25	175,49	188	-	138	54	45	4,5	6,00
	<b>44 14M 40</b>	<b>1440044</b>	4F	F61	3020	75	196,08	193,28	212	-	155	54	51	1,5	7,80
	<b>48 14M 40</b>	<b>1440048</b>	4F	F62	3020	75	213,90	211,11	226	-	170	54	51	1,5	9,40
Ghisa / Cast iron Grauguss / Fonte Hierro fundido	<b>56 14M 40</b>	<b>1440056</b>	9WF	F66	3020	75	249,55	246,76	256	170	208	54	51	1,5	10,80
	<b>64 14M 40</b>	<b>1440064</b>	9WF	F70	3020	75	285,21	282,41	296	170	240	54	51	1,5	13,40
	<b>72 14M 40</b>	<b>1440072</b>	9W		3020	75	320,86	318,06	-	170	280	54	51	1,5	15,20
	<b>80 14M 40</b>	<b>1440080</b>	9A		3020	75	356,51	353,71	-	170	315	54	51	1,5	16,00
	<b>90 14M 40</b>	<b>1440090</b>	9A		3020	75	401,07	398,28	-	170	360	54	51	1,5	17,80
	<b>112 14M 40</b>	<b>1440112</b>	9A		3020	75	499,11	496,32	-	170	457	54	51	1,5	25,60
	<b>144 14M 40</b>	<b>1440144</b>	9A		3020	75	641,71	638,92	-	170	600	54	51	1,5	32,00
	<b>168 14M 40</b>	<b>1440168</b>	9A		3020	75	748,66	745,87	-	170	706	54	51	1,5	44,00
	<b>192 14M 40</b>	<b>1440192</b>	7A		3535	90	855,62	852,82	-	190	813	54	89	17,5	49,00
	<b>216 14M 40</b>	<b>1440216</b>	7A		3535	90	962,57	959,76	-	190	920	54	89	17,5	55,00

**Pulegge dentate HTD® per bussola conica / HTD® Timing belt pulleys for taper bushes**  
**HTD® Zahnriemenscheiben für Spannbüchsen / Poulies dentées HTD® à moyeu amovible**  
**Poleas dentadas HTD® para casquillos cónicos**



**HTD® 14M-55**

Caratteristiche Features Merkmale Características	Codice Code symbol Fabriknummer Code symbole Numero de fabrica	Nostro codice Our code Unser kode Notre code Nuestro codigo	Tipo Type Typ Type Tipo	Tipo flangia Flanges type Bordscheiben Typ Type flasques Tipo tapetas	Bussola Bush Buchse Moyeu Casquillo	Foro max. Max. Bore Max. Bohrung Alesage max. Agujero max.	Dp	De	Df	Dm	Di	F	S	R	Peso Weight / Gewicht Poids / Peso Kg
Acciaio / Steel / Stahl Acier / Acero	28 14M 55	1455028	4F	F40	2012	50	124,78	122,12	128	-	94	70	32	19,0	2,20
	29 14M 55	1455029	4F	F43	2012	50	129,23	126,57	138	-	100	70	32	19,0	2,74
	30 14M 55	1455030	4F	F43	2517	60	133,69	130,99	138	-	100	70	45	12,5	2,70
	32 14M 55	1455032	4F	F49	2517	60	142,60	139,88	154	-	108	70	45	12,5	3,66
	34 14M 55	1455034	4F	F51	2517	60	151,52	148,79	160	-	110	70	45	12,5	4,55
	36 14M 55	1455036	4F	F52	2517	60	160,43	157,68	168	-	120	70	45	12,5	5,20
	38 14M 55	1455038	4F	F81	2517	60	169,34	166,60	184	-	130	70	45	12,5	6,20
	40 14M 55	1455040	4F	F56	2517	60	178,25	175,49	188	-	138	70	45	12,5	7,00
	44 14M 55	1455044	4F	F61	3020	75	196,08	193,28	212	-	155	70	51	9,5	8,60
	48 14M 55	1455048	4F	F62	3020	75	213,90	211,11	226	-	170	70	51	9,5	10,40
	56 14M 55	1455056	9WF	F66	3020	75	249,55	246,76	256	170	208	70	51	9,5	12,40
Ghisa / Cast iron / Grauguss Fonte / Hierro fundido	64 14M 55	1455064	9WF	F70	3020	75	285,21	282,41	296	170	240	70	51	9,5	14,50
	72 14M 55	1455072	9W		3020	75	320,86	318,06	-	170	280	70	51	9,5	16,20
	80 14M 55	1455080	9A		3020	75	356,51	353,71	-	170	315	70	51	9,5	17,50
	90 14M 55	1455090	9A		3020	75	401,07	398,28	-	170	360	70	51	9,5	20,10
	112 14M 55	1455112	9A		3020	75	499,11	496,32	-	170	457	70	51	9,5	28,40
	144 14M 55	1455144	9A		3020	75	641,71	638,92	-	170	600	70	51	9,5	36,20
	168 14M 55	1455168	9A		3020	75	748,66	745,87	-	170	706	70	51	9,5	49,00
	192 14M 55	1455192	7A		3535	90	855,62	852,82	-	190	813	70	89	9,5	53,00
	216 14M 55	1455216	7A		3535	90	962,57	959,76	-	190	920	70	89	9,5	65,80

**HTD® 14M 85**

Caratteristiche Features Merkmale Características	Codice Code symbol Fabriknummer Code symbole Numero de fabrica	Nostro codice Our code Unser kode Notre code Nuestro codigo	Tipo Type Typ Type Tipo	Tipo flangia Flanges type Bordscheiben Typ Type flasques Tipo tapetas	Bussola Bush Buchse Moyeu Casquillo	Foro max. Max. Bore Max. Bohrung Alesage max. Agujero max.	Dp	De	Df	Dm	Di	F	S	R	Peso Weight / Gewicht Poids / Peso Kg
Acciaio / Steel / Stahl Acier / Acero	28 14M 85	1485028	4F	F40	2517	60	124,78	122,12	128	-	98	102	45	28,5	2,70
	29 14M 85	1485029	4F	F43	2517	60	129,23	126,57	138	-	100	102	45	28,5	3,40
	30 14M 85	1485030	4F	F43	2517	60	133,69	130,99	138	-	100	102	45	28,5	3,75
	32 14M 85	1485032	4F	F49	2517	60	142,60	139,88	154	-	108	102	45	28,5	4,80
	34 14M 85	1485034	4F	F51	2517	60	151,52	148,79	160	-	110	102	45	28,5	6,00
	36 14M 85	1485036	4F	F52	3020	75	160,43	157,68	168	-	120	102	51	25,5	5,80
	38 14M 85	1485038	4F	F81	3020	75	169,34	166,60	184	-	130	102	51	25,5	6,80
	40 14M 85	1485040	4F	F56	3020	75	178,25	175,49	188	-	138	102	51	25,5	8,00
	44 14M 85	1485044	4F	F61	3020	75	196,08	193,28	212	-	153	102	51	25,5	11,80
	48 14M 85	1485048	4F	F62	3020	75	213,90	211,11	226	-	170	102	51	25,5	15,10
	56 14M 85	1485056	4F	F66	3525	90	249,55	246,76	256	-	210	102	65	18,5	19,00
Ghisa / Cast iron / Grauguss Fonte / Hierro fundido	64 14M 85	1485064	9WF	F70	3525	90	285,21	282,41	296	190	240	102	65	18,5	23,00
	72 14M 85	1485072	9W		3525	90	320,86	318,06	-	190	280	102	65	18,5	25,00
	80 14M 85	1485080	9A		3525	90	356,51	353,71	-	190	315	102	65	18,5	26,00
	90 14M 85	1485090	9A		3525	90	401,07	398,28	-	190	360	102	65	18,5	27,80
	112 14M 85	1485112	9A		3525	90	499,11	496,32	-	190	457	102	65	18,5	36,50
	144 14M 85	1485144	9A		3525	90	641,71	638,92	-	190	600	102	65	18,5	48,00
	168 14M 85	1485168	9A		3525	90	748,66	745,87	-	190	706	102	65	18,5	60,00
	192 14M 85	1485192	3A		4040	100	855,62	852,82	-	190	813	102	102	-	86,00
	216 14M 85	1485216	3A		4040	100	962,57	959,76	-	190	920	102	102	-	91,50

## HTD® 14M-115

Caratteristiche Features Merkmale Características	Codice Code symbol Fabriknummer Code symbole Numero de fabrica	Nostro codice Our code Unser kode Notre code Nuestro codigo	Tipo Type Typ Type Tipo	Tipo flangia Flanges type Bordscheiben Typ Type flasques Tipo tapetas	Bussola Bush Buchse Moyeu Casquillo	Foro max. Max. Bore Max. Bohrung Alesage max. Agujero max.	Dp	De	Df	Dm	Di	F	S	R	Peso Weight / Gewicht Poids / Peso Kg	
Acciaio / Steel / Stahl Acier / Acero	con flangia / with flanges mit Flanges / avec flasques / con tapetas	<b>28-14M-115</b>	<b>1411028</b>	4F	F40	2517	60	124,78	122,12	128	-	98	133	45	44,0	3,77
		<b>29-14M-115</b>	<b>1411029</b>	4F	F43	2517	60	129,23	126,57	138	-	100	133	45	44,0	4,00
		<b>30-14M-115</b>	<b>1411030</b>	4F	F43	2517	60	133,69	130,99	138	-	100	133	45	44,0	5,00
		<b>32-14M-115</b>	<b>1411032</b>	4F	F49	2517	60	142,60	139,88	154	-	108	133	45	44,0	6,80
		<b>34-14M-115</b>	<b>1411034</b>	4F	F51	2517	60	151,52	148,79	160	-	110	133	45	44,0	6,80
		<b>36-14M-115</b>	<b>1411036</b>	4F	F52	3020	75	160,43	157,68	168	-	125	133	51	41,0	7,00
		<b>38-14M-115</b>	<b>1411038</b>	4F	F81	3020	75	169,34	166,60	184	-	130	133	51	41,0	8,40
		<b>40-14M-115</b>	<b>1411040</b>	4F	F56	3020	75	178,25	175,49	188	-	138	133	51	41,0	9,20
		<b>44-14M-115</b>	<b>1411044</b>	4F	F61	3030	75	196,08	193,28	212	-	155	133	76	28,5	14,00
		<b>48-14M-115</b>	<b>1411048</b>	4F	F62	3030	75	213,90	211,11	226	-	170	133	76	28,5	17,10
		<b>56-14M-115</b>	<b>1411056</b>	4F	F66	3535	90	249,55	246,76	256	-	208	133	89	22,0	24,80
<b>64-14M-115</b>	<b>1411064</b>	9WF	F70	3535	90	285,21	282,41	296	190	240	133	89	22,0	27,00		
Ghisa / Castiron / Grauguss Fonte / Hierro fundido	senza flangia / without flanges ohne Flanschen / sans flasques sin tapetas	<b>72-14M-115</b>	<b>1411072</b>	9W		3535	90	320,86	318,06	-	190	280	133	89	22,0	29,00
		<b>80-14M-115</b>	<b>1411080</b>	9A		3535	90	356,51	353,71	-	190	315	133	89	22,0	32,00
		<b>90-14M-115</b>	<b>1411090</b>	9A		3535	90	401,07	398,28	-	190	360	133	89	22,0	36,50
		<b>112-14M-115</b>	<b>1411112</b>	9A		3535	90	499,11	496,32	-	190	457	133	89	22,0	46,00
		<b>144-14M-115</b>	<b>1411144</b>	9A		4040	100	641,71	638,92	-	230	600	133	102	15,5	68,00
		<b>168-14M-115</b>	<b>1411168</b>	9A		4040	100	748,66	745,87	-	230	706	133	102	15,5	82,60
		<b>192-14M-115</b>	<b>1411192</b>	9A		4040	100	855,62	852,82	-	230	813	133	102	15,5	96,00
		<b>216-14M-115</b>	<b>1411216</b>	9A		4040	100	962,57	959,76	-	230	920	133	102	15,5	107,00

## HTD® 14M-170

Caratteristiche Features Merkmale Características	Codice Code symbol Fabriknummer Code symbole Numero de fabrica	Nostro codice Our code Unser kode Notre code Nuestro codigo	Tipo Type Typ Type Tipo	Tipo flangia Flanges type Bordscheiben Typ Type flasques Tipo tapetas	Bussola Bush Buchse Moyeu Casquillo	Foro max. Max. Bore Max. Bohrung Alesage max. Agujero max.	Dp	De	Df	Dm	Di	F	S	R	Peso Weight / Gewicht Poids / Peso Kg	
Acciaio / Steel / Stahl Acier / Acero	con flangia / with flanges mit Flanges / avec flasques con tapetas	<b>38-14M-170</b>	<b>1417038</b>	4F	F81	3030	75	169,34	166,60	184	-	130	187	76	55,5	11,70
		<b>40-14M-170</b>	<b>1417040</b>	4F	F56	3030	75	178,25	175,49	188	-	138	187	76	55,5	13,00
		<b>44-14M-170</b>	<b>1417044</b>	4F	F61	3535	90	196,08	193,28	212	-	153	187	89	49,0	15,00
		<b>48-14M-170</b>	<b>1417048</b>	4F	F62	3535	90	213,90	211,11	226	-	170	187	89	49,0	19,00
		<b>56-14M-170</b>	<b>1417056</b>	4F	F66	3535	90	249,55	246,76	256	-	208	187	89	49,0	28,50
		<b>64-14M-170</b>	<b>1417064</b>	4F	F70	4040	100	285,21	282,41	296	-	240	187	102	42,5	41,00
Ghisa / Castiron / Grauguss Fonte / Hierro fundido	senza flangia / without flanges ohne Flanschen / sans flasques sin tapetas	<b>72-14M-170</b>	<b>1417072</b>	9W		4040	100	320,86	318,06	-	230	280	187	102	42,5	46,90
		<b>80-14M-170</b>	<b>1417080</b>	9W		4040	100	356,51	353,71	-	230	315	187	102	42,5	48,00
		<b>90-14M-170</b>	<b>1417090</b>	9A		4040	100	401,07	398,28	-	230	360	187	102	42,5	52,50
		<b>112-14M-170</b>	<b>1417112</b>	9A		5050	125	499,11	496,32	-	265	457	187	127	30,0	74,50
		<b>144-14M-170</b>	<b>1417144</b>	9A		5050	125	641,71	638,92	-	265	600	187	127	30,0	91,00
		<b>168-14M-170</b>	<b>1417168</b>	9A		5050	125	748,66	745,87	-	265	706	187	127	30,0	116,00
		<b>192-14M-170</b>	<b>1417192</b>	9A		5050	125	855,62	852,82	-	265	813	187	127	30,0	134,00
		<b>216-14M-170</b>	<b>1417216</b>	9A		5050	125	962,57	959,76	-	265	920	187	127	30,0	146,50

**Cinghie dentate**  
**Timing belts**  
**Zahnriemen**  
**Courroies dentées**  
**Correas dentadas**

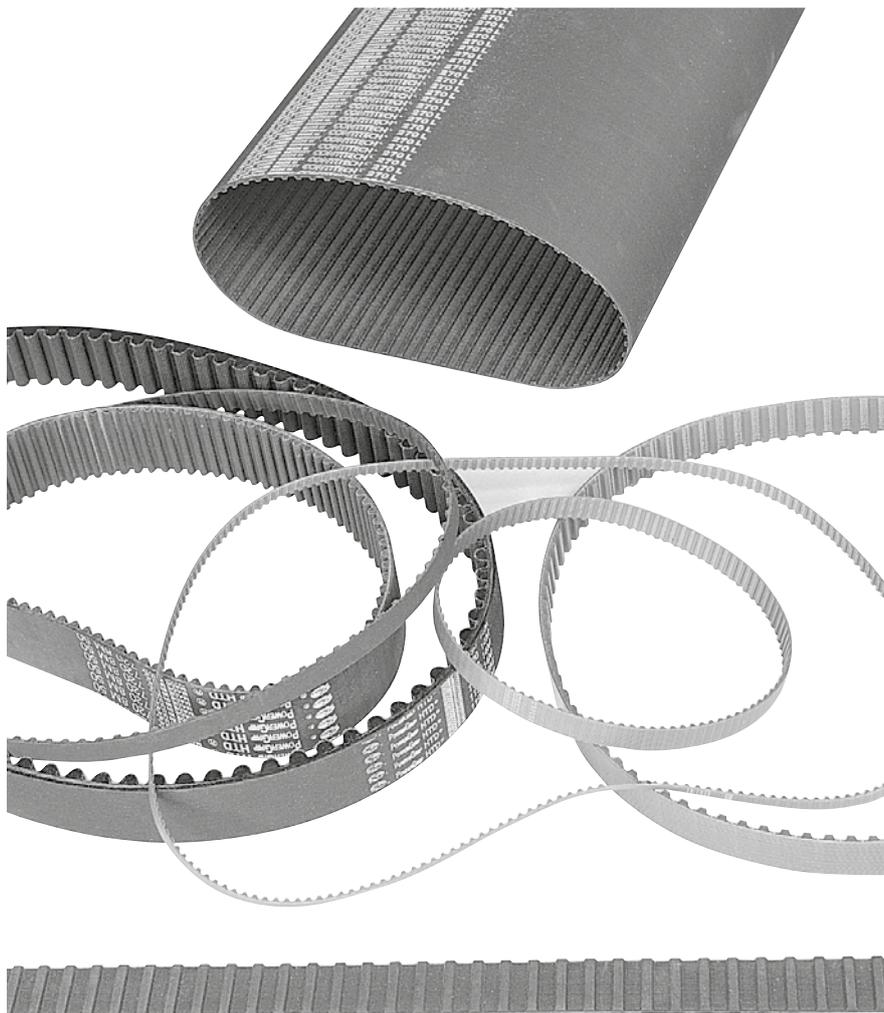

Dal punto di vista strutturale nelle cinghie dentate si possono individuare, come indicato in figura, i seguenti elementi:

From the structural point of view the following elements can be identified in the timing belt as shown in the figure:

Bei Zahnriemen werden in struktureller Hinsicht die folgenden, in Abbildung 1 gezeigten Elemente unterschieden:

Du point de vue structural, l'on distingue dans une courroie, comme indiqué sur la figure, les éléments suivants:

Desde el punto de vista estructural, en las correas dentadas se pueden distinguir los siguientes elementos:

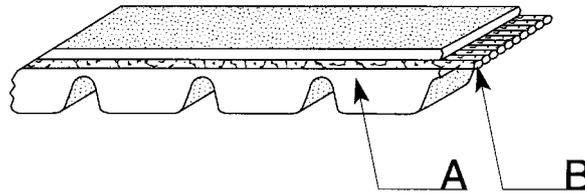

- A) Inserto resistente
- B) Corpo della cinghia
- C) Rivestimento dei denti

- A) Resistive insert
- B) Body of the belt
- C) Tooth covering

- A) Verstärkungseinlage
- B) Riemenkörper
- C) Zahnverkleidung

- A) Armature résistante
- B) Corps de la courroie
- C) Revêtement des dents

- A) Inserto de refuerzo
- B) Cuerpo de la correa
- C) Revestimiento de los dientes

L'inserto resistente è l'elemento che costituisce l'anima della cinghia, sopporta interamente i carichi ed è costituito da una tortiglia di materiale ad elevato carico di rottura con ottima resistenza alle flessioni ripetute e assoluta inestensibilità. L'inserto è avvolto a spirale per tutta la larghezza della cinghia e la sua posizione determina la linea primitiva della stessa.

The resistive insert is the element constituting the core of the belt. It fully bears the loads and consists of a cord of material with high breaking load, first-class resistance to repeated flexion and is completely inextensible. The insert is wound spiral fashion the full length of the belt and its position determines the belt's pitch line.

Der Kern des Riemens bildet die Verstärkungseinlage. Sie trägt die volle Last und besteht aus einem Cordfaden mit hoher Zugfestigkeit, ausgezeichneter Dauerbiegefestigkeit und sehr geringer Dehnung. Die Verstärkungseinlage ist auf der gesamten Breite des Riemen gewickelt und ihre Lage bestimmt die Wirklinie.

L'armature résistante constitue l'âme de la courroie, elle supporte entièrement les charges et est composée d'un cordonnet de matériau à haute charge de rupture offrant une résistance optimale aux flexions répétées et une inextensibilité absolue. L'armature est enroulée en spirale sur toute la largeur de la courroie, dans lequel l'armature résistante est noyée, sont en néoprène, ce dernier présente les caractéristiques suivantes: résistance exceptionnelle à la fatigue, excellente résistance à la chaleur, bonne résistance aux huiles de lubrification minérales et indéformabilité dans le temps.

El inserto de refuerzo constituye el alma de la correa, soporta enteramente la carga y está formado por un torzal de material con elevada carga de rotura, óptima resistencia a la flexión repetida y absoluta inextensibilidad. El inserto está envuelto en espiral en todo el ancho de la correa y su posición determina la línea primitiva de esta última.

I denti e il corpo della cinghia nel quale è annesso l'inserto resistente sono in neoprene le cui caratteristiche sono: l'eccezionale resistenza alla fatica, l'ottima resistenza al calore, la buona resistenza agli olii lubrificanti minerali e l'indeformabilità nel tempo.

The teeth and body of the belt in which the resistive insert is sunk are made of neoprene which has the following characteristics: outstanding resistance to fatigue, excellent heat resistance, good resistance to mineral oil lubricants and does not deform over time.

Zähne und Körper des Riemen, in den die Verstärkungseinlage eingelassen ist, sind aus Neopren mit folgenden Eigenschaften: ausgezeichnete Ermüdungsfestigkeit, optimale Hitzebeständigkeit, resistent gegen mineralische Schmieröle und dauer-Gaffe Formbeständigkeit. Die Verkleidung der Zähne an der Innenseite des Riemen, die mit der Riemen-scheibe in Kontakt steht, besteht aus einem speziellen Nylongewebe, das fest am Riemenkörper verankert ist. Dieses Gewebe hat die Aufgabe den Reibwert herabzusetzen und die Antriebskraft zu erhöhen.

Le revêtement des dents dans la partie intérieure de la courroie en contact avec la poulie est réalisée dans un tissu spécial en nylon, fortement ancré au corps de la courroie. Ce tissu a pour rôle de diminuer le coefficient de frottement et d'augmenter le rendement de la transmission. Ce matériau a en outre un haut pouvoir lubrifiant qui augmente durant le fonctionnement.

Los dientes y el cuerpo de la correa, en el cual está hundido el inserto de refuerzo, son de neopreno con las siguientes propiedades: excepcional resistencia a los aceites lubricantes minerales e indeformabilidad a lo largo del tiempo.

Il rivestimento dei denti nella parte interna della cinghia a contatto con la puleggia viene eseguito con uno speciale tessuto in nylon fortemente ancorato al corpo della cinghia, questo tessuto ha il compito di diminuire il coefficiente di attrito e di alzare il rendimento della trasmissione.

The tooth covering on the inside the belt that is in contact with of the pulleys is made of a special nylon fabric solidly anchored to the body of the belt. The fabric's job is to reduce the friction coefficient and increase transmission efficiency. This material also has a high level of lubricating power that increases during operation.

Das Material besitzt daneben eine hohe Schmierfähigkeit, die sich während dem Betrieb noch zusätzlich erhöht.

## Caratteristiche dimensionali:

Gli elementi che contraddistinguono il tipo di cinghia sono:

- 1<sup>o</sup>) Lunghezza primitiva
- 2<sup>o</sup>) Tipo
- 3<sup>o</sup>) Larghezza

Esempio: 670 XH 300

Il primo numero indica il valore della lunghezza primitiva ed è espresso in decimi di pollice (vedi tabelle pag. 5-6).

Le lettere caratterizzano il passo e quindi il tipo di cinghia (XL - 1/5" (5,08) - L - 3/8" (9,525) ecc.). L'ultimo numero indica il valore della larghezza della cinghia ed è espresso in centesimi di pollice.

## Dimensional characteristics:

The elements distinguishing this type of belt are:

- 1<sup>st</sup>) Pitch line length
- 2<sup>nd</sup>) Type
- 3<sup>rd</sup>) Width

Example 670 XH 300

The first number indicates the pitch line length value and is expressed in tenths of inches (see table on page 5-6).

The letters stand for the pitch and then the type of belt (XL1/5 (5,00) L=3/8" (9,525) etc.).

The last number indicates the belt width value and is expressed in hundredths of an inch.

## Dimensions-Karakteristiken:

Die den Riementyp kennzeichnenden Elemente sind:

- 1) Wirklänge
- 2) Typ
- 3) Breite

Beispiel: 670 XH 300

Die erste Zahl gibt den Wert der Wirklänge in Zehnteilzoll an (siehe Tabelle Seite 5-6).

Die Buchstaben stehen für die Teilung und den Typ damit des Riemen (XL=1/5" (5,00) L=3/8" (9,525) usw.).

Die letzte Zahl gibt die Breite des Riemen in Zehnteilzoll an.

## Dimensions:

Les éléments qui permettent de distinguer le type d'une courroie sont:

- 1) La longueur primitive
- 2) Le type
- 3) La largeur

Exemple: 670 XH 300

Le premier nombre indique la valeur de la longueur primitive et est exprimé en dixièmes de pouce (voir tableau p. 5-6).

Les lettres caractérisent le pas et donc le type de courroie (XL = 1/5" (5,00), L=3/8" (9,525), etc ...).

Le dernier nombre indique la valeur de la largeur de la courroie et est exprimé en centièmes de pouce.

## Características dimensionales

Las características distintivas de este tipo de correa se indican de la siguiente manera:

- 1) Longitud primitiva
- 2) Tipo
- 3) Ancho

Ejemplo: 670 XH 300

El primer número indica la longitud primitiva, expresada en décimas de pulgada (véase la tabla de pag. 5-6).

Las letras definen el paso y, por lo tanto, el tipo de correa (XL - 1/5" (5,00) - L = 3/8" (9,525), etc.).

El último número indica el ancho de la correa y se expresa en centésimas de pulgada.

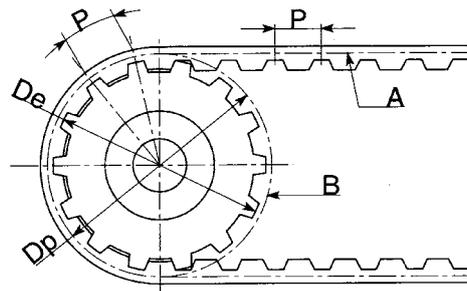

**A)** Linea primitiva della cinghia  
**B)** Circonferenza primitiva della cinghia

**A)** Belt pitch line  
**B)** Belt pitch circumference

**A)** Teilreislinie des Riemens  
**B)** Teilkreis des Riemens

**A)** Ligne primitive de la courroie  
**B)** Circonférence primitive de la courroie

**A)** Linea primitiva de la correa  
**B)** Circunferencia primitiva de la correa

**Simbologia**

**lp** Lunghezza primitiva  
**P** Passo  
**Lc** Larghezza cinghia  
**Lp** Larghezza puleggia  
**Z** Numero dei denti  
**Dp** Diametro primitivo puleggia  
**De** Diametro esterno puleggia

**Legend**

**lp** Pitch line length  
**P** Pitch  
**Lc** Belt width  
**Lp** Pulley width  
**Z** Number of teeth  
**Dp** Pulley pitch diameter  
**De** Outer pulley diameter

**Symbol**

**lp** Wirklänge  
**P** Teilung  
**Lc** Riemenbreite  
**Lp** Scheibenbreite  
**Z** Zähnezahl  
**Dp** Teilkreisdurchmesser  
**De** Außendurchmesser der Scheibe

**Symboles**

**lp** Longueur primitive  
**P** Pas  
**Lc** Largeur de la courroie  
**Lp** Largeur de la poulie  
**Z** Nombre de dents  
**Dp** Diamètre primitif de la poulie  
**De** Diamètre extérieur de la poulie

**Simbologia**

**lp** Longitud primitiva  
**P** Paso  
**Lc** Ancho de la correa  
**Lp** Ancho de la polea  
**Z** Número de dientes  
**Dp** Diámetro primitivo polea  
**De** Diámetro externo polea

**Definizioni**

**lp - lunghezza primitiva**  
 è lo sviluppo della cinghia misurato sulla linea primitiva che corrisponde all'asse dell'inserto resistente.

**Definitions**

**lp - pitch line length**  
 is the belts' progress measured on the pitch line that corresponds to the resistive insert axis.

**Begriffsbestimmungen**

**lp - Wirklänge**  
 ist die in der Achse der Verstärkungseinlage gemessene Riemenlänge.

**Definitions**

**lp - longueur primitive**  
 est le développement de la courroie mesuré sur la ligne primitive qui correspond à l'axe de l'armature résistante.

**Definiciones**

**lp - longitud primitiva**  
 Es el desarrollo de la correa, medido sobre la línea primitiva (que corresponde al eje del inserto de refuerzo).

**P - passo**

è la distanza fra gli assi di due denti contigui siano essi quelli della puleggia o della cinghia purché misurata sulla circonferenza o sulla linea primitiva. Il passo della cinghia e il passo della puleggia debbono avere lo stesso valore. Per avere una perfetta trasmissione la linea primitiva della cinghia deve coincidere con la circonferenza primitiva della puleggia.

**P - pitch**

is the distance between the axes of two contiguous teeth whether of the pulley or the belt provided they are measured on the pitch line or circle. The pitch of the belt and the pitch of the pulley must have the same value. To get perfect drive, the pitch line of the belt must correspond with the pitch circle of the pulley.

**P - teilung**

ist der Abstand zwischen den Achsen zweier angrenzender Zähne der Scheibe oder des Riemens, der an der Kreislinie und an der Wirklinie gemessen wird. Riemen-teilung und Scheibenteilung müssen gleich sein. Für einen perfekten Antrieb muß die Wirklinie des Riemens mit dem Teilkreisdurchmesser der Scheibe übereinstimmen.

**P - pas**

est la distance entre les axes de deux dents contiguës; ces dernières peuvent appartenir aussi bien à la poulie qu'à la courroie, à condition que l'on effectue la mesure sur la circonférence ou sur la ligne primitive. Le pas de la courroie et le pas de la poulie doivent avoir la même valeur. Pour que la transmission soit parfaite, la ligne primitive de la courroie doit coïncider avec la circonférence primitive de la poulie.

**P - paso**

Distancia entre los ejes de dos dientes adyacentes, tanto de la polea como de la correa, siempre que se mida sobre la circunferencia o sobre la línea primitiva. La correa y la polea tienen que tener el mismo paso. Para que la transmisión sea perfecta, la línea primitiva de la correa debe coincidir con la circunferencia primitiva de la polea.

**Dp - diametro primitivo della puleggia**

Questo diametro definisce in linea teorica la posizione della circonferenza primitiva che è sempre maggiore del diametro esterno della puleggia. Il diametro primitivo può essere facilmente ricavato per mezzo della relazione  $P \cdot Z = \pi \cdot Dp$  da cui:

**Dp - pitch diameter of the pulley**

This diameter theoretically defines the position of the pitch circle that is always greater than the outer diameter of the pulley. The pitch diameter can be easily obtained by means of the ratio  $P \cdot Z = \pi \cdot Dp$  therefore:

**Dp - Teilkreisdurchmesser der Scheibe**

Dieser Durchmesser definiert die logische Linie der Kreislinie, die stets größer ist als der Außendurchmesser der Scheibe. Der Teilkreisdurchmesser wird mit der folgenden Formel ermittelt  $P \cdot Z = \pi \cdot Dp$ :

**Dp - diametre primitif de la poulie**

Ce diamètre défini en ligne théorique la position de la circonférence primitive qui est toujours plus grande que le diamètre extérieur de la poulie. Le diamètre primitif peut facilement être retrouvé par la relation  $P \cdot Z = \pi \cdot Dp$  d'où:

**Dp - diametro primitivo de la polea**

Define teoricamente la posición de la circunferencia primitiva, que es siempre mayor que el diámetro externo de la polea. El diámetro primitivo se puede calcular mediante la relación  $P \cdot Z = \pi \cdot Dp$ , por lo cual:

$$Dp = \frac{P \cdot Z}{\pi}$$

**Lc - Lp larghezza cinghia - larghezza puleggia**

Sono nominalmente uguali e sono determinate dalla potenza da trasmettere. Vengono fissate in sede di progetto. La puleggia è in realtà più larga perchè tiene conto dei giochi di funzionamento e delle tolleranze di costruzione delle cinghie stesse.

**Lc - Lp belt width - pulley width**

These are nominally the same and are determined by the power to be transmitted. They are established at the design stage. The pulley is in reality wider because it takes account of the operating peaks and the tolerances in the belt construction itself.

**Lc - Lp Riemenbreite - Scheibenbreite**

Diese Werte sind nominal gleich und hängen von der zu Übertragenden Kraft ab. Sie werden bei der Projektausarbeitung bestimmt. Die Scheibe ist in Wirklichkeit breiter, da sie das Betriebspiel und die Konstruktionstoleranzen des Riemens berücksichtigt.

**Lc - Lp largeur de la courroie - largeur de la poulie**

Elles sont nominallement égales et sont déterminées par la puissance à transmettre. Elles sont fixées au stade de conception. La poulie est en réalité plus large parce qu'elle tient compte des jeux de fonctionnement et des tolérances de construction des courroies elles-mêmes.

**Lc - Lp ancho de la correa - ancho de la polea**

Son nominalmente iguales, dependen de la potencia que se debe transmitir y se definen en el proyecto. En realidad, el ancho de la polea es mayor porque contempla los juegos de funcionamiento y las tolerancias de fabricación de la correa.

**Applicazioni pratiche più comuni in relazione al passo**  
**Most common practical applications with respect to the pitch**  
**Anwendungen der verschiedenen Teilung**  
**Applications pratiques les plus courantes en fonction du pas**  
**Aplicaciones practicas mas comunes en funcion del paso**

<b>Passo della cinghia Belt pitch / Riementeilung Pas de la courroie / Paso de la correa</b>			<b>Applicazioni più comuni Most common applications Übliche anwendungen Applications les plus courantes Aplicaciones más comunes</b>
Codice Code / Code Code / Código	Pollici Inches / Zoll Pouces / Pulgadas	mm	
XL	1/5	5,080	<p>Piccole trasmissioni su macchine di precisione, quali macchine cinematografiche, da scrivere, calcolatrici, elettrodomestici, ecc.            Small transmissions on precision machines like film projectors etc., typewriters, calculators and electrical appliances etc.            Kleinere Antriebe an Präzisionsmaschinen, wie Kinematographiemaschinen, Schreib- und Rechenmaschinen, Haushaltgeräte, usw.            Petites transmissions pour les machines de précision comme les machines cinématographiques, à écrire, calculatrices, appareils électroménagers, etc.            Pequeñas transmisiones en aparatos de precisión, como máquinas cinematográficas, de escribir, calculadoras, electrodomésticos, etc.</p>
L	3/8	9,525	<p>Applicazioni su macchine di piccola potenza, quali macchine utensili, da cucire, lavatrici, ecc.            Applications on small-power machines such as machine tools, sewing machines, washing machines, etc.            Anwendung bei Maschinen mit geringer Leistung, wie Werkzeugmaschinen, Nähmaschinen, Waschmaschinen, usw.            Applications sur des machines de faible puissance comme les machines-outils, à coudre, à laver, etc.            Máquinas de baja potencia, como máquinas herramientas, de coser, lavadoras, etc.</p>
H	1/2	12,700	<p>Applicazioni su macchine di media potenza, quali macchine utensili, macchine tessili, da legno, per cartiere, ecc.            Applications on medium-power machines such as machine tools, textile machines, wood-working machines, papermill machinery etc.            Anwendung bei Maschinen mittlerer Leistung, wie Werkzeugmaschinen, Textilmaschinen, Holzverarbeitungs- und Baumaschinen, usw.            Applications sur des machines de puissance moyenne comme les machines-outils, machines textiles, bois, pour la papeterie, etc.            Aparatos de potencia media, como máquinas herramientas, textiles, para madera, fabricación de papel, etc.</p>
XH	7/8	22,225	<p>Applicazioni su trasmissioni industriali in genere, aventi potenze medie.            Applications on industrial transmissions in general with medium power.            Anwendung bei industriellen Antrieben mittlerer Leistung.            Applications sur des transmissions industrielles en général, ayant des puissances moyennes.            Transmisiones industriales en general, de potencia media.</p>
XXH	1" 1/4	31,750	<p>Applicazioni su trasmissioni industriali di media e grande potenza.            Applications on medium and large power industrial transmission.            Anwendung bei industriellen Antrieben mittlerer und großer Leistung.            Applications sur transmissions industrielles de moyenne et grande puissance.            Transmisiones industriales de potencia media y alta.</p>



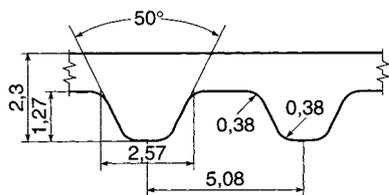

**Tipo / Type XL**

(valori medi - mm) / (Medium values - mm) / (Mittelwerte - mm)  
(Valeurs moyennes - mm) / (Valores medios - mm)

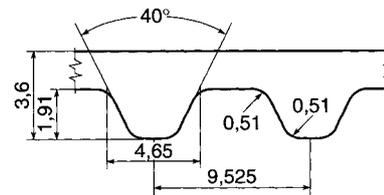

**Tipo / Type L**

(valori medi - mm) / (Medium values - mm) / (Mittelwerte - mm)  
(Valeurs moyennes - mm) / (Valores medios - mm)

## Codice XL

Passo 1/5" (mm 5,08) / Pitch 1/5" (mm 5,08) / Teilung 1/5" (mm 5,08)  
Pas 1/5" (mm 5,08) / Paso 1/5" (mm 5,08)

Tipo cinghia Belt type Riementyp Type de courroie Tipo de correa	N. denti N. of teeth Zahnezahl N. bre de dents Cantidad de dientes	Sviluppo / Circumference / Länge Developpement / Desarrollo	
		Pollici / Inches / Zoll Pouces / Pulgadas	mm
54 XL	27	5,40	137,16
60 XL	30	6,00	152,40
70 XL	35	7,00	177,80
80 XL	40	8,00	203,20
90 XL	45	9,00	228,60
98 XL	49	9,80	248,92
100 XL	40	10,00	254,00
102 XL	51	10,20	259,08
106 XL	53	10,60	269,24
110 XL	55	11,00	279,40
120 XL	60	12,00	304,80
130 XL	65	13,00	330,20
140 XL	70	14,00	355,60
150 XL	75	15,00	381,00
156 XL	78	15,60	396,24
160 XL	80	16,00	406,40
170 XL	85	17,00	431,80
180 XL	90	18,00	457,20
182 XL	91	18,20	462,28
190 XL	95	19,00	482,60
198 XL	99	19,80	502,92
200 XL	100	20,00	508,00
202 XL	101	20,20	513,08
210 XL	105	21,00	533,40
212 XL	106	21,20	538,48
214 XL	107	21,40	543,56
220 XL	110	22,00	558,80
228 XL	114	22,80	579,12
230 XL	115	23,00	584,20
234 XL	117	23,40	594,36
240 XL	120	24,00	609,60
250 XL	125	25,00	635,00
260 XL	130	26,00	660,40
270 XL	135	27,00	685,80
276 XL	138	27,60	701,04
290 XL	145	29,00	736,60
300 XL	150	30,00	762,00
310 XL	155	31,00	787,40
316 XL	158	31,60	802,64
320 XL	160	32,00	812,80
330 XL	165	33,00	838,20
344 XL	172	34,40	873,76
352 XL	176	35,20	894,08
364 XL	182	36,40	924,56
380 XL	190	38,00	965,20
384 XL	192	38,40	975,36
390 XL	195	39,00	990,60
392 XL	196	39,20	995,68
434 XL	217	43,40	1102,36
530 XL	265	53,00	1346,20
600 XL	300	60,00	1524,00
710 XL	355	71,00	1803,40

Larghezze unificate / Standardised widths  
Standardbreiten / Largeurs unifiées / Anchos unificados

Codice / Code symbol Fabriknummer / Code symbole Numero de fabrica	Pollici / Inches / Zoll Pouces / Pulgadas	mm
* 025	1/4	6,350
* 031	5/16	7,940
* 037	3/8	9,525

\* Cinghie di stock.

\* Timing belts in stock.

\* Lager-Breiten.

Per le cinghie con numero di denti non compresi in queste tabelle consultate il nostro servizio tecnico. Per gli sviluppi indicati sono fornibili i relativi manicotti.

For timing belts with a number of teeth not specified in these tables consult our technical department.

Für Riemen mit nicht in dieser Tabelle enthaltener Zähnezahl wenden Sie sich an unseren technischen Kundendienst.

## Codice L

Passo 3/8" (mm 9,525) / Pitch 3/8" (mm 9,525) / Teilung 3/8" (mm 9,525)  
Pas 3/8" (mm 9,525) / Paso 3/8" (mm 9,525)

Tipo cinghia Belt type Riementyp Type de courroie Tipo de correa	N. denti N. of teeth Zahnezahl N. bre de dents Cantidad de dientes	Sviluppo / Circumference / Länge Developpement / Desarrollo	
		Pollici / Inches / Zoll Pouces / Pulgadas	mm
124 L	33	12,37	314,33
135 L	36	13,50	342,90
150 L	40	15,00	381,00
173 L	46	17,25	438,15
187 L	50	18,75	476,25
202 L	54	20,25	514,35
210 L	56	21,00	533,40
225 L	60	22,50	571,50
240 L	64	24,00	609,60
255 L	68	25,50	647,70
270 L	72	27,00	685,80
285 L	76	28,50	723,90
300 L	80	30,00	762,00
322 L	86	32,25	819,15
345 L	92	34,50	876,20
367 L	98	36,75	933,45
390 L	104	39,00	990,60
405 L	108	40,50	1028,70
412 L	110	41,25	1047,75
420 L	112	42,00	1066,80
450 L	120	45,00	1143,00
480 L	128	48,00	1219,20
510 L	136	51,00	1295,40
540 L	144	54,00	1371,60
600 L	160	60,00	1524,00
728 L	194	72,75	1847,85
817 L	218	81,75	2076,45

Larghezze unificate / Standardised widths  
Standardbreiten / Largeurs unifiées / Anchos unificados

Codice / Code symbol Fabriknummer / Code symbole Numero de fabrica	Pollici / Inches / Zoll Pouces / Pulgadas	mm
* 050	1/2	12,70
* 075	3/4	19,05
* 100	1"	25,40

\* Courroies de stock.

\* Correas en existencia.

Consulter notre service technique pour des courroies ayant un nombre de dents ne figurant pas dans ce tableau.

Para correas cuyo número de dientes no figure en esta tabla, consultar con el servicio, técnico de la empresa.

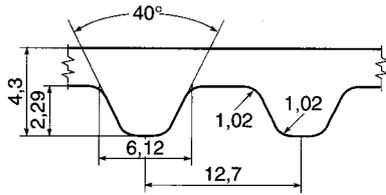

### Tipo / Type H

(valori medi - mm) / (Medium values - mm) / (Mittelwerte - mm)  
(Valeurs moyennes - mm) / (Valores medios - mm)

## Codice H

Passo 1/2" (mm 12,7) / Pitch 1/2" (mm 12,7) / Teilung 1/2" (mm 12,7)  
Pas 1/2" (mm 12,7) / Paso 1/2" (mm 12,7)

Tipo cinghia Belt type Riementyp Type de courroie Tipo de correa	N. denti N. of teeth Zahnezahl N. bre de dents Cantidad de dientes	Sviluppo / Circumference / Länge Developpement / Desarrollo	
		Pollici / Inches / Zoll Pouces / Pulgadas	mm
240 H	48	24,00	609,60
270 H	54	27,00	685,80
300 H	60	30,00	762,00
330 H	66	33,00	838,20
360 H	72	36,00	914,40
390 H	78	39,00	990,60
420 H	84	42,00	1066,80
450 H	90	45,00	1143,00
480 H	96	48,00	1219,20
510 H	102	51,00	1295,40
540 H	108	54,00	1371,60
570 H	114	57,00	1447,80
600 H	120	60,00	1524,00
630 H	126	63,00	1600,20
660 H	132	66,00	1676,40
700 H	140	70,00	1778,00
725 H	145	72,50	1841,50
750 H	150	75,00	1905,00
800 H	160	80,00	2032,00
850 H	170	85,00	2159,00
900 H	180	90,00	2286,00
1000 H	200	100,00	2540,00
1100 H	220	110,00	2794,00
1120 H	224	112,00	2844,80
1140 H	228	114,00	2895,60
1150 H	230	115,00	2921,00
1250 H	250	125,00	3175,00
1400 H	280	140,00	3556,00
1700 H	340	170,00	4318,00

Larghezze unificate / Standardised widths  
Standardbreiten / Largeurs unifiées / Anchos unificados

Codice / Code symbol Fabriknummer / Code symbole Numero de fabrica	Pollici / Inches / Zoll Pouces / Pulgadas	mm
* 075	3/4	19,05
* 100	1"	25,40
* 150	1" 1/2	38,10
* 200	2"	50,80
* 300	3"	76,20

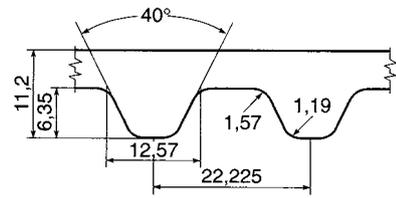

### Tipo / Type XH

(valori medi - mm) / (Medium values - mm) / (Mittelwerte - mm)  
(Valeurs moyennes - mm) / (Valores medios - mm)

## Codice XH

Passo 7/8" (mm 22,225) / Pitch 7/8" (mm 22,225) / Teilung 7/8" (mm 22,225)  
Pas 7/8" (mm 22,225) / Paso 7/8" (mm 22,225)

Tipo cinghia Belt type Riementyp Type de courroie Tipo de correa	N. denti N. of teeth Zahnezahl N. bre de dents Cantidad de dientes	Sviluppo / Circumference / Länge Developpement / Desarrollo	
		Pollici / Inches / Zoll Pouces / Pulgadas	mm
507 XH	58	50,75	1289,05
560 XH	64	56,00	1422,40
630 XH	72	63,00	1600,20
700 XH	80	70,00	1778,00
770 XH	88	77,00	1955,80
840 XH	96	84,00	2133,60
980 XH	112	98,00	2489,20
1120 XH	128	112,00	2844,80
1260 XH	144	126,00	3200,40
1400 XH	160	140,00	3556,00
1540 XH	176	154,00	3911,60
1750 XH	200	175,00	4445,00

Larghezze unificate / Standardised widths  
Standardbreiten / Largeurs unifiées / Anchos unificados

Codice / Code symbol Fabriknummer / Code symbole Numero de fabrica	Pollici / Inches / Zoll Pouces / Pulgadas	mm
* 200	2	50,80
* 300	3	76,20
* 400	4	101,60

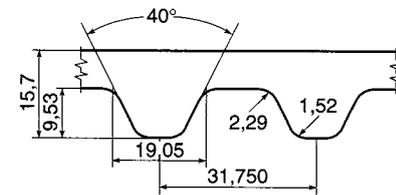

### Tipo / Type XXH

(valori medi - mm) / (Medium values - mm) / (Mittelwerte - mm)  
(Valeurs moyennes - mm) / (Valores medios - mm)

## Codice XXH

Passo 1" 1/4 (mm 31,75) / Pitch 1" 1/4 (mm 31,75) / Teilung 1" 1/4 (mm 31,75)  
Pas 1" 1/4 (mm 31,75) / Paso 1" 1/4 (mm 31,75)

Tipo cinghia Belt type Riementyp Type de courroie Tipo de correa	N. denti N. of teeth Zahnezahl N. bre de dents Cantidad de dientes	Sviluppo / Circumference / Länge Developpement / Desarrollo	
		Pollici / Inches / Zoll Pouces / Pulgadas	mm
700 XXH	56	70,00	1778,00
800 XXH	64	80,00	2032,00
900 XXH	72	90,00	2286,00
1000 XXH	80	100,00	2540,00
1200 XXH	96	120,00	3048,00
1400 XXH	112	140,00	3556,00
1600 XXH	128	160,00	4064,00
1800 XXH	144	180,00	4572,00

Larghezze unificate / Standardised widths  
Standardbreiten / Largeurs unifiées / Anchos unificados

Codice / Code symbol Fabriknummer / Code symbole Numero de fabrica	Pollici / Inches / Zoll Pouces / Pulgadas	mm
* 200	2	50,80
* 300	3	76,20
* 400	4	101,60
* 500	5	127,00

# Cinghie dentate positive a doppia dentatura / Double toothed timing belts Zahnriemen mit beidseitiger Verzahnung / Courroies dentées positives à double denture Correas dentadas positivas con doble dentado



## Codice XL

Passo 1/5" (mm 5,08) / Pitch 1/5" (mm 5,08) / Teilung 1/5" (mm 5,08)  
Pas 1/5" (mm 5,08) / Paso 1/5" (mm 5,08)

Tipo cinghia Belt type Riementyp Type de courroie Tipo de correa	N. denti N. of teeth Zahnezahl N. bre de dents Cantidad de dientes	Sviluppo / Circumference / Länge Developpement / Desarrollo	
		Pollici / Inches / Zoll Pouces / Pulgadas	mm
*DD 60 XL	30	6,00	152,40
*DD 70 XL	35	7,00	177,80
*DD 80 XL	40	8,00	203,20
*DD 90 XL	45	9,00	228,60
*DD 100 XL	50	10,00	254,00
DD 110 XL	55	11,00	279,40
DD 120 XL	60	12,00	304,80
DD 130 XL	65	13,00	330,20
DD 140 XL	70	14,00	355,60
DD 150 XL	75	15,00	381,00
*DD 156 XL	78	15,60	396,24
DD 160 XL	80	16,00	406,40
DD 170 XL	85	17,00	431,80
DD 180 XL	90	18,00	457,20
*DD 182 XL	91	18,20	462,28
DD 190 XL	95	19,00	482,60
*DD 198 XL	99	19,80	502,92
DD 200 XL	100	20,00	508,00
*DD 202 XL	101	20,20	513,08
DD 210 XL	105	21,00	533,40
*DD 212 XL	106	21,20	538,48
*DD 214 XL	107	21,40	543,56
DD 220 XL	110	22,00	558,80
*DD 228 XL	114	22,80	579,12
DD 230 XL	115	23,00	584,20
DD 240 XL	120	24,00	609,60
DD 250 XL	125	25,00	635,00
DD 260 XL	130	26,00	660,40
*DD 270 XL	135	27,00	685,80
*DD 276 XL	138	27,60	701,04
DD 290 XL	145	29,00	736,60
DD 300 XL	150	30,00	762,00
DD 310 XL	155	31,00	787,40
*DD 316 XL	158	31,60	802,64
*DD 320 XL	160	32,00	812,80
DD 330 XL	165	33,00	838,20
*DD 344 XL	172	34,40	873,76
*DD 352 XL	176	35,20	894,08
DD 362 XL	181	36,20	919,48
*DD 364 XL	182	36,40	924,56
*DD 380 XL	190	38,00	965,20
*DD 384 XL	192	38,40	975,36
*DD 390 XL	195	39,00	990,60
DD 392 XL	196	39,20	995,68
*DD 434 XL	217	43,40	1102,36
DD 450 XL	225	45,00	1143,00
DD 492 XL	246	49,20	1249,68
*DD 600 XL	300	60,00	1524,00
DD 696 XL	345	69,00	1752,60
*DD 900 XL	450	90,00	2286,00

Larghezze unificate / Standardised widths  
Standardbreiten / Largeurs unifiées / Anchos unificados

Codice / Code symbol Fabriknummer / Code symbole Numero de fabrica	Pollici / Inches / Zoll Pouces / Pulgadas	mm
025	1/4	6,35
037	3/8	9,525

## Codice L

Passo 1/5" (mm 5,08) / Pitch 1/5" (mm 5,08) / Teilung 1/5" (mm 5,08)  
Pas 1/5" (mm 5,08) / Paso 1/5" (mm 5,08)

Tipo cinghia Belt type Riementyp Type de courroie Tipo de correa	N. denti N. of teeth Zahnezahl N. bre de dents Cantidad de dientes	Sviluppo / Circumference / Länge Developpement / Desarrollo	
		Pollici / Inches / Zoll Pouces / Pulgadas	mm
DD 124 L	33	12,37	314,33
DD 150 L	40	15,00	381,00
*DD 173 L	46	17,25	438,15
DD 187 L	50	18,75	476,25
*DD 202 L	54	20,25	514,35
DD 210 L	56	21,00	533,40
DD 225 L	60	22,50	571,50
DD 240 L	64	24,00	609,60
DD 255 L	68	25,50	647,70

Per gli sviluppi indicati sono fornibili i relativi manicotti.

The relative sleeves can be supplied for the sizes indicated.

Für die angegebenen Längen stehen die entsprechenden Werkzeuge zur Verfügung.

Pour les développements indiqués, les manchons correspondant peuvent être fournis.

Para los desarrollos indicados se dispone de los respectivos manguitos.

\* Le misure contrassegnate con asterisco non sono tenute in stock, si producono a richiesta con minimo di fornitura da concordare.

\* The lengths marked with an asterisk are not kept in stock, they are manufactured to order with a minimum manufacturing run to be agreed.

\* Die mit Sternchen bezeichneten Maße sind nicht auf Lager vorhanden, können aber auf zu vereinbarenden Mindestaufträge produziert werden.

\* Les dimensions signalées par un astérisque ne sont pas en stock, elles sont produites sur demande; minimum de fourniture à accorder.

\* Las medidas marcadas con asterisco no se encuentran en existencia, sino que se fabrican sobre pedido, en cantidades mínimas que se deberán convenir por anticipado.

## Codice L

Passo 1/5" (mm 5,08) / Pitch 1/5" (mm 5,08) / Teilung 1/5" (mm 5,08)  
Pas 1/5" (mm 5,08) / Paso 1/5" (mm 5,08)

Tipo cinghia Belt type Riementyp Type de courroie Tipo de correa	N. denti N. of teeth Zahnezahl N. bre de dents Cantidad de dientes	Sviluppo / Circumference / Länge Developpement / Desarrollo	
		Pollici / Inches / Zoll Pouces / Pulgadas	mm
DD 270 L	72	27,00	685,80
DD 285 L	76	28,50	723,90
DD 300 L	80	30,00	762,00
DD 322 L	86	32,25	819,15
DD 345 L	92	34,50	876,20
DD 367 L	98	36,75	933,45
DD 390 L	104	39,00	990,60
*DD 405 L	108	40,50	1028,70
*DD 412 L	110	41,25	1047,75
DD 420 L	112	42,00	1066,80
DD 450 L	120	45,00	1143,00
DD 480 L	128	48,00	1219,20
DD 510 L	136	51,00	1295,40
DD 540 L	144	54,00	1371,60
DD 600 L	160	60,00	1524,00
DD 660 L	176	66,00	1676,40
*DD 728 L	194	72,75	1847,85
*DD 817 L	218	81,75	2076,45

Larghezze unificate / Standardised widths  
Standardbreiten / Largeurs unifiées / Anchos unificados

Codice / Code symbol Fabriknummer / Code symbole Numero de fabrica	Pollici / Inches / Zoll Pouces / Pulgadas	mm
* 050	1/2	12,70
* 075	3/4	19,05
* 100	1"	25,40

## Codice H

Passo 1/2" (mm 12,7) / Pitch 1/2" (mm 12,7) / Teilung 1/2" (mm 12,7)  
Pas 1/2" (mm 12,7) / Paso 1/2" (mm 12,7)

Tipo cinghia Belt type Riementyp Type de courroie Tipo de correa	N. denti N. of teeth Zahnezahl N. bre de dents Cantidad de dientes	Sviluppo / Circumference / Länge Developpement / Desarrollo	
		Pollici / Inches / Zoll Pouces / Pulgadas	mm
DD 240 H	48	24,00	609,60
DD 270 H	54	27,00	685,80
DD 300 H	60	30,00	762,00
DD 330 H	66	33,00	838,20
DD 360 H	72	36,00	914,40
DD 390 H	78	39,00	990,60
DD 420 H	84	42,00	1066,80
DD 450 H	90	45,00	1143,00
DD 480 H	96	48,00	1219,20
DD 510 H	102	51,00	1295,40
DD 540 H	108	54,00	1371,60
DD 570 H	114	57,00	1447,80
DD 600 H	120	60,00	1524,00
DD 630 H	126	63,00	1600,20
DD 660 H	132	66,00	1676,40
DD 700 H	140	70,00	1778,00
*DD 725 H	145	72,50	1841,50
DD 750 H	150	75,00	1905,00
DD 800 H	160	80,00	2032,00
DD 850 H	170	85,00	2159,00
DD 900 H	180	90,00	2286,00
DD 1000 H	200	100,00	2540,00
DD 1100 H	220	110,00	2794,00
*DD 1120 H	224	112,00	2844,80
*DD 1140 H	228	114,00	2895,60
*DD 1150 H	230	115,00	2921,00
DD 1250 H	250	125,00	3175,00
DD 1400 H	280	140,00	3556,00
DD 1700 H	340	170,00	4318,00

Larghezze unificate / Standardised widths  
Standardbreiten / Largeurs unifiées / Anchos unificados

Codice / Code symbol Fabriknummer / Code symbole Numero de fabrica	Pollici / Inches / Zoll Pouces / Pulgadas	mm
075	3/4	19,05
100	1"	25,40
150	1 1/2"	38,10
200	2"	50,80
300	3"	76,20

## Tolleranza standard sulla larghezza delle cinghie XL-L e H

## Standard tolerance for XL-L on H belt width

## Standardtoleranz auf die Breite der XL-L und H-Riemen

## Tolérance standard sur la largeur des courroies XL-L et H

## Tolerancia estándar en el ancho de las correas XL-L y H

Larghezze delle cinghie / Belt width / Breite der Riemen Largelir des courroies / Ancho de las correas						Tolleranza sulla larghezza (mm) / Width tolerance (mm) / Breitentoleranz (mm) Tolerance sur la largeur (mm) / Tolerancia de la anchura (mm)			
Designazione / Designation Bezeichnung / Désignation Desionización		Larghezza effettiva / Effective face width Ist-breite / Largeur effective / Anchura efectiva				Sviluppo primitivo / Internal circumference / Wüzlänge Development primitif / Desarrollo inicial			
		Pollici / Inches / Zoll Pouces / Pulgadas		mm		Fino a / Up to Bis a / Jusqu'à Inferior a 33"	Oltre / Over Über / Au-dela de Superior a 33"	Fino a / Up to Bis a / Jusqu'à Inferior a 66"	Oltre / Over Über / Au-dela de Superior a 66"
Oltre / Over / Über Au-dela de Superior a	Fino a / Up to Bis a / Jusqu'à Inferior a	Oltre / Over / Über Au-dela de Superior a	Fino a / Up to Bis a / Jusqu'à Inferior a	Oltre / Over / Über Au-dela de Superior a	Fino a / Up to Bis a / Jusqu'à Inferior a				
-	<b>044</b>	-	7/16	-	11,1	+0,5	+0,4	-	-
<b>044</b>	<b>150</b>	7/16	1" 1/2	11,1	38,1	-0,8	-0,8	-	-
<b>150</b>	<b>200</b>	1" 1/2	2"	38,1	50,8	+0,8	+0,8	-	+0,8
<b>200</b>	<b>300</b>	2"	3"	50,8	76,2	-	-1,2	-	-1,3
						+0,8	±1,2	-	+1,3
						-1,3		-	-1,5
						+1,3		-	+1,5
						-1,5	±1,6	-	-2,0

La tolleranza sulla larghezza di tutte le cinghie tipo XXH è di +8 mm per qualsiasi larghezza e sviluppo.

Width tolerance for all XXH belts: +8 mm for any width or length.

Die Toleranz auf die Breite aller Riemen vom Typ XXH beträgt +8 mm für jede Art von Breite und Entwicklung.

La tolleranza sulla larghezza di tutte le cinghie tipo XXH è di +8 mm per qualsiasi larghezza e sviluppo.

La tollerancia en el ancho de todas las correas tipo XXH es de +8 mm para cualquier ancho y desarrollo.

## Tolleranza standard sullo sviluppo delle cinghie

## Standard tolerance on belt circumference

## Standardtoleranz der Riemenlänge

## Tolerance standard sur le développement des courroies

## Tolerancia estándar del desarrollo de las correas

Lunghezza cinghia in pollici / Belt length in inches Riemenlänge in Zoll / Longueur courroie en pouces Longitud correa en pulgadas		Tolleranza / Tolerance Toleranz / Tolerance Tolmerancia
Oltre / Over / Über Au-dela de / Superior a	Fino a / Up to / Bis a Jusqu'à / Inferior a	
-	10	±0,40
10	15	±0,45
15	20	±0,50
20	30	±0,60
30	40	±0,65
40	50	±0,75
50	60	±0,80
60	70	±0,85
70	80	±0,90
80	90	±0,95

Lunghezza cinghia in pollici / Belt length in inches Riemenlänge in Zoll / Longueur courroie en pouces Longitud correa en pulgadas		Tolleranza / Tolerance Toleranz / Tolerance Tolmerancia
Oltre / Over / Über Au-dela de / Superior a	Fino a / Up to / Bis a Jusqu'à / Inferior a	
90	100	±1,00
100	110	±1,05
110	120	±1,10
120	130	±1,15
130	140	±1,20
140	150	±1,25
150	160	±1,30
160	170	±1,35
170	180	±1,40

N.B.: Per tolleranze particolari chiedere offerta. Per trasmissioni ad interesse fisso interpellare i nostri tecnici.

N.B.: For special tolerances, ask for an offer. For fixed axis-to-axis transmissions, call our technicians.

N.B.: Spezialtoleranzen auf Anfrage. Für Antriebe mit festem Achsenabstand wenden Sie sich bitte an unsere technische Abteilung.

N.B.: Pour des tolérances particulières, demander une offre. Pour les transmissions à entraxe fixe, contacter nos techniciens.

NOTA: Para tolerancias especiales solicitar oferta. Para transmisiones con distancia fija entre ejes dirijase a nuestros técnicos.

## Spessore nominale misurato sul dente (mm)

## Nominal thickness measured on tooth (mm)

## Nennstärke am Zahn gemessen (mm)

## Epaisseur nominale mesurée sur la dent (mm)

## Espesor nominal medido en el diente (mm)

Tipo cinghia Belt type Riementyp Type de courroie Tipo de correa	Spessore nominale misurato sul dente (mm) / Nominal thickness measured on tooth (mm) Nennstärke am Zahn gemessen (mm) / Epaisseur nominale mesurée sur la dent (mm) / Espesor nominal medido en el diente (mm)		
	Grado di tolleranza / Degree of tolerance / Tolleranzgrad / Degre de tolerance / Grado de tolerancia		
	Grado I / Degree I / Grad I Degre I / Grado I	Grado II / Degree II / Grad II Degre II / Grado II	Cinghia standard / Standard belts Standardriemen / Courroies Standard Correas estandar
<b>XL</b>	2,3 ± 0,15	2,3 ± 0,25	2,3 ± 0,6
<b>L</b>	3,6 ± 0,15	3,6 ± 0,25	3,6 ± 0,6
<b>H</b>	4,3 ± 0,15	4,3 ± 0,25	4,3 ± 0,6
<b>XH</b>		11,2 ± 0,25	11,2 ± 0,6
<b>XXH</b>		15,7 ± 0,25	15,7 ± 0,6

• Possono lavorare normalmente a temperature tra - 25°C e + 85°C

• They operate regularly at temperatures between - 25°C and + 85°C

• Sie können bei Temperaturen von - 25°C bis + 85°C normal eingesetzt werden

• Peuvent travailler normalement à une température comprise entre - 25°C et + 85°C

• Pueden trabajar normalmente a una temperatura ambiente entre - 25°C y + 85°C

• Tollerano la presenza di olio, purché in quantità limitata

• Non devono essere sottoposte a forte piegamento od a stretto avvolgimento per non danneggiare irrimediabilmente l'inserto resistente.

• They tolerate the presence of oil providing it is in small quantities

• They must not be folded or rolled up tightly so as to damage the resistive insert beyond repair.

• Sie können geringe Mengen von Öl vertragen

• Sie dürfen nicht stark gebogen oder eng gewickelt werden, damit die Verstärkungseinlage nicht beschädigt wird.

• Tolèrent la présence d'huile en faible quantité

• Ne doivent pas être soumises à un pliage ou à un enveloppement étroit pour ne pas endommager irrémédiablement l'armature résistante.

• Toleran la presencia de aceite, en cantidades limitadas

• No deben someterse a fuerte flexión ni envolverse estrechamente, porque podría dañarse irremediabilmente el inserto de refuerzo.

**N.B.** Tutte le cinghie hanno il dorso rettificato, se in particolari applicazioni si rendesse necessario l'impiego di cinghie di spessore particolare o comunque con tolleranze diverse da quelle standard indicate, consultate i ns/ tecnici.

**N.B.** All the belts have a ground back. If in particular applications it should be necessary to use a belt of a particular thickness or anyway with tolerances that are different from the indicated standards, consult our engineers.

**N.B.** Alle Riemen haben geschliffene Rücken, Wenn für besondere Zwecke Riemen mit abweichender Stärke oder eine von den angegebenen Standardwerten abweichende Toleranzen benötigt werden, wenden Sie sich bitte an unseren technischen Kundendienst.

**N.B.** Le dos de toutes les courroies est rectifié, s'il s'avère nécessaire pour des applications particulières d'employer des courroies d'épaisseur spéciale ou de manière générale présentant des tolérances différentes de celles standard indiquées, consulter nos techniciens.

**Nota:** todas las correas tienen el dorso rectificadas; si en aplicaciones particulares se hiciera necesario utilizar correas de espesor especial, o con tolerancias distintas de los valores estándar indicados, consultar con el personal técnico de la empresa.

**Grafico per la scelta dei passo della cinghia / Graph for the choice of belt pitch**  
**Grafik für die Wahl der Riementeilung / Graphique pour le choix du pas de la courroie**  
**Gráfico para seleccionar el paso de la correa**

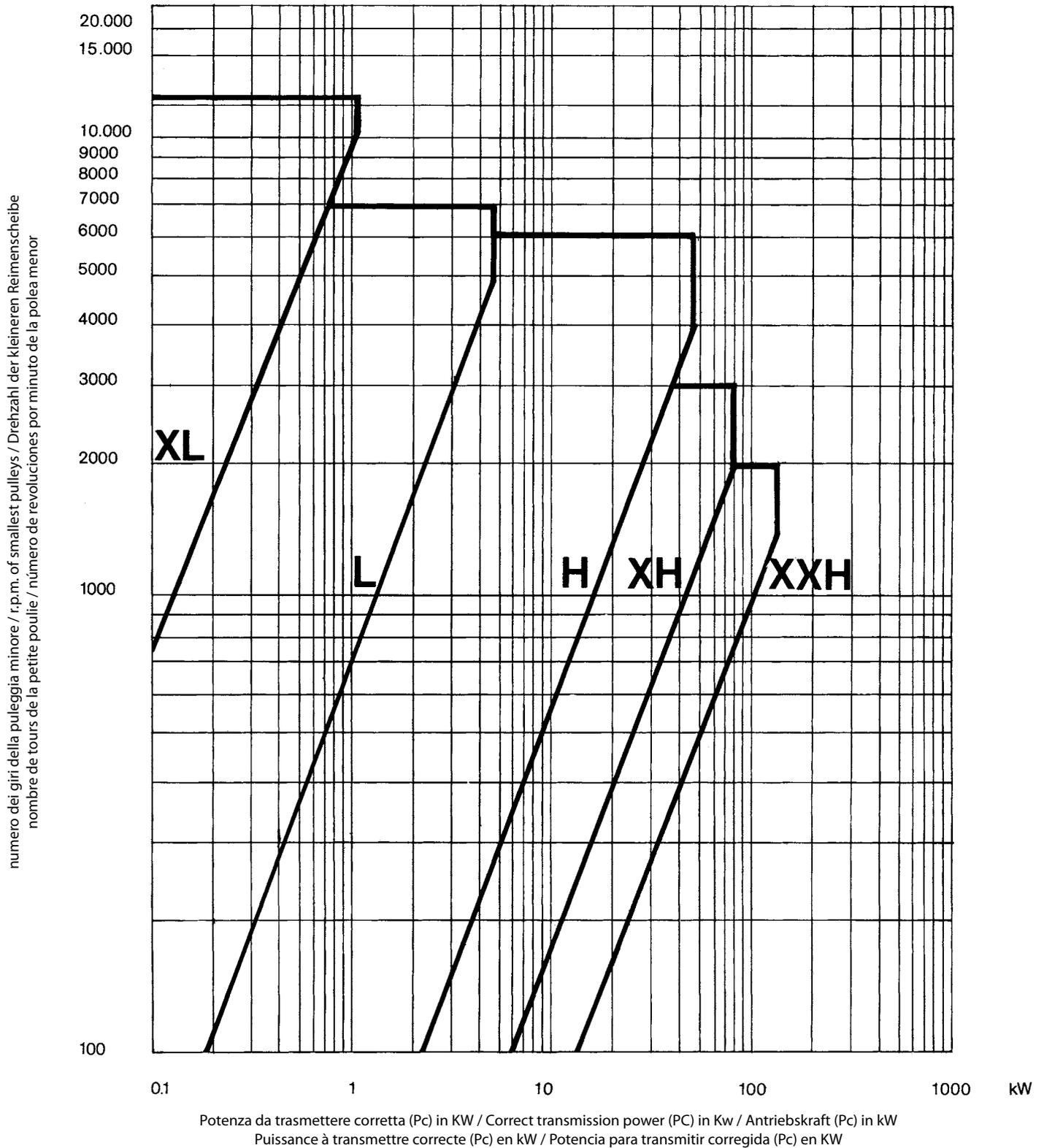

Per condizioni di esercizio non comprese nel presente grafico interpellare i nostri tecnici.

Contact our technicians for operating conditions not included in this graph.

Für Betriebsbedingungen, die nicht in dieser Grafik berücksichtigt sind, wenden Sie sich an unseren Technischen Kundendienst.

Consulter notre service technique pour des conditions d'exercice ne figurant pas dans le présent graphique.

Para condiciones de uso no comprendidas en el presente gráfico, consultar con el servicio técnico de la empresa.

# Caratteristiche costruttive delle cinghie dentate passo metrico

## Metric pitch timing belt construction characteristics

### Konstruktionsmerkmale der Zahnriemen mit metrischer Teilung

#### Caractéristiques de construction des courroies dentées pas métrique

#### Características de fabricación de las correas dentadas con paso métrico

Dal punto di vista strutturale nelle cinghie dentate si possono individuare, come indicato in figura, i seguenti elementi:

From the structural point of view the following elements can be identified in the timing belt as shown in the figure:

Bei diesen Zahnriemen werden in struktureller Hinsicht die folgenden, in Abbildung 1 gezeigten Elemente unterschieden:

Du point de vue structural, l'on distingue dans une courroie, comme indiqué sur la figure, les éléments suivants:

Desde el punto de vista estructural, en las correas dentadas se pueden distinguir los siguientes elementos (fig. 1):

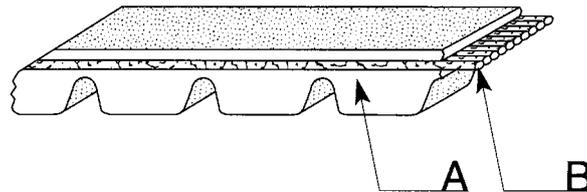

**A)** Inserto resistente  
**B)** Corpo della cinghia in poliuretano

**A)** Resistive insert  
**B)** Polyurethan body of the belt

**A)** Verstärkungseinlage  
**B)** Riemenkörper aus Polyurethan

**A)** Armature résistante  
**B)** Corps de la courroie en polyuréthane

**A)** Inserto de refuerzo  
**B)** Cuerpo de la correa en poliuretano

L'inserto resistente è l'elemento che costituisce l'anima della cinghia, sopporta interamente i carichi ed è costituito da fili di acciaio ad elevato carico di rottura. L'inserto è avvolto a spirale per tutta la larghezza della cinghia e la sua posizione determina la linea primitiva della stessa. I denti e il corpo della cinghia nel quale è annegato l'inserto resistente sono in poliuretano le cui caratteristiche sono: l'eccellente resistenza alla fatica, l'ottima resistenza al calore, la buona resistenza agli olii lubrificanti minerali e l'indeformabilità nel tempo.

The resistive insert is the element that constitutes the core of the belt. It fully bears the loads and consists of steel wires with high breaking load. The insert is wound spiral fashion the full length of the belt and its position determines the belt's pitch line. The teeth and body of the belt in which the resistive insert is sunk are made of polyurethan which has the following characteristics: Outstanding resistance to fatigue, excellent heat resistance, good resistance to mineral oil lubricants and does not deform over time

Den Kern des Riemens bildet die Verstärkungseinlage. Sie trägt die volle Last und besteht aus einern Stahiseil unit hoher zugfestigkeit. Die Verstärkungseinlage ist auf der gesamten Breite des Riemens gewickelt und ihre Lage bestimmt die wirklinie. Zähne und Körper des Riemens, in den die Verstärkungseinlage ein-gelassen ist, sind aus Polyurethan mit folgenden Eigenschaften: ausgezeichnete Erwüdungsfestigkeit, optimale Hitzebeständigkeit, resistent gegen mineralische Schmieröle und dauerhafte Formbeständigkeit.

L'armature résistante constitue l'âme de la courroie, elle supporte entièrement les charges et est composée de fils d'acier à haute charge de rupture. L'armature est enroulée en spirale sur toute la largeur de la courroie et sa position détermine la ligne primitive de celle-ci. Les dents et le corps de la courroie, dans lequel l'armature résistante est noyée, sont en polyuréthane, ce dernier présente les caractéristiques suivantes: résistance exceptionnelle à la fatigue, excellente résistance à la chaleur, bonne résistance aux huiles de lubrifications minérales et indéformabilité dans le temps.

El inserto de refuerzo constituye el alma de la correa, soporta enteramente la carga y está formado por hilos de acero con elevada carga de rotura. El inserto está envuelto en espiral en todo el ancho de la correa y su posición determina la línea primitiva de esta última. Los dientes y el cuerpo de la correa, en el cual está hundido el inserto de refuerzo, son de poliuretano con las siguientes propiedades: excepcional resistencia a la fatiga, óptima resistencia al calor, buena resistencia a los aceites lubricantes minerales e indeformabilidad a lo largo dei tiempo.

#### Caratteristiche dimensionali:

Gli elementi che contraddistinguono il tipo di cinghia sono:

- 1<sup>o</sup>) Larghezza cinghia in mm
- 2<sup>o</sup>) Passo dentatura in mm
- 3<sup>o</sup>) Lunghezza primitiva in mm

Esempio: 16T5-500

#### Dimensional characteristics:

The elements distinguishing this type of belt are:

- 1<sup>st</sup>) Belt width in mm
- 2<sup>nd</sup>) Teeth pitch
- 3<sup>rd</sup>) Pitch line length in mm

Example 16T5-600

#### Dimensions-Charakteristiken:

Die den Riementyp kennzeichnenden Elemente sind:

- 1) Riemenbreite in mm
- 2) Verzahnungsteilung in mm
- 3) Wirklänge in mm

Beispiel: 16T5-600

#### Dimensions:

Les éléments qui permettent de distinguer le type d'une courroie sont:

- 1) La larguer de la courroie en mm
- 2) Le pas de la denture en mm
- 3) La longueur primitive en mm

Exemple: 16T5-600

#### Características Dimensionales

Las características distintivas de este tipo de correa se indican de la siguiente manera:

- 1) Ancho de la correa en mm
- 2) Paso dei dentado en mm
- 3) Longitud primitiva en mm

Ejemplo: 16T5-600

**Caratteristiche costruttive delle cinghie dentate passo metrico**  
**Metric pitch timing belt construction characteristics**  
**Konstruktionsmerkmale der Zahnriemen mit metrischer Teilung**  
**Caractéristiques de construction des courroies dentées pas métrique**  
**Características de fabricación de las correas dentadas con paso métrico**

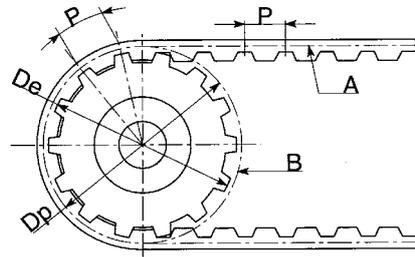

**A)** Linea primitiva della cinghia  
**B)** Circonferenza primitiva della cinghia

**A)** Belt pitch line  
**B)** Belt pitch circumference

**A)** Teilreislinie des Riemens  
**B)** Teilkreis des Riemens

**A)** Ligne primitive de la courroie  
**B)** Circonférence primitive de la courroie

**A)** Linea primitiva de la correa  
**B)** Circunferencia primitiva de la correa

**Simbologia**

**Ip** Lunghezza primitiva  
**P** Passo  
**Lc** Larghezza cinghia  
**Lp** Larghezza puleggia  
**Z** Numero dei denti  
**Dp** Diametro primitivo puleggia  
**De** Diametro esterno puleggia

**Legend**

**Ip** Pitch line length  
**P** Pitch  
**Lc** Belt width  
**Lp** Pulley width  
**Z** Number of teeth  
**Dp** Pulley pitch diameter  
**De** Outer pulley diameter

**Symbol**

**Ip** Wirklänge  
**P** Teilung  
**Lc** Riemenbreite  
**Lp** Scheibenbreite  
**Z** Zahnzahl  
**Dp** Teilkreisdurchmesser  
**De** Außendurchmesser der Scheibe

**Symboles**

**Ip** Longueur primitive  
**P** Pas  
**Lc** Largeur de la courroie  
**Lp** Largeur de la poulie  
**Z** Nombre de dents  
**Dp** Diamètre primitif de la poulie  
**De** Diamètre extérieur de la poulie

**Simbologia**

**Ip** Longitud primitiva  
**P** Paso  
**Lc** Ancho de la correa  
**Lp** Ancho de la polea  
**Z** Número de dientes  
**Dp** Diámetro primitivo polea  
**De** Diámetro externo polea

**Definizioni**

**Ip - lunghezza primitiva**  
 è lo sviluppo della cinghia misurato sulla linea primitiva che corrisponde all'asse dell'inserto resistente.

**P - passo**  
 è la distanza fra gli assi di due denti contigui siano essi quelli della puleggia o della cinghia purché misurata sulla circonferenza o sulla linea primitiva. Il passo della cinghia e il passo della puleggia debbono avere lo stesso valore. Per avere una perfetta trasmissione la linea primitiva della cinghia deve coincidere con la circonferenza primitiva della puleggia.

**Dp - diametro primitivo della puleggia**  
 Questo diametro definisce in linea teorica la posizione della circonferenza primitiva che è sempre maggiore del diametro esterno della puleggia. Il diametro primitivo può essere facilmente ricavato per mezzo della relazione  $P \cdot Z = \pi \cdot Dp$  da cui:

**Definitions**

**Ip - pitch line length**  
 is the belts' progress measured on the pitch line that corresponds to the resistive insert axis.

**P - pitch**  
 is the distance between the axes of two contiguous teeth whether of the pulley or the belt provided they are measured on the pitch line or circle. The pitch of the belt and the pitch of the pulley must have the same value. To get perfect drive, the pitch line of the belt must correspond with the pitch circle of the pulley.

**Dp - pitch diameter of the pulley**  
 This diameter theoretically defines the position of the pitch circle that is always greater than the outer diameter of the pulley. The pitch diameter can be easily obtained by means of the ratio  $P \cdot Z = \pi \cdot Dp$  therefore:

**Begriffsbestimmungen**

**Ip - Wirklänge**  
 ist die in der Achse der Verstärkungseinlage gemessene Riemenlänge.

**P - teilung**  
 ist der Abstand zwischen den Achsen zweier angrenzender Zähne der Scheibe oder des Riemens, der an der Kreislinie und an der Wirklinie gemessen wird. Riemen-teilung und Scheibenteilung müssen gleich sein. Für einen perfekten Antrieb muß die Wirklinie des Riemens mit dem Teilkreisdurchmesser der Scheibe übereinstimmen.

**Dp - Teilkreisdurchmesser der Scheibe**  
 Dieser Durchmesser definiert die logische Linie der Kreislinie, die stets größer ist als der Außendurchmesser der Scheibe. Der Teilkreisdurchmesser wird mit der folgenden Formel ermittelt  $P \cdot Z = \pi \cdot Dp$ :

**Definitions**

**Ip - longueur primitive**  
 est le développement de la courroie mesuré sur la ligne primitive qui correspond à l'axe de l'armature résistante.

**P - pas**  
 est la distance entre les axes de deux dents contiguës; ces dernières peuvent appartenir aussi bien à la poulie qu'à la courroie, à condition que l'on effectue la mesure sur la circonférence ou sur la ligne primitive. Le pas de la courroie et le pas de la poulie doivent avoir la même valeur. Pour que la transmission soit parfaite, la ligne primitive de la courroie doit coïncider avec la circonférence primitive de la poulie.

**Dp - diametre primitif de la poulie**  
 Ce diamètre défini en ligne théorique la position de la circonférence primitive qui est toujours plus grande que le diamètre extérieur de la poulie. Le diamètre primitif peut facilement être retrouvé par la relation  $P \cdot Z = \pi \cdot Dp$  d'où:

**Definiciones**

**Ip - longitud primitiva**  
 Es el desarrollo de la correa, medido sobre la línea primitiva (que corresponde al eje del inserto de refuerzo).

**P - paso**  
 Distancia entre los ejes de dos dientes adyacentes, tanto de la polea como de la correa, siempre que se mida sobre la circonferencia o sobre la línea primitiva. La correa y la polea tienen que tener el mismo paso. Para que la transmisión sea perfecta, la línea primitiva de la correa debe coincidir con la circonferencia primitiva de la polea.

**Dp - diametro primitivo de la polea**  
 Define teoricamente la posición de la circonferencia primitiva, que es siempre mayor que el diámetro externo de la polea. El diámetro primitivo se puede calcular mediante la relación  $P \cdot Z = \pi \cdot Dp$ , por lo cual:

$$Dp = \frac{P \cdot Z}{\pi}$$

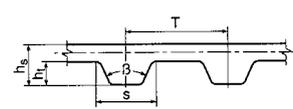
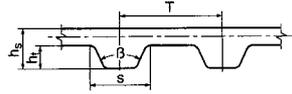
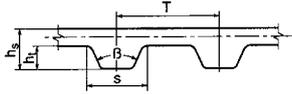

Tipo / Type Typ / Type Tipo	T (mm)	h <sub>t</sub> (mm)	h <sub>s</sub> (mm)	s (mm)	β
<b>T 2,5</b>	2,5	0,70	1,30	1,50	40°

Tipo / Type Typ / Type Tipo	T (mm)	h <sub>t</sub> (mm)	h <sub>s</sub> (mm)	s (mm)	β
<b>T 5</b>	5,0	1,20	2,20	2,65	40°

Tipo / Type Typ / Type Tipo	T (mm)	h <sub>t</sub> (mm)	h <sub>s</sub> (mm)	s (mm)	β
<b>T 10</b>	10,0	2,50	4,50	5,30	40°

### T 2,5

Passo 2,5 mm / Pitch 2,5 mm / Teilung 2,5 mm / Pas 2,5 mm / Paso 2,5 mm

### T 5

Passo 5 mm / Pitch 5 mm / Teilung 5 mm / Pas 5 mm / Paso 5 mm

### T 10

Passo 10 mm / Pitch 10 mm / Teilung 10 mm / Pas 10 mm / Paso 10 mm

### T 20

Passo 20 mm / Pitch 10 mm / Teilung 20 mm / Pas 20 mm / Paso 20 mm

Tipo Type Typ Type Tipo	Lunghezza primitiva Pitch length Teilkreislänge Longueur primitive Longitud primitiva (mm)	N. denti N. of teeth Zahnezahl N. bre de dents Cantidad de dientes
<b>T 2 5 120</b>	120,0	48
<b>T 2 5 160</b>	160,0	64
<b>T 2,5 177</b>	177,5	71
<b>T 2,5 200</b>	200,0	80
<b>T 2,5 245</b>	245,0	98
<b>T 2,5 265</b>	265,0	106
<b>T 2,5 285</b>	285,0	114
<b>T 2,5 305</b>	305,0	122
<b>T 2,5 317</b>	317,5	127
<b>T 2,5 330</b>	330,0	132
<b>T 2,5 380</b>	380,0	152
<b>T 2,5 420</b>	420,0	168
<b>T 2 5 480</b>	480,0	192
<b>T 2 5 500</b>	500,0	200
<b>T 2,5 600</b>	600,0	240
<b>T 2,5 650</b>	650,0	260
<b>T 2,5 780</b>	780,0	312
<b>T 2,5 915</b>	915,0	366
<b>T 2,5 950</b>	950,0	380

Tipo Type Typ Type Tipo	Lunghezza primitiva Pitch length Teilkreislänge Longueur primitive Longitud primitiva (mm)	N. denti N. of teeth Zahnezahl N. bre de dents Cantidad de dientes
<b>T 5 100</b>	100,0	20
<b>T 5 150</b>	150,0	30
<b>T 5 165</b>	165,0	33
<b>T 5 185</b>	185,0	37
<b>T 5 200</b>	200,0	40
<b>T 5 215</b>	215,0	43
<b>T 5 220</b>	220,0	44
<b>T 5 225</b>	225,0	45
<b>T 5 245</b>	245,0	49
<b>T 5 255</b>	255,0	51
<b>T 5 260</b>	260,0	52
<b>T 5 270</b>	270,0	54
<b>T 5 280</b>	280,0	56
<b>T 5 295</b>	295,0	59
<b>T 5 305</b>	305,0	61
<b>T 5 330</b>	330,0	66
<b>T 5 340</b>	340,0	68
<b>T 5 350</b>	350,0	70
<b>T 5 355</b>	355,0	71
<b>T 5 365</b>	365,0	73
<b>T 5 390</b>	390,0	78
<b>T 5 400</b>	400,0	80
<b>T 5 410</b>	410,0	82
<b>T 5 420</b>	420,0	84
<b>T 5 455</b>	455,0	91
<b>T 5 475</b>	475,0	95
<b>T 5 480</b>	480,0	96
<b>T 5 500</b>	500,0	100
<b>T 5 510</b>	510,0	102
<b>T 5 525</b>	525,0	105
<b>T 5 545</b>	545,0	109
<b>T 5 550</b>	550,0	110
<b>T 5 560</b>	560,0	112
<b>T 5 575</b>	575,0	115
<b>T 5 610</b>	610,0	122
<b>T 5 620</b>	620,0	124
<b>T 5 630</b>	630,0	126
<b>T 5 650</b>	650,0	130
<b>T 5 660</b>	660,0	132
<b>T 5 690</b>	690,0	138
<b>T 5 720</b>	720,0	144
<b>T 5 750</b>	750,0	150
<b>T 5 780</b>	780,0	156
<b>T 5 815</b>	815,0	163
<b>T 5 840</b>	840,0	168
<b>T 5 900</b>	900,0	180
<b>T 5 990</b>	990,0	198
<b>T 5 1075</b>	1075,0	215
<b>T 5 1100</b>	1100,0	220
<b>T 5 1215</b>	1215,0	243
<b>T 5 1380</b>	1380,0	276

Tipo Type Typ Type Tipo	Lunghezza primitiva Pitch length Teilkreislänge Longueur primitive Longitud primitiva (mm)	N. denti N. of teeth Zahnezahl N. bre de dents Cantidad de dientes
<b>T 10 260</b>	260,0	26
<b>T 10 370</b>	370,0	37
<b>T 10 400</b>	400,0	40
<b>T 10 410</b>	410,0	41
<b>T 10 440</b>	440,0	44
<b>T 10 500</b>	500,0	50
<b>T 10 530</b>	530,0	53
<b>T 10 560</b>	560,0	56
<b>T 10 600</b>	600,0	60
<b>T 10 610</b>	610,0	61
<b>T 10 630</b>	630,0	63
<b>T 10 660</b>	660,0	66
<b>T 10 690</b>	690,0	69
<b>T 10 700</b>	700,0	70
<b>T 10 720</b>	720,0	72
<b>T 10 750</b>	750,0	75
<b>T 10 780</b>	780,0	78
<b>T 10 810</b>	810,0	81
<b>T 10 840</b>	840,0	84
<b>T 10 880</b>	880,0	88
<b>T 10 890</b>	890,0	89
<b>T 10 900</b>	900,0	90
<b>T 10 920</b>	920,0	92
<b>T 10 960</b>	960,0	96
<b>T 10 970</b>	970,0	97
<b>T 10 980</b>	980,0	98
<b>T 10 1010</b>	1010,0	101
<b>T 10 1080</b>	1080,0	108
<b>T 10 1140</b>	1140,0	114
<b>T 10 1150</b>	1150,0	115
<b>T 10 1210</b>	1210,0	121
<b>T 10 1240</b>	1240,0	124
<b>T 10 1250</b>	1250,0	125
<b>T 10 1300</b>	1300,0	130
<b>T 10 1320</b>	1320,0	132
<b>T 10 1350</b>	1350,0	135
<b>T 10 1390</b>	1390,0	139
<b>T 10 1400</b>	1400,0	140
<b>T 10 1420</b>	1420,0	142
<b>T 10 1450</b>	1450,0	145
<b>T 10 1460</b>	1460,0	146
<b>T 10 1500</b>	1500,0	150
<b>T 10 1560</b>	1560,0	156
<b>T 10 1610</b>	1610,0	161
<b>T 10 1750</b>	1750,0	175
<b>T 10 1780</b>	1780,0	178
<b>T 10 1880</b>	1880,0	188
<b>T 10 1960</b>	1960,0	196
<b>T 10 2250</b>	2250,0	225
<b>T 10 3100</b>	3100,0	310
<b>T 10 4780</b>	4780,0	478

Tipo Type Typ Type Tipo	Lunghezza primitiva Pitch length Teilkreislänge Longueur primitive Longitud primitiva (mm)	N. denti N. of teeth Zahnezahl N. bre de dents Cantidad de dientes
<b>T 20 1260</b>	1260,0	63
<b>T 20 1460</b>	1460,0	73
<b>T 20 1780</b>	1780,0	89
<b>T 20 1880</b>	1880,0	94
<b>T 20 2360</b>	2360,0	118
<b>T 20 2600</b>	2600,0	130
<b>T 20 3100</b>	3100,0	155
<b>T 20 3620</b>	3620,0	181

Per gli sviluppi indicati sono forniti i relativi manicotti.

The relative sleeves can be supplied for the sizes indicated.

Für die angegebenen Längen stehen die entsprechenden Werkzeuge zur Verfügung.

Pour les développements indiqués, les manchons correspondant peuvent être fournis.

Para los desarrollos indicados se dispone de los respectivos manguitos.

Passo / Belt / Riementeilung / Pas / Paso	T 2,5 (2,5 mm)	T 5 (5 mm)	T 10 (10 mm)	T 20 (20 mm)
Larghezza delle cinghie in mm Belt width in mm Breite der Riemen in mm Largeur des courroies en mm Ancho de las correas en mm	4* 6* 10*	8* 10* 12* 16* 25*	12* 16* 25* 32* 50*	32 50 75 100

Larghezza cinghia di normale scorta a magazzino.

Width of belt normally in stock.

Breite Ersatzriemen am Lager.

Largeur courroie habituellement en stock.

Anchura de la correa normalmente en existencia en el almacén.



**Cinghie dentate passo metrico a doppia dentatura / Double toothed timing belts**  
**Zahnriemen in metrischer Teilung mit beidseitiger verzahnung**  
**Courroies dentées a double denture / Correa dentadas con doble dentado**



**T 5**

Passo 5 mm / Pitch 5 mm / Teilung 5 mm / Pas 5 mm / Paso 5 mm

Tipo / Type Typ / Type Tipo	Lunghezza primitiva Pitch length / Teilkreislänge Longueur primitive / Longitud primitiva (mm)	N. denti N. of teeth / Zahnezahl N. bre de dents Cantidad de dientes
<b>410 T 5 DL</b>	410,0	82
<b>460 T 5 DL</b>	460,0	92
<b>590 T 5 DL</b>	590,0	118
<b>620 T 5 DL</b>	620,0	124
<b>750 T 5 DL</b>	750,0	150
<b>815 T 5 DL</b>	815,0	163
<b>860 T 5 DL</b>	860,0	172
<b>940 T 5 DL</b>	940,0	188
<b>1100 T 5 DL</b>	1100,0	220

**T 10**

Passo 10 mm / Pitch 10 mm / Teilung 10 mm / Pas 10 mm / Paso 10 mm

Tipo / Type Typ / Type Tipo	Lunghezza primitiva Pitch length / Teilkreislänge Longueur primitive / Longitud primitiva (mm)	N. denti N. of teeth / Zahnezahl N. bre de dents Cantidad de dientes
<b>260 T 10 DL</b>	260,0	26
<b>530 T 10 DL</b>	530,0	53
<b>630 T 10 DL</b>	630,0	63
<b>660 T 10 DL</b>	660,0	66
<b>720 T 10 DL</b>	720,0	72
<b>840 T 10 DL</b>	840,0	84
<b>980 T 10 DL</b>	980,0	98
<b>1210 T 10 DL</b>	1210,0	121
<b>1240 T 10 DL</b>	1240,0	124
<b>1250 T 10 DL</b>	1250,0	125
<b>1320 T 10 DL</b>	1320,0	132
<b>1350 T 10 DL</b>	1350,0	135
<b>1410 T 10 DL</b>	1410,0	141
<b>1420 T 10 DL</b>	1420,0	142
<b>1610 T 10 DL</b>	1610,0	161
<b>1880 T 10 DL</b>	1880,0	188

Tolleranza di taglio sulla larghezza cinghia a norme Din 7721. Cutting tolerance on belt width according to DIN 7721. Schnitttoleranzen an der Riemenbreite gemäß DIN 7721. Tolérance de coupe largeur courroie aux normes DIN 7721. Tolerancia de corte sobre el ancho de la correa según normas Din 7721.

Passo cinghia / Belt pitch Riementeilung / Pas de la courroie / Paso de la correa	Larghezza cinghia / Belt width Riemenbreite / Largeur de la courroie / Anchura de la correa (mm)	Tolleranza sulla larghezza / Width tolerance Breitentoleranz / Tolerance sur la largeur Tolerancia de la anchura
<b>T 2,5</b>	4	± 0,3
	6	
	10	
<b>T 5</b>	8	± 0,5
	10	
	12	
	16	
	25	
<b>T 10</b>	12	± 0,5
	16	
	25	
	32	
	50	
<b>T 20</b>	32	± 1,0
	50	
	75	
	100	

Tolleranza di sviluppo cinghia rapportata all'interesse. Belt length tolerance rationed with the distance between centres. Toleranz der Riemen lange entwicklung im Verhältnis zum Achsabstand. Tolérance de développement courroie rapportée à l'entraxe. Tolerancia de desarrollo de la correa con relación a la distancia entre ejes.

Lunghezza primitiva nom. cinghia Rated belt pitch length Nennlänge des Riementeilkreises Longueur primitive nominale courroie Longitud primitiva nominal correa (mm)	Variatione di interasse Center distance variations Achsabstandänderungen Variations d'entraxe Variaciones de la distancia entre ejes	Lunghezza primitiva nom. cinghia Rated belt pitch length Nennlänge des Riementeilkreises Longueur primitive nominale courroie Longitud primitiva nominal correa (mm)	Variatione di interasse Center distance variations Achsabstandänderungen Variations d'entraxe Variaciones de la distancia entre ejes
< 152	± 0,18	762,1 ÷ 991	± 0,33
152,1 ÷ 254	± 0,21	991,1 ÷ 1219	± 0,38
254,1 ÷ 381	± 0,23	1219,1 ÷ 1524	± 0,41
381,1 ÷ 508	± 0,26	1524,1 ÷ 1778	± 0,43
508,1 ÷ 762	± 0,31	1778 <	± 0,46

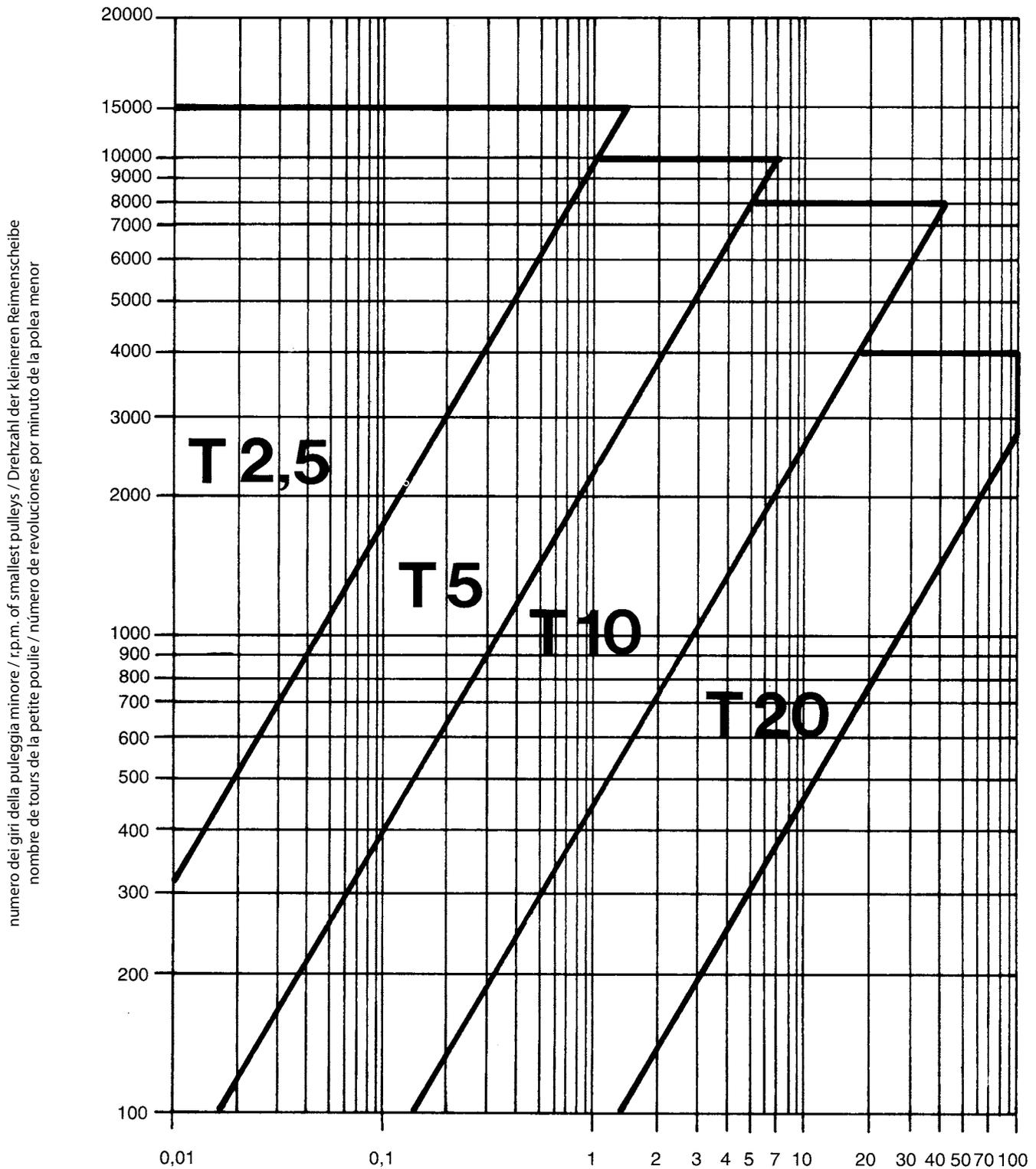

Potenza da trasmettere corretta (Pc) in KW / Correct transmission power (PC) in Kw / Antriebskraft (Pc) in kW  
 Puissance à transmettre correcte (Pc) en kW / Potencia para transmitir corregida (Pc) en KW

Per condizioni di esercizio non comprese nel presente grafico interpellare i nostri tecnici.

Contact our technicians for operating conditions not included in this graph.

Für Betriebsbedingungen, die nicht in dieser Grafik berücksichtigt sind, wenden Sie sich an unseren Technischen Kundendienst.

Consulter notre service technique pour des conditions d'exercice ne figurant pas dans le présent graphique.

Para condiciones de uso no comprendidas en el presente gráfico, consultar con el servicio técnico de la empresa.

**Cinghie dentate in poliuretano passo metrico "AT"**  
**"AT" metric pitch polyurathane timing Belts**  
**Zahnriemen aus polyurethan metrische teilung "AT"**  
**Courroies dentees en polyurethane pas metrique "AT"**  
**Correas dentadas en poliuretano con paso metrico "AT"**

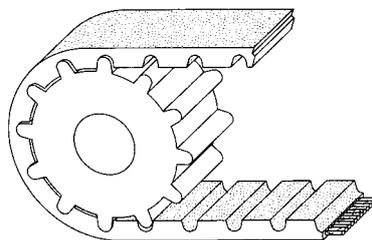

**Caratteristiche dimensionali**

- P** Passo
- Z** Numero dei denti
- ø p** Diametro primitivo puleggia
- ø e** Diametro esterno puleggia
- Lp** Larghezza puleggia
- Lc** Larghezza cinghia
- Lpc** Lunghezza primitiva cinghia

**Dimensional features**

- P** Pitch
- Z** Number of teeth
- ø p** Pulley pitch diameter
- ø e** Pulley outside diameter
- Lp** Pulley width
- Lc** Belt width
- Lpc** Belt pitch line length

**Dimensions charakteristiken**

- P** Teilung
- Z** Zähnezahl
- ø p** Teilkreisdurchmesser Scheibe
- ø e** Außendurchmesser der Scheibe
- Lp** Scheibenbreite
- Lc** Riemenbreite
- Lpc** Wirklänge Riemen

**Dimensions**

- P** Pas
- Z** Nombre de dents
- ø p** Diamètre primitif de la poulie
- ø e** Diamètre extérieur de la poulie
- Lp** Largeur de la poulie
- Lc** Largeur de la courroie
- Lpc** Longueur primitive de la courroie

**Características dimensionales**

- P** Paso
- Z** Número de dientes
- ø p** Diámetro primitivo polea
- ø e** Diámetro externo polea
- Lp** Ancho de la polea
- Lc** Ancho de la correa
- Lpc** Longitud primitiva correa

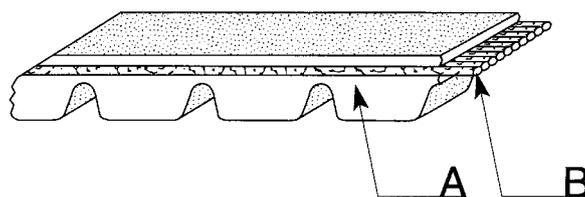
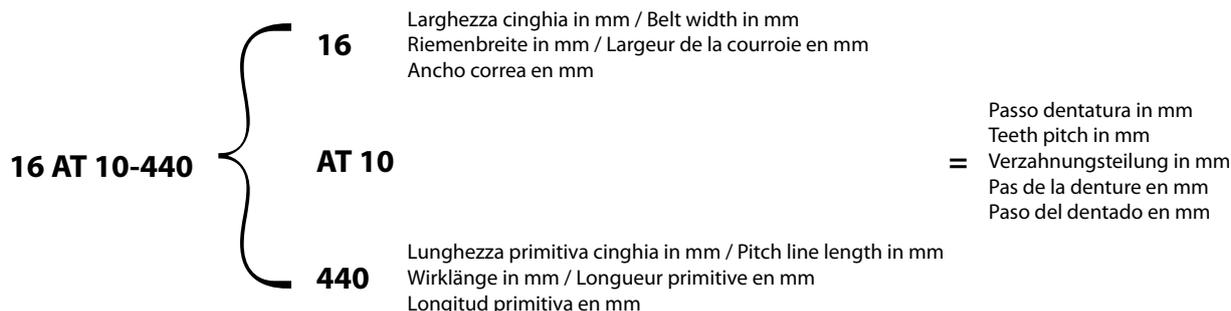

- A)** Corpo della cinghia in poliuretano
- B)** Inserto resistente in acciaio

- A)** Polyurethane belt body
- B)** Steel resistive insert

- A)** Riemenkörper aus Polyurethan
- B)** Verstärkungseiniage aus Stahl

- A)** Corps de la courroie en polyuréthane
- B)** Armature résistance en acier

- A)** Cuerpo de la correa en poliuretano
- B)** Inserto de refuerzo en acero

**N.B.** Il profilo "AT" è un'ottimizzazione del passo metrico T, permette un ingranamento migliore della cinghia con conseguente minore rumorosità, potenza trasmissibile maggiore ~ 30% rispetto al tipo T.  
 Campi d'impiego: macchine utensili, elettrodomestici, macchine tessili, macchine per l'imballaggio, macchine per scrivere e calcolatrici, macchine per cucire, ecc.

**N.B.** The "AT" profile is an enhancement of metric pitch T: it permits a better mesh of the belt with consequently lower noise levels, approx. ~ 30% more power can be transmitted compared with type T.  
 Range of use: machine tools, electric appliances, textile machines, packaging machines, typewriters, calculators, sewing machines etc.

**N.B.** Das Profil "AT" ist eine Optimierung der metrischen Teilung T und ermöglicht den besseren Eingriff des Riemens und folglich geringere Geräuschen-twicklung, sowie eine größere übertragbare Kraft ~ 30% im Vergleich zum Typ T.  
 Anwendungsbereiche: Werkzeugmaschinen, Haus-haltsgeräte, Textil-maschinen, Verpackun-gsmaschinen, Schreib- und Rechenmaschi-nen, Nähma-schinen, usw.

**N.B.** Le profil "AT" est une version améliorée du pas métrique T, il permet un meilleur engrenage de la courroie, une diminution du bruit, une plus grande puissance transmissible ~ 30% par rapport au type T.  
 Domaines d'application: machines-outils, électro-mé-nagers, machines textiles, machines d'emballage, machines à écrire et calculatrices, machines à coudre, etc...

**Nota** El perfil "AT" es una optimización del paso métrico T y permite que la correa se engrane mejor, el funcionamiento sea menos ruidoso y la potencia transmisibile sea mayor ~ 30% más que el tipo T.  
 Campos de aplicación: máquinas herramientas, electro-domésticos, máquinas texti-les, de embalar, de escribir, de coser, calculadoras, etc.

**Cinghie dentate in poliuretano passo metrico "AT"**  
**"AT" metric pitch polyurathane timing Belts**  
**Zahnriemen aus Polyurethan metrische Teilung "AT"**  
**Courroies dentees en polyurethane pas metrique "AT"**  
**Correas dentadas en poliuretano con paso metrico "AT"**

### AT 5

Passo 5 mm / Pitch 5 mm / Teilung 5 mm / Pas 5 mm / Paso 5 mm

Tipo di cinghia Belt type Riementyp Type de courroie Tipo de correa	Lunghezza primitiva Pitch length / Teilkreislänge Longueur primitive / Longitud primitiva (mm)	N. denti N. of teeth / Zahnezahl N. bre de dents Cantidad de dientes
AT5 225	225	45
AT5 255	255	51
AT5 280	280	56
AT5 300	300	60
AT5 390	390	78
AT5 420	420	84
AT5 455	455	91
AT5 500	500	100
AT5 545	545	109
AT5 610	610	122
AT5 660	660	132
AT5 720	720	144
AT5 750	750	150
AT5 780	780	156
AT5 825	825	165
AT5 975	975	195
AT5 1050	1050	210
AT5 1125	1125	225
AT5 1500	1500	300

### AT 10

Passo 10 mm / Pitch 10 mm / Teilung 10 mm / Pas 10 mm / Paso 10 mm

Tipo di cinghia Belt type Riementyp Type de courroie Tipo de correa	Lunghezza primitiva Pitch length / Teilkreislänge Longueur primitive / Longitud primitiva (mm)	N. denti N. of teeth / Zahnezahl N. bre de dents Cantidad de dientes
AT10 500	500	50
AT10 560	560	56
AT10 610	610	61
AT10 660	660	66
AT10 700	700	70
AT10 720	720	72
AT10 780	780	78
AT10 800	800	80
AT10 840	840	84
AT10 890	890	89
AT10 960	960	96
AT10 980	980	98
AT10 1050	1050	105
AT10 1080	1080	108
AT10 1150	1150	115
AT10 1210	1210	121
AT10 1250	1250	125
AT10 1320	1320	132
AT10 1400	1400	140
AT10 1500	1500	150
AT10 1600	1600	160
AT10 1700	1700	170
AT10 1800	1800	180

**Poliuretano con trefolo in acciaio / Polyurethane with steel strand**  
**Polyurethan mit Stahlitze / Polyuréthane avec torn / Poliuretano con trenza de acero**

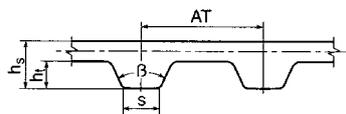

Tipo / Type / Typ / Type / Tipo	AT (mm)	h <sub>t</sub> (mm)	h <sub>s</sub> (mm)	s (mm)	β
<b>T 5</b>	5	1,2	2,7	2,5	50°

Tipo / Type / Typ / Type / Tipo	T (mm)	h <sub>t</sub> (mm)	h <sub>s</sub> (mm)	s (mm)	β
<b>AT 10</b>	10	2,5	4,5	5	50°

Larghezze standard delle cinghie e tolleranze di taglio. Standard belt width and cutting tolerance. Standard- Riemenlänge und Schnitttoleranz. Largeur standard des courroies et tolérance de coupe. Ancho estándar de la correa y tolerancia de corte.

Passo cinghia / Belt pitch Riementeilung / Pas de la courroie / Paso de la correa	Larghezza cinghia / Belt width Riemenbreite / Largeur de la courroie / Anchura de la correa (mm)	Tolleranza sulla larghezza / Width tolerance Breitentoleranz / Tolerance sur la largeur Tolerancia de la anchura
<b>AT 5 (5 mm)</b>	10	± 0,5
	16	
	25	
<b>AT 10 (10 mm)</b>	16	± 0,5
	25	
	32	
	50	

**Scelta del passo della cinghia / Selection of belt pitch**  
**Wahl der Riementeilung / Choix du pas de la courroie**  
**Selección del paso de la correa**

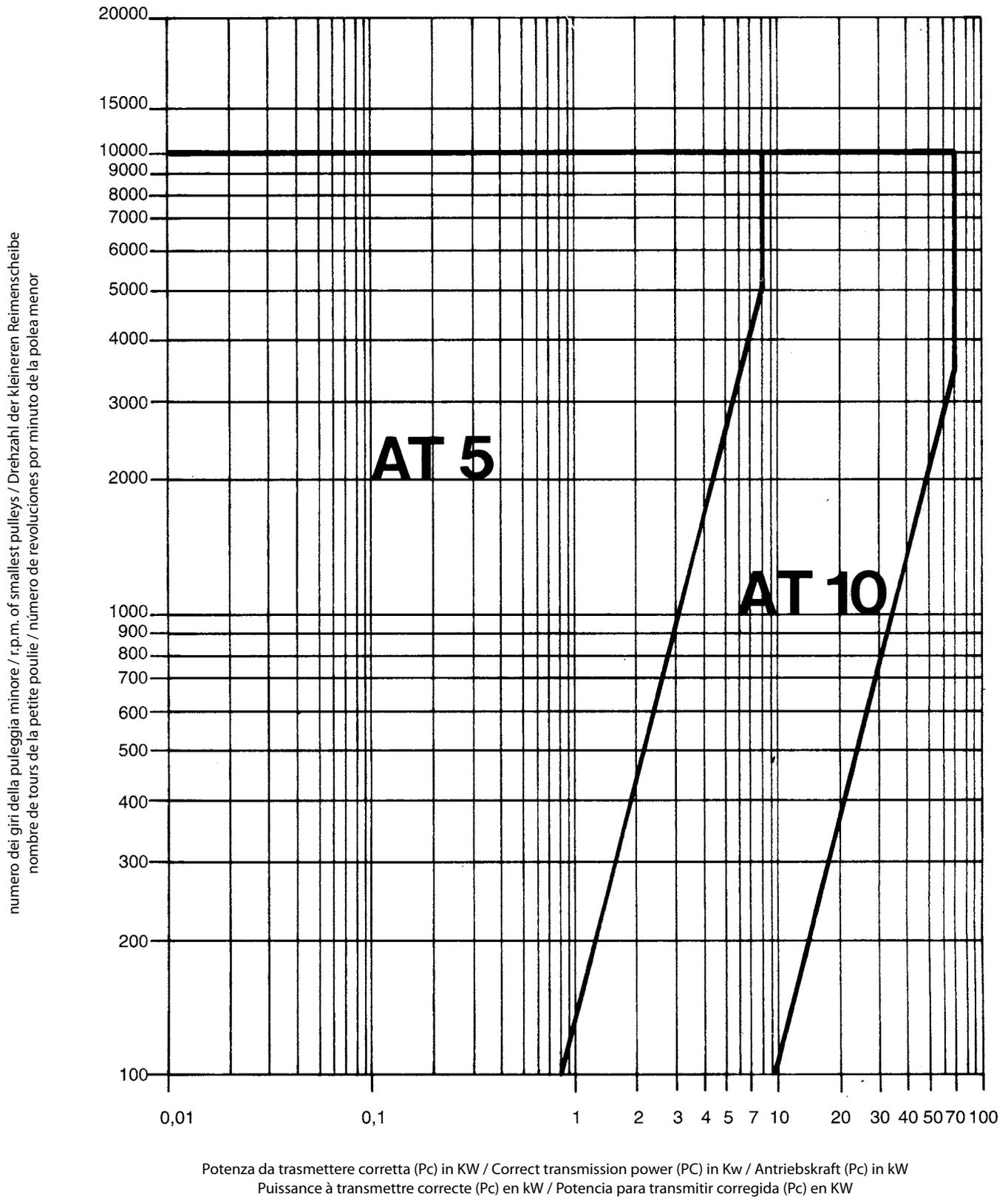

Per condizioni di esercizio non comprese nel presente grafico interpellare i nostri tecnici.

Contact our technicians for operating conditions not included in this graph.

Für Betriebsbedingungen, die nicht in dieser Grafik berücksichtigt sind, wenden Sie sich an unseren Technischen Kundendienst.

Consulter notre service technique pour des conditions d'exercice ne figurant pas dans le présent graphique.

Para condiciones de uso no comprendidas en el presente gráfico, consultar con el servicio técnico de la empresa.

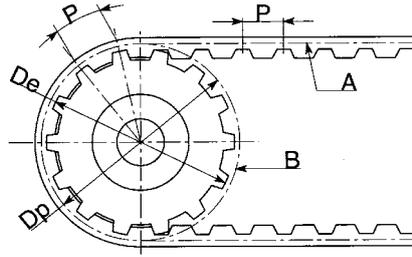

- |  |                             |                              |   |
|--|-----------------------------|------------------------------|---|
| A) Linea primitiva della cinghia         | A) Belt pitch line          | A) Teilreislinie des Riemens | A) Ligne primitive de la courroie         |
| B) Circonferenza primitiva della cinghia | B) Belt pitch circumference | B) Teilkreis des Riemens     | B) Circonférence primitive de la courroie |

### Simbologia

- P** Passo  
**Dp** Diametro primitivo  
**De** Diametro esterno

### Legend

- P** Pitch  
**Dp** Pitch diameter  
**De** Outer diameter

### Symbol

- P** Teilung  
**Dp** Teilkreisdurchmesser  
**De** Außendurchmesser

### Symboles

- P** Pas  
**Dp** Diamètre primitif  
**De** Diamètre extérieur

### Simbologia

- P** Paso  
**Dp** Diámetro primitivo  
**De** Diámetro externo

### Specifiche per le cinghie

Le cinghie dentate HTD® vengono costruite nei seguenti passi:

3 mm, 5 mm, 8 mm, 14 mm e 20 mm e in una vasta gamma di lunghezze e larghezze.

Le dimensioni principali di una cinghia sono:

#### Lunghezza primitiva

#### Passo

#### Larghezza

La lunghezza primitiva della cinghia corrisponde al prodotto del passo per il N. di denti della cinghia stessa.

Il passo della cinghia è dato dalla distanza, in mm, tra i centri di due denti adiacenti, misurati sulla linea primitiva della cinghia.

La linea primitiva teorica d'una cinghia HTD® è situata nell'interno dei cavetti resistenti.

### Belt specifications

HTD® timing belts are made with the following pitches 3 mm, 5 mm, 8 mm, 14 mm and 20 mm and in a wide range of lengths and widths.

The main dimensions of a belt are:

#### Pitch line length

#### Pitch

#### Width

The pitch line length equals the product of the pitch times the number of belt teeth.

The belt pitch is given by the distance, in mm, between the centres of two adjacent teeth measured on the belt's pitch line.

The theoretical pitch line of an HTD® belt is situated inside the tensile wires.

### Riemen-Spezifikationen

Die Zahnriemen HTD® werden mit den folgenden Teilungen konstruiert:

3 mm, 5 mm, 14 mm und 20 mm, sowie in vielen Längen und Breiten.

Die hauptsächlichsten Abmessungen eines Riemens sind:

#### Wirklänge

#### Teilung

#### Breite

Die Wirklänge eines Riemens entspricht dem Ergebnis aus Teilung mal Zähnezahl.

Die Riementeilung ergibt sich aus dem Abstand in mm zwischen den Mittelpunkten zweier anliegender Zähne, der auf der Wirklinie des Riemens gemessen wird.

Die theoretische Wirklinie eines Riemens HTD® befindet sich im Innern der Verstärkungseinlagen.

### Spécificités des courroies

Les courroies dentées HTD® sont fabriquées dans les pas suivants:

3 mm, 5 mm, 8 mm, 14 mm et 20 mm et dans une vaste gamme de longueurs et de largeurs.

Les principales dimensions d'une courroie sont:

#### La longueur primitive

#### Le pas

#### La largeur

La longueur primitive de la courroie correspond au produit du pas par le nombre de dents de la courroie elle-même.

Le pas de la courroie est donné par la distance, en mm, entre les centres de deux dents adjacentes, mesurée sur la ligne primitive de la courroie.

La ligne primitive théorique d'une courroie HTD® est située à l'intérieur des cordons de renforcement.

### Especificaciones para las correas

Las correas dentadas HTD® se fabrican con los siguientes pasos:

3 mm, 5 mm, 8 mm, 14 mm y 20 mm, en una vasta gama de longitudes y anchos.

Las dimensiones principales de una correa son:

#### Longitud primitiva

#### Paso

#### Ancho

La longitud primitiva de la correa equivale al producto del paso por el número de dientes.

El paso de la correa está dado por la distancia en milímetros entre los centros de dos dientes adyacentes, medida sobre la línea primitiva.

La línea primitiva teórica de una correa HTD® está situada dentro de los cordones de refuerzo.

### Codice di identificazione di una cinghia

### Belt identification code

### Identifizierungs-Code eines Riemens

### Code d'identification d'une courroie

### Código de identificación de una correa

Esempio / Example / Beispiel / Exemple / Ejemplo:

Sviluppo primitivo / Pitch length  
Wirklänge / Développement primitif  
Desarrollo primitivo

Passo in mm  
Pitch in mm  
Teilung in mm  
Pas en mm  
Paso en mm

**1120 - 8M - 85**

Larghezza cinghia / Belt width  
Riemenbreite / Largeur de la courroie  
Ancho correa

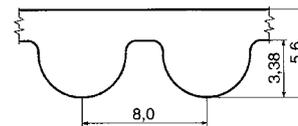

### HTD® 8M

Tipo **8M** (valori medi - mm)

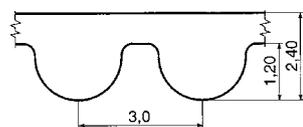

### HTD® 3M

Tipo **3M** (valori medi - mm)

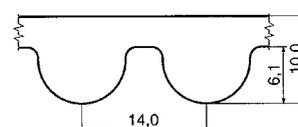

### HTD® 14M

Tipo **14M** (valori medi - mm)

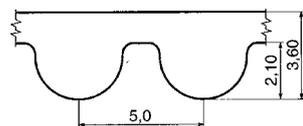

### HTD® 5M

Tipo **5M** (valori medi - mm)

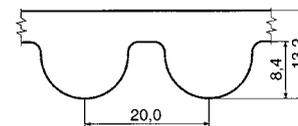

### HTD® 20M

Tipo **14M** (valori medi - mm)

### HTD® 3M

Passo 3 mm / Pitch 3 mm / Teilung 3 mm  
 Pas 3 mm / Paso 3 mm

Tipo di cinghia Belt type Riementyp Type de courroie Tipo de correa	N. denti N. of teeth Zahnezahl N. bre de dents Cantidad de dientes	Lunghezza primitiva Pitch length Teilkreislänge Longueur primitive Longitud primitiva (mm)
<b>129 3M</b>	43	129
<b>144 3M</b>	48	144
<b>147 3M</b>	49	147
<b>150 3M</b>	50	150
<b>159 3M</b>	53	159
<b>168 3M</b>	56	168
<b>174 3M</b>	58	174
<b>177 3M</b>	59	177
<b>180 3M</b>	60	180
<b>186 3M</b>	62	186
<b>195 3M</b>	65	195
<b>201 3M</b>	67	201
<b>204 3M</b>	68	204
<b>207 3M</b>	69	207
<b>210 3M</b>	70	210
<b>213 3M</b>	71	213
<b>225 3M</b>	75	225
<b>252 3M</b>	84	252
<b>255 3M</b>	85	255
<b>267 3M</b>	89	267
<b>276 3M</b>	92	276
<b>285 3M</b>	95	285
<b>288 3M</b>	96	288
<b>291 3M</b>	97	291
<b>297 3M</b>	99	297
<b>300 3M</b>	100	300
<b>312 3M</b>	104	312
<b>318 3M</b>	106	318
<b>333 3M</b>	111	333
<b>339 3M</b>	113	339
<b>345 3M</b>	115	345
<b>357 3M</b>	119	357
<b>363 3M</b>	121	363
<b>384 3M</b>	128	384
<b>390 3M</b>	130	390
<b>420 3M</b>	140	420
<b>447 3M</b>	149	447
<b>474 3M</b>	158	474
<b>480 3M</b>	160	480
<b>486 3M</b>	162	486
<b>489 3M</b>	163	489
<b>501 3M</b>	167	501
<b>513 3M</b>	171	513
<b>531 3M</b>	177	531
<b>564 3M</b>	188	564
<b>576 3M</b>	192	576
<b>597 3M</b>	199	597
<b>600 3M</b>	200	600
<b>633 3M</b>	211	633
<b>669 3M</b>	223	669
<b>711 3M</b>	237	711
<b>804 3M</b>	268	804
<b>882 3M</b>	294	882
<b>945 3M</b>	315	945
<b>1062 3M</b>	354	1062
<b>1125 3M</b>	375	1125
<b>1245 3M</b>	415	1245
<b>1263 3M</b>	421	1263
<b>1500 3M</b>	500	1500
<b>1530 3M</b>	510	1530
<b>1863 3M</b>	621	1863

### HTD® 5M

Passo 5 mm / Pitch 5 mm / Teilung 5 mm  
 Pas 5 mm / Paso 5 mm

Tipo di cinghia Belt type Riementyp Type de courroie Tipo de correa	N. denti N. of teeth Zahnezahl N. bre de dents Cantidad de dientes	Lunghezza primitiva Pitch length Teilkreislänge Longueur primitive Longitud primitiva (mm)
<b>225 5M</b>	45	225
<b>255 5M</b>	51	255
<b>280 5M</b>	56	280
<b>300 5M</b>	60	300
<b>305 5M</b>	61	305
<b>325 5M</b>	65	325
<b>330 5M</b>	66	330
<b>340 5M</b>	68	340
<b>350 5M</b>	70	350
<b>360 5M</b>	72	360
<b>370 5M</b>	74	370
<b>375 5M</b>	75	375
<b>400 5M</b>	80	400
<b>425 5M</b>	85	425
<b>450 5M</b>	90	450
<b>475 5M</b>	95	475
<b>500 5M</b>	100	500
<b>525 5M</b>	105	525
<b>535 5M</b>	107	535
<b>550 5M</b>	110	550
<b>565 5M</b>	113	565
<b>575 5M</b>	115	575
<b>580 5M</b>	116	580
<b>600 5M</b>	120	600
<b>615 5M</b>	123	615
<b>635 5M</b>	127	635
<b>645 5M</b>	129	645
<b>665 5M</b>	133	665
<b>670 5M</b>	134	670
<b>700 5M</b>	140	700
<b>710 5M</b>	142	710
<b>740 5M</b>	148	740
<b>750 5M</b>	150	750
<b>800 5M</b>	160	800
<b>835 5M</b>	167	835
<b>860 5M</b>	172	860
<b>890 5M</b>	178	890
<b>900 5M</b>	180	900
<b>925 5M</b>	185	925
<b>950 5M</b>	190	950
<b>980 5M</b>	196	980
<b>1000 5M</b>	200	1000
<b>1050 5M</b>	210	1050
<b>1125 5M</b>	225	1125
<b>1175 5M</b>	235	1175
<b>1270 5M</b>	254	1270
<b>1350 5M</b>	270	1350
<b>1420 5M</b>	284	1420
<b>1595 5M</b>	319	1595
<b>1790 5M</b>	358	1790
<b>1800 5M</b>	360	1800
<b>1870 5M</b>	374	1870
<b>1895 5M</b>	379	1895
<b>2000 5M</b>	400	2000
<b>2525 5M</b>	505	2525

### HTD® 8M

Passo 8 mm / Pitch 8 mm / Teilung 8 mm  
 Pas 8 mm / Paso 8 mm

Tipo di cinghia Belt type Riementyp Type de courroie Tipo de correa	N. denti N. of teeth Zahnezahl N. bre de dents Cantidad de dientes	Lunghezza primitiva Pitch length Teilkreislänge Longueur primitive Longitud primitiva (mm)
<b>480 8M</b>	60	480
<b>560 8M</b>	70	560
<b>600 8M</b>	75	600
<b>640 8M</b>	80	640
<b>720 8M</b>	90	720
<b>800 8M</b>	100	800
<b>880 8M</b>	110	880
<b>960 8M</b>	120	960
<b>1040 8M</b>	130	1040
<b>1120 8M</b>	140	1120
<b>1200 8M</b>	150	1200
<b>1280 8M</b>	160	1280
<b>1440 8M</b>	180	1440
<b>1600 8M</b>	200	1600
<b>1760 8M</b>	220	1760
<b>1800 8M</b>	225	1800
<b>2000 8M</b>	250	2000
<b>2400 8M</b>	300	2400
<b>2600 8M</b>	325	2600
<b>2800 8M</b>	350	2800

### HTD® 14M

Passo 14 mm / Pitch 14 mm / Teilung 14 mm  
 Pas 14 mm / Paso 14 mm

Tipo di cinghia Belt type Riementyp Type de courroie Tipo de correa	N. denti N. of teeth Zahnezahl N. bre de dents Cantidad de dientes	Lunghezza primitiva Pitch length Teilkreislänge Longueur primitive Longitud primitiva (mm)
<b>966 14M</b>	69	966
<b>1190 14M</b>	85	1190
<b>1400 14M</b>	100	1400
<b>1610 14M</b>	115	1610
<b>1778 14M</b>	127	1778
<b>1890 14M</b>	135	1890
<b>2100 14M</b>	150	2100
<b>2310 14M</b>	165	2310
<b>2450 14M</b>	175	2450
<b>2590 14M</b>	185	2590
<b>2800 14M</b>	200	2800
<b>3150 14M</b>	225	3150
<b>3500 14M</b>	250	3500
<b>3850 14M</b>	275	3850
<b>4326 14M</b>	309	4326
<b>4578 14M</b>	327	4578

### HTD® 20M

Passo 20 mm / Pitch 20 mm / Teilung 20 mm  
 Pas 20 mm / Paso 20 mm

Tipo di cinghia Belt type Riementyp Type de courroie Tipo de correa	N. denti N. of teeth Zahnezahl N. bre de dents Cantidad de dientes	Lunghezza primitiva Pitch length Teilkreislänge Longueur primitive Longitud primitiva (mm)
<b>2000 20M</b>	100	2000
<b>3400 20M</b>	170	3400
<b>4200 20M</b>	210	4200
<b>5000 20M</b>	250	5000
<b>5400 20M</b>	270	5400
<b>5800 20M</b>	290	5800
<b>6200 20M</b>	310	6200
<b>6600 20M</b>	330	6600

Sono tenute in stock le cinghie 3M - 5M - 8M e 14M. Per le cinghie passo 20M vogliate consultare i nostri Uffici commerciali.

Belt 3M-5M-8M and 14M are stock items. For 20M pitch belts, please consult our sales office.

Wir haben die Riemen vom Typ 3M-5M-8M und 14M auf Lager. Für die Riemen vom Typ 20M wenden Sie sich bitte an unsere Verkaufsabteilung.

Les courroies 3M-5M-8M et 14M sont présentes en stock. Pour les courroies pas 20M, veuillez contacter nos bureaux commerciaux.

Son mantenidas en almacén las correas 3M, 5M, 8M y 14M. Para las correas con paso 20M, consulte por favor a nuestra Oficina Comercial.

Passo / Belt / Riementeilung / Pas / Paso	HTD® 3M	HTD® 5M	HTD® 8M	HTD® 14M	HTD® 20M
Larghezza delle cinghie in mm Belt width in mm Breite der Riemen in mm Largeur des courroies en mm Ancho de las correas en mm	6* 9* 15*	9* 15* 25*	20* 30* 50* 85*	40* 55* 85* 115* 170*	115 170 230 290 340

Larghezza cinghia di normale scorta a magazzino.

Width of belt normally in stock.

Breite Ersatzriemen am Lager.

Largeur courroie habituellement en stock.

Anchura de la correa normalmente en existencia en el almacén.

### Tolleranze di costruzione delle cinghie

Pur avendo sullo sviluppo primitivo della cinghia tolleranze costruttive molto contenute, si dovrà in fase di montaggio, tenere conto di ciò prevedendo o la possibilità di variare l'interasse per avere una buona tensione della cinghia o la possibilità di tensionare la trasmissione per mezzo di un rullo tenditore. Quest'ultimo però non dovrà mai avere un diametro inferiore a quello della puleggia minore.

### Belt construction tolerances

While there are very low tolerance levels in the construction of the belt's pitch line length, at the fitting stage make allowances for this taking into account either the possibility of varying the distances between centres so the belt is tensioned well or the possibility of tensioning the transmission by means of a tension roller.

The tensioning roller must never have a smaller diameter than the diameter of the smaller pulley.

### Konstruktions-Toleranzen der Riemen

Obwohl an der Wirklänge des Riemens sehr geringe Konstruktions-toleranzen vorhanden sind, müssen diese während der Montagephase berücksichtigt werden, indem die eventuelle Änderung des Achsenabstands vorgesehen wird, um eine gute Riemenspannung die Möglichkeit zu erhalten.

Letztere darf jedoch auf keinen Fall einen kleineren Durchmesser als jener der kleinen Scheibe haben.

### Tolérances de construction des courroies

Les tolérances de construction relatives au développement primitif de la courroie étant tout de même très limitées, il faudra, en phase de montage, tenir compte de cela et prévoir soit la possibilité de faire varier l'entraxe pour avoir une bonne tension de la courroie, soit la possibilité de tendre la transmission au moyen d'un rouleau tendeur.

Ce dernier toutefois ne devra jamais avoir un diamètre inférieur à celui de la petite poulie.

### Tolerancia en la distancia entre ejes

Aunque en el desarrollo primitivo de la correa las tolerancias de fabricación son muy limitadas, al realizar el montaje se deberá tener en cuenta, contemplando la posibilidad de modificar la distancia entre ejes para poder tensor correctamente la correa, o bien tensor la transmisión mediante un rodillo tensor. El diámetro de este último no deberá ser nunca inferior al de la polea menor.

### Tolleranze sull'interasse

### Distance between centres tolerance

### Toleranzen des achsenabstands

### Tolérance de l'entraxe

### Tolerancia en la distancia entre ejes

Lunghezza primitiva / Pitch length / Teilkreislänge Longueur primitive / Longitud primitiva (mm)	Tolleranze sull'interasse / Distance between centres tolerance Toleranzen des achsenabstands / Tolérance de l'entraxe / Tolerancia en la distancia entre ejes
da 127 a 254	± 0,2
da 254 a 381	± 0,23
da 381 a 508	± 0,25
da 508 a 762	± 0,30
da 762 a 1016	± 0,33
da 1016 a 1270	± 0,38
da 1270 a 1524	± 0,41
da 1524 a 1778	± 0,43
oltre 1778	

\* Aggiungere ±0,03 per ogni 254 mm di lunghezza supplementare

\* Add ±0,03 for each 254 mm of extra length

\* Pro 254 mm zusätzlicher Länge ±0,03 hinzufügen

\* Ajouter ±0,03 pour chaque 254 mm de longueur supplémentaire

\* Agregar ±0,03 por cada 254 mm de longitud adicional

### Tolleranza sulla larghezza delle cinghie

### Belt width tolerance

### Toleranzen der Riemenbreite

### Tolérance de la largeur de la courroie

### Tolerancia en el ancho de la correa

Larghezza della cinghia Belt width Riemenbreite Largeur de la courroie Anchura de la correa	Tolleranza in mm per lunghezza da 0 a 838,2 Tolerance in mm for length from 0 to 838,2 Toleranz in mm auf Längen von 0 bis 838,2 Tolérance en mm pour longueur de 0 à 838,2 Tolerancia en mm para longitud entre 0 y 838,2	Tolleranza in mm per lunghezza da 838,2 a 1676,4 Tolerance in mm for length from 838,2 to 1676,4 Toleranz in mm auf Längen von 838,2 bis 1676,4 Tolérance en mm pour longueur de 838,2 à 1676,4 Tolerancia en mm para longitud entre 838,2 y 1676,4	Tolleranza in mm per lunghezza da 1676,4 e oltre Tolerance in mm for length from 1676,4 and over Toleranz in mm auf Längen von 1676,4 und mehr Tolérance en mm pour longueur de 1676,4 et plus Tolerancia en mm para longitud entre 1676,4 y superiores
fino a 38,1	+0,8 -0,8	+0,8 -1,2	+0,8 -1,2
da 38,1 a 50,8	+0,8 -1,2	+1,2 -1,2	+1,2 -1,6
da 50,8 a 63,5	+1,2 -1,2	+1,2 -1,6	+1,6 -1,6
da 63,5 a 76,2	+1,2 -1,6	+1,6 -1,6	+1,6 -2,0
da 76,2 a 101,6	+1,6 -1,6	+1,6 -2,0	+2,0 -2,0
da 101,6 a 177,8	+2,4 -2,4	+1,6 -2,0	+2,0 -2,0
oltre 177,8			+4,8 -6,4



**Cinghie a doppia dentatura HTD® / HTD® Double toothed timing belts**  
**HTD® Zahnriemen mit doppelter verzahnung / Courroies dentées a double denture HTD®**  
**Correa dentadas con doble dentado HTD®**

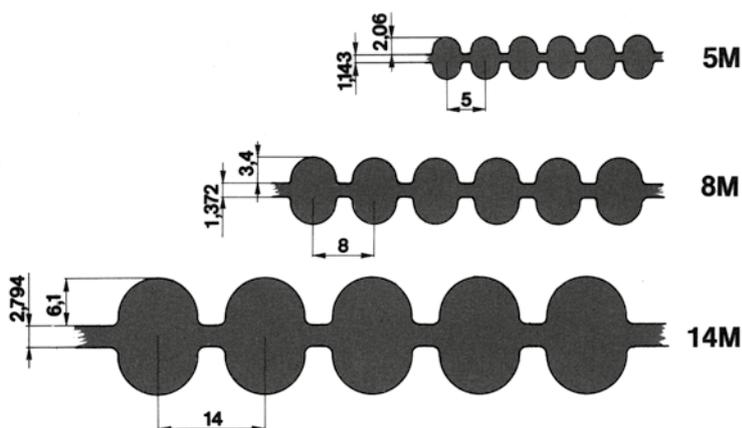

**HTD® 5M**

Passo 5 mm / Pitch 5 mm / Teilung 5 mm  
 Pas 5 mm / Paso 5 mm

Tipo di cinghia Belt type Riementyp Type de courroie Tipo de correa	N. denti N. of teeth Zahnezahl N. bre de dents Cantidad de dientes	Lunghezza primitiva Pitch length Teilkreislänge Longueur primitive Longitud primitiva (mm)
DD 425 5M	85	425
DD 475 5M	95	475
DD 500 5M	100	500
DD 600 5M	120	600
DD 615 5M	123	615
DD 640 5M	128	640
DD 670 5M	134	670
DD 700 5M	140	700
DD 755 5M	151	755
DD 800 5M	160	800
DD 835 5M	167	835
DD 890 5M	178	890
DD 935 5M	187	935
DD 1100 5M	220	1100
DD 1200 5M	240	1200

**HTD® 8M**

Passo 8 mm / Pitch 8 mm / Teilung 8 mm  
 Pas 8 mm / Paso 8 mm

Tipo di cinghia Belt type Riementyp Type de courroie Tipo de correa	N. denti N. of teeth Zahnezahl N. bre de dents Cantidad de dientes	Lunghezza primitiva Pitch length Teilkreislänge Longueur primitive Longitud primitiva (mm)
DD 480 8M	60	480
DD 560 8M	70	560
DD 600 8M	75	600
DD 640 8M	80	640
DD 720 8M	90	720
DD 800 8M	100	800
DD 880 8M	110	880
DD 960 8M	120	960
DD 1040 8M	130	1040
DD 1120 8M	140	1120
DD 1200 8M	150	1200
DD 1280 8M	160	1280
DD 1360 8M	170	1360
DD 1440 8M	180	1440
DD 1600 8M	200	1600
DD 1760 8M	220	1760
DD 1800 8M	225	1800
DD 2000 8M	250	2000
DD 2400 8M	300	2400
DD 2600 8M	325	2600
DD 2800 8M	350	2800

**HTD® 14M**

Passo 14 mm / Pitch 14 mm / Teilung 14 mm  
 Pas 14 mm / Paso 14 mm

Tipo di cinghia Belt type Riementyp Type de courroie Tipo de correa	N. denti N. of teeth Zahnezahl N. bre de dents Cantidad de dientes	Lunghezza primitiva Pitch length Teilkreislänge Longueur primitive Longitud primitiva (mm)
DD 1610 14M	115	1610
DD 1778 14M	127	1778
DD 1890 14M	135	1890
DD 2100 14M	150	2100
DD 2310 14M	165	2310
DD 2450 14M	175	2450
DD 2590 14M	185	2590
DD 2800 14M	200	2800
DD 3150 14M	225	3150

Tipo cinghia / Belt type / Riementyp Type de courroie / Tipo de correa	Larghezza cinghie di normale scorta a magazzino / Width of belt normally in stock / Breite Ersatzriemen am Lager Largeur courroie habituellement en stock / Anchura de la correa normalmente en existencia en el almacén
5M	9 - 15 - 25 - - - - - - - - - -
8M	20 - 30 - - - - 50 - - - - 85
14M	40 - 55 - - 85

**Passo 3M - 5M**

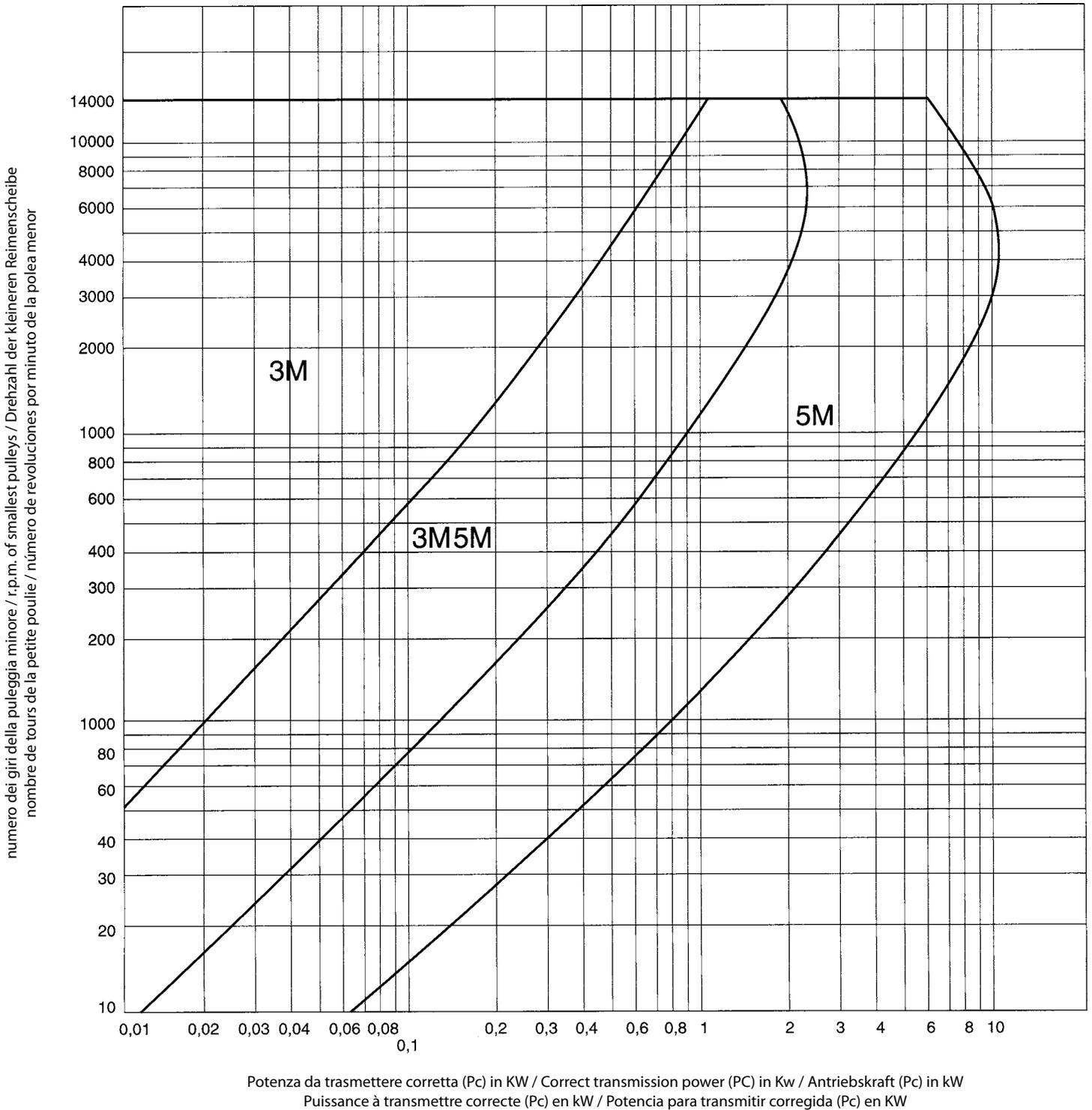

Per condizioni di esercizio non comprese nel presente grafico interpellare i nostri tecnici.

Contact our technicians for operating conditions not included in this graph.

Für Betriebsbedingungen, die nicht in dieser Grafik berücksichtigt sind, wenden Sie sich an unseren Technischen Kundendienst.

Consulter notre service technique pour des conditions d'exercice ne figurant pas dans le présent graphique.

Para condiciones de uso no comprendidas en el presente gráfico, consultar con el servicio técnico de la empresa.

**Passo 8M - 14M - 20M**

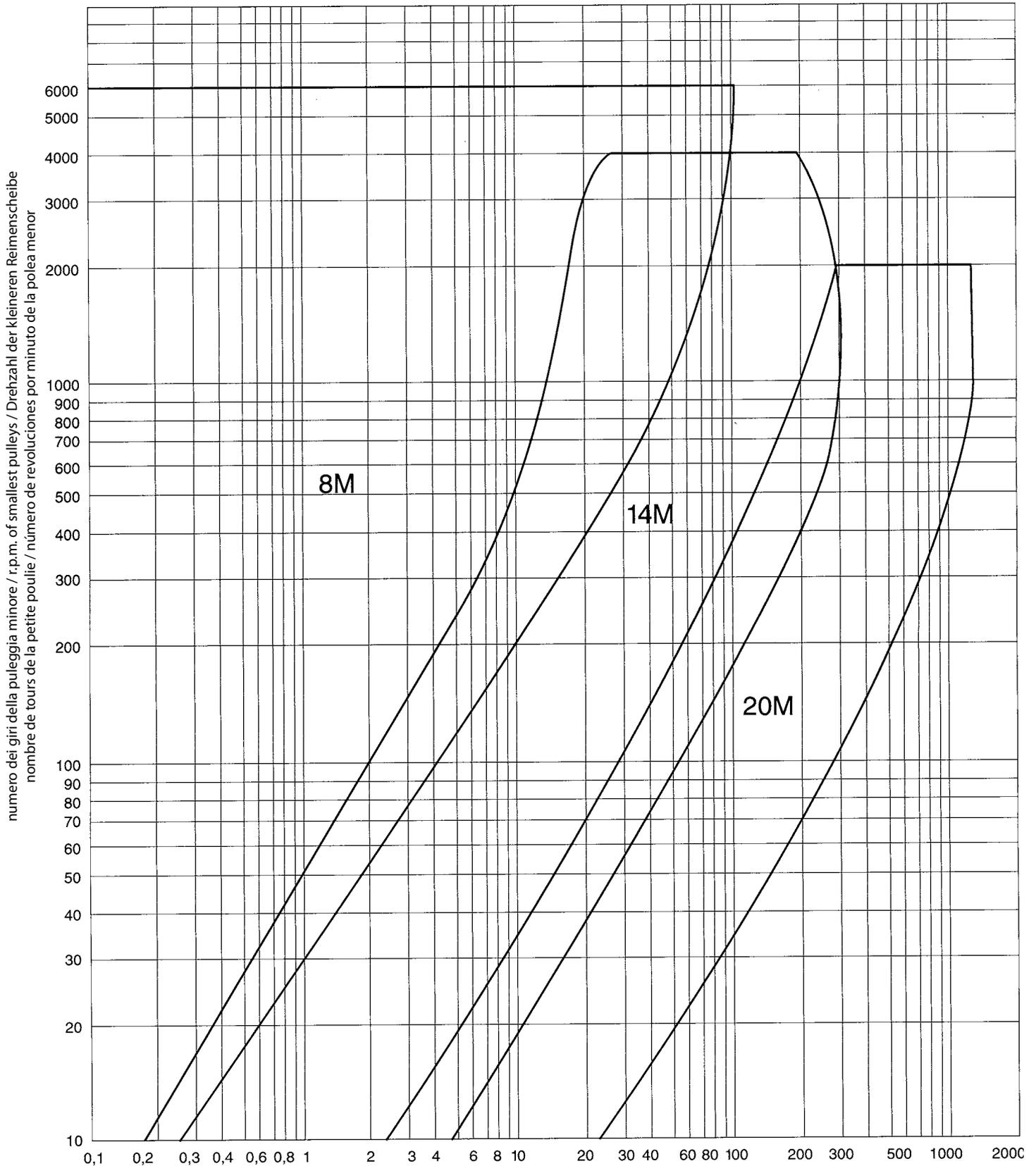

Potenza da trasmettere corretta (Pc) in kW / Correct transmission power (PC) in kW / Antriebskraft (Pc) in kW  
 Puissance à transmettre correcte (Pc) en kW / Potencia para transmitir corregida (Pc) en kW

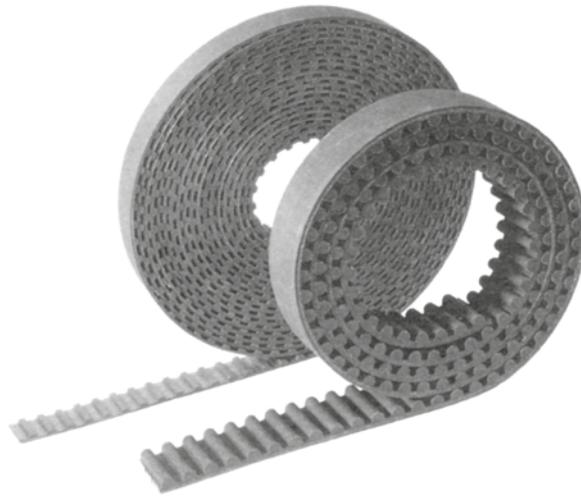

Passo/Pitch/Teilung/Pas/Paso	<b>MXL (2,032)</b>	<b>XL (5,08)</b>	<b>L (9,525)</b>	<b>H (12,7)</b>
Larghezza della cinghia Belt width Riemenbreite Largeur de la courroie Anchura de la correa	025 - - - -	025 031 037 - -	- - - 050 075 100	- - - 050 075 100

**Cinghie dentate passo metrico a metraggio in poliuretano / Timing belts metric pitch in meters**  
**Zahnriemen metrische Teilung der meter / Courroies dentées pas métrique a metrage**  
**Correas dentadas con paso en mm en metros**

Passo/Pitch/Teilung/Pas/Paso	<b>T5 (5 mm)</b>	<b>T10 (10 mm)</b>
Larghezza della cinghia Belt width Riemenbreite Largeur de la courroie Anchura de la correa	10 16 25 32	- 16 25 32 50

**Cinghie dentate HTD® a metraggio / HTD® Timing belts in meters**  
**HTD® Meterweise Zahnriemen / Courroies dentées HTD® a métrage / Correas dentadas HTD® a metros**

Passo/Pitch/Teilung/Pas/Paso	<b>HTD® 3M</b>	<b>HTD® 5M</b>	<b>HTD® 8M</b>	<b>HTD® 14M</b>
Larghezza della cinghia Belt width Riemenbreite Largeur de la courroie Anchura de la correa	9 12 15 - - - -	10 - 15 20 25 -	- - 15 20 25 30 -	- - - - - 40 55

# Piastre bloccaggio per cinghie / Clamping plates for belts Klemmplatten für Zahnriemen / Plaque tendouses pour courroies Placas tensoras para correas



Le cinghie dentate, utilizzate per trasformare il moto rotatorio delle pulegge, in moto rettilineo alternato di tavole o di altri dispositivi, hanno la necessità di avere le estremità delle stesse ancorate alle parti mobili (fig. 1) o a quelle fisse (fig. 2) dei particolari da movimentare. Questo fissaggio deve essere eseguito con cura, per evitare che la cinghia possa essere danneggiata o indebolita nel punto di attacco. È stata realizzata pertanto questa serie di piastre che facilitano il corretto bloccaggio delle cinghie sui relativi ancoraggi.

The timing belts used for converting the rotary motion of the pulleys into linear motion of tables or other devices need to have their ends anchored to the mobile sections (fig. 1) or the fixed sections (fig. 2) of the parts to be moved. Such fastening must be done carefully to avoid the belt being damaged or weakened at the anchorage point. For this reason a set of plates has been created, that make it easier to lock the belt in the correct position on the relative anchorage points, has been created.

Bei Zahnriemen, die für die Übertragung der Rotationsbewegung der Scheibe in eine geradlinige abwechselnde Bewegung von Tischen oder anderen Vorrichtungen verwendet werden, müssen deren Enden am beweglichen (abb. 1) oder festen Teil (abb. 2) der anzutreibenden Elemente verankert werden. Diese Befestigung muß äußerst sorgfältig erfolgen, damit der Riemen nicht beschädigt oder an der Verbindungsstelle geschwächt wird. Aus diesem Grund wurde diese Serie von Platten realisiert, welche die korrekte Blockierung der Riemen an den entsprechenden Verankerungen vereinfachen.

Les extrémités des courroies dentées, utilisées pour transformer le mouvement rotatif des poulies, en un mouvement rectiligne alterné de plan ou autres dispositifs, doivent être ancrées dans les parties mobiles (fig. 1) ou dans celles fixes (fig. 2) des pièces à mettre en mouvement. Cette fixation doit être effectuée avec soin, pour éviter que la courroie puisse être endommagée ou affaiblie au niveau du point d'attache. Par conséquent, une série de plaques qui facilitent le blocage correct des courroies sur les ancrages correspondants, a été réalisée.

Las correas dentadas, que se utilizan para transformar el movimiento rotatorio de las poleas en movimiento rectilíneo alternado de mesas u otros dispositivos, deben tener los extremos anclados a las partes móviles (fig. 1) o fijas (fig. 2) de los elementos que se deben movilizar. Esta fijación se debe realizar con cuidado, para evitar que la correa se dañe o debilite en el punto de montaje. Para ello se ha realizado una serie de placas que facilitan el correcto bloqueo de las correas en sus respectivos anclajes.

**Materiale:**  
alluminio 6082 T6 UNI  
9006/4 adatto al trattamento  
anodico

**Material:**  
aluminium 6082 T6 UNI  
9006/4 suitable for anodic  
treatment

**Werkstoff:**  
aluminium 6082 T6 UNI  
9006/4 geeignet für  
anodischen oxydation

**Matière:**  
aluminium 6082 T6 UNI  
9006/4 apte au traitement  
anodique

**Material:**  
aluminio 6082 T6 UNI  
9006/4 apto para la  
oxidacion anodica

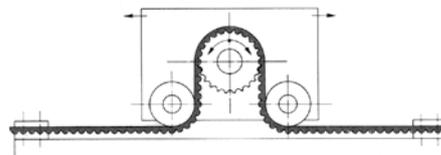
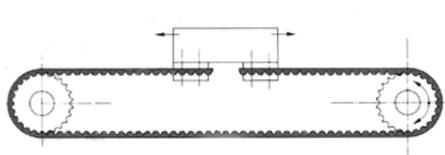

## Piastre di bloccaggio per cinghie passo in pollici

## Clamping plates for belts imperial pitch

## Klemmplatten für Zahnriemen Zoll Reilung

## Plaques tendouses pour courroies pas en pouces

## Láminas tensoras para correas paso en pulgadas

Passo Pitch Teilung Pas Paso	b	d	e	L	H	A Larghezza della cinghia / Belt width Riemenbreite / Largeur de la courroie / Anchura de la correa					
						025	031*	037	050	075	100
						B					
XL	6	5,5	3,5	42,5	8	25,5	27	28,5	-	-	-
L	8	9,0	5,0	76,6	15	-	-	-	39	45	51,5
H	10	11,0	9,0	106,9	22	-	-	-	45	51	57,5

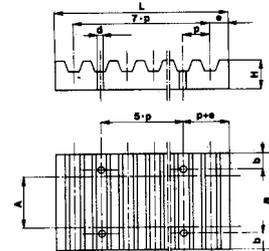

## Piastre di bloccaggio per cinghie passo metrico

## Clamping plates for metric belts

## Klemmplatten für Zahnriemen

## Plaques tendouses pour courroies metriques

## Láminas tensoras para correas metricas

Passo Pitch Teilung Pas Paso	b	d	e	L	H	A Larghezza della cinghia / Belt width Riemenbreite / Largeur de la courroie / Anchura de la correa					
						6	10	16	25	32	50
						B					
5	6	5,5	3,2	41,4	8	-	29	35	44	-	-
10	8	9,0	5,0	80,0	15	-	-	41	50	57	75

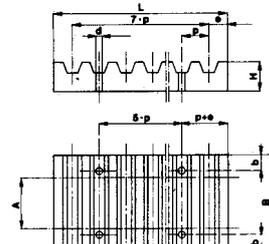

## Piastre di bloccaggio per cinghie HTD®

## HTD® Clamping plates for belts imperial pitch

## HTD® Klemmplatten für Zahnriemen

## Plaques tendouses pour courroies HTD®

## Láminas tensoras para correas HTD®

Passo Pitch Teilung Pas Paso	b	d	e	L	H	A Larghezza della cinghia / Belt width Riemenbreite / Largeur de la courroie / Anchura de la correa												
						6	10	15	20	25	30	40	50	55	85	115	170	
						B												
*3M	5	4,5	2,0	25,0	5	21	24	30	-	-	-	-	-	-	-	-	-	-
5M	6	5,5	3,2	41,8	8	-	28	34	-	44	-	-	-	-	-	-	-	-
8M	8	9,0	5,0	66,0	15	-	-	40	45	-	55	-	75	-	110	-	-	-
14M	10	11,0	9,0	116,0	22	-	-	-	-	-	-	71	86	116	146	201	-	-

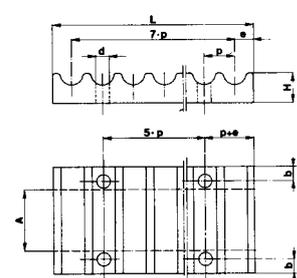

**Siano noti:**

- potenza motore (P) in kW
- caratteristiche motore (tab. 1)
- tipo di utilizzatore (tab. 2)
- tipo di funzionamento (tab. 3)
- ingombri max della trasmissione
- rapporto di trasmissione

1°) Occorrerà considerare la potenza del motore, corretta dai fattori che influiscono nella trasmissione: (Ct)

- a) classe appartenenza motore (tab. 1) da cui: il fattore servizio Fs (tab. 2)
- b) rapporto di trasmissione  $\tau$  (tab. 3) per determinare Fm (solo per trasmissioni moltiplicatrici)
- c) tipo di funzionamento Ff (tab. 3) da cui:

**Given:**

- motor power (P) in kW
- motor specifications (Table 1)
- type of application (Table 2)
- type of operation (Table 3)
- max. transmission dimensions
- transmission ratio

1°) Motor power must be corrected by the factors influencing transmission: (Ct)

- a) motor classification (Table 1), with service factor Fs (Table 2)
- b) transmission ratio  $\tau$  (Table 3) to calculate Fm, (for overgear transmissions only)
- c) type of Ff operation (Table 3) giving:

**Bekannt sind:**

- die Motorenleistung (P) in kW
- die Art des Motors (Tab. 1)
- die Anwendung des Motors (Tab. 2)
- die Betriebsart des Motors (Tab. 3)
- die maximalen Abmessungen der Getriebe
- die Übersetzung

1°) Zu berücksichtigen ist die Motorleistung, berichtigt durch die die Übertragung beeinflussenden Faktoren (Ct)

- a) Zugehörigkeitsklasse des Motors (Tab. 1); davon die jeweilige Anwendungsart (Faktor Fs, Tab. 2)
- b) das Übersetzungsverhältnis  $\tau$  (Tab. 3) zwecks Bestimmung des Faktors Fm (nur für Übersetzungsgetriebe)
- c) die Betriebsart des Motors (Tab. 3) daraus ergibt sich:

**Facteurs à connaître:**

- puissance du moteur (P) en kW
- caractéristiques du moteur (tab. 1)
- type d'utilisateur (tab. 2)
- type de fonctionnement (tab. 3)
- dimensions max. de la transmission
- rapport de transmission

1°) Il faudra tenir compte de la puissance du moteur, corrigée par les facteurs influant dans la transmission: (Ct)

- a) classe d'appartenance du moteur (tab. 1) dont: le facteur de régime Fs (tab. 2)
- b) le rapport de transmission  $\tau$  (tab.3) pour déterminer Fm (seulement pour les transmissions multiplicatrices)
- c) type de fonctionnement Ff (tab. 3)

**Sean conocidos:**

- potencia motor (P) en kW
- características motor (tabla 1)
- tipo de utilizador (tabla 2)
- tipo de funcionamiento (tabla 3)
- dimensiones máx. de la transmisión
- relación de transmisión

1°) Será necesario considerar la potencia del motor, corregida por los factores que influyen en la transmisión (Ct)

- a) clase a la cual pertenece el motor (tabla 1) en la cual: el factor servicio Fs (tabla 2)
- b) relación de transmisión  $\tau$  (tabla 3) para determinar Fm, (sólo para transmisiones multiplicadoras)
- c) tipo de funcionamiento Ff (tabla 3) por consiguiente:

$$Ct = Fs + Fm + Ff = Pc \text{ (Potenza corretta / corrected power / berichtigte Leistung / Puissance corrigée / Potencia corregida) } = P.Ct$$

2°) Per determinare il passo della cinghia si potrà interpretare il grafico a pagg. 159 - 164 - 167 - 172 - 173 considerando la Pc ed il n° giri dell'utilizzatore.

3°) Per la scelta dei tipi di puleggia, ci avvarremo del rapporto di trasmissione scegliendo tra la tipologia indicata nella gamma del passo di cui al punto 2), dagli ingombri a disposizione (diametro max e interasse); occorrerà prestare attenzione e scartare i diametri di puleggia molto piccoli.

4°) La determinazione dell'interasse e sviluppo effettivi della cinghia, si otterranno con le seguenti. formule:  
Svt = Sviluppo totale cinghia  
D = Diametro max puleggia  
d = Diametro min puleggia  
lt = Interasse teorico

2°) To calculate belt pitch, the graph on pages 159 - 164 - 167 - 172 - 173 must be interpreted, considering the Pc and the user RPMs.

3°) In choosing the type of pulley, we must use transmission ratio  $t$ , selecting type from the pitch range indicated in point 2), and considering the available space (dimensions; max. diameter and center distance). It is best to reject very small pulley diameters.

4°) To calculate the center distance and effective length of the belt, use the following formulas:  
Svt = Total belt length  
D = Max pulley diameter  
d = Min pulley diameter  
lt = Theoretical center distance

2°) Zur Definition des Zahnabstandes kann die Grafik auf den Seiten 159 - 164 - 167 - 172 - 173 hinzugezogen werden; dabei sind die Faktoren Pc und die Upm bei der jeweiligen Anwendungsart zu berücksichtigen.

3°) Vom Übertragungsverhältnis  $t$  ausgehend, kann unter Berücksichtigung der unter Punkt 2) aufgeführten Abstände sowie der zur Verfügung stehenden Einbaumaßnahmen (max. Durchmesser, Mittenabstand) der jeweilige Riemenscheibentyp ausgesucht werden; extrem kleine Riemenscheiben sollten nicht ausgesucht werden.

4°) Der Mittenabstand und die effektive Riemenlänge werden nach den nachstehenden Formeln berechnet:  
Svt = Gesamtlänge des Riemens  
D = maximaler Riemenscheibendurchmesser  
d = minimaler Riemenscheibendurchmesser  
lt = theoretischer Mittenabstand

2°) Pour déterminer le pas de la courroie, se reporter au graphique figurant en page 159 - 164 - 167 - 172 - 173 en tenant compte de la Pc et du nombre de tours.

3°) Pour choisir le type de poulie, il faudra utiliser le rapport de transmission  $t$  en sélectionnant le type figurant dans la gamme de pas au point 2), des dimensions disponibles (diamètre max. et entre-axe); veiller à éviter les diamètres de poulie très petits.

4°) La détermination de l'entre-axe et le développement effectifs de la courroie seront obtenus à l'aide des formules suivantes:  
Svt = Développement total de la courroie  
D = Diamètre maximum de la poulie  
d = Diamètre minimum de la poulie  
lt = Entreaxe théorique

2°) Para determinar el paso de la correa se podrá interpretar el gráfico de las págs. 159-164-167-172-173, considerando la Pc y el n° de revoluciones del utilizador.

3°) Para la elección de los tipos de polea, nos basaremos sobre la relación de transmisión  $t$ , eligiendo entre los tipos indicados en la gama del paso, punto 2), entre las dimensiones disponibles (diámetro máx. y distancia intermedia); será necesario observar con atención y descartar los diámetros de polea demasiado pequeños.

4°) Distancia intermedia y desarrollo efectivos de la correa podrán ser establecidos mediante las siguientes fórmulas:  
Svt = Desarrollo total correa  
D = Diámetro máx. polea  
d = Diámetro min. polea  
lt = Distancia intermedia teórica

$$S_{vt} = 2 \cdot l_t + 1,57 (D + d) + \frac{(D - d)^2}{79 \cdot l_t}$$

Pertanto, determinato lo sviluppo teorico della cinghia, in base alle dimensioni standard di catalogo (Sve) si determinerà l'interasse reale (lr) tra le pulegge:

Having calculated theoretical belt length, on the basis of the standard catalogue dimensions (Sve), the real center distance (lr) between the pulleys can be calculated:

Nach der Definition der theoretischen Riemenlänge kann der tatsächliche Mittenabstand (lr) ausgehend von den im Katalog aufgeführten Standardabmessungen (Sve) wie folgt berechnet werden:

Par conséquent, une fois déterminé le développement théorique de la courroie, en fonction des dimensions standard du catalogue (Sve); on déterminera l'entre-axe réel (lr) entre les poulies:

Por lo tanto, una vez determinado el desarrollo teórico de la correa en base a las dimensiones estándar de catálogo (Sve), se determinará la distancia intermedia real (lr) entre las poleas:

$$l_r = l_t \pm \frac{S_{vt} - S_{ve}}{2} \text{ (attenzione!!! / attention!!! / attention!!! / attention!!! / atencion!!!) } \quad |r > \frac{D + d}{2}$$

5°) Per determinare il n° di denti in presa Zp della puleggia minore, si dovrà conoscere  
Pa = passo cinghia (vedi punto 2)  
lr = Interasse reale  
Z = n° denti puleggia maggiore  
z = n° denti puleggia minore

5°) To calculate the number of cogs engaged Zp on the smaller pulley we must know:  
Pa = belt pitch (see point 2)  
lr = real center distance  
Z = nr. teeth larger pulley  
z = nr. teeth smaller pulley

5°) Zur Definition der Anzahl der benutzten Zähne Zp der kleine Riemenscheibe, man muß können:  
Pa = Zahnabstandes (siehe Punkt 2)  
lr = effektiver Mittenabstand  
Z = Anzahl der Zähne der größeren Riemenscheibe  
z = Anzahl der Zähne der kleineren Riemenscheibe

5°) Pour déterminer le nombre de dents en prise Zp de la poulie plus petite, il faudra connaître:  
Pa = pas de la courroie (voir point 2)  
lr = entre-axe réel  
Z = Nombre de dents de la poulie plus grande  
z = Nombre de dents de la poulie plus petite

5°) Para determinar el n° de dientes en toma Zp de la polea menor, será necesario conocer:  
Pa = Paso correa (ver punto 2)  
lr = Distancia intermedia real  
Z = n° de dientes polea mayor  
z = n° de dientes polea menor

$$Z_p = \left[ 0,5 - \frac{4 \cdot P_a}{79 \cdot I_r} (Z - z) \right] z$$

Dalla tabella n° 8 si ricaverà il coefficiente correttivo in funzione dei denti in presa (Cc) per calcolare la larghezza cinghia (CL)

Using Table 8, we can calculate the correction coefficient on the basis of the number of teeth engaged (Cc), in order to calculate belt width (CL)

Auf der Grundlage der Tabelle Nr. 8 können wir zur Berechnung der Riemenbreite (CL) den Korrekturfaktor in Abhängigkeit zu den benutzten Zähnen (Cc) entnehmen.

Consulter le tableau n° 8 pour obtenir le coefficient correcteur en fonction des dents en prise (Cc) pour calculer la largeur de la courroie (CL)

En la tabla n° 8 se obtiene el coeficiente correctivo en función de los dientes en toma (Cc) para calcular la longitud de la correa (CL)

6°) La determinazione delle prestazioni base (Pb) delle cinghie in funzione del passo, del profilo, del n° dei denti e dei giri della puleggia minore, si effettua tramite la lettura delle tabelle 10/1-2-3-4-5; 11/1-2-3-4-5; 12/1-2-3-4, secondo il profilo del dente della trasmissione scelta.

6°) To calculate the base performance (Pb) of the belts as a function of pitch, profile, nr. of cogs and RPMs of the smaller pulley, use Tables 10/1-2-3-4-5, 11/1-2-3-4-5, 12/1-2-3-4, following the cog profile of the choosing transmission.

6°) Die Definition der Standardleistung (Pb) der Riemen erfolgt in Abhängigkeit zum Zahnabstand, zum Profil, zur Anzahl der Zähne und zur Zahl der Umdrehungen der kleineren Riemenscheibe über die Tabellen 10/1-2-3-4-5, 11/1-2-3-4-5, 12/1-2-3-4, entsprechend der Zahnprofil der gewählt Übertragung.

6°) La détermination des prestations de base (Pb) des courroies en fonction du pas, du profil, du nombre de dents et des tours de la poulie plus petite s'effectue en consultant les tableaux 10/1-2-3-4-5; 11/1-2-3-4-5; 12/1-2-3-4, suivant le profil du dent de la transmission choisie.

6°) La determinación de las prestaciones base (Pb) de las correas en función del paso, del perfil, del n° de dientes y de las revoluciones de la polea menor, se efectúa mediante la lectura de las tablas 10/1-2-3-4-5; 11/1-2-3-4-5; 12/1-2-3-4, según el perfil de la diente de la transmisión selecta.

7°) Il coefficiente di larghezza cinghia (CL) è così determinato:

7°) The belt width coefficient (CL) is calculated as follows:

7°) Der Faktor der Riemenbreite (CL) berechnet sich wie folgt:

7°) Le coefficient de largeur de la courroie (CL) est déterminé comme suit:

7°) El coeficiente de ancho de la correa (CL) se establece en el siguiente modo:

$$CL = \frac{P_c}{C_c \cdot P_b} \text{ dove: / where: / dabei ist: / d'ou: / donde:}$$

Pc = Potenza corretta (punto 1)

Pc = Corrected power (point 1)

Pc = korrigierte Leistung (siehe Punkt 1)

Pc = Puissance corrigée (point 1)

Pc = Potencia corregida (punto 1)

Cc = Coefficiente correttivo (punto 5)

Cc = Correction coefficient (point 5)

Cc = Korrekturfaktor (siehe Punkt 5)

Cc = Coefficient correcteur (point 5)

Cc = Coeficiente correctivo (punto 5)

Pb = Prestazioni base (punto 6)

Pb = Base performance (point 6)

Pb = Standardleistung (siehe Punkt 6)

Pb = Prestations de base (point 6)

Pb = Prestaciones base (punto 6)

per cui, dalle tabelle n° 6-7 si ricaverà la larghezza cinghia più prossima al CL calcolato, facendo attenzione, dove esistono, a scegliere quelle in neretto, più facilmente disponibili a magazzino.

use Tables 6-7 to identify the belt width closest to the calculated CL, choosing when possible those in bold print, which are regularly stocked in the warehouse and more readily available.

Aus den Tabellen Nr. 6-7 ergibt sich die Riemenlänge, die sich so weit wie möglich an den berechneten Faktor CL annähert; vorzugsweise sollten die in Fettdruck aufgeführten Längen ausgesetzt werden, da diese auf Lager und somit sofort auslieferungsbereit sind.

Par conséquent, on prendra la largeur de courroie la plus proche au CL calculé dans les tableaux n° 6-7 en faisant attention de choisir celles en noir, si elles existent, car plus facilement disponibles en stock.

por lo cual, en la tabla n° 6-7 será posible obtener el ancho de la correa más próximo al CL calculado, cuidando elegir, cuando existan, entre aquellas en negrita, más fácilmente disponibles en almacén.

TABELLA N. 1  
Classificazione dei motori

TABLE N. 1  
Motor classification

TABELLE N. 1  
Klassifikation der Motoren

TABLEAU N. 1  
Classement des moteurs

TABLA N. 1  
Tipo del motor

Tipo di motore / Type of motor Motorenart / Type de moteur / Tipo de motor *		Classe / Class / Klasse / Classe / Clase		
		I	II	III
<b>sovraccarico istantaneo in % del carico di regime</b> <b>instantaneous overload as % of full power load</b> <b>Augenblicksbelastung der Gesamtlast in %</b> <b>surcharge instantanée en % en fonction de la charge de régime</b> <b>sobrecarga instantánea en % de la carga de régimen</b>		<b>fino a 149 / up to 149</b> <b>bis zu 149 / jusqu'à 149</b> <b>hasta 149</b>	<b>da 150 a 249 / from 150 to 249</b> <b>von 150 bis 249 / de 150 à 249</b> <b>entre 150 y 249</b>	<b>da 250 a 400 / from 250 to 400</b> <b>von 250 bis 400 / de 250 à 400</b> <b>entre 250 y 400</b>
<b>Motori elettrici a corrente alternata</b> <b>Electric alternating current motors</b> <b>Wechselstrommotoren</b> <b>Moteurs électriques à courant alternatif</b> <b>Motores eléctricos de corriente alterna</b>	Asincroni / Asynchronous Asynchronmotoren Asíncronos / Asíncrónicos	-	-	tutti / all / alle tous / todos
	Asincroni trifase Three-phase asynchronous Drehstrom-Asynchronmotoren Asíncronos triphasés Asíncrónicos trifásicos	Avviamento stella-triangolo Star-delta starting Stern-Drecksstart Démarriage étoile-triangle Arranque estrella-triángulo	Avviamento diretto Direct starting Direktstart Démarriage direct Arranque directo	A doppia gabbia Double cage Doppelkäfiganker A double cage De doble jaula
	Sincroni Synchronous Synchro-motoren Synchrones Síncrónicos	-	A coppia normale Normal torque Mit normalem Drehmoment A couple normal De par normal	Ad alta coppia High torque mit hohem Drehmoment A couple élevé De alto par
<b>Motori elettrici a corrente continua</b> <b>Electric direct current motors</b> <b>Gleichstrommotoren</b> <b>Moteurs électriques à courant continu</b> <b>Motores eléctricos de corriente continua</b>	Eccitazione in deviazione Deflection excitation mit Nebenschlußerregung Excitation en déviation Excitación en desviación	Eccitazione in compound Deflection excitation mit Nebenschlußerregung Excitation en déviation Excitación en desviación	Eccitazione in serie Series excitation mit Reihenschlußerregung Excitation en série Excitación en serie	
<b>Motori a combustione interna / Internal-combustion engine</b> <b>Verbrennungsmotoren / Moteurs à combustion interne</b> <b>Motores de combustión interna</b>	ad 8 cilindri ed oltre 8 cylinder and over 8 Zylinder und mehr à 8 cylindres et plus De 8 o mas cilindros	a 6 cilindri 6 cylinder 6 Zylinder à 6 cylindres De 6 cilindros	a 4 cilindri o meno 4 cylinder or less 4 Zylinder und weniger à 4 cylindres ou moins De 4 o menos cilindros	
<b>Motori idraulici / Hydraulic motors</b> <b>Hydraulikmotoren / Moteurs hydrauliques</b> <b>Motores hidráulicos, línea de ejes</b>	-	-	tutti / all alle / tous / todos	

(\*) Quando si conoscono la potenza installata ed i relativi sovraccarichi, la classificazione dovrà essere fatta sulla base di tali valori.

(\*) When installed power and relative overloads are known, classification should be done on the basis of these values.

(\*) Bei Kenntnis der installierten Leistung und der entsprechenden Überlasten ergibt sich die Klassifikation aus diesen Werten.

(\*) Lorsque la puissance installée et les surcharges respectives sont connues, le classement devra être fait sur la base de ces valeurs.

(\*) Cuando se conocen la potencia instalada y las respectivas sobrecargas, la clasificación deberá ser efectuada sobre la base de dichos valores.

**TABELLA N. 2**  
Fattore di servizio Fs  
secondo la natura del carico

**TABLA N. 2**  
Service factor Fs depending  
on type of load

**TABELLE Nr. 2**  
Anwendungsart (Faktor  
Fs) in Abhängigkeit zur  
Belastung

**TABLEAU N. 2**  
Facteur de régime Fs en  
fonction de la nature de la  
charge

**TABLA N. 2**  
Factor de servicio Fs según  
la naturaleza de la carga

Applicazioni / Applications / Anwendungsbereich / Applications / Aplicaciones					Classe / Class / Klasse / Classe / Clase		
					I	II	III
Agitatori, miscelatori	Stirrers, mixers	Rührwerke, Mischwerke	Agitateurs, mélangeurs	Agitadores, mezcladores	1,4	1,6	1,8
					1,5	1,7	1,9
Aspiratori e ventilatori	Exhaust systems, fans	Sauglüfter, Ventilatoren	Aspirateurs et ventilateurs	Aspiradores y ventiladores	1,6	1,8	2,0
					1,8	2,0	2,2
Centrifughe	Centrifuges	Zentrifugen	Centrifuges	Centrifugas	1,7	1,9	-
Compressori	Compressors	Kompressoren	Compresseurs	Compresores	1,6	1,7	1,8
					2,0	2,2	2,4
Elevatori	Elevators	Elevatoren	Elévateurs	Elevadores	1,6	1,8	2,0
Frantoi	Crushers	Brecher	Broyeurs	Almazaras	-	2,2	2,5
Gruppi generatori ed eccitatori	Generator sets and excitation units	Generatoren- und Erregeraggregate	Groupes générateurs et excitateurs	Unidades generadoras y excitadoras	1,6	1,8	2,0
Linea d'alberi	Hydraulic motors	Hydraulikmotoren	Moteurs hydrauliques	Línea de ejes	1,5	1,7	1,9
Macchine per cartiere	Paper mill machines	Maschinen zur Papierverarbeitung	Machines pour fabriques de papier	Máquinas para fábricas de papel	1,4	1,6	1,8
					1,7	1,9	2,1
Macchine per ceramiche e laterizi	Brick and tile machines	Maschinen für die Keramik- und Ziegelindustrie	Machines pour céramiques et briques	Máquinas para cerámica, tejas y ladrillos	1,5	1,7	1,9
					1,8	2,0	2,2
Macchine per lavanderia	Laundry machines	Maschinen für Großwäschereien	Machines pour blanchisseries	Máquinas para lavanderías	1,6	1,8	2,0
Macchine per lavorazione della gomma	Rubber-processing machines	Maschinen zur Gummiverarbeitung	Machines pour la transformation du caoutchouc	Máquinas para trabajar la goma	1,6	1,8	2,0
Macchine per lavorazione del legno	Woodworking machines	Maschinen zur Holzverarbeitung	Machines pour la transformation du bois	Máquinas para trabajar la madera	1,3	1,4	-
					1,4	1,6	-
Macchine per stampa	Printing machines	Druckmaschinen	Machines pour l'imprimerie	Máquinas para imprentas	1,4	1,6	1,8
Macchine per tessitura	Weaving machines	Webmaschinen	Machines pour le tissage	Máquinas textiles	1,5	1,7	-
					1,6	1,8	2,0
Macchine utensili	Machine tools	Werkzeugmaschinen	Machines-outils	Máquinas herramientas	1,4	1,6	1,8
					1,5	1,7	1,9
Molini a cilindri, a pale, molazze	Cylinder mills, ball mills, pan crushers	Walzen- und Kugelmühlen, Mühlsteine	Moulins à cylindres, pales, meules	Molinos de cilindros, de paletas, de muelas	1,7	1,9	2,1
Pompe	Pumps	Pumpen	Pompes	Bombas	1,5	1,7	1,9
					2,0	2,2	2,4
Setacci	Riddles	Siebe	Tamis	Tamiz	1,4	1,5	-
					1,5	1,7	-
Trasportatori	Conveyors	Förderbänder	Transporteurs	Transportadores	1,3	1,5	1,7
					1,6	1,7	1,8
					1,7	1,8	1,9
					1,7	1,9	2,0



**TABELLA N. 3**  
Coefficients correctivi Fm  
e Ff

**TABLA N. 3**  
Correstion coefficients Fm  
and Ff

**TABELLE Nr. 3**  
Korrekturfaktoren Fm und  
Ff

**TABLEAU N. 3**  
Coefficients corresteurs  
Fm et Ff

**TABLA N. 3**  
Coeficientes correctivos  
Fm y Ff

Per trasmissioni moltiplicatrici / For overgear transmissions Für Übersetzungsgetriebe / Pour transmissions multiplicatrices Para transmisiones multiplicadoras				Tipo di funzionamento Type of operation Betriebsart Type de fonctionnement Tipo de funcionamiento		Ff
Rapporto di trasmissione / Transmission ratio Übertragungsverhältnis / Rapport de transmission Relación de transmisión		Fm				
da / from / von de / entre	1	a / to / bis à / y	1,24	-	continuo per 8-10 ore per giorno / continuous, 8-10 hours a day kontinuierlich, 8-10 Std. pro Tag / continu pendant 8-10 heures par jour continuo durante 8-10 horas diarias	-
da / from / von de / entre	1,25	a / to / bis à / y	1,74	+ 0,10	continuo per 10-16 ore per giorno / continuous, 10-16 hours a day kontinuierlich, 10-16 Std. pro Tag / continu pendant 10-16 heures par jour continuo durante 10-16 horas diarias	+ 0,1
da / from / von de / entre	1,75	a / to / bis à / y	2,49	+ 0,20	continuo per 16-20 ore per giorno / continuous, 16-20 hours a day kontinuierlich, 16-20 Std. pro Tag / continu pendant 16-20 heures par jour continuo durante 16-20 horas diarias	+ 0,2
da / from / von de / entre	2,50	a / to / bis à / y	3,50	+ 0,30	con galoppino e rinvio / with belt tightener or drive unit mit Leitrolle oder Vorgelege / avec poulie folle ou renvoi con rodillo neutro o reenvío	+ 0,1
da / from / von de / entre			3,50	+ 0,50	intermittente o stagionale / intermittent or seasonal duty im Schrittbetrieb oder bei saisonmäßigem Betrieb intermittent ou saisonnier / Intermitente o de temporada	- 0,1

**TABELLA / TABLE / TABELLE / TABLEAU / TABLA N. 4**

**Numero minimo dei denti e diametro delle pulegge in funzione dei numeri di giri**  
Minimum number of pulley diameter and cogs, depending on RPMs  
Mindestanzahl der Zähne und Durchmesser der Riemenscheibe in Abhängigkeit zur Zahl der Umdrehungen  
Nombre minimum de dents et diamètre des poulies en fonction du nombre de tours  
Número mínimo de dientes y diámetro de las poleas en función del número de revoluciones

Tipo Type of belt Typ Type Tipo de correa	N° giri/1' puleggia piccola RPMs/small pulley Umdr. pro Sek./kleine Riemenscheibe Nombre de tours/mn poulie n° de r.p.m. polea pequeña	Diametro Diameter Durchmesser Diamètre Diámetro (mm)	N° denti N° teeth Anzahl der Zähne Nombre de dents N° de dientes
<b>T 2,5</b>	≤ 800	9,00	12
	800 - 1000	9,00	12
	1000 - 2000	10,60	14
	2000 - 3500	12,20	16
	>3500	13,80	18
<b>T 5</b>	≤ 800	15,05	10
	800 - 1000	18,25	12
	1000 - 2000	21,45	14
	2000 - 3500	24,60	16
	>3500	31,00	20
<b>T 10</b>	≤ 800	36,35	12
	800 - 1000	49,05	16
	1000 - 2000	55,45	18
	2000 - 3500	61,80	20
	>3500	68,15	22
<b>T 20</b>	≤ 800	99,00	16
	800 - 1000	124,50	20
	1000 - 2000	149,95	24
	2000 - 3500	175,40	28

**TABELLA / TABLE / TABELLE / TABLEAU / TABLA N. 5**

**Minimo n. di denti in funzione del numero al giri**  
Minimum number of cogs as a function of RPMs  
Mindestanzahl der Zähne in Abhängigkeit zur Zahl der Umdrehungen  
Nombre minimum de dents en fonction du nombre de tours  
Número mínimo de dientes en función del número de revoluciones

Tipo di cinghia Type of belt Riemenbreite Type de courroie Tipo de correa	Numero giri al 1' RPMs Umdrehungen pro Sek Nombre de tours/mn n° de r.p.m.	Valori minimi Minimal values Mindestwerte Valeurs minimales Valores mínimos	
		Ø prim. mm	N° denti
<b>XL</b>	3000	19,40	12
	1500	17,79	11
	1000	16,17	10
<b>L</b>	3000	48,51	16
	1500	42,45	14
	1000	36,38	12
<b>H</b>	3000	80,85	20
	1500	72,77	18
	1000	64,68	16
<b>XH</b>	1500	183,94	26
	1000	169,79	24
	750	155,64	22
<b>XXH</b>	1500	262,76	26
	1000	242,55	24
	750	222,34	22

**TABELLA / TABLE / TABELLE / TABLEAU / TABLA N. 6**
**Coefficiente larghezza cinghia CL / CL belt width coefficient  
Faktor Riemenbreite CL / Coefficient largeur de courroie CL  
Coeficiente ancho correa CL**

Tipo / Type / Typ / Type / Tipo <b>T 2,5</b>	
Coeff. largh. CL / CL width coefficient Breitenfaktor CL / Coeff. largeur CL Coef. ancho CL	Largh. cinghia (mm) / Belt width (mm) Riemenbreite (mm) / Largeur courroie (mm) Ancho correa (mm)
≤ 0,28	6
0,25 - 0,50	8
0,50 - 0,72	10
0,72 - 1,00	12
1,00 - 1,27	16
1,27 - 1,75	20
1,75 - 2,84	25
2,84 - 3,69	32

Tipo / Type / Typ / Type / Tipo <b>T5 - T10</b>	
Coeff. largh. CL / CL width coefficient Breitenfaktor CL / Coeff. largeur CL Coef. ancho CL	Largh. cinghia (mm) / Belt width (mm) Riemenbreite (mm) / Largeur courroie (mm) Ancho correa (mm)
0,25 - 0,50	6
0,50 - 0,72	8
0,72 - 1,00	10
1,00 - 1,27	12
1,27 - 1,75	16
1,75 - 2,23	20
2,23 - 2,84	25
2,84 - 3,69	32
3,69 - 5,86	50

Tipo / Type / Typ / Type / Tipo <b>T 20</b>	
Coeff. largh. CL / CL width coefficient Breitenfaktor CL / Coeff. largeur CL Coef. ancho CL	Largh. cinghia (mm) / Belt width (mm) Riemenbreite (mm) / Largeur courroie (mm) Ancho correa (mm)
1,7 - 2,2	20
2,2 - 2,7	25
2,7 - 3,5	32
4,0 - 6,0	50
6,0 - 9,5	75
9,5 - 11,0	100

**TABELLA / TABLE / TABELLE / TABLEAU / TABLA N. 7**
**Coefficiente di larghezza CL / CL width coefficient  
Breitenfaktor CL / Coefficient de largeur CL / Coeficiente de ancho CL**

Larghezza cinghia Lc / Belt width Lc Riemenbreite Lc / Largeur de la courroie Lc Ancho correa Lc		Coefficiente di larghezza Width coefficient Breitenfaktor Coefficient de largeur Coeficiente de ancho
mm	pollici/inches/Zoll/ pouces/pulgadas	<b>CL</b>
6,4	1/4	0,18
7,9	5/16	0,23
9,5	3/8	0,30
11,1	7/16	0,37
12,7	1/2	0,45
15,9	5/8	0,60
19,1	3/4	0,72
22,2	7/8	0,87
25,4	1"	1,02
31,8	1" 1/4	1,31
38,1	1" 1/2	1,58
44,5	1" 3/4	1,87
50,8	2"	2,17
63,5	2" 1/2	2,77
76,2	3"	3,41
88,9	3" 1/2	4,16
101,6	4"	4,84
127,0	5"	6,25
152,4	6"	7,68
177,8	7"	9,16
203,2	8"	10,67
228,6	9"	12,19
254,0	10"	13,77

Le cinghie in grassetto sono di normale produzione, le altre sono fornibili a richiesta.

Belts appearing in bold print are standard production; the others are available on request.

Die in Fettdruck aufgeführten Riemen gehören zur Standardproduktion; alle anderen Riementypen sind auf Sonderbestellung lieferbar.

Les courroies en gras font partie de la production courante; les autres peuvent être fournies à la demande.

Las correas indicadas en negrita corresponden a la producción normal; las otras pueden ser suministradas bajo pedido.

**TABELLA N. 8**  
**Coefficiente correttivo Cc**  
**in funzione del numero di**  
**denti in presa**

Quando il numero dei denti in presa tra la cinghia e la puleggia di diametro minore è inferiore a 6, la prestazione base deve essere moltiplicata per il coefficiente correttivo Cc riportato nella tabella n. 8.  
La condizione suddetta si verifica spesso quando la puleggia minore viene scelta con basso numero di denti. In caso di dubbio rivolgetevi al nostro servizio tecnico.

**TABLA N. 8**  
**Correction coefficient Cc**  
**as a function of number of**  
**engaged teeth**

When the number of teeth engaged between the belt and the smaller-diameter pulley is less than 6, base performance must be multiplied by the correction coefficient Cc reported in Table 8. This condition of ten occurs when the smaller pulley chosen has a low number of teeth. In case of doubt, contact our technical service staff.

**TABELLE Nr. 8**  
**Korrekturfaktor Cc in Ab-**  
**hängigkeit zur Anzahl der**  
**benutzten Zähne**

Ist die Anzahl der benutzten Zähne zwischen dem Riemen und der kleineren Riemenscheibe kleiner als 6, so muß die Standardleistung mit dem in der Tabelle Nr. 8 aufgeführten Korrekturfaktor (Cc) korrigiert werden.  
Dieser Fall tritt insbesondere dann auf, wenn eine kleinere Riemenscheibe mit wenigen Zähnen gewählt wird. Wenden Sie sich im Zweifelsfall an unseren Technischen Kundendienst.

**TABLEAU N. 8**  
**Coefficient correcteur Cc**  
**en fonction du nombre de**  
**dents en prise**

Lorsque le nombre de dents en prise entre la courroie et la poulie de diamètre plus petit est inférieur à 6, la prestation de base doit être multipliée par le coefficient correcteur (Cc) figurant dans le tableau n° 8.  
Le cas de figure ci-dessus se présente souvent lorsque la poulie plus petite qui a été choisie a un faible nombre de dents. En cas de doute, s'adresser à notre service technique.

**TABLA N. 8**  
**Coefficiente correctivo Cc**  
**en función del número de**  
**dientes en toma**

Quando el número de dientes en toma entre la correa y la polea de diámetro menor es inferior a 6, la prestación base debe ser multiplicada por el coeficiente correctivo (Cc) que aparece en la tabla n° 8.  
Esta situación se verifica con frecuencia cuando se elige una polea menor con número reducido de dientes. En caso de dudas, sírvase tomar contacto con nuestro servicio técnico.

Numero dei denti in presa / Number of teeth engaged Anzahl der benutzten Zähne / Nombre de dents en prise / Número de dientes en toma	<b>Cc</b> Coefficiente correttivo / Correction coefficient Cc Korrekturfaktor / Coefficient correcteur / Coeficiente correctivo
6 o più	1,00
5	0,80
4	0,60
3	0,40
2	0,20

**TABELLA N. 9**  
**Fattori di lunghezza**  
**sviluppo cinghie\***

<b>HTD® 3</b>		<b>Ff</b>
Sviluppo / Length / Länge Développement / Desarrollo		
fino a up to bis zu jusqu' à hasta	190	0,80
da from von de entre	a to bis à y	260 0,90
da from von de entre	a to bis à y	400 1,00
da from von de entre	a to bis à y	599 1,10
oltre over über supérieur mas de	600	1,20

**TABLA N. 9**  
**Belt length allowance**  
**factors\***

<b>HTD® 5</b>		<b>Ff</b>
Sviluppo / Length / Länge Développement / Desarrollo		
fino a up to bis zu jusqu' à hasta	440	0,80
da from von de entre	a to bis à y	550 0,90
da from von de entre	a to bis à y	800 1,00
da from von de entre	a to bis à y	1100 1,10
oltre over über supérieur mas de	1100	1,20

**TABELLE Nr. 9**  
**Faktor der maximal zulässi-**  
**gen Riemenlänge\***

<b>HTD® 8</b>		<b>Ff</b>
Sviluppo / Length / Länge Développement / Desarrollo		
da from von de entre	a to bis à y	600 0,80
da from von de entre	a to bis à y	880 0,90
da from von de entre	a to bis à y	1200 1,00
da from von de entre	a to bis à y	1760 1,10
da from von de entre	a to bis à y	2800 1,20

**TABLEAU N. 9**  
**Facteurs de longueur**  
**développement des**  
**courroies\***

<b>HTD® 14</b>		<b>Ff</b>
Sviluppo / Length / Länge Développement / Desarrollo		
da from von de entre	a to bis à y	1190 0,80
da from von de entre	a to bis à y	1610 0,90
da from von de entre	a to bis à y	1890 0,95
da from von de entre	a to bis à y	2450 1,00
da from von de entre	a to bis à y	3150 1,05
da from von de entre	a to bis à y	4578 1,10

**TABLA N. 9**  
**Factores de longitud**  
**desarrollo correas\***

<b>HTD® 20</b>		<b>Ff</b>
Sviluppo / Length / Länge Développement / Desarrollo		
fino a up to bis zu jusqu' à hasta	3000	0,90
da from von de entre	a to bis à y	3400 0,95
da from von de entre	a to bis à y	4600 1,00
da from von de entre	a to bis à y	5400 1,05
da from von de entre	a to bis à y	6400 1,10

\* Il valore Lf dovrà essere moltiplicato per il valore di Pb ricavato dalle tabelle 11/1-2-3-4-5.

\* The Lf value must be multiplied by the Pb value found in tables 11/1-2-3-4-5.

\* Der Wert Lf muß mit dem Wert Pb multipliziert werden, den Sie aus den Tabellen Nr. 11/1-2-3-4-5 entnehmen können.

\* La valeur Lf devra être multipliée par la valeur de Pb extraite de tableaux n° 11/1-2-3-4-5.

\* El valor Lf deberá ser multiplicado por el valor de Pb indicado en las tablas n° 11/1-2-3-4-5.

## Prestazioni base cinghie XL (Pb) / XL (Pb) Basic belt performance Standardleistungen der Riemen XL (Pb) / Prestations de base des courroies XL (Pb) Prestaciones base correas XL (Pb)

TABELLA 10/1 (Valori per 1" di larghezza) - kW	TABLE 10/1 (Values per 1" of width) - kW		TABELLE 10/1 (Werte für 1" - Breite) - kW			TABLEAU 10/1 (Valeurs pour 1" de largeur) - kW				TABLA 10/1 (Valores para 1" de ancho) - kW				
N. denti / N. of teeth / Zähnezahl N.bre de dents / Cantidad de dientes	10	11	12	14	15	16	18	20	21	22	24	28	30	32
100	0,02	0,02	0,02	0,02	0,02	0,02	0,03	0,03	0,03	0,03	0,04	0,04	0,05	0,05
200	0,03	0,03	0,04	0,04	0,05	0,05	0,05	0,06	0,06	0,07	0,07	0,09	0,09	0,10
300	0,05	0,05	0,05	0,06	0,07	0,07	0,08	0,09	0,10	0,10	0,11	0,13	0,14	0,15
400	0,06	0,07	0,07	0,09	0,09	0,10	0,11	0,12	0,13	0,13	0,15	0,17	0,18	0,19
500	0,08	0,08	0,09	0,11	0,11	0,12	0,14	0,15	0,16	0,17	0,18	0,21	0,23	0,24
600	0,09	0,10	0,11	0,13	0,14	0,15	0,16	0,18	0,19	0,20	0,22	0,26	0,27	0,29
<b>725</b>	<b>0,11</b>	<b>0,12</b>	<b>0,13</b>	<b>0,15</b>	<b>0,17</b>	<b>0,18</b>	<b>0,20</b>	<b>0,22</b>	<b>0,23</b>	<b>0,24</b>	<b>0,26</b>	<b>0,31</b>	<b>0,33</b>	<b>0,35</b>
800	0,12	0,13	0,15	0,17	0,18	0,19	0,22	0,24	0,26	0,27	0,29	0,34	0,36	0,39
900	0,14	0,15	0,16	0,19	0,21	0,22	0,25	0,27	0,29	0,30	0,33	0,38	0,41	0,44
<b>950</b>	<b>0,14</b>	<b>0,16</b>	<b>0,17</b>	<b>0,20</b>	<b>0,22</b>	<b>0,23</b>	<b>0,26</b>	<b>0,29</b>	<b>0,30</b>	<b>0,32</b>	<b>0,35</b>	<b>0,40</b>	<b>0,43</b>	<b>0,46</b>
1000	0,15	0,17	0,18	0,21	0,23	0,24	0,27	0,30	0,32	0,33	0,36	0,43	0,46	0,49
1100	0,17	0,18	0,20	0,23	0,25	0,27	0,30	0,33	0,35	0,37	0,40	0,47	0,50	0,53
1200	0,18	0,20	0,22	0,26	0,27	0,29	0,33	0,36	0,38	0,40	0,44	0,51	0,55	0,58
1300	0,20	0,22	0,24	0,28	0,30	0,32	0,36	0,39	0,41	0,43	0,47	0,55	0,59	0,63
1400	0,21	0,23	0,26	0,30	0,32	0,34	0,38	0,43	0,45	0,47	0,51	0,59	0,64	0,68
<b>1425</b>	<b>0,22</b>	<b>0,24</b>	<b>0,26</b>	<b>0,30</b>	<b>0,32</b>	<b>0,35</b>	<b>0,39</b>	<b>0,43</b>	<b>0,45</b>	<b>0,48</b>	<b>0,52</b>	<b>0,60</b>	<b>0,65</b>	<b>0,69</b>
1500	0,23	0,25	0,27	0,32	0,34	0,36	0,41	0,46	0,48	0,50	0,55	0,64	0,68	0,73
1600	0,24	0,27	0,29	0,34	0,36	0,39	0,44	0,49	0,51	0,53	0,58	0,68	0,73	0,77
1700	0,26	0,28	0,31	0,36	0,39	0,41	0,46	0,52	0,54	0,57	0,62	0,72	0,77	0,82
1800	0,27	0,30	0,33	0,38	0,41	0,44	0,49	0,55	0,57	0,60	0,65	0,76	0,82	0,87
1900	0,29	0,32	0,35	0,40	0,43	0,46	0,52	0,58	0,60	0,63	0,69	0,80	0,86	0,92
2000	0,30	0,33	0,36	0,43	0,46	0,49	0,55	0,61	0,64	0,67	0,73	0,84	0,90	0,96
2200	0,33	0,37	0,40	0,47	0,50	0,53	0,60	0,67	0,70	0,73	0,80	0,93	0,99	1,06
2400	0,36	0,40	0,44	0,51	0,55	0,58	0,65	0,73	0,76	0,80	0,87	1,01	1,08	1,15
2600	0,39	0,43	0,47	0,55	0,59	0,63	0,71	0,79	0,82	0,86	0,94	1,09	1,17	1,24
2800	0,43	0,47	0,51	0,59	0,64	0,68	0,76	0,84	0,89	0,93	1,01	1,17	1,25	1,33
<b>2850</b>	<b>0,43</b>	<b>0,48</b>	<b>0,52</b>	<b>0,60</b>	<b>0,65</b>	<b>0,69</b>	<b>0,78</b>	<b>0,86</b>	<b>0,90</b>	<b>0,94</b>	<b>1,03</b>	<b>1,19</b>	<b>1,28</b>	<b>1,36</b>
3000	0,46	0,50	0,55	0,64	0,68	0,73	0,82	0,90	0,95	0,99	1,08	1,25	1,34	1,42
3200	0,49	0,53	0,58	0,68	0,73	0,77	0,87	0,96	1,01	1,06	1,15	1,33	1,42	1,51
3400	0,52	0,57	0,62	0,72	0,77	0,82	0,92	1,02	1,07	1,12	1,22	1,41	1,51	1,60
3600	0,55	0,60	0,65	0,76	0,82	0,87	0,97	1,08	1,13	1,18	1,29	1,49	1,59	1,69
3800	0,58	0,63	0,69	0,80	0,86	0,92	1,03	1,14	1,19	1,25	1,36	1,57	1,67	1,78
4000	0,61	0,67	0,73	0,84	0,90	0,96	1,08	1,20	1,25	1,31	1,42	1,65	1,76	1,86
4200	0,64	0,70	0,76	0,89	0,95	1,01	1,13	1,25	1,31	1,37	1,49	1,72	1,84	1,95
4400	0,67	0,73	0,80	0,93	0,99	1,06	1,18	1,31	1,37	1,44	1,56	1,80	1,91	2,03
4600	0,70	0,76	0,83	0,97	1,04	1,10	1,24	1,37	1,43	1,50	1,63	1,87	1,99	2,11
4800	0,73	0,80	0,87	1,01	1,08	1,15	1,29	1,42	1,49	1,56	1,69	1,95	2,07	2,19
5000	0,76	0,83	0,90	1,05	1,12	1,20	1,34	1,48	1,55	1,62	1,76	2,02	2,15	2,27
5200	0,79	0,86	0,94	1,09	1,17	1,24	1,39	1,54	1,61	1,68	1,82	2,09	2,22	2,34
5400	0,82	0,90	0,97	1,13	1,21	1,29	1,44	1,59	1,67	1,74	1,88	2,16	2,29	2,42
5600	0,84	0,93	1,01	1,17	1,25	1,33	1,49	1,65	1,72	1,80	1,95	2,23	2,36	2,49
5800	0,87	0,96	1,05	1,21	1,30	1,38	1,54	1,70	1,78	1,86	2,01	2,30	2,43	2,56
6000	0,90	0,99	1,08	1,25	1,34	1,42	1,59	1,76	1,84	1,91	2,07	2,36	2,50	2,63
6500	0,98	1,07	1,17	1,35	1,45	1,54	1,72	1,89	1,97	2,06	2,22	2,52	2,67	2,80
7000	1,05	1,15	1,25	1,45	1,55	1,65	1,84	2,02	2,11	2,19	2,36	2,68	2,82	2,95
7500	1,12	1,23	1,34	1,55	1,65	1,76	1,95	2,15	2,24	2,33	2,50	2,82	2,96	3,09
8000	1,20	1,31	1,42	1,65	1,76	1,86	2,07	2,27	2,36	2,46	2,63	2,95	3,09	3,21
8500	1,27	1,39	1,51	1,74	1,86	1,97	2,18	2,39	2,48	2,58	2,76	3,07	3,21	3,32
9000	1,34	1,47	1,59	1,84	1,95	2,07	2,29	2,50	2,60	2,70	2,88	3,18	3,31	3,41
9500	1,41	1,54	1,67	1,93	2,05	2,17	2,40	2,61	2,71	2,81	2,99	3,28	3,40	3,48
10000	1,48	1,62	1,76	2,02	2,15	2,27	2,50	2,72	2,82	2,91	3,09	3,37	3,47	3,54
10500	1,55	1,69	1,84	2,11	2,24	2,36	2,60	2,82	2,92	3,01	3,18	3,44	3,52	3,57
11000	1,62	1,77	1,91	2,19	2,33	2,46	2,70	2,91	3,01	3,11	3,27	3,50	3,56	3,58
11500	1,69	1,84	1,99	2,28	2,42	2,55	2,79	3,01	3,10	3,19	3,35	3,54	3,58	3,57
12000	1,76	1,91	2,07	2,36	2,50	2,63	2,88	3,09	3,18	3,27	3,41	3,57	3,58	3,54
12500	1,82	1,99	2,15	2,44	2,59	2,72	2,96	3,17	3,26	3,34	3,47	3,58	3,56	3,49
13000	1,89	2,06	2,22	2,52	2,67	2,80	3,04	3,24	3,33	3,40	3,51	3,58	3,52	3,41
13500	1,95	2,13	2,29	2,60	2,74	2,88	3,11	3,31	3,39	3,45	3,55	3,56	3,46	3,30
14000	2,02	2,19	2,36	2,68	2,82	2,95	3,18	3,37	3,44	3,50	3,57	3,52	3,38	3,16
14500	2,08	2,26	2,43	2,75	2,89	3,02	3,25	3,42	3,49	3,54	3,58	3,46	3,28	3,00
15000	2,15	2,33	2,50	2,82	2,96	3,09	3,31	3,47	3,52	3,56	3,58	3,38	3,15	2,81

numero dei giri della puleggia minore / r.p.m. of smallest pulleys / Drehzahl der kleineren Reimenscheibe  
nombre de tours de la petite poulie / número de revoluciones por minuto de la polea menor

Le pulegge ed i numeri di giri corrispondenti a prestazioni comprese in quest'area possono venire impiegati solo se si accetta una riduzione di durata della cinghia.

The pulleys and RPMs corresponding to performance included in this area can be used only if a reduction in belt life is acceptable.

Die Riemenscheiben und die Anzahl der Umdrehungen, die den in diesem Bereich aufgeführten Leistungen entsprechen, können nur dann verwendet werden, wenn eine gewisse Minderung der Lebensdauer des Riemens in Kauf genommen wird.

Les poulies et les nombres de tours correspondant à des prestations comprises dans cette plage peuvent être utilisés uniquement si l'on accepte une réduction de durée de la courroie.

Las poleas y los números de revoluciones correspondientes a prestaciones comprendidas en esta área pueden ser empleadas sólo si se acepta una reducción de duración de la correa.

Per velocità superiori ai 30 m/sec., e cioè comprese in quest'area, è necessario impiegare pulegge speciali non essendo ammesso l'impiego di pulegge di serie.

For speeds of over 30 m/sec, that is, included in this area, the use of special pulleys is required; the use of standard pulleys is not possible.

Für die in diesem Bereich aufgeführten Laufgeschwindigkeiten über 30 m/s müssen Spezial-Riemenscheiben eingesetzt werden (ein Einsatz der Standard-Riemenscheiben ist nicht möglich).

Pour des vitesses supérieures à 30 m/sec. et donc comprises dans cette plage, il est nécessaire d'utiliser des poulies spéciales, l'utilisation de poulies de série n'étant pas admise.

Para velocidades superiores a 30 m/seg., esto es, comprendidas en esta área, es necesario emplear poleas especiales. En estos casos no está permitido el uso de poleas de serie.

**Prestazioni base cinghie L (Pb) / L (Pb) Basic belt performance**  
**Standardleistungen der Riemen L (Pb) / Prestations de base des courroies L (Pb)**  
**Prestaciones base correas L (Pb)**



**TABELLA 10/2** (Valori per 1" di larghezza) - kW    **TABLE 10/2** (Values per 1" of width) - kW    **TABELLE 10/2** (Werte für 1" - Breite) - kW    **TABLEAU 10/2** (Valeurs pour 1" de largeur) - kW    **TABLA 10/2** (Valores para 1" de ancho) - kW

N. denti / N. of teeth / Zähnezahl N.bre de dents / Cantidad de dientes	10	12	14	16	18	20	22	24	26	28	30	32	36	40	48
100	0,04	0,05	0,05	0,06	0,07	0,08	0,08	0,09	0,10	0,11	0,11	0,12	0,14	0,15	0,18
200	0,08	0,09	0,11	0,12	0,14	0,15	0,17	0,18	0,20	0,21	0,23	0,24	0,28	0,31	0,37
300	0,11	0,14	0,16	0,18	0,21	0,23	0,25	0,28	0,30	0,32	0,34	0,37	0,41	0,48	0,55
400	0,15	0,18	0,21	0,24	0,28	0,31	0,34	0,37	0,40	0,43	0,46	0,49	0,55	0,61	0,73
500	0,19	0,23	0,27	0,31	0,34	0,38	0,42	0,46	0,50	0,53	0,57	0,61	0,69	0,76	0,91
600	0,23	0,28	0,32	0,37	0,41	0,46	0,50	0,55	0,60	0,64	0,69	0,73	0,82	0,91	1,09
700	0,27	0,32	0,37	0,43	0,48	0,53	0,59	0,64	0,69	0,75	0,80	0,85	0,96	1,06	1,27
<b>725</b>	<b>0,28</b>	<b>0,33</b>	<b>0,39</b>	<b>0,44</b>	<b>0,50</b>	<b>0,55</b>	<b>0,61</b>	<b>0,66</b>	<b>0,72</b>	<b>0,77</b>	<b>0,83</b>	<b>0,88</b>	<b>0,99</b>	<b>1,10</b>	<b>1,32</b>
800	0,31	0,37	0,43	0,49	0,55	0,61	0,67	0,73	0,79	0,85	0,91	0,97	1,09	1,21	1,45
900	0,34	0,41	0,48	0,55	0,62	0,69	0,76	0,82	0,89	0,96	1,03	1,09	1,23	1,36	1,62
<b>950</b>	<b>0,36</b>	<b>0,44</b>	<b>0,51</b>	<b>0,58</b>	<b>0,65</b>	<b>0,72</b>	<b>0,80</b>	<b>0,87</b>	<b>0,94</b>	<b>1,01</b>	<b>1,08</b>	<b>1,15</b>	<b>1,29</b>	<b>1,43</b>	<b>1,71</b>
1000	0,38	0,46	0,53	0,61	0,69	0,76	0,84	0,91	0,99	1,06	1,14	1,21	1,36	1,51	1,80
1100	0,42	0,50	0,59	0,67	0,76	0,84	0,92	1,00	1,09	1,17	1,25	1,33	1,49	1,65	1,97
1200	0,46	0,55	0,64	0,73	0,82	0,91	1,00	1,09	1,18	1,27	1,36	1,45	1,62	1,80	2,13
1300	0,50	0,60	0,69	0,79	0,89	0,99	1,09	1,18	1,28	1,38	1,47	1,57	1,75	1,94	2,30
1400	0,53	0,64	0,75	0,85	0,96	1,06	1,17	1,27	1,38	1,48	1,58	1,68	1,88	2,08	2,46
<b>1425</b>	<b>0,54</b>	<b>0,65</b>	<b>0,76</b>	<b>0,87</b>	<b>0,98</b>	<b>1,08</b>	<b>1,19</b>	<b>1,29</b>	<b>1,40</b>	<b>1,50</b>	<b>1,61</b>	<b>1,71</b>	<b>1,91</b>	<b>2,11</b>	<b>2,50</b>
1500	0,57	0,69	0,80	0,91	1,03	1,14	1,25	1,36	1,47	1,5	1,69	1,80	2,01	2,22	2,62
1600	0,61	0,73	0,85	0,97	1,09	1,21	1,33	1,45	1,57	1,68	1,80	1,91	2,13	2,35	2,77
1700	0,65	0,78	0,91	1,03	1,16	1,29	1,41	1,54	1,66	1,78	1,90	2,02	2,26	2,48	2,92
1800	0,69	0,82	0,96	1,09	1,23	1,36	1,49	1,62	1,75	1,88	2,01	2,13	2,38	2,62	3,06
1900	0,72	0,87	1,01	1,15	1,29	1,43	1,57	1,71	1,85	1,98	2,11	2,24	2,50	2,74	3,21
2000	0,76	0,91	1,06	1,21	1,36	1,51	1,65	1,80	1,94	2,08	2,22	2,35	2,62	2,87	3,34
2200	0,84	1,00	1,17	1,33	1,49	1,65	1,81	1,97	2,12	2,27	2,42	2,56	2,84	3,11	3,60
2400	0,91	1,09	1,27	1,45	1,62	1,80	1,97	2,13	2,30	2,46	2,62	2,77	3,06	3,34	3,83
2600	0,99	1,18	1,38	1,57	1,75	1,94	2,12	2,30	2,47	2,64	2,81	2,97	3,27	3,56	4,04
2800	1,06	1,27	1,48	1,68	1,88	2,08	2,27	2,46	2,64	2,82	2,99	3,16	3,47	3,76	4,23
<b>2850</b>	<b>1,08</b>	<b>1,29</b>	<b>1,50</b>	<b>1,71</b>	<b>1,91</b>	<b>2,11</b>	<b>2,31</b>	<b>2,50</b>	<b>2,68</b>	<b>2,86</b>	<b>3,04</b>	<b>3,21</b>	<b>3,52</b>	<b>3,81</b>	<b>4,27</b>
3000	1,14	1,36	1,58	1,80	2,01	2,22	2,42	2,62	2,81	2,99	3,17	3,34	3,66	3,94	4,39
3200	1,21	1,45	1,68	1,91	2,13	2,35	2,56	2,77	2,97	3,16	3,34	3,52	3,83	4,11	4,51
3400	1,29	1,54	1,78	2,02	2,26	2,48	2,71	2,92	3,12	3,32	3,50	3,68	3,99	4,26	4,61
3600	1,36	1,62	1,88	2,13	2,38	2,62	2,84	3,06	3,27	3,47	3,66	3,83	4,14	4,39	4,67
3800	1,43	1,71	1,98	2,24	2,50	2,74	2,98	3,21	3,42	3,62	3,81	3,98	4,27	4,50	4,70
4000	1,51	1,80	2,08	2,35	2,62	2,87	3,11	3,34	3,56	3,76	3,94	4,11	4,39	4,58	4,68
4200	1,58	1,88	2,17	2,46	2,73	2,99	3,24	3,47	3,69	3,89	4,07	4,23	4,49	4,64	4,63
4400	1,65	1,97	2,27	2,56	2,84	3,11	3,36	3,60	3,81	4,01	4,19	4,34	4,57	4,68	4,53
4600	1,72	2,05	2,36	2,67	2,96	3,23	3,48	3,72	3,93	4,13	4,29	4,43	4,63	4,70	4,40
4800	1,80	2,13	2,46	2,77	3,06	3,34	3,60	3,83	4,04	4,23	4,39	4,51	4,67	4,68	4,21
5000	1,87	2,22	2,55	2,87	3,17	3,45	3,71	3,94	4,15	4,33	4,47	4,58	4,69	4,64	3,98
5200	1,94	2,30	2,64	2,97	3,27	3,56	3,81	4,04	4,24	4,41	4,54	4,63	4,69	4,57	3,69
5400	2,01	2,38	2,73	3,06	3,37	3,66	3,92	4,14	4,33	4,49	4,60	4,67	4,67	4,47	3,36
5600	2,08	2,46	2,82	3,16	3,47	3,76	4,01	4,23	4,41	4,55	4,64	4,69	4,63	4,34	2,97
5800	2,15	2,54	2,91	3,25	3,57	3,85	4,10	4,31	4,48	4,60	4,68	4,70	4,56	4,18	
6000	2,22	2,62	2,99	3,34	3,66	3,94	4,19	4,39	4,54	4,64	4,69	4,68	4,47	3,98	
6200	2,28	2,69	3,08	3,43	3,75	4,03	4,27	4,45	4,59	4,67	4,70	4,65	4,35	3,75	
6400	2,35	2,77	3,16	3,52	3,83	4,11	4,34	4,51	4,63	4,69	4,68	4,60	4,31	3,48	
6600	2,42	2,84	3,24	3,60	3,92	4,19	4,40	4,57	4,66	4,70	4,65	4,53	4,04	3,17	
6800	2,48	2,92	3,32	3,68	3,99	4,26	4,46	4,61	4,69	4,69	4,61	4,45	3,84	2,83	
7000	2,55	2,99	3,40	3,76	4,07	4,33	4,52	4,64	4,70	4,67	4,55	4,34	3,62		

numero dei giri della puleggia minore / r.p.m. of smallest pulleys / Drehzahl der kleineren Reimenscheibe  
 nombre de tours de la petite poulie / número de revoluciones por minuto de la polea menor

Le pulegge ed i numeri di giri corrispondenti a prestazioni comprese in quest'area possono venire impiegati solo se si accetta una riduzione di durata della cinghia.

The pulleys and RPMs corresponding to performance included in this area can be used only if a reduction in belt life is acceptable.

Die Riemenscheiben und die Anzahl der Umdrehungen, die den in diesem Bereich aufgeführten Leistungen entsprechen, können nur dann verwendet werden, wenn eine gewisse Minderung der Lebensdauer des Riemens in Kauf genommen wird.

Les poulies et les nombres de tours correspondant à des prestations comprises dans cette plage peuvent être utilisés uniquement si l'on accepte une réduction de durée de la courroie.

Las poleas y los números de revoluciones correspondientes a prestaciones comprendidas en esta área pueden ser empleadas sólo si se acepta una reducción de duración de la correa.

Per velocità superiori ai 30 m/sec., e cioè comprese in quest'area, è necessario impiegare pulegge speciali non essendo ammesso l'impiego di pulegge di serie.

For speeds of over 30 m/sec, that is, included in this area, the use of special pulleys is required; the use of standard pulleys is not possible.

Für die in diesem Bereich aufgeführten Laufgeschwindigkeiten über 30 m/s müssen Spezial-Riemenscheiben eingesetzt werden (ein Einsatz der Standard-Riemenscheiben ist nicht möglich).

Pour des vitesses supérieures à 30 m/sec. et donc comprises dans cette plage, il est nécessaire d'utiliser des poulies spéciales, l'utilisation de poulies de série n'étant pas admise.

Para velocidades superiores a 30 m/seg., esto es, comprendidas en esta área, es necesario emplear poleas especiales. En estos casos no está permitido el uso de poleas de serie.

## Prestazioni base cinghie H (Pb) / H (Pb) Basic belt performance Standardleistungen der Riemen H (Pb) / Prestations de base des courroies H (Pb) Prestaciones base correas H (Pb)

**TABELLA 10/3**      **TABLE 10/3**      **TABELLE 10/3**      **TABLEAU 10/3**      **TABLA 10/3**  
(Valori per 1" di larghezza) - kW      (Values per 1" of width) - kW      (Werte für 1" - Breite) - kW      (Valeurs pour 1" de largeur) - kW      (Valores para 1" de ancho) - kW

N. denti / N. of teeth / Zähnezahl N.bre de dents / Cantidad de dientes	14	16	18	20	22	24	26	28	30	32	36	40	48
100	0,18	0,21	0,23	0,26	0,29	0,31	0,34	0,36	0,39	0,42	0,47	0,52	0,62
200	0,36	0,42	0,47	0,52	0,57	0,62	0,68	0,73	0,78	0,83	0,93	1,04	1,25
300	0,55	0,62	0,70	0,78	0,86	0,93	1,01	1,09	1,17	1,25	1,40	1,56	1,87
400	0,73	0,83	0,93	1,04	1,14	1,25	1,35	1,45	1,56	1,66	1,87	2,07	2,49
500	0,91	1,04	1,17	1,30	1,43	1,56	1,69	1,82	1,94	2,07	2,33	2,59	3,10
600	1,09	1,25	1,40	1,56	1,71	1,87	2,02	2,18	2,33	2,49	2,79	3,10	3,71
700	1,27	1,45	1,63	1,82	2,00	2,18	2,36	2,54	2,72	2,90	3,25	3,61	4,32
<b>725</b>	<b>1,32</b>	<b>1,51</b>	<b>1,69</b>	<b>1,88</b>	<b>2,07</b>	<b>2,25</b>	<b>2,44</b>	<b>2,63</b>	<b>2,81</b>	<b>3,00</b>	<b>3,37</b>	<b>3,74</b>	<b>4,47</b>
800	1,45	1,66	1,87	2,07	2,28	2,49	2,69	2,90	3,10	3,31	3,71	4,12	4,92
900	1,63	1,87	2,10	2,33	2,56	2,79	3,02	3,25	3,48	3,71	4,17	4,62	5,51
<b>950</b>	<b>1,72</b>	<b>1,97</b>	<b>2,22</b>	<b>2,46</b>	<b>2,70</b>	<b>2,95</b>	<b>3,19</b>	<b>3,43</b>	<b>3,67</b>	<b>3,91</b>	<b>4,39</b>	<b>4,87</b>	<b>5,81</b>
1000	1,82	2,07	2,33	2,59	2,84	3,10	3,36	3,61	3,86	4,12	4,62	5,12	6,10
1100	2,00	2,28	2,56	2,84	3,13	3,41	3,69	3,97	4,24	4,52	5,07	5,61	6,68
1200	2,18	2,49	2,79	3,10	3,41	3,71	4,02	4,32	4,62	4,92	5,51	6,10	7,25
1300	2,36	2,69	3,02	3,36	3,69	4,02	4,34	4,67	4,99	5,31	5,95	6,58	7,80
1400	2,54	2,90	3,25	3,61	3,97	4,32	4,67	5,02	5,36	5,71	6,39	7,06	8,35
<b>1425</b>	<b>2,58</b>	<b>2,95</b>	<b>3,31</b>	<b>3,67</b>	<b>4,03</b>	<b>4,39</b>	<b>4,75</b>	<b>5,10</b>	<b>5,46</b>	<b>5,81</b>	<b>6,50</b>	<b>7,17</b>	<b>8,49</b>
1500	2,72	3,10	3,48	3,86	4,24	4,62	4,99	5,36	5,73	6,10	6,82	7,53	8,89
1600	2,90	3,31	3,71	4,12	4,52	4,92	5,31	5,71	6,10	6,48	7,25	7,99	9,41
1700	3,08	3,51	3,94	4,37	4,79	5,22	5,63	6,05	6,46	6,87	7,67	8,44	9,92
1800	3,25	3,71	4,17	4,62	5,07	5,51	5,95	6,39	6,82	7,25	8,08	8,89	10,42
1900	3,43	3,91	4,39	4,87	5,34	5,81	6,27	6,72	7,17	7,62	8,49	9,33	10,90
2000	3,61	4,12	4,62	5,12	5,61	6,10	6,58	7,06	7,53	7,99	8,89	9,76	11,37
2200	3,97	4,52	5,07	5,61	6,15	6,68	7,20	7,71	8,22	8,71	9,67	10,58	12,25
2400	4,32	4,92	5,51	6,10	6,68	7,25	7,80	8,35	8,89	9,41	10,42	11,37	13,06
2600	4,67	5,31	5,95	6,58	7,20	7,80	8,40	8,98	9,54	10,09	11,14	12,11	13,79
2800	5,02	5,71	6,39	7,06	7,71	8,35	8,98	9,59	10,17	10,74	11,82	12,80	14,44
<b>2850</b>	<b>5,10</b>	<b>5,81</b>	<b>6,50</b>	<b>7,17</b>	<b>7,84</b>	<b>8,49</b>	<b>9,12</b>	<b>9,73</b>	<b>10,33</b>	<b>10,90</b>	<b>11,98</b>	<b>12,96</b>	<b>14,58</b>
3000	5,36	6,10	6,82	7,53	8,22	8,89	9,54	10,17	10,78	11,37	12,46	13,44	14,99
3200	5,71	6,48	7,25	7,99	8,71	9,41	10,09	10,74	11,37	11,97	13,06	14,02	15,44
3400	6,05	6,87	7,67	8,44	9,20	9,92	10,62	11,29	11,93	12,53	13,62	14,54	15,79
3600	6,39	7,25	8,08	8,89	9,67	10,42	11,14	11,82	12,46	13,06	14,13	14,99	16,02
3800	6,72	7,62	8,49	9,33	10,13	10,90	11,63	12,32	12,96	13,56	14,58	15,37	16,14
4000	7,06	7,99	8,89	9,76	10,58	11,37	12,11	12,80	13,44	14,02	14,99	15,68	16,13
4200	7,39	8,35	9,28	10,17	11,02	11,82	12,56	13,25	13,88	14,44	15,34	15,92	15,98
4400	7,71	8,71	9,67	10,58	11,45	12,25	13,00	13,68	14,28	14,82	15,63	16,07	15,70
4600	8,03	9,07	10,05	10,98	11,86	12,67	13,41	14,07	14,65	15,15	15,86	16,14	16,28
4800	8,35	9,41	10,42	11,37	12,25	13,06	13,79	14,44	14,99	15,44	16,02	16,13	14,70
5000	8,67	9,76	10,78	11,75	12,63	13,44	14,15	14,77	15,28	15,68	16,12	16,02	13,96
5200	8,98	10,09	11,14	12,11	13,00	13,79	14,49	15,07	15,54	15,88	16,15	15,81	13,05
5400	9,28	10,42	11,48	12,46	13,35	14,13	14,79	15,34	15,75	16,02	16,10	15,51	11,98
5600	9,59	10,74	11,82	12,80	13,68	14,44	15,07	15,57	15,92	16,11	15,98	16,10	10,73
5800	9,88	11,06	12,15	13,13	13,99	14,72	15,32	15,76	16,04	16,15	15,79	14,58	
6000	10,17	11,37	12,46	13,44	14,28	14,99	15,54	15,92	16,12	16,13	15,51	13,96	

numero dei giri della puleggia minore / r.p.m. of smallest pulleys / Drehzahl der kleineren Reimenscheibe  
nombre de tours de la petite poulie / número de revoluciones por minuto de la polea menor

Le pulegge ed i numeri di giri corrispondenti a prestazioni comprese in quest'area possono venire impiegati solo se si accetta una riduzione di durata della cinghia.

The pulleys and RPMs corresponding to performance included in this area can be used only if a reduction in belt life is acceptable.

Die Riemenscheiben und die Anzahl der Umdrehungen, die den in diesem Bereich aufgeführten Leistungen entsprechen, können nur dann verwendet werden, wenn eine gewisse Minderung der Lebensdauer des Riemens in Kauf genommen wird.

Les poulies et les nombres de tours correspondant à des prestations comprises dans cette plage peuvent être utilisés uniquement si l'on accepte une réduction de durée de la courroie.

Las poleas y los números de revoluciones correspondientes a prestaciones comprendidas en esta área pueden ser empleadas sólo si se acepta una reducción de duración de la correa.

Per velocità superiori ai 30 m/sec., e cioè comprese in quest'area, è necessario impiegare pulegge speciali non essendo ammesso l'impiego di pulegge di serie.

For speeds of over 30 m/sec, that is, included in this area, the use of special pulleys is required; the use of standard pulleys is not possible.

Für die in diesem Bereich aufgeführten Laufgeschwindigkeiten über 30 m/s müssen Spezial-Riemenscheiben eingesetzt werden (ein Einsatz der Standard- Riemenscheiben ist nicht möglich).

Pour des vitesses supérieures à 30 m/sec. et donc comprise dans cette plage, il est nécessaire d'utiliser des poulies spéciales, l'utilisation de poulies de série n'étant pas admise.

Para velocidades superiores a 30 m/seg., esto es, comprendidas en esta área, es necesario emplear poleas especiales. En estos casos no está permitido el uso de poleas de serie.

# Prestazioni base cinghie XH (Pb) / XH (Pb) Basic belt performance

## Standardleistungen der Riemen XH (Pb) / Prestations de base des courroies XH (Pb)

### Prestaciones base correas XH (Pb)



**TABELLA 10/4** (Valori per 1" di larghezza) - kW    **TABLE 10/4** (Values per 1" of width) - kW    **TABELLE 10/4** (Werte für 1" - Breite) - kW    **TABLEAU 10/4** (Valeurs pour 1" de largeur) - kW    **TABLA 10/4** (Valores para 1" de ancho) - kW

N. denti / N. of teeth / Zähnezahl N.bre de dents / Cantidad de dientes	18	20	22	24	26	28	30	32	34	36	40
100	0,56	0,62	0,68	0,74	0,81	0,87	0,93	0,99	1,05	1,12	1,24
200	1,12	1,24	1,36	1,49	1,61	1,73	1,86	1,98	2,10	2,23	2,47
300	1,67	1,86	2,04	2,23	2,41	2,60	2,78	2,96	3,15	3,33	3,70
400	2,23	2,47	2,72	2,96	3,21	3,45	3,70	3,94	4,18	4,42	4,90
500	2,78	3,09	3,39	3,70	4,00	4,30	4,60	4,90	5,20	5,49	6,08
600	3,33	3,70	4,06	4,42	4,78	5,14	5,49	5,84	6,20	6,54	7,23
700	3,88	4,30	4,72	5,14	5,55	5,96	6,37	6,77	7,17	7,57	8,34
<b>725</b>	<b>4,01</b>	<b>4,45</b>	<b>4,88</b>	<b>5,31</b>	<b>5,74</b>	<b>6,17</b>	<b>6,59</b>	<b>7,00</b>	<b>7,41</b>	<b>7,82</b>	<b>8,61</b>
800	4,42	4,90	5,37	5,84	6,31	6,77	7,23	7,68	8,12	8,56	9,41
900	4,96	5,49	6,02	6,54	7,06	7,57	8,07	8,56	9,04	9,52	10,44
<b>950</b>	<b>5,23</b>	<b>5,79</b>	<b>6,34</b>	<b>6,89</b>	<b>7,43</b>	<b>7,96</b>	<b>8,48</b>	<b>8,99</b>	<b>9,49</b>	<b>9,98</b>	<b>10,93</b>
1000	5,49	6,08	6,66	7,23	7,79	8,34	8,88	9,41	9,93	10,44	11,41
1100	6,02	6,66	7,28	7,90	8,51	9,10	9,67	10,24	10,78	11,31	12,32
1200	6,54	7,23	7,90	8,56	9,20	9,83	10,44	11,03	11,59	12,14	13,16
1300	7,06	7,79	8,51	9,20	9,88	10,54	11,17	11,78	12,36	12,92	13,93
1400	7,57	8,34	9,10	9,83	10,54	11,22	11,87	12,49	13,08	13,63	14,63
<b>1425</b>	<b>7,69</b>	<b>8,48</b>	<b>9,24</b>	<b>9,98</b>	<b>10,70</b>	<b>11,38</b>	<b>12,04</b>	<b>12,66</b>	<b>13,25</b>	<b>13,80</b>	<b>14,79</b>
1500	8,07	8,88	9,67	10,44	11,17	11,87	12,53	13,16	13,75	14,29	15,24
1600	8,56	9,41	10,24	11,03	11,78	12,49	13,16	13,78	14,36	14,88	15,76
1700	9,04	9,93	10,78	11,59	12,36	13,08	13,75	14,36	14,91	15,40	16,18
1800	9,52	10,44	11,31	12,14	12,92	13,63	14,29	14,88	15,40	15,85	16,50
1900	9,98	10,93	11,82	12,66	13,44	14,15	14,79	15,35	15,83	16,22	16,72
2000	10,44	11,41	12,32	13,16	13,93	14,63	15,24	15,76	16,18	16,50	16,82
2100	10,88	11,87	12,79	13,63	14,39	15,06	15,64	16,10	16,46	16,70	16,80
2200	11,31	12,32	13,24	14,08	14,82	15,46	15,98	16,39	16,66	16,81	16,65
2300	11,73	12,75	13,67	14,49	15,21	15,80	16,27	16,60	16,79	16,82	16,37
2400	12,14	13,16	14,08	14,88	15,56	16,10	16,50	16,75	16,82	16,72	15,96
2500	12,53	13,56	14,46	15,24	15,87	16,35	16,67	16,82	16,77	16,53	15,40
2600	12,92	13,93	14,82	15,56	16,14	16,55	16,78	16,81	16,63	16,22	14,69
2700	13,28	14,29	15,15	15,85	16,37	16,70	16,82	16,72	16,39	15,80	13,82
2800	13,63	14,63	15,46	16,10	16,55	16,79	16,80	16,56	16,05	15,27	12,79
<b>2850</b>	<b>13,80</b>	<b>14,79</b>	<b>15,60</b>	<b>16,22</b>	<b>16,63</b>	<b>16,81</b>	<b>16,76</b>	<b>16,44</b>	<b>15,84</b>	<b>14,95</b>	<b>12,22</b>
2900	13,97	14,94	15,73	16,32	16,69	16,82	16,70	16,30	15,61	14,61	
3000	14,29	15,24	15,98	16,50	16,78	16,80	18,53	15,96	15,06	13,82	
3200	14,88	15,76	16,39	16,75	16,81	16,56	15,96	14,99	16,63		
3400	15,40	16,18	16,66	16,82	16,63	16,05	15,06	13,63			
3600	15,85	16,50	16,81	16,72	16,22	15,27	13,82				
3800	16,22	16,72	16,80	16,44	15,58	14,19					
4000	16,50	16,82	16,65	15,96	14,69						
4200	16,70	16,80	16,34	15,27	13,53						
4400	16,81	16,65									
4500	16,82	16,53									

numero dei giri della puleggia minore / r.p.m. of smallest pulleys / Drehzahl der kleineren Reimerscheibe  
nombre de tours de la petite poulie / número de revoluciones por minuto de la polea menor

	Le pulegge ed i numeri di giri corrispondenti a prestazioni comprese in quest'area possono venire impiegati solo se si accetta una riduzione di durata della cinghia.		The pulleys and RPMs corresponding to performance included in this area can be used only if a reduction in belt life is acceptable.
	Per velocità superiori ai 30 m/sec., e cioè comprese in quest'area, è necessario impiegare pulegge speciali non essendo ammesso l'impiego di pulegge di serie.		For speeds of over 30 m/sec, that is, included in this area, the use of special pulleys is required; the use of standard pulleys is not possible.
	Le pulegge comprese in quest'area sono soggette ad ambedue le limitazioni di cui sopra.		The pulleys included in this area are subjects to both of the restrictions listed above.
			Die Riemenscheiben und die Anzahl der Umdrehungen, die den in diesem Bereich aufgeführten Leistungen entsprechen, können nur dann verwendet werden, wenn eine gewisse Minderung der Lebensdauer des Riemens in Kauf genommen wird.
			Für die in diesem Bereich aufgeführten Laufgeschwindigkeiten über 30 m/s müssen Spezial-Riemenscheiben eingesetzt werden (ein Einsatz der Standard- Riemenscheiben ist nicht möglich).
			Die in diesem Bereich aufgeführten Riemenscheiben unterliegen beiden o.a. Einschränkungen.
			Les poulies et les nombres de tours correspondant à des prestations comprises dans cette plage peuvent être utilisés uniquement si l'on accepte une réduction de durée de la courroie.
			Pour des vitesses supérieures à 30 m/sec. et donc comprise dans cette plage, il est nécessaire d'utiliser des poulies spéciales, l'utilisation de poulies de série n'étant pas admise.
			Las poleas y los números de revoluciones correspondientes a prestaciones comprendidas en esta área pueden ser empleadas sólo si se acepta una reducción de duración de la correa.
			Para velocidades superiores a 30 m/seg., esto es, comprendidas en esta área, es necesario emplear poleas especiales. En estos casos no está permitido el uso de poleas de serie.
			Las poleas comprendidas en esta área están sometidas a las dos limitaciones arriba indicadas.

## Prestazioni base cinghie XXH (Pb) / XXH (Pb) Basic belt performance Standardleistungen der Riemen XXH (Pb) / Prestations de base des courroies XXH (Pb) Prestaciones base correas XXH (Pb)

**TABELLA 10/5** (Valori per 1" di larghezza) - kW    **TABLE 10/5** (Values per 1" of width) - kW    **TABELLE 10/5** (Werte für 1" - Breite) - kW    **TABLEAU 10/5** (Valeurs pour 1" de largeur) - kW    **TABLA 10/5** (Valores para 1" de ancho) - kW

N. denti / N. of teeth / Zähnezahl N.bre de dents / Cantidad de dientes	18	20	22	24	26	30	34	40
100	0,98	1,09	1,19	1,30	1,41	1,63	1,84	2,17
200	1,95	2,17	2,38	2,60	2,81	3,24	3,67	4,31
300	2,92	3,24	3,57	3,89	4,21	4,84	5,47	6,41
400	9,89	4,31	4,74	5,16	5,58	6,41	7,24	8,45
500	4,84	5,37	5,89	6,41	6,93	7,94	8,94	10,39
600	5,79	6,41	7,03	7,64	8,25	9,43	10,58	12,22
700	6,72	7,44	8,15	8,84	9,53	10,86	12,13	13,91
<b>725</b>	<b>6,95</b>	<b>7,69</b>	<b>8,42</b>	<b>9,14</b>	<b>9,84</b>	<b>11,20</b>	<b>12,50</b>	<b>14,31</b>
800	7,64	8,45	9,23	10,01	10,76	12,22	13,58	15,45
900	8,54	9,43	10,29	11,13	11,95	13,50	14,93	16,80
<b>950</b>	<b>8,99</b>	<b>9,91</b>	<b>10,81</b>	<b>11,68</b>	<b>12,52</b>	<b>14,11</b>	<b>15,55</b>	<b>17,40</b>
1000	9,43	10,39	11,32	12,22	13,08	14,70	16,15	17,95
1100	10,29	11,32	12,30	13,25	14,15	15,80	17,23	18,88
1200	11,13	12,22	13,25	14,23	15,15	16,80	18,16	19,56
1300	11,95	13,08	14,15	15,15	16,08	17,69	18,92	19,97
1400	12,74	13,91	15,00	16,01	16,93	18,45	19,50	20,08
<b>1425</b>	<b>12,93</b>	<b>14,11</b>	<b>15,21</b>	<b>16,22</b>	<b>17,12</b>	<b>18,62</b>	<b>19,62</b>	<b>20,06</b>
1500	13,50	14,70	15,80	16,80	16,08	19,07	19,89	19,88
1600	14,23	15,45	16,55	17,52	18,35	19,56	20,07	19,34
1700	14,93	16,15	17,23	18,16	18,92	19,89	20,03	18,44
1800	15,59	16,80	17,85	18,71	19,38	20,06	19,75	17,15
1900	16,22	17,40	18,40	19,18	19,73	20,06	19,23	15,46
2000	16,80	17,95	18,88	19,56	19,97	19,88	18,44	13,34
2100	17,35	18,45	19,29	19,84	20,08	19,51	17,37	
2200	17,85	18,88	19,61	20,01	20,05	18,93	16,01	
2300	18,31	19,25	19,86	20,08	19,90	18,15	14,35	
2400	18,71	19,56	20,01	20,04	19,60	17,15	12,37	
2500	19,07	19,80	20,08	19,88	19,16	15,62	10,05	
2600	19,38	19,97	20,05	19,60	18,54	14,46	7,39	
2700	19,64	20,06	19,93	19,19	17,78	12,74		
2800	19,84	20,08	19,71	18,65	16,85	10,77		
<b>2850</b>	<b>19,92</b>	<b>20,06</b>	<b>19,55</b>	<b>18,33</b>	<b>16,32</b>	<b>9,69</b>		
2900	19,98	20,02	19,37	17,97	15,74	8,53		
3000	20,06	19,88	18,93	17,15	14,46	6,02		
3100	20,08	19,65	18,38	16,19	12,99	3,22		
3200	20,04	19,34	17,71	15,07	11,32			
3300	19,93	18,93	16,93	13,80	9,46			
3400	19,75	18,44	16,01	12,37	7,39			
3500	19,51	17,84	14,97	10,77				

numero dei giri della puleggia minore / r.p.m. of smallest pulleys / Drehzahl der kleineren Reimenscheibe  
nombre de tours de la petite poulie / número de revoluciones por minuto de la polea menor

- Le pulegge ed i numeri di giri corrispondenti a prestazioni comprese in quest'area possono venire impiegati solo se si accetta una riduzione di durata della cinghia.

The pulleys and RPMs corresponding to performance included in this area can be used only if a reduction in belt life is acceptable.

Die Riemenscheiben und die Anzahl der Umdrehungen, die den in diesem Bereich aufgeführten Leistungen entsprechen, können nur dann verwendet werden, wenn eine gewisse Minderung der Lebensdauer des Riemens in Kauf genommen wird.

Les poulies et les nombres de tours correspondant à des prestations comprises dans cette plage peuvent être utilisés uniquement si l'on accepte une réduction de durée de la courroie.

Las poleas y los números de revoluciones correspondientes a prestaciones comprendidas en esta área pueden ser empleadas sólo si se acepta una reducción de duración de la correa.
- Per velocità superiori ai 30 m/sec., e cioè comprese in quest'area, è necessario impiegare pulegge speciali non essendo ammesso l'impiego di pulegge di serie.

For speeds of over 30 m/sec, that is, included in this area, the use of special pulleys is required; the use of standard pulleys is not possible.

Für die in diesem Bereich aufgeführten Laufgeschwindigkeiten über 30 m/s müssen Spezial-Riemenscheiben eingesetzt werden (ein Einsatz der Standard- Riemenscheiben ist nicht möglich).

Pour des vitesses supérieures à 30 m/sec. et donc comprise dans cette plage, il est nécessaire d'utiliser des poulies spéciales, l'utilisation de poulies de série n'étant pas admise.

Para velocidades superiores a 30 m/seg., esto es, comprendidas en esta área, es necesario emplear poleas especiales. En estos casos no está permitido el uso de poleas de serie.
- Le pulegge comprese in quest'area sono soggette ad ambedue le limitazioni di cui sopra.

The pulleys included in this area are subjects to both of the restrictions listed above.

Die in diesem Bereich aufgeführten Riemenscheiben unterliegen beiden o.a. Einschränkungen.

Les poulies comprises dans cette plage sont soumises aux deux limitations mentionnées ci-dessus.

Las poleas comprendidas en esta área están sometidas a las dos limitaciones arriba indicadas.



# Prestazioni base cinghie HTD® 3M (Pb) / HTD® 3M (Pb) Basic belt performance

## Standardleistungen der Riemen HTD® 3M (Pb)

## Prestations de base des courroies HTD® 3M (Pb) / Prestaciones base correas HTD® 3M (Pb)



TABELLA 11/1 (Valori per 1" di larghezza) - kW	TABLE 11/1 (Values per 1" of width) - kW				TABELLE 11/1 (Werte für 1" - Breite) - kW				TABLEAU 11/1 (Valeurs pour 1" de largeur) - kW				TABLA 11/1 (Valores para 1" de ancho) - kW						
N. denti / N. of teeth / Zähnezahl N.bre de dents / Cantidad de dientes	10	12	14	16	18	20	22	24	26	28	32	36	40	44	48	56	64	72	80
100	0,013	0,015	0,018	0,020	0,023	0,025	0,028	0,030	0,033	0,035	0,040	0,045	0,050	0,055	0,060	0,070	0,080	0,090	0,100
200	0,025	0,030	0,035	0,040	0,045	0,050	0,055	0,060	0,065	0,070	0,080	0,090	0,100	0,110	0,120	0,140	0,160	0,180	0,200
300	0,038	0,045	0,053	0,060	0,068	0,075	0,083	0,090	0,098	0,105	0,120	0,135	0,150	0,165	0,180	0,210	0,240	0,270	0,300
400	0,050	0,060	0,070	0,080	0,090	0,100	0,110	0,120	0,130	0,140	0,160	0,180	0,200	0,220	0,240	0,280	0,320	0,360	0,400
500	0,063	0,075	0,088	0,100	0,113	0,125	0,138	0,150	0,163	0,175	0,200	0,225	0,250	0,275	0,300	0,350	0,400	0,450	0,500
600	0,075	0,090	0,105	0,120	0,135	0,150	0,165	0,180	0,195	0,210	0,240	0,270	0,300	0,330	0,360	0,420	0,480	0,540	0,600
700	0,088	0,105	0,123	0,140	0,158	0,175	0,193	0,210	0,228	0,245	0,280	0,315	0,350	0,385	0,420	0,490	0,560	0,630	0,700
800	0,100	0,120	0,140	0,160	0,180	0,200	0,220	0,240	0,260	0,280	0,320	0,360	0,400	0,440	0,480	0,560	0,640	0,720	0,800
900	0,11	0,14	0,16	0,18	0,20	0,23	0,25	0,27	0,29	0,32	0,36	0,41	0,45	0,50	0,54	0,63	0,72	0,81	0,90
1000	0,13	0,15	0,18	0,20	0,23	0,25	0,28	0,30	0,33	0,35	0,40	0,45	0,50	0,55	0,60	0,70	0,80	0,90	1,00
1100	0,14	0,17	0,19	0,22	0,25	0,28	0,30	0,33	0,36	0,39	0,44	0,50	0,55	0,61	0,66	0,77	0,88	0,99	1,10
1200	0,15	0,18	0,21	0,24	0,27	0,30	0,33	0,36	0,39	0,42	0,48	0,54	0,60	0,66	0,72	0,84	0,96	1,08	1,20
1300	0,16	0,20	0,23	0,26	0,29	0,33	0,36	0,39	0,42	0,46	0,52	0,59	0,65	0,72	0,78	0,91	1,04	1,17	1,30
1400	0,18	0,21	0,25	0,28	0,32	0,35	0,39	0,42	0,46	0,49	0,56	0,63	0,70	0,77	0,84	0,98	1,12	1,26	1,40
1500	0,19	0,23	0,26	0,30	0,34	0,38	0,41	0,45	0,49	0,53	0,60	0,68	0,75	0,83	0,90	1,05	1,20	1,35	1,50
1600	0,20	0,24	0,28	0,32	0,36	0,40	0,44	0,48	0,52	0,56	0,64	0,72	0,80	0,88	0,96	1,12	1,28	1,44	1,60
1700	0,21	0,26	0,30	0,34	0,38	0,43	0,47	0,51	0,55	0,60	0,68	0,77	0,85	0,94	1,02	1,19	1,36	1,53	1,70
1800	0,23	0,27	0,32	0,36	0,41	0,45	0,50	0,54	0,59	0,63	0,72	0,81	0,90	0,99	1,08	1,26	1,44	1,62	1,80
1900	0,24	0,29	0,33	0,38	0,43	0,48	0,52	0,57	0,62	0,67	0,76	0,86	0,95	1,05	1,14	1,33	1,52	1,71	1,90
2000	0,25	0,30	0,35	0,40	0,45	0,50	0,55	0,60	0,65	0,70	0,80	0,90	1,00	1,10	1,20	1,40	1,60	1,80	2,00
2500	0,31	0,38	0,44	0,50	0,56	0,63	0,69	0,75	0,81	0,88	1,00	1,13	1,25	1,36	1,40	1,72	1,96	2,26	2,43
3000	0,38	0,45	0,53	0,60	0,68	0,75	0,83	0,90	0,98	1,05	1,20	1,35	1,48	1,62	1,77	2,06	2,35	2,60	2,87
3500	0,44	0,53	0,61	0,70	0,79	0,88	0,96	1,05	1,14	1,23	1,40	1,56	1,72	1,88	2,06	2,38	2,70	3,00	3,29
4000	0,50	0,60	0,70	0,80	0,90	1,00	1,10	1,20	1,30	1,40	1,58	1,77	1,96	2,15	2,33	2,69	3,05	3,38	3,70
4500	0,56	0,68	0,79	0,90	1,01	1,13	1,24	1,35	1,46	1,56	1,74	1,98	2,20	2,40	2,60	3,00	3,38	3,73	4,07
5000	0,63	0,75	0,88	1,00	1,13	1,25	1,38	1,50	1,60	1,72	1,88	2,20	2,43	2,65	2,87	3,29	3,70	4,07	4,40
6000	0,75	0,90	1,05	1,20	1,35	1,50	1,63	1,77	1,91	2,05	2,33	2,60	2,87	3,13	3,38	3,85	4,28	4,64	4,97
7000	0,88	1,05	1,23	1,40	1,56	1,72	1,89	2,06	2,22	2,38	2,70	3,00	3,29	3,57	3,85	4,35	4,77	5,11	5,37
8000	1,00	1,20	1,40	1,58	1,77	1,96	2,15	2,33	2,52	2,69	3,05	3,37	3,65	3,97	4,28	4,77	5,17	5,41	5,57
9000	1,13	1,35	1,56	1,78	1,98	2,19	2,40	2,60	2,81	3,00	3,38	3,73	4,07	4,37	4,65	5,11	5,44	5,57	5,54
10000	1,24	1,48	1,72	1,96	2,19	2,42	2,65	2,87	3,08	3,29	3,69	4,07	4,40	4,71	4,87	5,37	5,57	5,54	5,28
12000	1,48	1,77	2,06	2,33	2,60	2,87	3,13	3,38	3,62	3,85	4,28	4,64	4,97	5,23	5,41	5,61	5,41	4,84	3,84
14000	1,72	2,06	2,38	2,70	3,00	3,29	3,57	3,84	4,11	4,35	4,77	5,11	5,37	5,54	5,61	5,33	4,52	3,12	1,00
16000	1,96	2,39	2,70	3,08	3,38	3,69	3,99	4,28	4,53	4,77	5,17	5,41	5,57	5,56	5,41	4,52	2,86	-	-
18000	2,20	2,60	3,00	3,38	3,73	4,07	4,37	4,64	4,89	5,11	5,41	5,57	5,54	5,38	4,84	3,12	-	-	-
20000	2,42	2,87	3,29	3,69	4,07	4,40	4,75	4,97	5,20	5,37	5,57	5,54	5,28	4,71	3,84	1,00	-	-	-

numero dei giri della puleggia minore / r.p.m. of smallest pulleys  
Drehzahl der kleineren Reimenscheibe / nombre de tours de la petite poulie  
número de revoluciones por minuto de la polea menor

Per trasmissioni che utilizzano cinghie di larghezza diversa da 25 mm, moltiplicare i valori di tabella per il fattore di larghezza cinghia.

For transmissions fitted with belts having a width different than 25 mm, multiply the values reported in the table by the belt width factor.

Für Übertragungen mit einer anderen Riemenbreite als 25 mm müssen die in der Tabelle aufgeführten Werte mit dem Faktor der Riemenbreite multipliziert werden.

Pour les transmissions qui utilisent des courroies d'une largeur autre que 25 mm, multiplier les valeurs du tableau par le facteur de largeur de la courroie.

Para transmisiones que usan correas de ancho que no sea 25 mm, multiplicar los valores de tabla por el factor de ancho correa.

### Fattori di larghezza della cinghia

### Belt width factor

### Faktor der Riemenbreite

### Facteurs de largeur de la courroie

### Factores de ancho correa

Larghezza cinghia / Belt width / Riemenbreite Largeur de la courroie / Ancho correa	3	5	6	8	9	12	15	19	22	25
Fattore moltiplicazione / Multiplication factor / Multiplikationsfaktor / Facteur de multiplication Factor multiplicación	0,09	0,14	<b>0,18</b>	0,24	<b>0,27</b>	0,41	<b>0,54</b>	0,72	0,86	<b>1,00</b>

Le pulegge ed i numeri di giri corrispondenti a prestazioni comprese in quest'area possono venire impiegati solo se si accetta una riduzione di durata della cinghia.

The pulleys and RPMs corresponding to performance included in this area can be used only if a reduction in belt life is acceptable.

Die Riemenscheiben und die Anzahl der Umdrehungen, die den in diesem Bereich aufgeführten Leistungen entsprechen, können nur dann verwendet werden, wenn eine gewisse Minderung der Lebensdauer des Riemens in Kauf genommen wird.

Les poulies et les nombres de tours correspondant à des prestations comprises dans cette plage peuvent être utilisés uniquement si l'on accepte une réduction de durée de la courroie.

Las poleas y los números de revoluciones correspondientes a prestaciones comprendidas en esta área pueden ser empleadas sólo si se acepta una reducción de duración de la correa.

Per velocità superiori ai 30 m/sec., e cioè comprese in quest'area, è necessario impiegare pulegge speciali non essendo ammesso l'impiego di pulegge di serie.

For speeds of over 30 m/sec, that is, included in this area, the use of special pulleys is required; the use of standard pulleys is not possible.

Für die in diesem Bereich aufgeführten Laufgeschwindigkeiten über 30 m/s müssen Spezial-Riemenscheiben eingesetzt werden (ein Einsatz der Standard-Riemenscheiben ist nicht möglich).

Pour des vitesses supérieures à 30 m/sec. et donc comprises dans cette plage, il est nécessaire d'utiliser des poulies spéciales, l'utilisation de poulies de série n'étant pas admise.

Para velocidades superiores a 30 m/seg., esto es, comprendidas en esta área, es necesario emplear poleas especiales. En estos casos no está permitido el uso de poleas de serie.

Le pulegge comprese in quest'area sono soggette ad ambedue le limitazioni di cui sopra.

The pulleys included in this area are subjects to both of the restrictions listed above.

Die in diesem Bereich aufgeführten Riemenscheiben unterliegen beiden o.a. Einschränkungen.

Les poulies comprises dans cette plage sont soumises aux deux limitations mentionnées ci-dessus.

Las poleas comprendidas en esta área están sometidas a las dos limitaciones arriba indicadas.

TABELLA 11/2 (Valori per 1" di larghezza) - kW	TABLE 11/2 (Values per 1" of width) - kW	TABELLE 11/2 (Werte für 1" - Breite) - kW	TABLEAU 11/2 (Valeurs pour 1" de largeur) - kW	TABLA 11/2 (Valores para 1" de ancho) - kW													
N. denti / N. of teeth / Zähnezahl N.bre de dents / Cantidad de dientes	14	16	18	20	22	24	26	28	32	36	40	44	48	56	64	72	80
10	0,004	0,005	0,006	0,006	0,007	0,008	0,008	0,009	0,010	0,011	0,013	0,014	0,015	0,018	0,020	0,023	0,025
20	0,009	0,010	0,011	0,013	0,014	0,015	0,016	0,018	0,020	0,023	0,025	0,028	0,030	0,035	0,040	0,046	0,051
40	0,018	0,020	0,023	0,025	0,028	0,030	0,033	0,036	0,040	0,046	0,051	0,056	0,061	0,071	0,081	0,091	0,101
60	0,027	0,030	0,034	0,038	0,042	0,046	0,049	0,053	0,061	0,068	0,076	0,084	0,091	0,106	0,122	0,137	0,152
100	0,044	0,051	0,057	0,063	0,070	0,076	0,082	0,089	0,101	0,114	0,127	0,139	0,152	0,177	0,203	0,228	0,253
200	0,089	0,101	0,114	0,127	0,139	0,152	0,165	0,177	0,203	0,228	0,253	0,276	0,304	0,355	0,405	0,456	0,507
300	0,133	0,151	0,171	0,190	0,209	0,228	0,247	0,266	0,304	0,342	0,380	0,418	0,456	0,532	0,608	0,684	0,760
400	0,177	0,203	0,228	0,253	0,279	0,304	0,329	0,355	0,405	0,456	0,507	0,557	0,608	0,709	0,811	0,912	1,013
500	0,222	0,253	0,285	0,317	0,348	0,380	0,412	0,443	0,507	0,570	0,633	0,700	0,760	0,887	1,013	1,140	1,267
600	0,266	0,304	0,342	0,380	0,418	0,456	0,492	0,532	0,608	0,684	0,760	0,836	0,912	1,064	1,216	1,368	1,520
700	0,310	0,355	0,399	0,443	0,487	0,532	0,576	0,621	0,709	0,798	0,886	0,975	1,064	1,241	1,418	1,596	1,773
800	0,354	0,406	0,456	0,506	0,558	0,608	0,658	0,701	0,810	0,912	1,014	1,114	1,216	1,418	1,622	1,824	2,026
900	0,40	0,45	0,51	0,57	0,63	0,68	0,74	0,80	0,91	1,03	1,14	1,25	1,37	1,59	1,82	2,05	2,28
1000	0,44	0,50	0,56	0,63	0,69	0,76	0,82	0,88	1,01	1,14	1,26	1,40	1,52	1,76	2,02	2,28	2,49
1100	0,48	0,55	0,61	0,69	0,76	0,83	0,90	0,97	1,11	1,25	1,37	1,53	1,67	1,93	2,21	2,49	2,73
1200	0,52	0,60	0,67	0,76	0,83	0,91	0,98	1,06	1,21	1,36	1,49	1,66	1,81	2,10	2,40	2,70	2,97
1300	0,57	0,65	0,72	0,82	0,89	0,98	1,06	1,14	1,31	1,47	1,61	1,79	1,95	2,27	2,59	2,91	3,21
1400	0,62	0,70	0,78	0,88	0,96	1,06	1,14	1,23	1,41	1,58	1,73	1,93	2,10	2,44	2,79	3,13	3,45
1500	0,66	0,76	0,85	0,95	1,04	1,14	1,23	1,32	1,51	1,70	1,88	2,07	2,25	2,62	2,98	3,33	3,70
1600	0,70	0,81	0,91	1,01	1,11	1,21	1,30	1,41	1,61	1,82	1,99	2,20	2,40	2,79	3,17	3,56	3,90
1700	0,75	0,85	0,96	1,07	1,18	1,28	1,39	1,49	1,71	1,92	2,11	2,34	2,55	2,95	3,36	3,76	4,14
1800	0,79	0,91	1,02	1,14	1,25	1,36	1,47	1,58	1,81	2,03	2,25	2,47	2,69	3,13	3,55	3,97	4,38
2000	0,88	0,98	1,14	1,25	1,36	1,51	1,62	1,73	1,99	2,25	2,47	2,73	2,98	3,45	3,90	4,38	4,81
2500	1,10	1,25	1,40	1,56	1,73	1,88	2,04	2,19	2,47	3,80	3,07	3,39	3,70	4,24	4,81	5,35	5,84
3000	1,33	1,50	1,70	1,85	2,07	2,25	2,43	2,62	2,98	3,34	3,70	4,08	4,38	5,09	5,66	6,24	6,80
3500	1,54	1,76	1,98	2,19	2,41	2,62	2,83	3,04	3,46	3,87	4,27	4,65	5,04	5,76	6,44	7,05	7,58
4000	1,76	2,00	2,25	2,50	2,74	2,98	3,22	3,46	3,92	4,38	4,81	5,25	5,66	6,43	7,12	7,73	8,20
4500	1,98	2,25	2,53	2,80	3,07	3,34	3,51	3,87	4,38	4,87	5,35	5,82	6,24	7,05	7,73	8,29	8,70
5000	2,19	2,50	2,80	3,11	3,40	3,70	3,98	4,27	4,81	5,35	5,84	6,34	6,80	7,57	8,19	8,70	8,95
6000	2,62	2,98	3,35	3,70	4,04	4,38	4,72	5,04	5,66	6,24	6,80	7,28	7,73	8,43	8,89	9,00	8,80
7000	3,04	3,46	3,87	4,24	4,65	5,04	5,41	5,76	6,41	7,05	7,57	8,04	8,43	8,90	8,95	8,52	7,55
8000	3,46	3,90	4,38	4,81	5,22	5,66	6,05	6,42	7,11	7,72	8,19	8,61	8,89	8,95	8,43	7,15	5,11
10000	4,24	4,81	5,35	5,84	6,33	6,80	7,19	7,57	8,19	8,70	8,95	8,97	8,80	7,55	5,11	1,20	-
12000	5,04	5,66	6,24	6,80	7,28	7,72	8,11	8,42	8,86	9,00	8,80	8,18	7,15	3,70	-	-	-

Per trasmissioni che utilizzano cinghie di larghezza diversa da 25 mm, moltiplicare i valori di tabella per il fattore di larghezza cinghia.

For transmissions fitted with belts having a width different than 25 mm, multiply the values reported in the table by the belt width factor.

Für Übertragungen mit einer anderen Riemenbreite als 25 mm müssen die in der Tabelle aufgeführten Werte mit dem Faktor der Riemenbreite multipliziert werden.

Pour les transmissions qui utilisent des courroies d'une largeur autre que 25 mm, multiplier les valeurs du tableau par le facteur de largeur de la courroie.

Para transmisiones que usan correas de ancho que no sea 25 mm, multiplicar los valores de tabla por el factor de ancho correa.

### Fattori di larghezza della cinghia

### Belt width factor

### Faktor der Riemenbreite

### Facteurs de largeur de la courroie

### Factores de ancho correa

Larghezza cinghia / Belt width / Riemenbreite Largeur de la courroie / Ancho correa	6	8	9	12	15	19	22	25	32	40	50
Fattore moltiplicazione / Multiplication factor Multiplikationsfaktor / Facteur de multiplication Factor multiplicación	0,18	0,24	<b>0,27</b>	0,41	<b>0,54</b>	0,72	0,86	<b>1,00</b>	1,32	1,69	2,14

Le pulegge ed i numeri di giri corrispondenti a prestazioni comprese in quest'area possono venire impiegati solo se si accetta una riduzione di durata della cinghia.

The pulleys and RPMs corresponding to performance included in this area can be used only if a reduction in belt life is acceptable.

Die Riemenscheiben und die Anzahl der Umdrehungen, die den in diesem Bereich aufgeführten Leistungen entsprechen, können nur dann verwendet werden, wenn eine gewisse Minderung der Lebensdauer des Riemens in Kauf genommen wird.

Les poulies et les nombres de tours correspondant à des prestations comprises dans cette plage peuvent être utilisés uniquement si l'on accepte une réduction de durée de la courroie.

Las poleas y los números de revoluciones correspondientes a prestaciones comprendidas en esta área pueden ser empleadas sólo si se acepta una reducción de duración de la correa.

Per velocità superiori ai 30 m/sec., e cioè comprese in quest'area, è necessario impiegare pulegge speciali non essendo ammesso l'impiego di pulegge di serie.

For speeds of over 30 m/sec, that is, included in this area, the use of special pulleys is required; the use of standard pulleys is not possible.

Für die in diesem Bereich aufgeführten Laufgeschwindigkeiten über 30 m/s müssen Spezial-Riemenscheiben eingesetzt werden (ein Einsatz der Standard-Riemenscheiben ist nicht möglich).

Pour des vitesses supérieures à 30 m/sec. et donc comprises dans cette plage, il est nécessaire d'utiliser des poulies spéciales, l'utilisation de poulies de série n'étant pas admise.

Para velocidades superiores a 30 m/seg., esto es, comprendidas en esta área, es necesario emplear poleas especiales. En estos casos no está permitido el uso de poleas de serie.

Le pulegge comprese in quest'area sono soggette ad ambedue le limitazioni di cui sopra.

The pulleys included in this area are subjects to both of the restrictions listed above.

Die in diesem Bereich aufgeführten Riemenscheiben unterliegen beiden o.a. Einschränkungen.

Les poulies comprises dans cette plage sont soumises aux deux limitations mentionnées ci-dessus.

Las poleas comprendidas en esta área están sometidas a las dos limitaciones arriba indicadas.

# Prestazioni base cinghie HTD® 8M (Pb) / HTD® 8M (Pb) Basic belt performance

## Standardleistungen der Riemen HTD® 8M (Pb)

## Prestations de base des courroies HTD® 8M (Pb) / Prestaciones base correas HTD® 8M (Pb)



TABELLA 11/3 (Valori per 1" di larghezza) - kW	TABLE 11/3 (Values per 1" of width) - kW				TABELLE 11/3 (Werte für 1" - Breite) - kW				TABLEAU 11/3 (Valeurs pour 1" de largeur) - kW				TABLA 11/3 (Valores para 1" de ancho) - kW				
N. denti / N. of teeth / Zähnezahl N.bre de dents / Cantidad de dientes	20	22	24	26	28	30	32	34	36	38	40	44	48	56	64	72	80
10	0,02	0,02	0,02	0,03	0,03	0,04	0,04	0,05	0,06	0,07	0,07	0,08	0,09	0,10	0,12	0,13	0,14
20	0,04	0,05	0,06	0,07	0,08	0,08	0,10	0,11	0,12	0,13	0,14	0,16	0,18	0,20	0,23	0,26	0,29
40	0,08	0,10	0,12	0,14	0,16	0,18	0,20	0,23	0,25	0,27	0,29	0,32	0,36	0,40	0,45	0,52	0,58
60	0,12	0,15	0,18	0,21	0,24	0,27	0,30	0,34	0,37	0,40	0,43	0,48	0,52	0,61	0,70	0,78	0,87
100	0,20	0,25	0,30	0,35	0,41	0,46	0,51	0,56	0,61	0,67	0,72	0,80	0,87	1,01	1,16	1,30	1,45
200	0,40	0,50	0,60	0,70	0,80	0,90	1,00	1,11	1,21	1,31	1,41	1,56	1,70	2,09	2,26	2,53	2,83
300	0,60	0,75	0,90	1,04	1,19	1,34	1,48	1,63	1,78	1,92	2,07	2,28	2,48	2,88	3,31	3,71	4,13
400	0,80	1,00	1,19	1,37	1,56	1,75	1,94	2,13	2,31	2,50	2,69	2,88	3,13	3,64	4,18	4,68	5,22
500	1,00	1,25	1,48	1,70	1,93	2,16	2,38	2,6	2,84	3,06	3,29	3,51	3,83	4,47	5,11	5,75	6,39
600	1,20	1,50	1,75	2,00	2,25	2,50	2,75	3,01	3,26	3,51	3,76	4,11	4,49	5,23	5,98	6,73	7,48
700	1,40	1,75	2,03	2,31	2,59	2,87	3,15	3,44	3,72	4,00	4,28	4,68	5,08	5,88	6,67	7,47	8,27
800	1,60	2,00	2,31	2,62	2,93	3,23	3,54	3,85	4,16	4,47	4,78	5,21	5,64	6,50	7,35	8,21	9,07
900	1,80	2,25	2,58	2,92	3,25	3,58	3,92	4,25	4,58	4,92	5,25	5,71	6,17	7,09	8,02	8,94	9,86
1000	2,00	2,50	2,85	3,21	3,56	3,92	4,27	4,63	4,98	5,33	5,69	6,19	6,68	7,68	8,67	9,67	10,66
1100	2,23	2,71	3,09	3,46	3,84	4,22	4,59	4,97	5,35	5,72	6,10	6,63	7,17	8,24	9,31	10,38	11,45
1200	2,24	2,91	3,31	3,71	4,11	4,51	4,91	5,31	5,71	6,11	6,51	7,07	7,63	8,75	9,88	11,00	12,12
1300	2,65	3,12	3,54	3,96	4,39	4,81	5,23	5,65	6,07	6,50	6,92	7,51	8,09	9,27	10,44	11,62	12,79
1400	2,87	3,33	3,77	4,22	4,66	5,11	5,55	6,00	6,44	6,88	7,33	7,94	8,56	9,78	11,01	12,23	13,46
1500	3,05	3,52	4,00	4,46	4,93	5,40	5,87	6,34	6,80	7,27	7,74	8,38	9,02	10,30	11,57	12,85	14,13
1600	3,22	3,74	4,23	4,72	5,21	5,69	6,18	6,67	7,16	7,65	8,14	8,81	9,47	10,80	12,14	13,47	14,80
1700	3,36	3,95	4,46	4,97	5,48	5,99	6,50	7,02	7,53	8,04	8,55	9,24	9,94	11,32	12,71	14,09	15,48
1800	3,50	4,16	4,69	5,23	5,76	6,29	6,83	7,36	7,89	8,43	8,96	9,68	10,40	11,84	13,27	14,71	16,15
2000	3,85	4,57	5,15	5,73	6,31	6,88	7,46	8,04	8,62	9,20	9,78	10,55	11,32	12,86	14,40	15,95	17,49
2500	4,68	5,50	6,14	6,79	7,43	8,08	8,72	9,36	10,00	10,60	11,30	12,36	13,24	14,84	16,36	17,76	19,04
3000	5,35	6,43	7,11	7,80	8,48	9,16	9,85	10,53	11,22	11,90	13,50	14,17	15,16	16,83	18,33	19,57	20,59
3500	6,17	7,30	8,20	9,10	10,05	10,92	11,81	12,73	13,60	14,15	14,60	15,63	16,58	18,13	19,62	20,77	21,48
4000	7,08	8,22	9,16	10,09	11,03	11,97	12,90	13,85	14,78	15,30	15,80	16,78	17,80	19,62	20,90	21,58	21,58
4500	7,90	9,10	10,03	10,97	11,91	12,85	13,77	14,70	15,65	16,30	17,05	18,17	19,21	20,77	21,58	21,53	20,51
5000	8,72	9,90	10,92	11,94	12,96	13,99	15,01	16,00	17,05	17,68	18,35	19,41	20,33	21,48	21,58	20,51	18,10
6000	9,87	11,22	12,45	13,67	14,90	16,13	17,35	18,58	19,30	19,91	20,40	21,13	21,58	21,30	19,23	15,11	8,69

numero dei giri della puleggia minore / r.p.m. of smallest pulleys  
 Drehzahl der kleineren Reimenscheibe / nombre de tours de la petite poulie  
 número de revoluciones por minuto de la polea menor

Per trasmissioni che utilizzano cinghie di larghezza diversa da 25 mm, moltiplicare i valori di tabella per il fattore di larghezza cinghia.

For transmissions fitted with belts having a width different than 25 mm, multiply the values reported in the table by the belt width factor.

Für Übertragungen mit einer anderen Riemenbreite als 25 mm müssen die in der Tabelle aufgeführten Werte mit dem Faktor der Riemenbreite multipliziert werden.

Pour les transmissions qui utilisent des courroies d'une largeur autre que 25 mm, multiplier les valeurs du tableau par le facteur de largeur de la courroie.

Para transmisiones que usan correas de ancho que no sea 25 mm, multiplicar los valores de tabla por el factor de ancho correa.

### Fattori di larghezza della cinghia

### Belt width factor

### Faktor der Riemenbreite

### Facteurs de largeur de la courroie

### Factores de ancho correa

Larghezza cinghia / Belt width / Riemenbreite Largeur de la courroie / Ancho correa	10	15	20	25	30	42,5	50	65	85	100	118
Fattore moltiplicazione / Multiplication factor Multiplikationsfaktor / Facteur de multiplication Factor multiplicación	0,35	0,56	<b>0,77</b>	1,00	<b>1,21</b>	1,75	<b>2,08</b>	2,73	<b>3,60</b>	4,25	4,91

Le pulegge ed i numeri di giri corrispondenti a prestazioni comprese in quest'area possono venire impiegati solo se si accetta una riduzione di durata della cinghia.

The pulleys and RPMs corresponding to performance included in this area can be used only if a reduction in belt life is acceptable.

Die Riemenscheiben und die Anzahl der Umdrehungen, die den in diesem Bereich aufgeführten Leistungen entsprechen, können nur dann verwendet werden, wenn eine gewisse Minderung der Lebensdauer des Riemens in Kauf genommen wird.

Les poulies et les nombres de tours correspondant à des prestations comprises dans cette plage peuvent être utilisés uniquement si l'on accepte une réduction de durée de la courroie.

Las poleas y los números de revoluciones correspondientes a prestaciones comprendidas en esta área pueden ser empleadas sólo si se acepta una reducción de duración de la correa.

Per velocità superiori ai 30 m/sec., e cioè comprese in quest'area, è necessario impiegare pulegge speciali non essendo ammesso l'impiego di pulegge di serie.

For speeds of over 30 m/sec, that is, included in this area, the use of special pulleys is required; the use of standard pulleys is not possible.

Für die in diesem Bereich aufgeführten Laufgeschwindigkeiten über 30 m/s müssen Spezial-Riemenscheiben eingesetzt werden (ein Einsatz der Standard-Riemenscheiben ist nicht möglich).

Pour des vitesses supérieures à 30 m/sec. et donc comprise dans cette plage, il est nécessaire d'utiliser des poulies spéciales, l'utilisation de poulies de série n'étant pas admise.

Para velocidades superiores a 30 m/seg., esto es, comprendidas en esta área, es necesario emplear poleas especiales. En estos casos no está permitido el uso de poleas de serie.

Le pulegge comprese in quest'area sono soggette ad ambedue le limitazioni di cui sopra.

The pulleys included in this area are subjects to both of the restrictions listed above.

Die in diesem Bereich aufgeführten Riemenscheiben unterliegen beiden o.a. Einschränkungen.

Les poulies comprises dans cette plage sont soumises aux deux limitations mentionnées ci-dessus.

Las poleas comprendidas en esta área están sometidas a las dos limitaciones arriba indicadas.

# Prestazioni base cinghie HTD® 14M (Pb) / HTD® 14M (Pb) Basic belt performance Standardleistungen der Riemen HTD® 14M (Pb) Prestations de base des courroies HTD® 14M (Pb) / Prestaciones base correas HTD® 14M (Pb)

TABELLA 11/4 (Valori per 1" di larghezza) - kW	TABLE 11/4 (Values per 1" of width) - kW				TABELLE 11/4(Werte für 1" - Breite) - kW				TABLEAU 11/4 (Valeurs pour 1" de largeur) - kW				TABLA 11/4 (Valores para 1" de ancho) - kW			
N. denti / N. of teeth / Zähnezahl N.bre de dents / Cantidad de dientes	28	29	30	32	34	36	38	40	44	48	52	56	60	64	72	80
10	0,08	0,09	0,10	0,13	0,15	0,18	0,20	0,23	0,26	0,29	0,31	0,34	0,37	0,40	0,45	0,51
20	0,17	0,19	0,22	0,27	0,32	0,37	0,42	0,47	0,53	0,58	0,64	0,69	0,75	0,81	0,92	1,03
40	0,35	0,40	0,45	0,56	0,66	0,77	0,87	0,98	1,09	1,20	1,30	1,41	1,52	1,63	1,84	2,06
60	0,54	0,61	0,69	0,84	0,99	1,15	1,30	1,45	1,62	1,79	1,95	2,12	2,29	2,46	2,79	3,13
100	0,86	0,99	1,12	1,38	1,64	1,91	2,17	2,43	2,71	2,98	3,26	3,53	3,81	4,09	4,64	5,19
200	1,73	2,00	2,24	2,76	3,27	3,78	4,30	4,81	5,37	5,92	6,48	7,03	7,59	8,15	9,26	10,37
300	2,60	2,99	3,37	4,15	4,92	5,69	6,47	7,24	8,02	8,80	9,58	10,36	11,14	11,92	13,48	15,04
400	3,47	3,93	4,39	5,32	6,24	7,17	8,09	9,02	9,92	10,82	11,71	12,61	13,51	14,41	16,20	18,00
500	4,09	4,63	5,18	6,26	7,35	8,44	9,52	10,61	11,42	12,48	13,51	14,42	15,33	16,22	17,98	19,69
600	4,71	5,32	5,94	7,17	8,40	9,64	10,87	12,10	12,91	14,13	15,31	16,23	17,14	18,02	19,76	21,38
700	5,33	6,01	6,69	8,05	9,41	10,78	12,14	13,50	14,41	15,79	17,11	18,03	18,96	19,83	21,53	23,08
800	5,96	6,70	7,43	8,91	10,38	11,86	13,33	14,81	15,90	17,44	18,91	19,84	20,77	21,63	23,31	24,77
900	6,67	7,43	8,19	9,71	11,23	12,76	14,28	15,80	17,40	19,10	20,71	21,65	22,59	23,44	25,09	26,46
1000	7,48	8,25	9,03	10,59	12,14	13,69	15,25	16,80	18,44	20,13	21,77	22,73	23,64	24,51	26,06	27,38
1100	7,94	8,76	9,58	11,22	12,86	14,51	16,15	17,79	19,50	21,22	23,00	23,92	24,80	25,59	27,00	28,10
1200	8,40	9,26	10,13	11,86	13,59	15,32	17,05	18,78	20,55	22,32	24,14	25,05	25,96	26,78	28,14	29,23
1400	9,33	10,43	11,54	13,47	15,40	17,32	19,25	20,15	21,98	23,80	25,58	26,47	27,27	27,98	29,09	29,76
1600	10,25	11,46	12,73	14,64	16,55	18,47	20,38	21,40	23,24	25,08	26,79	27,58	28,24	28,81	29,56	29,69
1800	11,18	12,50	13,82	15,75	17,68	19,62	21,55	22,68	24,55	26,37	28,10	28,81	29,34	29,69	30,00	29,60
2000	12,20	13,64	14,80	16,78	18,77	20,75	22,74	23,86	25,70	27,43	28,96	29,40	29,66	29,60	28,92	27,40
2400	13,80	14,74	15,69	17,85	20,00	22,18	23,41	25,14	26,74	28,13	29,25	29,08	28,74	27,85	25,24	21,13
2800	15,58	16,51	17,54	19,36	21,18	23,00	24,83	25,54	26,69	27,53	28,00	27,02	25,54	23,67	18,34	11,01
3200	16,03	16,98	17,53	18,82	20,11	21,40	22,70	25,04	25,00	24,94	24,53	23,50	21,94	19,67	12,76	2,52
3600	16,30	17,60	18,23	19,66	21,08	22,51	23,94	24,54	24,56	24,06	22,35	19,97	16,66	12,60	1,15	-
4000	15,80	16,55	17,30	18,79	20,29	21,79	22,83	22,70	21,98	20,20	17,37	13,62	8,45	2,43	-	-

numero dei giri della puleggia minore / r.p.m. of smallest pulleys  
Drehzahl der kleineren Reimenscheibe / nombre de tours de la petite poulie  
numero de revoluciones por minuto de la polea menor

Per trasmissioni che utilizzano cinghie di larghezza diversa da 25 mm, moltiplicare i valori di tabella per il fattore di larghezza cinghia.

For transmissions fitted with belts having a width different than 25 mm, multiply the values reported in the table by the belt width factor.

Für Übertragungen mit einer anderen Riemenbreite als 25 mm müssen die in der Tabelle aufgeführten Werte mit dem Faktor der Riemenbreite multipliziert werden.

Pour les transmissions qui utilisent des courroies d'une largeur autre que 25 mm, multiplier les valeurs du tableau par le facteur de largeur de la courroie.

Para transmisiones que usan correas de ancho que no sea 25 mm, multiplicar los valores de tabla por el factor de ancho correa.

### Fattori di larghezza della cinghia

### Belt width factor

### Faktor der Riemenbreite

### Facteurs de largeur de la courroie

### Factores de ancho correa

Larghezza cinghia / Belt width / Riemenbreite Largeur de la courroie / Ancho correa	25	30	40	55	85	115	130	170	200	250
Fattore moltiplicazione / Multiplication factor Multiplikationsfaktor / Facteur de multiplication Factor multiplicación	1,00	1,17	1,51	2,14	3,55	5,07	5,81	7,82	9,30	11,30

Le pulegge ed i numeri di giri corrispondenti a prestazioni comprese in quest'area possono venire impiegati solo se si accetta una riduzione di durata della cinghia.

The pulleys and RPMs corresponding to performance included in this area can be used only if a reduction in belt life is acceptable.

Die Riemenscheiben und die Anzahl der Umdrehungen, die den in diesem Bereich aufgeführten Leistungen entsprechen, können nur dann verwendet werden, wenn eine gewisse Minderung der Lebensdauer des Riemens in Kauf genommen wird.

Les poulies et les nombres de tours correspondant à des prestations comprises dans cette plage peuvent être utilisés uniquement si l'on accepte une réduction de durée de la courroie.

Las poleas y los números de revoluciones correspondientes a prestaciones comprendidas en esta área pueden ser empleadas sólo si se acepta una reducción de duración de la correa.

Per velocità superiori ai 30 m/sec., e cioè comprese in quest'area, è necessario impiegare pulegge speciali non essendo ammesso l'impiego di pulegge di serie.

For speeds of over 30 m/sec, that is, included in this area, the use of special pulleys is required; the use of standard pulleys is not possible.

Für die in diesem Bereich aufgeführten Laufgeschwindigkeiten über 30 m/s müssen Spezial-Riemenscheiben eingesetzt werden (ein Einsatz der Standard-Riemenscheiben ist nicht möglich).

Pour des vitesses supérieures à 30 m/sec. et donc comprises dans cette plage, il est nécessaire d'utiliser des poulies spéciales, l'utilisation de poulies de série n'étant pas admise.

Para velocidades superiores a 30 m/seg., esto es, comprendidas en esta área, es necesario emplear poleas especiales. En estos casos no está permitido el uso de poleas de serie.

Le pulegge comprese in quest'area sono soggette ad ambedue le limitazioni di cui sopra.

The pulleys included in this area are subjects to both of the restrictions listed above.

Die in diesem Bereich aufgeführten Riemenscheiben unterliegen beiden o.a. Einschränkungen.

Les poulies comprises dans cette plage sont soumises aux deux limitations mentionnées ci-dessus.

Las poleas comprendidas en esta área están sometidas a las dos limitaciones arriba indicadas.

# Prestazioni base cinghie HTD® 20M (Pb) / HTD® 20M (Pb) Basic belt performance

## Standardleistungen der Riemen HTD® 20M (Pb)

## Prestations de base des courroies HTD® 20M (Pb) / Prestaciones base correas HTD® 20M (Pb)



TABELLA 11/5 (Valori per 1" di larghezza) - kW		TABLE 11/5 (Values per 1" of width) - kW			TABELLE 11/5 (Werte für 1" - Breite) - kW			TABLEAU 11/5 (Valeurs pour 1" de largeur) - kW			TABLA 11/5 (Valores para 1" de ancho) - kW			
N. denti / N. of teeth / Zähnezahl N.bre de dents / Cantidad de dientes	34	36	38	40	44	48	52	56	60	64	68	72	80	90
10	2,0	2,1	2,3	2,4	2,6	2,9	3,2	3,4	3,6	3,8	4,0	4,1	4,5	4,9
20	4,0	4,3	4,5	4,8	5,4	5,8	6,3	6,8	7,2	7,6	7,9	8,3	9,1	9,9
30	6,0	6,4	6,8	7,2	8,0	8,8	9,5	10,2	10,8	11,3	11,9	12,4	13,5	14,9
40	7,9	8,5	9,1	9,6	10,7	11,6	12,6	13,6	14,4	15,2	15,9	16,6	18,0	19,8
50	9,9	10,6	11,3	12,0	13,3	14,6	15,8	17,0	18,0	18,9	19,9	20,8	22,6	24,7
60	11,8	12,7	13,5	10,7	16,0	17,4	18,9	20,4	21,6	22,7	23,8	25,0	27,1	29,7
80	15,8	17,0	18,0	19,2	21,3	23,3	25,2	27,2	28,8	30,2	31,7	33,2	36,1	39,5
100	19,7	21,2	22,6	24,0	26,7	29,1	31,5	33,9	35,9	37,8	39,7	41,5	45,1	49,4
150	29,7	31,8	33,9	36,0	40,0	43,6	47,3	50,9	53,9	56,7	59,5	62,2	67,6	74,0
200	39,5	42,4	45,1	48,0	53,3	58,1	63,0	67,8	71,7	75,4	79,1	82,8	89,9	98,3
300	57,2	61,5	65,3	69,4	77,9	86,6	92,3	97,8	103,3	108,6	113,7	118,8	128,7	140,4
400	72,1	77,3	82,1	87,2	97,7	108,6	115,4	122,1	128,7	135,0	141,2	147,2	158,8	172,4
500	85,9	92,0	97,7	103,7	116,0	128,7	136,5	144,2	151,6	158,8	165,7	172,4	185,2	199,8
600	98,8	105,8	112,2	119,1	132,9	147,2	156,0	164,3	172,4	180,2	187,6	194,7	207,9	222,6
730	114,6	122,5	129,8	137,6	151,8	169,3	178,8	187,8	196,4	204,5	212,1	219,3	232,1	245,2
800	122,6	131,1	138,7	146,8	163,3	180,2	190,0	199,2	207,9	216,0	223,5	230,4	242,4	253,9
870	130,3	139,2	147,2	155,7	173,0	190,5	200,5	209,8	218,4	226,3	233,6	240,1	250,9	260,1
970	140,7	150,1	158,6	167,7	185,8	204,1	214,2	223,3	231,6	239,1	245,6	251,2	259,2	-
1170	159,7	170,0	179,1	188,9	208,0	227,4	236,8	244,9	251,7	257,1	261,1	263,5	263,9	-
1200	162,4	172,7	182,0	191,7	211,2	230,4	239,6	247,5	253,9	258,9	262,3	264,2	262,9	-
1460	183,0	193,9	203,4	213,4	232,8	251,6	258,0	262,4	264,4	263,9	260,9	-	-	-
1600	192,3	203,4	212,7	222,5	241,3	258,9	263,1	264,4	262,9	-	-	-	-	-
1750	200,9	211,8	220,8	230,1	247,7	263,4	264,2	261,8	-	-	-	-	-	-
2000	212,0	222,1	230,0	238,0	251,9	262,9	-	-	-	-	-	-	-	-

Per trasmissioni che utilizzano cinghie di larghezza diversa da 25 mm, moltiplicare i valori di tabella per il fattore di larghezza cinghia.

For transmissions fitted with belts having a width different than 25 mm, multiply the values reported in the table by the belt width factor.

Für Übertragungen mit einer anderen Riemenbreite als 25 mm müssen die in der Tabelle aufgeführten Werte mit dem Faktor der Riemenbreite multipliziert werden.

Pour les transmissions qui utilisent des courroies d'une largeur autre que 25 mm, multiplier les valeurs du tableau par le facteur de largeur de la courroie.

Para transmisiones que usan correas de ancho que no sea 25 mm, multiplicar los valores de tabla por el factor de ancho correa.

### Fattori di larghezza della cinghia

### Belt width factor

### Faktor der Riemenbreite

### Facteurs de largeur de la courroie

### Factores de ancho correa

Larghezza cinghia / Belt width / Riemenbreite Largeur de la courroie / Ancho correa	115	170	230 (≥ 38 denti)	290 (≥ 52 denti)	340 (≥ 52 denti)
Fattore moltiplicazione / Multiplication factor Multiplikationsfaktor / Facteur de multiplication Factor multiplicación	1,00	1,55	2,15	2,80	3,26

Le pulegge ed i numeri di giri corrispondenti a prestazioni comprese in quest'area possono venire impiegati solo se si accetta una riduzione di durata della cinghia.

The pulleys and RPMs corresponding to performance included in this area can be used only if a reduction in belt life is acceptable.

Die Riemenscheiben und die Anzahl der Umdrehungen, die den in diesem Bereich aufgeführten Leistungen entsprechen, können nur dann verwendet werden, wenn eine gewisse Minderung der Lebensdauer des Riemens in Kauf genommen wird.

Les poulies et les nombres de tours correspondant à des prestations comprises dans cette plage peuvent être utilisés uniquement si l'on accepte une réduction de durée de la courroie.

Las poleas y los números de revoluciones correspondientes a prestaciones comprendidas en esta área pueden ser empleadas sólo si se acepta una reducción de duración de la correa.

## Prestazioni base cinghie T 2,5 (Pb) / T 2,5 (Pb) Basic belt performance Standardleistungen der Riemen T 2,5 (Pb) Prestations de base des courroies T 2,5 (Pb) / Prestaciones base correas T 2,5 (Pb)

**TABELLA 12/1**  
(Valori per 10 mm di larghezza  
e ogni dente in presa) - kW<sup>3</sup>

**TABLE 12/1**  
(Calculated for 10 mm width  
with every tooth engaged) - kW<sup>3</sup>

**TABELLE 12/1**  
(Werte pro 10 mm - Breite und  
für jeden benutzten Zahn) - kW<sup>3</sup>

**TABLEAU 12/1**  
(Valeurs pour 10 mm de largeur  
et chaque dent en prise) - kW<sup>3</sup>

**TABLA 12/1**  
(Valores por 10 mm de ancho y  
cada diente en toma) - kW<sup>3</sup>

N. denti / N. of teeth / Zähnezahl N.bre de dents / Cantidad de dientes	10	11	12	14	15	16	18	20	22	24	28	30	32	34	36	38	40
100	-	-	-	-	-	-	-	-	-	-	-	-	-	-	-	-	-
200	1,20	1,45	1,60	1,90	2,20	2,45	2,60	2,95	3,20	3,40	3,75	4,00	4,30	4,65	4,95	5,30	5,65
300	1,45	1,70	1,85	2,18	2,40	2,60	3,00	3,35	3,70	3,95	4,25	4,45	4,70	5,00	5,35	5,65	6,05
400	1,70	1,95	2,15	2,35	2,60	2,80	3,40	3,65	3,85	4,15	4,50	4,85	5,15	5,50	5,85	6,30	6,90
500	1,85	2,03	2,23	2,53	2,75	2,95	3,45	3,80	4,13	4,45	4,75	5,05	5,40	5,85	6,30	6,95	7,30
600	2,00	2,10	2,30	2,70	2,90	3,20	3,50	4,10	4,40	4,80	5,60	6,00	6,40	6,80	7,20	7,60	8,00
725	2,30	2,50	2,70	3,10	3,40	3,65	4,10	4,75	5,10	5,55	6,50	7,00	7,45	7,90	8,35	8,80	9,25
800	2,50	2,80	3,00	3,60	3,90	4,20	4,70	5,40	5,80	6,30	7,40	8,00	8,50	9,00	9,50	10,00	10,50
900	2,70	3,00	3,25	3,90	4,20	4,50	5,10	5,80	6,25	6,80	7,90	8,50	9,05	9,60	10,25	10,85	11,50
1000	2,90	3,20	3,50	4,20	4,50	4,80	5,50	6,20	6,70	7,30	8,40	9,00	9,60	10,20	11,00	11,70	12,50
1100	3,20	3,50	3,90	4,60	4,95	5,30	6,05	6,90	7,40	8,05	9,40	10,00	10,70	11,40	12,20	12,95	13,75
1200	3,50	3,80	4,30	5,00	5,40	5,80	6,60	7,60	8,10	8,80	10,40	11,00	11,80	12,60	13,40	14,20	15,00
1300	3,90	4,15	4,65	5,45	5,90	6,25	7,15	8,25	8,80	9,60	11,30	12,00	12,80	13,65	14,50	15,40	16,25
1400	4,10	4,50	5,00	5,90	6,40	6,90	7,70	8,90	9,50	10,40	12,20	13,00	13,80	14,70	15,60	16,60	17,50
1425	4,18	4,58	5,08	6,00	6,50	7,00	7,84	9,05	9,66	10,58	12,43	13,25	14,08	15,00	15,90	16,90	17,81
1500	4,40	4,80	5,30	6,30	6,80	7,30	8,25	9,50	10,15	11,10	13,10	14,00	14,90	15,85	16,80	17,80	18,75
1600	4,70	5,10	5,60	6,70	7,20	7,70	8,80	10,10	10,80	11,80	14,00	15,00	16,00	17,00	18,00	19,00	20,00
1700	5,00	5,45	6,00	7,15	7,60	8,10	9,15	10,70	11,50	12,55	14,80	15,90	16,95	18,00	19,10	20,15	21,25
1800	5,30	5,80	6,40	7,60	8,00	8,50	9,50	11,30	12,20	13,30	15,60	16,80	17,90	19,00	20,20	21,30	22,50
1900	5,60	6,10	6,70	8,00	8,45	9,00	10,00	11,90	12,85	14,05	16,45	17,70	18,90	20,10	21,35	22,55	23,75
2000	5,90	6,40	7,00	8,40	8,90	9,50	10,50	12,50	13,50	14,80	17,30	18,60	19,90	21,20	22,50	23,80	25,00
2200	6,00	6,50	7,20	8,70	9,20	9,80	11,00	12,80	13,80	15,20	18,00	19,50	21,10	22,60	24,10	25,20	26,30
2400	6,30	7,00	7,70	9,30	9,90	10,70	12,00	13,50	14,30	15,80	18,90	20,50	21,90	23,40	24,80	26,30	27,50
2600	6,50	7,20	8,00	9,70	10,20	11,00	12,40	14,00	14,70	16,10	19,50	21,20	22,80	24,50	25,90	27,60	28,30
2800	6,90	7,60	8,40	10,10	10,60	11,40	12,80	14,60	15,60	17,10	20,20	21,80	23,30	24,70	26,30	28,10	29,00
2850	7,00	7,70	8,50	10,20	10,80	11,55	13,00	14,80	15,75	17,30	20,55	22,15	23,50	25,00	26,55	28,25	29,25
3000	7,20	7,90	8,80	10,60	11,40	12,10	13,70	15,50	16,30	18,00	21,20	23,30	24,60	26,00	27,40	28,70	30,00
3200	7,40	8,10	9,00	10,90	11,50	12,20	14,10	15,80	16,70	18,50	22,20	24,00	25,60	27,20	28,90	30,00	31,00
3400	7,70	8,40	9,30	11,10	11,80	12,70	14,50	16,30	17,30	19,10	22,70	24,60	26,10	27,60	29,10	30,50	32,00
3600	8,00	8,80	9,60	11,40	12,10	13,00	14,80	16,90	18,30	20,00	23,60	25,20	27,00	28,80	30,60	31,90	33,50
3800	8,40	9,20	10,10	12,10	12,80	13,70	15,50	18,10	19,30	21,10	24,80	26,60	28,40	30,20	32,00	33,80	35,50
4000	8,90	9,80	10,70	12,70	13,60	14,50	16,50	19,00	20,30	22,20	26,00	28,00	29,90	31,80	33,70	35,60	37,50
4200	9,30	10,30	11,30	13,30	14,30	15,30	17,30	20,10	21,40	23,40	27,40	29,40	31,40	33,40	35,40	37,40	39,40
4400	9,60	10,70	11,80	14,00	15,00	16,00	18,20	20,60	21,80	23,90	28,10	30,20	32,40	34,70	37,00	39,10	41,30
4600	9,90	10,90	12,00	14,20	15,20	16,20	18,40	21,00	22,20	24,20	28,40	30,50	32,70	35,00	37,30	39,50	41,70
4800	10,20	11,20	12,20	14,40	15,40	16,40	18,60	21,30	22,70	24,60	28,70	30,80	33,00	35,30	37,60	39,80	42,20
5000	10,50	11,50	12,50	14,50	15,50	16,60	18,80	21,80	23,20	25,20	29,20	31,10	33,50	35,80	38,20	40,40	42,80
5200	10,80	11,70	12,70	14,70	15,70	16,80	19,10	22,10	23,50	25,60	30,00	32,30	34,50	36,70	38,90	41,10	43,30
5400	11,10	12,00	12,90	14,80	15,90	17,10	19,40	22,50	23,90	26,00	30,40	32,70	35,30	37,90	40,50	43,00	45,50
5600	11,40	12,30	13,20	15,00	16,20	17,40	19,80	23,10	24,70	26,30	30,80	33,10	35,80	38,60	41,40	44,00	46,70
5800	11,70	12,60	13,50	15,20	16,40	17,70	20,10	23,50	25,10	26,70	31,20	33,50	36,50	39,40	42,40	45,40	48,40
6000	11,90	12,80	13,70	15,40	16,60	17,90	20,40	23,90	25,50	27,10	31,70	34,00	37,20	40,40	43,60	46,80	50,00
6500	12,20	13,10	14,00	16,00	17,30	18,80	21,75	25,30	26,70	27,90	32,75	35,35	38,65	42,25	45,45	48,85	52,25
7000	12,40	13,40	14,50	16,50	17,80	19,40	22,50	25,80	27,40	28,80	33,70	36,20	39,70	43,20	46,60	50,10	53,70
7500	12,50	13,50	14,60	16,70	18,00	19,70	22,90	26,20	27,80	29,20	34,10	36,80	40,30	43,90	47,50	51,00	54,50
8000	12,60	13,70	14,80	17,00	18,30	20,10	23,40	26,70	28,30	29,70	34,60	37,30	40,90	44,50	48,10	51,70	55,30
8500	12,80	14,10	15,40	18,00	19,40	20,90	23,80	27,20	28,90	30,50	35,60	38,30	41,80	45,40	48,90	52,50	56,00
9000	13,00	14,50	16,00	19,10	20,40	21,70	24,30	27,90	29,60	31,30	36,80	39,40	43,00	46,60	50,20	53,80	57,30
9500	13,20	14,70	16,30	19,40	20,70	22,10	24,80	28,60	30,30	32,10	37,70	40,40	43,90	47,50	51,10	54,60	58,00
10000	13,40	15,00	16,60	19,80	21,10	22,60	25,30	29,60	31,70	33,90	38,90	41,40	44,30	48,00	51,60	55,10	58,60
10500	13,50	15,15	16,80	20,00	21,35	22,85	25,55	29,90	32,05	34,30	39,20	41,90	45,05	48,60	52,10	55,45	58,85
11000	13,60	15,30	17,00	20,20	21,60	23,10	25,80	30,20	32,40	34,70	39,50	42,40	45,80	49,20	52,60	55,80	59,10
11500	13,75	15,40	17,05	20,35	21,75	23,30	26,05	30,50	32,75	35,10	40,10	42,95	46,20	49,65	52,95	56,15	59,45
12000	13,90	15,50	17,10	20,50	21,90	23,50	26,30	30,80	33,10	35,50	40,70	43,50	46,80	50,10	53,30	56,50	59,80
12500	14,05	15,65	17,25	20,60	22,00	23,65	26,50	31,05	33,45	35,80	41,30	44,00	47,00	50,55	53,75	56,95	60,25
13000	14,20	15,80	17,40	20,70	22,10	23,80	26,70	31,30	33,80	36,10	41,90	44,50	47,80	51,00	54,20	57,40	60,70
13500	14,35	15,95	17,55	20,80	22,20	23,95	26,85	31,55	34,25	36,30	42,20	45,00	48,30	51,50	54,70	57,90	61,15
14000	14,50	16,10	17,70	20,90	22,30	24,10	27,20	31,80	34,70	36,50	42,50	45,50	48,80	52,00	55,20	58,40	61,60
14500	14,65	16,25	17,85	21,05	22,55	24,25	27,40	32,05	34,90	36,80	42,90	46,05	49,20	52,55	55,70	58,85	62,05
15000	14,80	16,40	18,00	21,20	22,80	24,30	27,60	32,30	35,10	37,10	43,30	46,60	49,80	53,10	56,20	59,30	62,50

numero dei giri della puleggia minore / r.p.m. of smallest pulleys / Drehzahl der kleineren Reimenscheibe  
nombre de tours de la petite poulie / número de revoluciones por minuto de la polea menor

Le pulegge ed i numeri di giri corrispondenti a prestazioni comprese in quest'area possono venire impiegati solo se si accetta una riduzione di durata della cinghia.

The pulleys and RPMs corresponding to performance included in this area can be used only if a reduction in belt life is acceptable.

Die Riemenscheiben und die Anzahl der Umdrehungen, die den in diesem Bereich aufgeführten Leistungen entsprechen, können nur dann verwendet werden, wenn eine gewisse Minderung der Lebensdauer des Riemens in Kauf genommen wird.

Les poulies et les nombres de tours correspondant à des prestations comprises dans cette plage peuvent être utilisés uniquement si l'on accepte une réduction de durée de la courroie.

Las poleas y los números de revoluciones correspondientes a prestaciones comprendidas en esta área pueden ser empleadas sólo si se acepta una reducción de duración de la correa.

# Prestazioni base cinghie T 5 (Pb) / T 5 (Pb) Basic belt performance

## Standardleistungen der Riemen T 5 (Pb)

## Prestations de base des courroies T 5 (Pb) / Prestaciones base correas T 5 (Pb)



TABELLA 12/2

(Valori per 10 mm di larghezza e ogni dente in presa) - kW<sup>3</sup>

TABLE 12/2

(Calculated for 10 mm width with every tooth engaged) - kW<sup>3</sup>

TABELLE 12/2

(Werte pro 10 mm - Breite und für jeden benutzten Zahn) - kW<sup>3</sup>

TABLEAU 12/2

(Valeurs pour 10 mm de largeur et chaque dent en prise) - kW<sup>3</sup>

TABLA 12/2

(Valores por 10 mm de ancho y cada diente en toma) - kW<sup>3</sup>

N. denti / N. of teeth / Zähnezahl N.bre de dents / Cantidad de dientes	10	11	12	14	15	16	18	20	22	24	28	30	32	34	36	38	40
100	0,001	0,002	0,002	0,002	0,002	0,002	0,003	0,003	0,003	0,004	0,004	0,005	0,005	0,005	0,005	0,006	0,006
200	0,003	0,003	0,003	0,004	0,004	0,005	0,005	0,006	0,007	0,007	0,008	0,009	0,010	0,010	0,011	0,011	0,012
300	0,004	0,005	0,005	0,006	0,006	0,007	0,008	0,009	0,009	0,010	0,012	0,013	0,014	0,015	0,016	0,017	0,017
400	0,005	0,006	0,007	0,008	0,008	0,009	0,010	0,011	0,012	0,014	0,016	0,017	0,018	0,019	0,021	0,022	0,023
500	0,007	0,007	0,008	0,010	0,010	0,011	0,012	0,014	0,015	0,017	0,020	0,021	0,022	0,024	0,025	0,027	0,028
600	0,008	0,009	0,010	0,011	0,012	0,013	0,015	0,016	0,018	0,020	0,023	0,025	0,026	0,028	0,030	0,031	0,033
700	0,009	0,010	0,011	0,013	0,014	0,015	0,017	0,019	0,021	0,023	0,026	0,028	0,030	0,032	0,034	0,036	0,038
800	0,010	0,011	0,012	0,015	0,016	0,017	0,019	0,021	0,023	0,025	0,028	0,030	0,032	0,034	0,036	0,038	0,041
900	0,011	0,013	0,014	0,016	0,017	0,019	0,021	0,023	0,026	0,028	0,033	0,035	0,038	0,040	0,043	0,045	0,047
1000	0,012	0,014	0,015	0,018	0,019	0,020	0,023	0,026	0,028	0,031	0,036	0,039	0,041	0,044	0,047	0,049	0,052
1100	0,013	0,015	0,016	0,019	0,021	0,022	0,025	0,028	0,031	0,033	0,039	0,042	0,045	0,048	0,050	0,053	0,056
1200	0,015	0,016	0,018	0,021	0,022	0,024	0,027	0,030	0,033	0,036	0,042	0,045	0,048	0,052	0,055	0,058	0,061
1300	0,016	0,017	0,019	0,022	0,024	0,026	0,029	0,032	0,036	0,039	0,046	0,049	0,052	0,055	0,059	0,062	0,065
1400	0,017	0,019	0,020	0,024	0,026	0,027	0,031	0,034	0,038	0,042	0,049	0,052	0,056	0,059	0,063	0,066	0,070
1425	0,017	0,019	0,020	0,024	0,026	0,027	0,031	0,034	0,038	0,042	0,049	0,052	0,056	0,059	0,063	0,066	0,070
1500	0,018	0,020	0,022	0,025	0,027	0,029	0,033	0,037	0,040	0,044	0,052	0,055	0,059	0,063	0,067	0,070	0,074
1600	0,019	0,021	0,023	0,027	0,029	0,030	0,034	0,039	0,042	0,046	0,054	0,058	0,062	0,066	0,070	0,074	0,078
1700	0,020	0,022	0,024	0,028	0,030	0,032	0,036	0,041	0,045	0,049	0,057	0,061	0,066	0,070	0,074	0,078	0,082
1800	0,021	0,023	0,025	0,029	0,031	0,034	0,038	0,042	0,047	0,051	0,060	0,064	0,068	0,073	0,077	0,081	0,086
1900	0,021	0,024	0,026	0,031	0,033	0,035	0,040	0,044	0,049	0,053	0,062	0,067	0,071	0,076	0,081	0,085	0,090
2000	0,022	0,025	0,027	0,032	0,034	0,037	0,041	0,046	0,051	0,056	0,065	0,070	0,075	0,079	0,084	0,089	0,094
2200	0,024	0,027	0,030	0,035	0,037	0,040	0,045	0,050	0,056	0,061	0,071	0,076	0,081	0,087	0,092	0,097	0,102
2400	0,026	0,029	0,032	0,037	0,040	0,043	0,048	0,054	0,060	0,065	0,076	0,082	0,087	0,093	0,098	0,104	0,110
2600	0,028	0,031	0,034	0,040	0,043	0,046	0,052	0,058	0,064	0,069	0,081	0,087	0,093	0,099	0,105	0,111	0,117
2800	0,030	0,033	0,036	0,042	0,045	0,048	0,055	0,061	0,067	0,073	0,086	0,092	0,098	0,105	0,111	0,117	0,123
2850	0,030	0,033	0,036	0,042	0,045	0,048	0,055	0,061	0,067	0,073	0,086	0,092	0,098	0,105	0,111	0,117	0,123
3000	0,031	0,034	0,038	0,044	0,048	0,051	0,057	0,064	0,071	0,077	0,090	0,097	0,104	0,110	0,117	0,123	0,130
3200	0,033	0,036	0,040	0,046	0,050	0,053	0,060	0,067	0,074	0,081	0,095	0,102	0,109	0,115	0,122	0,129	0,136
3400	0,034	0,038	0,041	0,048	0,052	0,056	0,063	0,070	0,077	0,085	0,099	0,106	0,113	0,120	0,128	0,135	0,142
3600	0,035	0,039	0,043	0,050	0,054	0,058	0,065	0,073	0,080	0,088	0,103	0,110	0,118	0,125	0,133	0,140	0,148
3800	0,037	0,041	0,045	0,053	0,057	0,060	0,068	0,076	0,084	0,092	0,107	0,115	0,123	0,131	0,139	0,146	0,154
4000	0,039	0,043	0,047	0,055	0,059	0,063	0,071	0,079	0,088	0,096	0,112	0,120	0,128	0,136	0,145	0,153	0,161
4200	0,040	0,044	0,048	0,057	0,061	0,065	0,073	0,082	0,090	0,099	0,115	0,124	0,132	0,140	0,149	0,157	0,166
4400	0,041	0,045	0,049	0,058	0,062	0,067	0,075	0,084	0,093	0,101	0,118	0,127	0,136	0,144	0,153	0,162	0,170
4600	0,042	0,046	0,051	0,060	0,064	0,068	0,077	0,086	0,095	0,104	0,121	0,130	0,139	0,148	0,157	0,165	0,174
4800	0,043	0,048	0,052	0,061	0,066	0,070	0,080	0,089	0,098	0,107	0,125	0,135	0,144	0,153	0,162	0,171	0,180
5000	0,044	0,049	0,054	0,063	0,068	0,073	0,082	0,092	0,101	0,110	0,129	0,139	0,148	0,157	0,167	0,176	0,186
5200	0,046	0,051	0,055	0,065	0,070	0,075	0,085	0,094	0,104	0,114	0,133	0,143	0,152	0,162	0,172	0,181	0,191
5400	0,047	0,052	0,057	0,067	0,072	0,077	0,087	0,097	0,107	0,117	0,137	0,147	0,156	0,166	0,176	0,186	0,196
5600	0,049	0,054	0,059	0,069	0,075	0,080	0,090	0,100	0,111	0,121	0,142	0,152	0,162	0,172	0,183	0,193	0,204
5800	0,050	0,055	0,061	0,071	0,077	0,082	0,092	0,103	0,114	0,124	0,145	0,156	0,166	0,177	0,187	0,198	0,209
6000	0,051	0,057	0,062	0,073	0,078	0,084	0,094	0,105	0,116	0,127	0,149	0,159	0,170	0,181	0,192	0,203	0,213
6500	0,054	0,060	0,066	0,078	0,083	0,089	0,100	0,112	0,124	0,135	0,158	0,170	0,181	0,192	0,204	0,216	0,227
7000	0,057	0,063	0,069	0,081	0,087	0,093	0,105	0,118	0,130	0,142	0,166	0,178	0,190	0,202	0,214	0,226	0,238
7500	0,060	0,066	0,072	0,085	0,091	0,098	0,110	0,123	0,136	0,148	0,174	0,186	0,199	0,211	0,224	0,237	0,249
8000	0,063	0,070	0,076	0,090	0,096	0,103	0,116	0,130	0,143	0,157	0,183	0,196	0,210	0,223	0,236	0,250	0,263
8500	0,065	0,072	0,079	0,093	0,100	0,107	0,121	0,135	0,149	0,162	0,190	0,204	0,218	0,231	0,245	0,259	0,273
9000	0,068	0,076	0,083	0,097	0,105	0,112	0,126	0,141	0,156	0,170	0,199	0,213	0,228	0,242	0,256	0,271	0,285
9500	0,071	0,079	0,086	0,102	0,109	0,116	0,132	0,147	0,162	0,177	0,207	0,222	0,237	0,252	0,267	0,282	0,298
10000	0,074	0,082	0,090	0,106	0,113	0,121	0,137	0,153	0,169	0,184	0,215	0,231	0,247	0,262	0,278	0,294	0,309
10500	0,076	0,085	0,093	0,109	0,118	0,125	0,142	0,158	0,175	0,190	0,222	0,239	0,256	0,272	0,288	0,305	0,315
11000	0,079	0,088	0,096	0,113	0,122	0,130	0,147	0,164	0,181	0,197	0,231	0,248	0,265	0,281	0,298	0,315	0,332
11500	0,081	0,090	0,098	0,116	0,125	0,133	0,150	0,168	0,185	0,202	0,236	0,254	0,271	0,288	0,305	0,322	0,340
12000	0,083	0,092	0,101	0,119	0,128	0,136	0,154	0,172	0,190	0,207	0,242	0,260	0,277	0,295	0,313	0,330	0,348
12500	0,085	0,094	0,103	0,122	0,130	0,139	0,157	0,175	0,194	0,211	0,247	0,265	0,283	0,301	0,319	0,337	0,355
13000	0,087	0,096	0,105	0,124	0,133	0,142	0,160	0,179	0,197	0,215	0,252	0,270	0,289	0,307	0,325	0,344	0,362
13500	0,089	0,098	0,107	0,126	0,136	0,145	0,164	0,183	0,202	0,220	0,258	0,276	0,296	0,314	0,333	0,352	0,370
14000	0,091	0,100	0,110	0,129	0,139	0,148	0,168	0,187	0,207	0,226	0,264	0,283	0,302	0,321	0,340	0,360	0,379
14500	0,092	0,102	0,113	0,132	0,142	0,151	0,171	0,191	0,211	0,230	0,269	0,289	0,308	0,328	0,347	0,367	0,387
15000	0,094	0,105	0,115	0,135	0,145	0,154	0,174	0,195	0,215	0,235	0,275	0,295	0,314	0,334	0,354	0,374	0,395

numero dei giri della puleggia minore / r.p.m. of smallest pulleys / Drehzahl der kleineren Reimentscheibe  
nombre de tours de la petite poulie / número de revoluciones por minuto de la polea menor

Le pulegge ed i numeri di giri corrispondenti a prestazioni comprese in quest'area possono venire impiegati solo se si accetta una riduzione di durata della cinghia.

The pulleys and RPMs corresponding to performance included in this area can be used only if a reduction in belt life is acceptable.

Die Riemenscheiben und die Anzahl der Umdrehungen, die den in diesem Bereich aufgeführten Leistungen entsprechen, können nur dann verwendet werden, wenn eine gewisse Minderung der Lebensdauer des Riemens in Kauf genommen wird.

Les poulies et les nombres de tours correspondant à des prestations comprises dans cette plage peuvent être utilisés uniquement si l'on accepte une réduction de durée de la courroie.</

**TABELLA 12/3**  
(Valori per 10 mm di larghezza  
e ogni dente in presa) - kW<sup>3</sup>

**TABLE 12/3**  
(Calculated for 10 mm width  
with every tooth engaged) - kW<sup>3</sup>

**TABELLE 12/3**  
(Werte pro 10 mm - Breite und  
für jeden benutzten Zahn) - kW<sup>3</sup>

**TABLEAU 12/3**  
(Valeurs pour 10 mm de largeur  
et chaque dent en prise) - kW<sup>3</sup>

**TABLA 12/3**  
(Valores por 10 mm de ancho y  
cada diente en toma) - kW<sup>3</sup>

N. denti / N. of teeth / Zähnezahl N.bre de dents / Cantidad de dientes	12	14	16	18	20	22	24	26	28	30	32	36	40	48
100	0,007	0,008	0,010	0,011	0,012	0,014	0,014	0,016	0,017	0,019	0,020	0,022	0,025	0,030
200	0,014	0,016	0,019	0,021	0,024	0,026	0,028	0,031	0,034	0,036	0,038	0,043	0,048	0,058
300	0,020	0,024	0,027	0,031	0,034	0,038	0,041	0,045	0,049	0,052	0,056	0,063	0,070	0,084
400	0,026	0,031	0,035	0,040	0,044	0,049	0,053	0,058	0,063	0,067	0,072	0,081	0,090	0,108
500	0,032	0,037	0,043	0,049	0,054	0,060	0,065	0,071	0,077	0,082	0,088	0,099	0,110	0,133
600	0,037	0,044	0,051	0,057	0,064	0,070	0,076	0,083	0,090	0,097	0,103	0,116	0,129	0,156
700	0,042	0,050	0,057	0,065	0,072	0,080	0,087	0,094	0,102	0,109	0,117	0,132	0,146	0,176
800	0,048	0,056	0,064	0,073	0,081	0,089	0,097	0,106	0,115	0,123	0,131	0,148	0,165	0,198
900	0,052	0,062	0,071	0,080	0,089	0,098	0,105	0,117	0,126	0,135	0,144	0,163	0,181	0,218
1000	0,057	0,067	0,077	0,087	0,097	0,107	0,116	0,127	0,136	0,146	0,156	0,176	0,196	0,236
1100	0,062	0,073	0,084	0,095	0,105	0,116	0,127	0,138	0,149	0,160	0,171	0,192	0,214	0,258
1200	0,067	0,079	0,091	0,102	0,114	0,126	0,137	0,149	0,161	0,173	0,185	0,208	0,232	0,279
1300	0,071	0,084	0,096	0,109	0,122	0,134	0,146	0,159	0,172	0,184	0,197	0,222	0,247	0,297
1400	0,076	0,089	0,102	0,115	0,129	0,142	0,155	0,168	0,182	0,195	0,208	0,235	0,261	0,314
1425	0,078	0,091	0,105	0,118	0,132	0,145	0,157	0,170	0,185	0,198	0,212	0,238	0,265	0,318
1500	0,080	0,094	0,108	0,122	0,135	0,149	0,163	0,177	0,191	0,205	0,219	0,247	0,275	0,331
1600	0,084	0,098	0,113	0,127	0,142	0,157	0,171	0,186	0,200	0,215	0,230	0,259	0,288	0,347
1700	0,087	0,102	0,118	0,133	0,148	0,163	0,178	0,194	0,209	0,225	0,240	0,270	0,301	0,362
1800	0,091	0,107	0,123	0,139	0,155	0,171	0,187	0,203	0,219	0,236	0,252	0,284	0,316	0,380
1900	0,095	0,111	0,128	0,145	0,161	0,178	0,194	0,211	0,227	0,244	0,261	0,294	0,327	0,393
2000	0,099	0,116	0,133	0,151	0,168	0,185	0,202	0,220	0,237	0,255	0,272	0,306	0,341	0,410
2200	0,107	0,125	0,144	0,163	0,181	0,200	0,218	0,237	0,256	0,275	0,293	0,331	0,368	0,443
2400	0,113	0,133	0,152	0,172	0,192	0,212	0,231	0,251	0,271	0,291	0,311	0,350	0,390	0,469
2600	0,120	0,141	0,162	0,183	0,204	0,225	0,246	0,267	0,288	0,309	0,330	0,372	0,414	0,498
2800	0,127	0,149	0,171	0,193	0,215	0,237	0,259	0,282	0,304	0,326	0,348	0,393	0,437	0,526
2850	0,129	0,152	0,173	0,195	0,218	0,240	0,262	0,285	0,307	0,330	0,351	0,395	0,430	0,530
3000	0,133	0,156	0,179	0,203	0,226	0,249	0,272	0,296	0,319	0,342	0,365	0,412	0,458	0,552
3200	0,139	0,163	0,187	0,212	0,236	0,260	0,284	0,309	0,333	0,357	0,382	0,430	0,479	0,576
3400	0,146	0,171	0,197	0,222	0,248	0,273	0,299	0,324	0,350	0,376	0,401	0,452	0,503	0,605
3600	0,151	0,177	0,204	0,230	0,257	0,283	0,309	0,336	0,362	0,389	0,415	0,468	0,521	0,627
3800	0,156	0,183	0,210	0,238	0,265	0,292	0,319	0,347	0,374	0,401	0,429	0,483	0,538	0,647
4000	0,160	0,188	0,216	0,245	0,273	0,301	0,328	0,357	0,385	0,413	0,441	0,497	0,553	0,666
4200	0,166	0,195	0,224	0,254	0,283	0,312	0,341	0,370	0,399	0,429	0,458	0,516	0,574	0,691
4400	0,170	0,200	0,230	0,260	0,289	0,319	0,349	0,379	0,409	0,438	0,468	0,528	0,587	0,707
4600	0,176	0,206	0,237	0,268	0,299	0,330	0,360	0,391	0,422	0,453	0,484	0,545	0,607	0,730
4800	0,181	0,213	0,244	0,276	0,308	0,340	0,371	0,403	0,435	0,467	0,498	0,562	0,625	0,752
5000	0,186	0,219	0,252	0,284	0,317	0,349	0,382	0,415	0,447	0,480	0,513	0,578	0,643	0,774
5200	0,191	0,225	0,258	0,292	0,325	0,359	0,392	0,426	0,460	0,493	0,527	0,594	0,661	0,795
5400	0,196	0,231	0,265	0,299	0,334	0,368	0,402	0,437	0,471	0,506	0,540	0,609	0,677	0,815
5600	0,201	0,236	0,271	0,307	0,342	0,377	0,412	0,447	0,482	0,518	0,553	0,623	0,694	0,834
5800	0,205	0,241	0,277	0,313	0,349	0,385	0,421	0,457	0,493	0,529	0,565	0,637	0,709	0,853
6000	0,210	0,246	0,283	0,320	0,357	0,393	0,430	0,467	0,503	0,540	0,577	0,650	0,724	0,871
6500	0,217	0,255	0,293	0,331	0,370	0,408	0,445	0,484	0,521	0,580	0,598	0,674	0,750	0,903
7000	0,225	0,264	0,304	0,343	0,383	0,422	0,461	0,501	0,540	0,580	0,619	0,698	0,777	0,935
7500	0,234	0,275	0,316	0,357	0,398	0,439	0,480	0,521	0,562	0,603	0,644	0,726	0,808	-
8000	0,242	0,285	0,327	0,370	0,412	0,454	0,497	0,539	0,582	0,624	0,667	0,752	0,836	-
8500	0,250	0,293	0,337	0,381	0,424	0,468	0,511	0,555	0,599	0,643	0,687	0,774	0,861	-
9000	0,256	0,301	0,345	0,390	0,435	0,480	0,524	0,569	0,614	0,659	0,704	0,794	0,883	-
9500	0,261	0,307	0,352	0,398	0,444	0,490	0,535	0,581	0,627	0,673	0,719	0,810	-	-
10000	0,270	0,318	0,365	0,412	0,460	0,507	0,554	0,602	0,649	0,696	0,744	0,838	-	-
10500	0,278	0,327	0,376	0,425	0,474	0,522	0,571	0,620	0,669	0,718	0,767	-	-	-
11000	0,287	0,337	0,387	0,438	0,488	0,538	0,588	0,639	0,689	0,740	0,790	-	-	-
11500	0,294	0,346	0,397	0,449	0,500	0,552	0,603	0,655	0,707	0,759	-	-	-	-
12000	0,302	0,355	0,407	0,461	0,513	0,566	0,619	0,672	0,726	0,778	-	-	-	-
12500	0,308	0,362	0,416	0,471	0,519	0,578	0,632	0,686	-	-	-	-	-	-
13000	0,315	0,370	0,426	0,481	0,536	0,591	0,646	0,701	-	-	-	-	-	-
13500	0,320	0,376	0,432	0,489	0,545	0,601	0,657	-	-	-	-	-	-	-
14000	0,326	0,383	0,440	0,498	0,555	0,612	0,669	-	-	-	-	-	-	-
14500	0,327	0,384	0,441	0,499	0,557	0,614	-	-	-	-	-	-	-	-
15000	0,329	0,386	0,443	0,501	0,559	0,616	-	-	-	-	-	-	-	-

numero dei giri della puleggia minore / r.p.m. of smallest pulleys / Drehzahl der kleineren Reimenscheibe  
nombre de tours de la petite poulie / número de revoluciones por minuto de la polea menor

Le pulegge ed i numeri di giri corrispondenti a prestazioni comprese in quest'area possono venire impiegati solo se si accetta una riduzione di durata della cinghia.

The pulleys and RPMs corresponding to performance included in this area can be used only if a reduction in belt life is acceptable.

Die Riemenscheiben und die Anzahl der Umdrehungen, die den in diesem Bereich aufgeführten Leistungen entsprechen, können nur dann verwendet werden, wenn eine gewisse Minderung der Lebensdauer des Riemens in Kauf genommen wird.

Les poulies et les nombres de tours correspondant à des prestations comprises dans cette plage peuvent être utilisés uniquement si l'on accepte une réduction de durée de la courroie.

Las poleas y los números de revoluciones correspondientes a prestaciones comprendidas en esta área pueden ser empleadas sólo si se acepta una reducción de duración de la correa.

Per velocità superiori ai 30 m/sec., e cioè comprese in quest'area, è necessario impiegare pulegge speciali non essendo ammesso l'impiego di pulegge di serie.

For speeds of over 30 m/sec, that is, included in this area, the use of special pulleys is required; the use of standard pulleys is not possible.

Für die in diesem Bereich aufgeführten Laufgeschwindigkeiten über 30 m/s müssen Spezial-Riemenscheiben eingesetzt werden (ein Einsatz der Standard-Riemenscheiben ist nicht möglich).

Pour des vitesses supérieures à 30 m/sec. et donc comprises dans cette plage, il est nécessaire d'utiliser des poulies spéciales, l'utilisation de poulies de série n'étant pas admise.

Para velocidades superiores a 30 m/seg., esto es, comprendidas en esta área, es necesario emplear poleas especiales. En estos casos no está permitido el uso de poleas de serie.

Le pulegge comprese in quest'area sono soggette ad ambedue le limitazioni di cui sopra.

The pulleys included in this area are subjects to both of the restrictions listed above.

Die in diesem Bereich aufgeführten Riemenscheiben unterliegen beiden o.a. Einschränkungen.

Les poulies comprises dans cette plage sont soumises aux deux limitations mentionnées ci-dessus.

Las poleas comprendidas en esta área están sometidas a las dos limitaciones arriba indicadas.



# Prestazioni base cinghie T 20 (Pb) / T 20 (Pb) Basic belt performance

## Standardleistungen der Riemen T 20 (Pb)

## Prestations de base des courroies T 20 (Pb) / Prestaciones base correas T 20 (Pb)



**TABELLA 12/4**  
(Valori per 10 mm di larghezza e ogni dente in presa) - kW<sup>3</sup>

**TABLE 12/4**  
(Calculated for 10 mm width with every tooth engaged) - kW<sup>3</sup>

**TABELLE 12/4**  
(Werte pro 10 mm - Breite und für jeden benutzten Zahn) - kW<sup>3</sup>

**TABLEAU 12/4**  
(Valeurs pour 10 mm de largeur et chaque dent en prise) - kW<sup>3</sup>

**TABLA 12/4**  
(Valores por 10 mm de ancho y cada diente en toma) - kW<sup>3</sup>

N. denti / N. of teeth / Zähnezahl N.bre de dents / Cantidad de dientes	15	16	18	20	22	24	25	26	28	30	32	34	36	40	44	48	60
100	0,036	0,039	0,044	0,049	0,053	0,058	0,061	0,063	0,068	0,073	0,078	0,083	0,088	0,098	0,108	0,118	0,148
200	0,067	0,072	0,081	0,091	0,100	0,109	0,114	0,118	0,128	0,137	0,146	0,156	0,165	0,183	0,202	0,220	0,276
300	0,096	0,103	0,116	0,129	0,142	0,156	0,162	0,169	0,182	0,195	0,209	0,222	0,235	0,261	0,288	0,314	0,394
400	0,122	0,130	0,147	0,163	0,180	0,197	0,205	0,214	0,230	0,247	0,264	0,280	0,297	0,331	0,364	0,397	0,498
500	0,146	0,156	0,176	0,196	0,216	0,236	0,246	0,256	0,277	0,297	0,317	0,337	0,357	0,397	0,437	0,477	0,598
600	0,171	0,183	0,206	0,230	0,256	0,277	0,289	0,300	0,324	0,347	0,371	0,394	0,418	0,465	0,512	0,559	0,700
700	0,191	0,204	0,231	0,257	0,283	0,310	0,323	0,336	0,362	0,388	0,415	0,441	0,467	0,520	0,572	0,625	0,783
800	0,209	0,223	0,252	0,281	0,310	0,338	0,353	0,367	0,396	0,425	0,453	0,482	0,511	0,568	0,626	0,683	0,855
900	0,224	0,240	0,271	0,302	0,332	0,363	0,379	0,394	0,425	0,456	0,487	0,518	0,548	0,610	0,672	0,733	0,919
1000	0,238	0,254	0,287	0,319	0,352	0,384	0,401	0,417	0,450	0,482	0,515	0,548	0,580	0,646	0,711	0,776	0,972
1100	0,259	0,276	0,312	0,348	0,383	0,419	0,436	0,454	0,490	0,525	0,561	0,596	0,632	0,703	0,774	0,845	1,059
1200	0,277	0,295	0,334	0,372	0,409	0,448	0,466	0,485	0,524	0,562	0,599	0,638	0,676	0,752	0,827	0,903	1,131
1300	0,296	0,317	0,358	0,398	0,439	0,480	0,500	0,520	0,561	0,602	0,643	0,684	0,724	0,806	0,887	0,969	1,213
1400	0,313	0,334	0,377	0,420	0,463	0,506	0,527	0,549	0,592	0,635	0,678	0,721	0,764	0,850	0,936	1,021	1,279
1425	0,314	0,336	0,380	0,425	0,468	0,512	0,533	0,583	0,597	0,642	0,686	0,729	0,773	0,860	0,947	1,133	1,294
1500	0,328	0,350	0,395	0,441	0,485	0,531	0,553	0,576	0,621	0,666	0,711	0,756	0,801	0,891	0,981	1,071	1,341
1600	0,342	0,366	0,413	0,460	0,507	0,554	0,577	0,601	0,648	0,695	0,742	0,789	0,836	0,930	1,024	1,118	1,400
1700	0,359	0,384	0,434	0,483	0,532	0,582	0,606	0,631	0,680	0,730	0,779	0,829	0,878	0,977	1,076	1,174	1,471
1800	0,376	0,402	0,454	0,506	0,557	0,609	0,635	0,661	0,712	0,764	0,816	0,868	0,919	1,023	1,126	1,229	1,540
1900	0,388	0,415	0,468	0,522	0,575	0,628	0,655	0,681	0,735	0,788	0,842	0,895	0,948	1,055	1,162	1,268	1,588
2000	0,404	0,432	0,487	0,543	0,598	0,654	0,681	0,709	0,765	0,820	0,876	0,931	0,987	1,098	1,209	1,319	1,652
2200	0,434	0,464	0,523	0,583	0,642	0,702	0,732	0,762	0,821	0,881	0,940	1,000	1,060	1,179	1,298	1,417	
2400	0,462	0,493	0,557	0,621	0,684	0,747	0,779	0,811	0,874	0,938	1,001	1,065	1,128	1,255	1,382	1,509	
2600	0,488	0,521	0,589	0,656	0,723	0,790	0,823	0,857	0,924	0,991	1,058	1,125	1,192	1,326	1,460	1,594	
2800	0,506	0,540	0,610	0,679	0,749	0,818	0,853	0,887	0,957	1,037	1,096	1,165	1,235	1,374	1,513		
2850	0,511	0,543	0,616	0,683	0,757	0,827	0,862	0,896	0,967	1,045	1,107	1,177	1,248	1,390	1,529		
3000	0,527	0,564	0,636	0,709	0,781	0,854	0,890	0,926	0,998	1,071	1,143	1,216	1,288	1,433	1,578		
3200	0,547	0,585	0,660	0,736	0,811	0,886	0,923	0,961	1,036	1,112	1,187	1,262	1,337	1,488			
3400	0,565	0,604	0,682	0,760	0,837	0,915	0,954	0,993	1,070	1,148	1,226	1,304	1,381	1,537			
3600	0,582	0,621	0,701	0,781	0,861	0,941	0,981	1,021	1,101	1,181	1,261	1,341	1,421				
3800	0,596	0,637	0,719	0,801	0,882	0,964	1,005	1,048	1,128	1,210	1,292	1,374	1,456				
4000	0,608	0,650	0,734	0,817	0,901	0,984	1,026	1,068	1,151	1,235	1,318	1,402					
4200	0,619	0,661	0,746	0,831	0,918	1,001	1,044	1,086	1,171	1,256	1,341						
4400	0,638	0,681	0,769	0,857	0,944	1,032	1,076	1,119	1,207	1,295							
4600	0,656	0,701	0,791	0,881	0,971	1,061	1,106	1,151	1,241								
4800	0,673	0,719	0,811	0,904	0,996	1,089	1,135	1,181									
5000	0,689	0,736	0,831	0,926	1,020	1,115	1,162										
5200	0,692	0,739	0,834	0,930	1,024												
5400	0,705	0,753	0,850	0,947													
5600	0,706	0,754	0,851														
5800	0,716	0,766															
6000	0,741																

numero dei giri della puleggia minore / r.p.m. of smallest pulleys / Drehzahl der kleineren Reimenscheibe  
nombre de tours de la petite poulie / número de revoluciones por minuto de la polea menor

The pulleys and RPMs corresponding to performance included in this area can be used only if a reduction in belt life is acceptable.

Die Riemenscheiben und die Anzahl der Umdrehungen, die den in diesem Bereich aufgeführten Leistungen entsprechen, können nur dann verwendet werden, wenn eine gewisse Minderung der Lebensdauer des Riemens in Kauf genommen wird.

Les poulies et les nombres de tours correspondant à des prestations comprises dans cette plage peuvent être utilisés uniquement si l'on accepte une réduction de durée de la courroie.

Las poleas y los números de revoluciones correspondientes a prestaciones comprendidas en esta área pueden ser empleadas sólo si se acepta una reducción de duración de la correa.

For speeds of over 30 m/sec, that is, included in this area, the use of special pulleys is required; the use of standard pulleys is not possible.

Für die in diesem Bereich aufgeführten Laufgeschwindigkeiten über 30 m/s müssen Spezial-Riemenscheiben eingesetzt werden (ein Einsatz der Standard- Riemenscheiben ist nicht möglich).

Pour des vitesses supérieures à 30 m/sec. et donc comprise dans cette plage, il est nécessaire d'utiliser des poulies spéciales, l'utilisation de poulies de série n'étant pas admise.

Para velocidades superiores a 30 m/seg., esto es, comprendidas en esta área, es necesario emplear poleas especiales. En estos casos no está permitido el uso de poleas de serie.

The pulleys included in this area are subjects to both of the restrictions listed above.

Die in diesem Bereich aufgeführten Riemenscheiben unterliegen beiden o.a. Einschränkungen.

Les poulies comprises dans cette plage sont soumises aux deux limitations mentionnées ci-dessus.

Las poleas comprendidas en esta área están sometidas a las dos limitaciones arriba indicadas.

## Prestazioni base cinghie AT 5 (Pb) / AT 5 (Pb) Basic belt performance Standardleistungen der Riemen AT 5 (Pb) Prestations de base des courroies AT 5 (Pb) / Prestaciones base correas AT 5 (Pb)

**TABELLA 13/1**  
(Valori per 10 mm di larghezza  
e ogni dente in presa) - kW<sup>3</sup>

**TABLE 13/1**  
(Calculated for 10 mm width  
with every tooth engaged) - kW<sup>3</sup>

**TABELLE 13/1**  
(Werte pro 10 mm - Breite und  
für jeden benutzten Zahn) - kW<sup>3</sup>

**TABLEAU 13/1**  
(Valeurs pour 10 mm de largeur  
et chaque dent en prise) - kW<sup>3</sup>

**TABLA 13/1**  
(Valores por 10 mm de ancho y  
cada diente en toma) - kW<sup>3</sup>

N. denti / N. of teeth / Zähnezahl N.bre de dents / Cantidad de dientes	12	14	15	16	18	20	22	24	26	28	30	32	36	40	42	44	48
100	0,003	0,003	0,003	0,004	0,004	0,004	0,005	0,005	0,006	0,006	0,007	0,007	0,008	0,009	0,009	0,010	0,011
200	0,005	0,006	0,006	0,006	0,007	0,008	0,009	0,010	0,011	0,011	0,012	0,013	0,015	0,016	0,017	0,018	0,020
300	0,007	0,008	0,009	0,009	0,010	0,012	0,013	0,014	0,015	0,016	0,017	0,019	0,021	0,023	0,024	0,026	0,028
400	0,009	0,010	0,011	0,012	0,013	0,015	0,016	0,018	0,019	0,021	0,022	0,024	0,027	0,030	0,031	0,033	0,036
500	0,011	0,013	0,013	0,014	0,016	0,018	0,020	0,022	0,023	0,025	0,027	0,029	0,032	0,036	0,038	0,040	0,043
600	0,013	0,015	0,016	0,017	0,019	0,021	0,023	0,025	0,027	0,029	0,032	0,034	0,038	0,042	0,044	0,046	0,051
725	0,015	0,017	0,018	0,020	0,022	0,025	0,027	0,030	0,032	0,035	0,037	0,040	0,045	0,049	0,052	0,054	0,059
800	0,016	0,019	0,020	0,022	0,024	0,027	0,030	0,032	0,035	0,038	0,040	0,043	0,048	0,054	0,057	0,059	0,065
900	0,018	0,021	0,022	0,024	0,027	0,030	0,033	0,036	0,039	0,042	0,045	0,048	0,054	0,059	0,062	0,065	0,071
1000	0,019	0,023	0,024	0,026	0,029	0,032	0,036	0,039	0,042	0,045	0,049	0,052	0,059	0,065	0,068	0,072	0,078
1100	0,021	0,025	0,026	0,028	0,032	0,035	0,039	0,042	0,045	0,049	0,053	0,056	0,063	0,070	0,074	0,077	0,085
1200	0,023	0,026	0,028	0,030	0,034	0,038	0,042	0,045	0,049	0,053	0,057	0,061	0,068	0,076	0,080	0,083	0,091
1300	0,024	0,028	0,030	0,032	0,036	0,040	0,045	0,049	0,053	0,057	0,061	0,065	0,073	0,081	0,085	0,089	0,097
1400	0,026	0,030	0,032	0,034	0,039	0,043	0,047	0,052	0,056	0,060	0,065	0,069	0,078	0,086	0,090	0,095	0,103
1425	0,026	0,031	0,033	0,035	0,039	0,044	0,048	0,052	0,056	0,061	0,066	0,070	0,079	0,087	0,092	0,096	0,105
1500	0,027	0,032	0,034	0,036	0,041	0,046	0,050	0,055	0,059	0,064	0,068	0,073	0,082	0,091	0,096	0,100	0,110
1600	0,029	0,034	0,036	0,038	0,043	0,048	0,053	0,058	0,062	0,067	0,072	0,077	0,087	0,096	0,101	0,106	0,116
1700	0,030	0,035	0,038	0,040	0,046	0,051	0,056	0,061	0,066	0,071	0,076	0,081	0,091	0,101	0,106	0,111	0,121
1800	0,032	0,037	0,040	0,042	0,048	0,053	0,058	0,064	0,069	0,074	0,080	0,085	0,096	0,106	0,111	0,117	0,127
1900	0,033	0,039	0,042	0,044	0,050	0,055	0,061	0,067	0,072	0,078	0,083	0,089	0,100	0,111	0,117	0,122	0,133
2000	0,035	0,040	0,043	0,046	0,052	0,058	0,064	0,069	0,075	0,081	0,087	0,093	0,104	0,116	0,122	0,127	0,139
2200	0,038	0,044	0,047	0,050	0,056	0,063	0,069	0,075	0,081	0,088	0,094	0,100	0,113	0,125	0,131	0,138	0,150
2400	0,040	0,047	0,050	0,054	0,060	0,067	0,074	0,081	0,087	0,094	0,101	0,108	0,121	0,134	0,141	0,148	0,161
2600	0,043	0,050	0,054	0,057	0,065	0,072	0,079	0,086	0,093	0,100	0,108	0,115	0,129	0,143	0,151	0,158	0,172
2800	0,046	0,053	0,057	0,061	0,069	0,076	0,084	0,091	0,099	0,107	0,114	0,122	0,137	0,152	0,160	0,168	0,183
2850	0,046	0,054	0,058	0,062	0,070	0,077	0,085	0,093	0,100	0,108	0,116	0,125	0,141	0,156	0,164	0,172	0,185
3000	0,048	0,056	0,060	0,064	0,072	0,081	0,089	0,097	0,105	0,113	0,121	0,129	0,145	0,161	0,169	0,177	0,193
3200	0,051	0,059	0,064	0,068	0,076	0,085	0,093	0,102	0,110	0,119	0,127	0,136	0,153	0,170	0,178	0,187	0,204
3400	0,053	0,062	0,067	0,071	0,080	0,089	0,098	0,107	0,116	0,125	0,134	0,143	0,160	0,178	0,187	0,196	0,214
3600	0,056	0,065	0,070	0,075	0,084	0,093	0,103	0,112	0,121	0,131	0,140	0,149	0,168	0,187	0,196	0,205	0,224
3800	0,058	0,068	0,073	0,078	0,088	0,097	0,107	0,117	0,126	0,136	0,146	0,156	0,175	0,195	0,205	0,214	0,234
4000	0,061	0,071	0,076	0,081	0,091	0,101	0,112	0,122	0,132	0,142	0,152	0,162	0,183	0,203	0,213	0,223	0,244
4200	0,063	0,074	0,079	0,084	0,095	0,105	0,116	0,127	0,137	0,148	0,158	0,169	0,190	0,211	0,222	0,232	0,253
4400	0,066	0,077	0,082	0,088	0,098	0,109	0,120	0,131	0,142	0,153	0,164	0,175	0,197	0,219	0,230	0,241	0,263
4600	0,068	0,079	0,085	0,091	0,102	0,113	0,125	0,136	0,147	0,159	0,170	0,181	0,204	0,227	0,238	0,249	0,272
4800	0,070	0,082	0,088	0,094	0,105	0,117	0,129	0,141	0,152	0,164	0,176	0,188	0,211	0,234	0,246	0,258	0,281
5000	0,073	0,085	0,091	0,097	0,109	0,121	0,133	0,145	0,157	0,169	0,182	0,194	0,218	0,242	0,254	0,266	0,291
5200	0,075	0,087	0,094	0,100	0,112	0,125	0,137	0,150	0,162	0,175	0,187	0,200	0,225	0,250	0,262	0,275	0,300
5400	0,077	0,090	0,096	0,103	0,116	0,129	0,141	0,154	0,167	0,180	0,193	0,206	0,232	0,257	0,270	0,283	0,309
5600	0,080	0,093	0,099	0,106	0,119	0,132	0,146	0,159	0,172	0,185	0,198	0,212	0,238	0,265	0,278	0,291	0,318
5800	0,082	0,095	0,102	0,109	0,122	0,136	0,150	0,163	0,176	0,190	0,204	0,218	0,245	0,272	0,286	0,299	0,327
6000	0,084	0,098	0,105	0,112	0,126	0,140	0,154	0,168	0,181	0,195	0,209	0,223	0,251	0,279	0,293	0,307	0,335
6500	0,089	0,104	0,111	0,119	0,134	0,148	0,163	0,178	0,192	0,207	0,222	0,237	0,267	0,297	0,311	0,326	0,356
7000	0,094	0,110	0,118	0,126	0,142	0,157	0,173	0,189	0,204	0,220	0,236	0,252	0,283	0,315	0,330	0,346	0,378
7500	0,100	0,116	0,124	0,133	0,149	0,166	0,182	0,199	0,215	0,232	0,249	0,265	0,299	0,332	0,348	0,365	0,398
8000	0,105	0,122	0,131	0,139	0,157	0,174	0,192	0,209	0,226	0,244	0,261	0,279	0,314	0,349	0,366	0,384	0,418
8500	0,109	0,128	0,137	0,146	0,164	0,183	0,201	0,219	0,237	0,256	0,274	0,292	0,329	0,365	0,383	0,402	0,438
9000	0,114	0,133	0,143	0,152	0,172	0,191	0,210	0,229	0,248	0,267	0,286	0,305	0,343	0,381	0,400	0,419	0,458
9500	0,119	0,139	0,149	0,159	0,179	0,199	0,218	0,238	0,258	0,278	0,298	0,318	0,357	0,397	0,417	0,437	0,477
10000	0,124	0,144	0,155	0,165	0,186	0,206	0,227	0,248	0,268	0,289	0,310	0,330	0,371	0,413	0,433	0,454	0,495
10500	0,128	0,149	0,160	0,171	0,192	0,214	0,235	0,257	0,278	0,299	0,321	0,342	0,385	0,428	0,449	0,471	0,513
11000	0,133	0,155	0,166	0,177	0,199	0,222	0,244	0,266	0,288	0,310	0,332	0,355	0,399	0,443	0,465	0,488	0,532
11500	0,137	0,160	0,171	0,183	0,206	0,229	0,252	0,275	0,297	0,320	0,343	0,366	0,412	0,458	0,480	0,504	0,549
12000	0,142	0,165	0,177	0,189	0,213	0,236	0,260	0,284	0,307	0,331	0,355	0,378	0,425	0,473	0,496	0,520	0,567
12500	0,146	0,170	0,182	0,195	0,219	0,243	0,268	0,292	0,316	0,341	0,365	0,389	0,438	0,487	0,511	0,536	0,584
13000	0,150	0,175	0,188	0,201	0,226	0,251	0,276	0,301	0,326	0,351	0,376	0,401	0,451	0,501	0,526	0,552	0,602
13500	0,154	0,180	0,193	0,206	0,232	0,258	0,283	0,309	0,334	0,360	0,386	0,412	0,463	0,515	0,541	0,567	0,618
14000	0,159	0,185	0,198	0,212	0,238	0,265	0,291	0,318	0,344	0,370	0,397	0,423	0,476	0,529	0,556	0,582	0,635
14500	0,163	0,190	0,203	0,217	0,244	0,271	0,298	0,326	0,352	0,379	0,407	0,434	0,488	0,542	0,570	0,597	0,651
15000	0,167	0,195	0,209	0,223	0,250	0,278	0,306	0,334	0,361	0,389	0,417	0,445	0,501	0,556	0,584	0,612	0,668

numero dei giri della puleggia minore / r.p.m. of smallest pulleys / Drehzahl der kleineren Reimenscheibe  
nombre de tours de la petite poulie / número de revoluciones por minuto de la polea menor

Le pulegge ed i numeri di giri corrispondenti a prestazioni comprese in quest'area possono venire impiegati solo se si accetta una riduzione di durata della cinghia.

The pulleys and RPMs corresponding to performance included in this area can be used only if a reduction in belt life is acceptable.

Die Riemenscheiben und die Anzahl der Umdrehungen, die den in diesem Bereich aufgeführten Leistungen entsprechen, können nur dann verwendet werden, wenn eine gewisse Minderung der Lebensdauer des Riemens in Kauf genommen wird.

Les poulies et les nombres de tours correspondant à des prestations comprises dans cette plage peuvent être utilisés uniquement si l'on accepte une réduction de durée de la courroie.

Las poleas y los números de revoluciones correspondientes a prestaciones comprendidas en esta área pueden ser empleadas sólo si se acepta una reducción de duración de la correa.

Per velocità superiori ai 30 m/sec., e cioè comprese in quest'area, è necessario impiegare pulegge speciali non essendo ammesso l'impiego di pulegge di serie.

# Prestazioni base cinghie AT 10 (Pb) / AT 10 (Pb) Basic belt performance

## Standardleistungen der Riemen AT 10 (Pb)

## Prestations de base des courroies AT 10 (Pb) / Prestaciones base correas AT 10 (Pb)



TABELLA 13/2

(Valori per 10 mm di larghezza e ogni dente in presa) - kW<sup>3</sup>

TABLE 13/2

(Calculated for 10 mm width with every tooth engaged) - kW<sup>3</sup>

TABELLE 13/2

(Werte pro 10 mm - Breite und für jeden benutzten Zahn) - kW<sup>3</sup>

TABLEAU 13/2

(Valeurs pour 10 mm de largeur et chaque dent en prise) - kW<sup>3</sup>

TABLA 13/2

(Valores por 10 mm de ancho y cada diente en toma) - kW<sup>3</sup>

N. denti / N. of teeth / Zähnezahl N.bre de dents / Cantidad de dientes	15	16	18	20	22	24	26	28	30	32	36	40	44	48
100	0,014	0,015	0,017	0,018	0,020	0,022	0,024	0,026	0,028	0,029	0,033	0,037	0,040	0,044
200	0,025	0,027	0,030	0,033	0,037	0,040	0,043	0,047	0,050	0,054	0,060	0,067	0,074	0,080
300	0,035	0,038	0,042	0,047	0,052	0,057	0,061	0,066	0,071	0,076	0,085	0,094	0,104	0,113
400	0,045	0,048	0,054	0,060	0,066	0,072	0,078	0,084	0,090	0,096	0,108	0,120	0,132	0,144
500	0,054	0,058	0,065	0,072	0,080	0,087	0,094	0,101	0,109	0,116	0,131	0,145	0,160	0,174
600	0,063	0,067	0,076	0,084	0,093	0,101	0,110	0,118	0,127	0,135	0,152	0,169	0,186	0,202
725	0,074	0,079	0,089	0,099	0,108	0,118	0,128	0,138	0,148	0,158	0,177	0,197	0,217	0,236
800	0,080	0,085	0,096	0,107	0,118	0,128	0,139	0,150	0,160	0,171	0,192	0,214	0,235	0,256
900	0,088	0,094	0,106	0,118	0,129	0,141	0,153	0,165	0,176	0,188	0,212	0,235	0,259	0,282
1000	0,096	0,102	0,115	0,128	0,141	0,154	0,167	0,179	0,192	0,205	0,231	0,256	0,282	0,308
1100	0,104	0,111	0,125	0,138	0,152	0,166	0,180	0,194	0,208	0,221	0,249	0,277	0,304	0,332
1200	0,111	0,119	0,134	0,148	0,163	0,178	0,193	0,208	0,223	0,238	0,267	0,297	0,327	0,356
1300	0,119	0,127	0,142	0,158	0,174	0,190	0,206	0,222	0,237	0,253	0,285	0,317	0,348	0,380
1400	0,126	0,134	0,151	0,168	0,185	0,201	0,218	0,235	0,252	0,269	0,302	0,336	0,369	0,403
1425	0,128	0,136	0,153	0,170	0,188	0,204	0,221	0,238	0,255	0,272	0,307	0,341	0,375	0,409
1500	0,133	0,142	0,160	0,177	0,195	0,213	0,231	0,248	0,266	0,284	0,319	0,355	0,390	0,426
1600	0,140	0,149	0,168	0,187	0,205	0,224	0,243	0,261	0,280	0,299	0,336	0,373	0,411	0,448
1700	0,147	0,157	0,176	0,196	0,215	0,235	0,255	0,274	0,294	0,313	0,353	0,392	0,431	0,470
1800	0,154	0,164	0,184	0,205	0,225	0,246	0,266	0,287	0,307	0,328	0,369	0,410	0,451	0,492
1900	0,160	0,171	0,192	0,214	0,235	0,256	0,278	0,299	0,321	0,342	0,385	0,428	0,470	0,513
2000	0,167	0,178	0,200	0,222	0,245	0,267	0,289	0,312	0,334	0,356	0,401	0,445	0,490	0,534
2200	0,180	0,192	0,216	0,240	0,264	0,288	0,312	0,336	0,359	0,383	0,431	0,479	0,527	0,575
2400	0,192	0,205	0,231	0,256	0,282	0,308	0,333	0,359	0,385	0,410	0,461	0,513	0,564	0,615
2600	0,204	0,218	0,245	0,273	0,300	0,327	0,354	0,382	0,409	0,436	0,491	0,545	0,600	0,654
2800	0,216	0,231	0,260	0,289	0,317	0,346	0,375	0,404	0,433	0,462	0,519	0,577	0,635	0,693
2850	0,218	0,234	0,263	0,292	0,322	0,351	0,380	0,409	0,439	0,468	0,526	0,585	0,643	0,702
3000	0,228	0,243	0,274	0,304	0,335	0,365	0,395	0,426	0,456	0,487	0,547	0,608	0,669	0,730
3200	0,240	0,255	0,287	0,319	0,351	0,383	0,415	0,447	0,479	0,511	0,575	0,639	0,703	0,767
3400	0,251	0,267	0,301	0,334	0,368	0,401	0,435	0,468	0,501	0,535	0,602	0,669	0,735	0,802
3600	0,262	0,279	0,314	0,349	0,384	0,419	0,454	0,489	0,523	0,558	0,628	0,698	0,768	0,838
3800	0,272	0,291	0,327	0,363	0,400	0,436	0,472	0,509	0,545	0,581	0,654	0,727	0,799	0,872
4000	0,283	0,302	0,340	0,377	0,415	0,453	0,491	0,528	0,566	0,604	0,679	0,755	0,830	0,906
4200	0,293	0,313	0,352	0,391	0,430	0,470	0,509	0,548	0,587	0,626	0,704	0,783	0,861	0,939
4400	0,304	0,324	0,364	0,405	0,445	0,486	0,526	0,567	0,607	0,648	0,729	0,810	0,891	0,972
4600	0,314	0,335	0,377	0,418	0,460	0,502	0,544	0,586	0,628	0,669	0,753	0,837	0,921	1,004
4800	0,324	0,345	0,388	0,432	0,475	0,518	0,561	0,604	0,647	0,691	0,777	0,863	0,950	1,036
5000	0,333	0,356	0,400	0,445	0,489	0,534	0,578	0,622	0,667	0,711	0,800	0,889	0,978	
5200	0,343	0,366	0,412	0,457	0,503	0,549	0,595	0,640	0,686	0,732	0,823	0,915	1,006	
5400	0,353	0,376	0,423	0,470	0,517	0,564	0,611	0,658	0,705	0,752	0,846	0,940	1,034	
5600	0,362	0,386	0,434	0,483	0,531	0,579	0,627	0,676	0,724	0,772	0,869	0,965	1,062	
5800	0,371	0,396	0,445	0,495	0,544	0,593	0,643	0,693	0,742	0,792	0,890	0,990		
6000	0,380	0,405	0,456	0,507	0,558	0,608	0,659	0,710	0,760	0,811	0,912	1,014		
6500	0,402	0,428	0,482	0,536	0,590	0,643	0,697	0,750	0,804	0,857	0,966			
7000	0,424	0,452	0,509	0,565	0,622	0,678	0,735	0,791	0,848	0,904				
7500	0,445	0,474	0,534	0,593	0,652	0,711	0,771	0,830	0,889	0,949				
8000	0,465	0,496	0,558	0,620	0,682	0,744	0,806	0,868	0,930	0,992				
8500	0,484	0,517	0,581	0,646	0,711	0,775	0,840	0,904	0,969	1,034				
9000	0,504	0,537	0,604	0,671	0,739	0,806	0,873	0,940	1,007					
9500	0,522	0,557	0,627	0,696	0,766	0,835	0,905	0,975						
10000	0,540	0,576	0,648	0,720	0,792	0,864	0,936							
10500	0,557	0,594	0,669	0,743	0,817	0,892								
11000	0,575	0,613	0,690	0,767	0,843	0,920								
11500	0,591	0,631	0,710	0,789	0,867	0,946								
12000	0,608	0,649	0,730	0,811	0,892	0,973								
12500	0,624	0,666	0,749	0,832	0,915	0,998								
13000	0,640	0,683	0,768	0,853	0,939	1,024								
13500	0,655	0,699	0,786	0,873	0,961	1,048								
14000	0,670	0,715	0,804	0,894	0,983	1,072								
14500	0,684	0,730	0,821	0,913	1,004	1,095								
15000	0,699	0,746	0,839	0,932	1,025	1,119								

numero dei giri della puleggia minore / r.p.m. of smallest pulleys / Drehzahl der kleineren Reimenscheibe  
nombre de tours de la petite poulie / número de revoluciones por minuto de la polea menor

The pulleys and RPMs corresponding to performance included in this area can be used only if a reduction in belt life is acceptable.

Die Riemenscheiben und die Anzahl der Umdrehungen, die den in diesem Bereich aufgeführten Leistungen entsprechen, können nur dann verwendet werden, wenn eine gewisse Minderung der Lebensdauer des Riemens in Kauf genommen wird.

Les poulies et les nombres de tours correspondant à des prestations comprises dans cette plage peuvent être utilisés uniquement si l'on accepte une réduction de durée de la courroie.

Las poleas y los números de revoluciones correspondientes a prestaciones comprendidas en esta área pueden ser empleadas sólo si se acepta una reducción de duración de la correa.

For speeds of over 30 m/sec, that is, included in this area, the use of special pulleys is required; the use of standard pulleys is not possible.

Für die in diesem Bereich aufgeführten Laufgeschwindigkeiten über 30 m/s müssen Spezial-Riemenscheiben eingesetzt werden (ein Einsatz der Standard- Riemenscheiben ist nicht möglich).

Pour des vitesses supérieures à 30 m/sec. et donc comprise dans cette plage, il est nécessaire d'utiliser des poulies spéciales, l'utilisation de poulies de série n'étant pas admise.

Para velocidades superiores a 30 m/seg., esto es, comprendidas en esta área, es necesario emplear poleas especiales. En estos casos no está permitido el uso de poleas de serie.

The pulleys included in this area are subjects to both of the restrictions listed above.

Die in diesem Bereich aufgeführten Riemenscheiben unterliegen beiden o.a. Einschränkungen.

Les poulies comprises dans cette plage sont soumises aux deux limitations mentionnées ci-dessus.

Las poleas comprendidas en esta área están sometidas a las dos limitaciones arriba indicadas.



**Pulegge trapezoidali per bussola conica**  
**V-Belt pulleys for taper bushes**  
**Keilriemenscheiben für spannbuchsen**  
**Poulies trapézoïdales à moyeu amovible**  
**Poleas trapezoidales**  
**para casquillos conicos (taper)**



Le pulegge per cinghie trapezoidali presentate dalla Sati SpA nel presente catalogo sono tutte costruite secondo le tabelle ISO 4183 e DIN 2211-3.

V-belt pulleys proposed by Sati SpA in this catalogue are all manufactured according to ISO 4183 and DIN 2211-3 norms.

Die Keilriemenscheiben, die von Sati SpA in diesem Katalog dargestellt sind, sind alle nach ISO 4183 und DIN 2211-3 hergestellt worden.

Les poulies trapézoïdales présentées par la Sati SpA sur ce catalogue sont toutes fabriquées suivant les normes ISO 4183 et DIN 2211-3.

Las poleas para correas trapezoidales presentadas por la Sati SpA en el presente catálogo están todas construidas según las tablas ISO 4183 y DIN 2211-3.

Il materiale impiegato nella costruzione delle medesime è in ghisa EN-GJL-200 UNI EN 1561 e, successivamente alle lavorazioni meccaniche, subiscono un trattamento superficiale di FOSFATAZIONE.

The material used for the construction of these pulleys is cast iron EN-GJL-200 UNI EN 1561 and after the machining all pulleys are being PHOSPHATED.

Das fuer die Produktion verwendete Material ist Grauguss EN-GJL-200 UNI EN 1561 und nach der Bearbeitung werden alle Keilriemenscheiben PHOSPHATIERT.

Le materiel utilisé pour la fabrication des poulies est la fonte EN-GJL-200 UNI EN 1561 et après l'usinage elles sont toutes exposées à un traitement de PHOSPHATATION.

El material empleado en la construcción de las mismas es el hierro fundido EN-GJL-200 UNI EN 1561 y después de las elaboraciones mecánicas están sometidas a un tratamiento superficial de FOSFATACIÓN.

Tutte le pulegge sono equilibrate STATICAMENTE ed idonee ad un funzionamento fino alla velocità periferica di 35 m/s.

All pulleys are STATICALLY balanced and suitable for peripheral speed up to 35 m/s.

Alle Keilriemenscheiben sind STATISCH ausgewuchtet und fuer eine peripherische Betriebsgeschwindigkeit bis 35 m/s.

Toutes les poulies sont équilibrées STATIQUEMENT et propres à tourner à une vitesse périphérique jusqu'à 35 m/s.

Todas las poleas están equilibradas ESTÁTICAMENTE y son adecuadas para un funcionamiento de una velocidad de hasta 35 m/s.

La gamma proposta nel seguente catalogo, comprende: PULEGGE TRAPEZOIDALI, per bussola conica, serie ZT..... AT..... BT..... CT..... PULEGGE TRAPEZOIDALI monoblocco (con mozzo pieno) serie ZM..... AM..... BM..... CM.....

The range proposed in this catalogue is the following: V-BELT PULLEYS for taper bush, series ZT..... AT..... BT..... CT..... V-BELT PULLEYS with solid hub, series ZM..... AM..... BM..... CM.....

Die in diesem Katalog angegebene Palette ist die folgende: KEILRIEMENSCHLEIBEN fuer Spannbuchse, Serie ZT..... AT..... BT..... CT..... KEILRIEMENSCHLEIBEN ungebohrt, Serie ZM..... AM..... BM..... CM.....

La gamme proposée dans ce catalogue est la suivante: POULIES TRAPEZOIDALES pour moyeu amovible, série ZT..... AT..... BT..... CT..... POULIES TRAPEZOIDALES à moyeu plein, série ZM..... AM..... BM..... CM.....

La gama propuesta en el siguiente catálogo comprende: POLEAS TRAPEZOIDALES para casquillos cónicos, serie ZT..... AT..... BT..... CT..... POLEAS TRAPEZOIDALES con cubo pleno, serie ZM..... AM..... BM..... CM.....

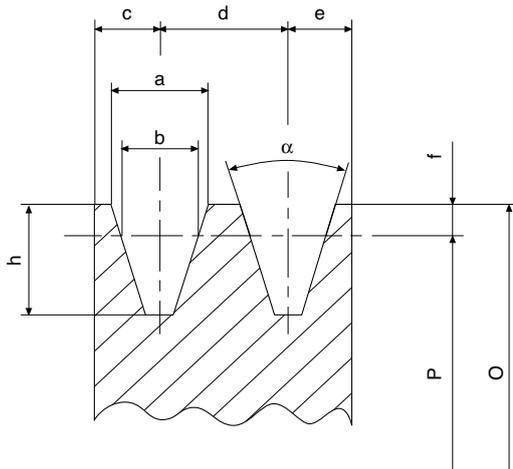

**Calcolo della velocità periferica Vp in m/s**  
**Calculation of peripheral speed Vp in m/s**  
**Berechnung der Umfangsgeschwindigkeit Vp in m/s**  
**Calcul de la vitesse périphérique Vp m/s**  
**Cálculo de la velocidad periférica Vp en m/s**

$$V_p = \frac{\pi \cdot P \cdot \text{rpm}}{60 \cdot 1000} \cong \frac{P \cdot \text{rpm}}{19100} \quad V_p \leq 35 \text{ m/s}$$

P = Diametro primitivo in mm  
 Pitch diameter in mm  
 Teildurchmesser in mm  
 Diamètre primitif en mm  
 Diámetro primitivo en mm

rpm = Giri al minuto  
 Revolutions per minute  
 Umdrehungen pro Minute  
 Tours par minute  
 Revoluciones por minuto

**Dimensioni puleggia    Pulley dimintions    Keilriemenscheibeabmessungen    Dimensions poulie    Dimensiones polea**

	a	b	c	d	e	f	h	34°	38°
<b>SPZ</b>	9,7	8,5	8,0	12,0	8,0	2,0	11,0	P <= 80	P > 80
<b>SPA</b>	12,7	11,0	10,0	15,0	10,0	2,8	13,8	P <= 118	P > 118
<b>SPB</b>	16,3	14,0	12,5	19,0	12,5	3,5	17,5	P <= 190	P > 190
<b>SPC</b>	22,0	19,0	17,0	25,5	17,0	4,8	23,8	P <= 315	P > 315

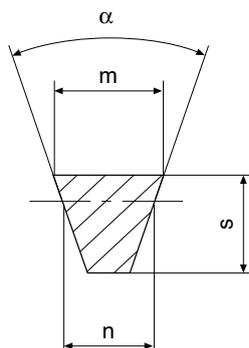

**Dimensioni cinghia / Belt dimintions / Riemenabmessungen**  
**Dimensions courroie / Dimensiones correa**

	m	s	n
<b>SPZ</b>	9,7	8	8,5
<b>SPA</b>	12,7	10	11,0
<b>SPB</b>	16,3	13	14,0
<b>SPC</b>	22,0	18	19,0

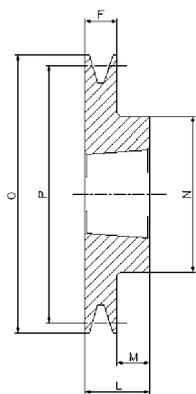

1

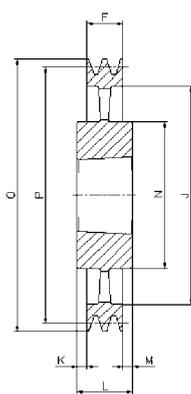

4

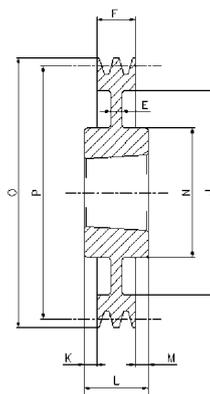

7

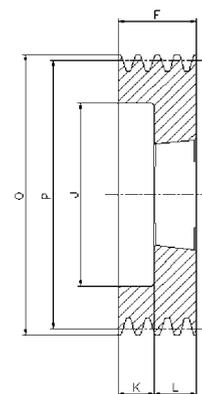

9

# SPZ/1

Cod. interno Internal code Innerer Code Code interne Código interno	Tipo Type Typ Type Tipo	Gole Grooves Rillen Gorges Canales	P	O	Forma Form Forme Forme Forma	Bussola Bush Buchse Moyeu Casquillo	∅ MAX	E	F	J	K	L	M	N
ZT00501	SPZ 50-01	1	50	54	9	1008	25	-	37	26	12,0	25	-	-
ZT00561	SPZ 56-01	1	56	60	9	1008	25	-	37	32	12,0	25	-	-
ZT00601	SPZ 60-01	1	60	64	1	1008	25	-	22	-	-	22	-	-
ZT00631	SPZ 63-01	1	63	67	1	1108	28	-	16	-	-	22	6,0	56
ZT00671	SPZ 67-01	1	67	71	1	1108	28	-	16	-	-	22	6,0	60
ZT00711	SPZ 71-01	1	71	75	1	1108	28	-	16	-	-	22	6,0	60
ZT00751	SPZ 75-01	1	75	79	1	1108	28	-	16	-	-	22	6,0	60
ZT00801	SPZ 80-01	1	80	84	1	1210	32	-	16	-	-	25	9,0	75
ZT00851	SPZ 85-01	1	85	89	1	1210	32	-	16	-	-	25	9,0	80
ZT00901	SPZ 90-01	1	90	94	1	1210	32	-	16	-	-	25	9,0	80
ZT00951	SPZ 95-01	1	95	99	1	1210	32	-	16	-	-	25	9,0	85
ZT01001	SPZ100-01	1	100	104	1	1210	32	-	16	-	-	25	9,0	85
ZT01061	SPZ106-01	1	106	110	1	1610	42	-	16	-	-	25	9,0	92
ZT01121	SPZ112-01	1	112	116	1	1610	42	-	16	-	-	25	9,0	92
ZT01181	SPZ118-01	1	118	122	1	1610	42	-	16	-	-	25	9,0	92
ZT01251	SPZ125-01	1	125	129	1	1610	42	-	16	-	-	25	9,0	92
ZT01321	SPZ132-01	1	132	136	1	1610	42	-	16	-	-	25	9,0	92
ZT01401	SPZ140-01	1	140	144	1	1610	42	-	16	-	-	25	9,0	92
ZT01501	SPZ150-01	1	150	154	1	1610	42	-	16	-	-	25	9,0	92
ZT01601	SPZ160-01	1	160	164	1	1610	42	-	16	-	-	25	9,0	92
ZT01701	SPZ170-01	1	170	174	1	1610	42	-	16	-	-	25	9,0	92
ZT01801	SPZ180-01	1	180	184	7	1610	42	6	16	152	-	25	9,0	92
ZT01901	SPZ190-01	1	190	194	7	1610	42	12	16	162	-	25	9,0	92
ZT02001	SPZ200-01	1	200	204	7	2012	50	10	16	171	-	32	16,0	112
ZT02241	SPZ224-01	1	224	228	7	2012	50	15	16	195	-	32	16,0	112
ZT02501	SPZ250-01	1	250	254	4	2012	50	-	16	221	8,0	32	8,0	112
ZT02801	SPZ280-01	1	280	284	4	2012	50	-	16	251	8,0	32	8,0	112
ZT03151	SPZ315-01	1	315	319	4	2012	50	-	16	286	8,0	32	8,0	112
ZT03551	SPZ355-01	1	355	359	4	2012	50	-	16	326	8,0	32	8,0	112
ZT04001	SPZ400-01	1	400	404	4	2012	50	-	16	371	8,0	32	8,0	112
ZT04501	SPZ450-01	1	450	454	4	2517	60	-	16	421	14,5	45	14,5	124

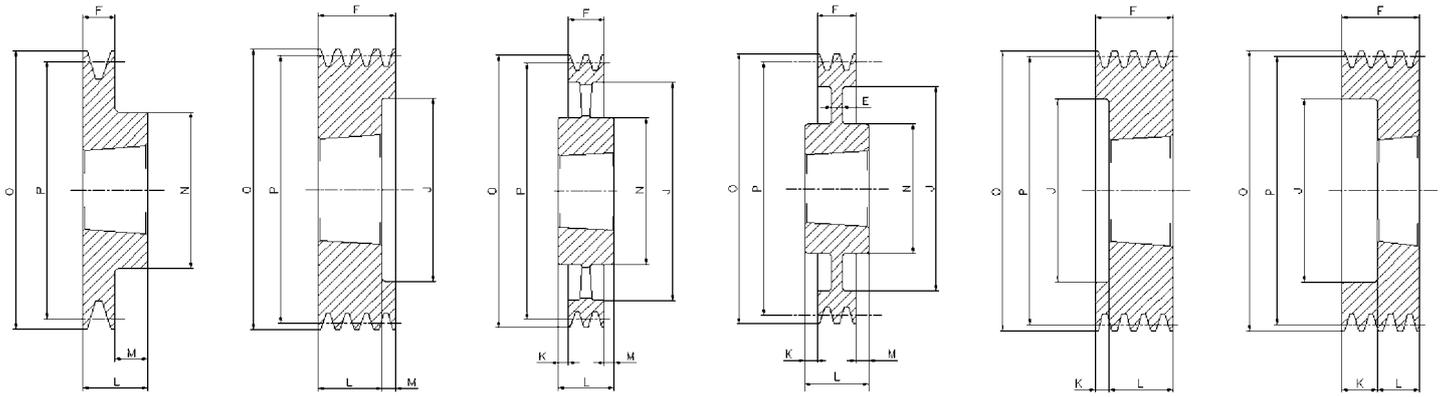
**1****2****4****7****8****9**

# SPZ/2

Cod. interno Internal code Innerer Code Code interne Código interno	Tipo Type Typ Type Tipo	Gole Grooves Rillen Gorges Canales	P	O	Forma Form Forme Forme Forma	Bussola Bush Buchse Moyeu Casquillo	Ø MAX	E	F	J	K	L	M	N
ZT00502	SPZ 50-02	2	<b>50</b>	54	9	1008	25	-	50	26	25,0	25	-	-
ZT00562	SPZ 56-02	2	<b>56</b>	60	9	1008	25	-	49	32	27,0	22	-	-
ZT00602	SPZ 60-02	2	<b>60</b>	64	9	1108	28	-	49	36	27,0	22	-	-
ZT00632	SPZ 63-02	2	<b>63</b>	67	8	1108	28	-	28	40	6,0	22	-	-
ZT00672	SPZ 67-02	2	<b>67</b>	71	8	1108	28	-	28	42	6,0	22	-	-
ZT00712	SPZ 71-02	2	<b>71</b>	75	8	1108	28	-	28	42	6,0	22	-	-
ZT00752	SPZ 75-02	2	<b>75</b>	79	8	1210	32	-	28	51	3,0	25	-	-
ZT00802	SPZ 80-02	2	<b>80</b>	84	8	1210	32	-	28	51	3,0	25	-	-
ZT00852	SPZ 85-02	2	<b>85</b>	89	8	1610	42	-	28	60	3,0	25	-	-
ZT00902	SPZ 90-02	2	<b>90</b>	94	8	1610	42	-	28	61	3,0	25	-	-
ZT00952	SPZ 95-02	2	<b>95</b>	99	8	1610	42	-	28	66	3,0	25	-	-
ZT01002	SPZ100-02	2	<b>100</b>	104	8	1610	42	-	28	71	3,0	25	-	-
ZT01062	SPZ106-02	2	<b>106</b>	110	8	1610	42	-	28	76	3,0	25	-	-
ZT01122	SPZ112-02	2	<b>112</b>	116	8	1610	42	-	28	83	3,0	25	-	-
ZT01182	SPZ118-02	2	<b>118</b>	122	8	1610	42	-	28	90	3,0	25	-	-
ZT01252	SPZ125-02	2	<b>125</b>	129	8	1610	42	-	28	96	3,0	25	-	-
ZT01322	SPZ132-02	2	<b>132</b>	136	8	1610	42	-	28	103	3,0	25	-	-
ZT01402	SPZ140-02	2	<b>140</b>	144	8	1610	42	-	28	111	3,0	25	-	-
ZT01502	SPZ150-02	2	<b>150</b>	154	1	2012	50	-	28	-	-	32	4,0	112
ZT01602	SPZ160-02	2	<b>160</b>	164	1	2012	50	-	28	-	-	32	4,0	112
ZT01702	SPZ170-02	2	<b>170</b>	174	1	2012	50	-	28	-	-	32	4,0	112
ZT01802	SPZ180-02	2	<b>180</b>	184	7	2012	50	6	28	152	-	32	4,0	112
ZT01902	SPZ190-02	2	<b>190</b>	194	7	2012	50	12	28	162	-	32	4,0	112
ZT02002	SPZ200-02	2	<b>200</b>	204	7	2012	50	6	28	171	-	32	4,0	112
ZT02242	SPZ224-02	2	<b>224</b>	228	4	2012	50	15	28	195	-	32	4,0	112
ZT02502	SPZ250-02	2	<b>250</b>	254	4	2012	50	-	28	221	2,0	32	2,0	112
ZT02802	SPZ280-02	2	<b>280</b>	284	4	2012	50	-	28	251	2,0	32	2,0	112
ZT03152	SPZ315-02	2	<b>315</b>	319	4	2012	50	-	28	286	2,0	32	2,0	112
ZT03552	SPZ355-02	2	<b>355</b>	359	4	2012	50	-	28	326	2,0	32	2,0	112
ZT04002	SPZ400-02	2	<b>400</b>	404	4	2517	60	-	28	371	8,5	45	8,5	124
ZT04502	SPZ450-02	2	<b>450</b>	454	4	2517	60	-	28	421	8,5	45	8,5	124



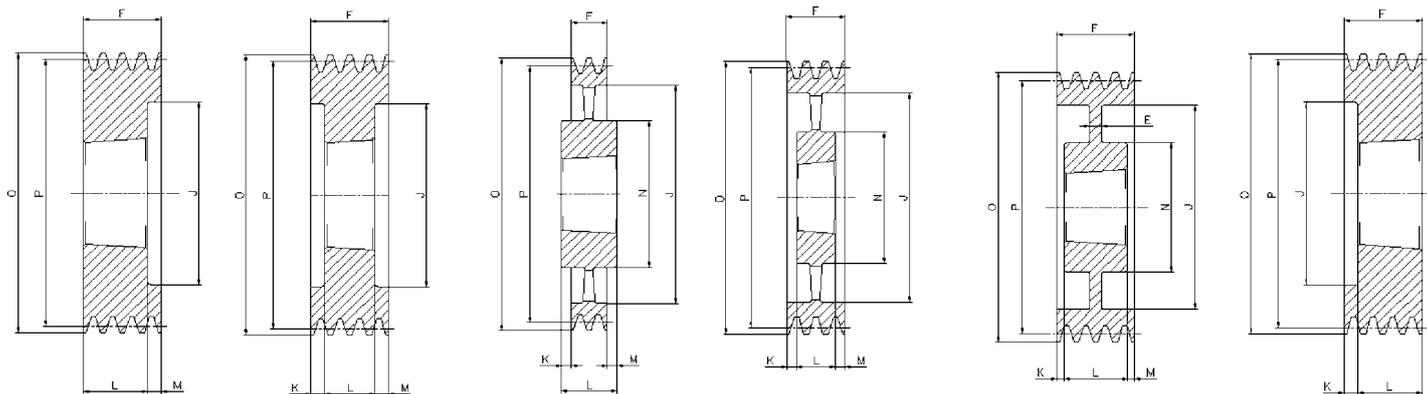

2

3

4

5

6

8

# SPZ/3

Cod. interno Internal code Innerer Code Code interne Código interno	Tipo Type Typ Type Tipo	Gole Grooves Rillen Gorges Canales	P	O	Forma Form Forme Forme Forma	Bussola Bush Buchse Moyeu Casquillo	Ø MAX	E	F	J	K	L	M	N
ZT00633	SPZ63-03	3	63	67	8	1108	28	-	40	40	-	22	-	-
ZT00673	SPZ67-03	3	67	71	8	1108	28	-	40	42	18,0	22	-	-
ZT00713	SPZ71-03	3	71	75	8	1108	28	-	40	42	18,0	22	-	-
ZT00753	SPZ75-03	3	75	79	8	1210	32	-	40	51	15,0	25	-	-
ZT00803	SPZ80-03	3	80	84	8	1210	32	-	40	51	15,0	25	-	-
ZT00853	SPZ85-03	3	85	89	8	1610	42	-	40	60	15,0	25	-	-
ZT00903	SPZ90-03	3	90	94	8	1610	42	-	40	61	15,0	25	-	-
ZT00953	SPZ95-03	3	95	99	8	1610	42	-	40	66	15,0	25	-	-
ZT01003	SPZ100-03	3	100	104	8	1610	42	-	40	71	15,0	25	-	-
ZT01063	SPZ106-03	3	106	110	8	1610	42	-	40	76	15,0	25	-	-
ZT01123	SPZ112-03	3	112	116	8	2012	50	-	40	83	8,0	32	-	-
ZT01183	SPZ118-03	3	118	122	8	2012	50	-	40	90	8,0	32	-	-
ZT01253	SPZ125-03	3	125	129	2	2012	50	-	40	96	-	32	8,0	-
ZT01323	SPZ132-03	3	132	136	2	2012	50	-	40	103	-	32	8,0	-
ZT01403	SPZ140-03	3	140	144	2	2012	50	-	40	111	-	32	8,0	-
ZT01503	SPZ150-03	3	150	154	2	2012	50	-	40	121	-	32	8,0	-
ZT01603	SPZ160-03	3	160	164	2	2012	50	-	40	131	-	32	8,0	-
ZT01703	SPZ170-03	3	170	174	3	2012	50	-	40	141	4,0	32	4,0	-
ZT01803	SPZ180-03	3	180	184	6	2012	50	7	40	151	-	32	8,0	106
ZT01903	SPZ190-03	3	190	194	6	2012	50	10	40	161	4,0	32	4,0	112
ZT02003	SPZ200-03	3	200	204	6	2012	50	10	40	171	4,0	32	4,0	112
ZT02243	SPZ224-03	3	224	228	6	2012	50	12	40	195	4,0	32	4,0	112
ZT02503	SPZ250-03	3	250	254	5	2012	50	-	40	221	4,0	32	4,0	112
ZT02803	SPZ280-03	3	280	284	4	2517	60	-	40	251	2,5	45	2,5	124
ZT03153	SPZ315-03	3	315	319	4	2517	60	-	40	286	2,5	45	2,5	124
ZT03553	SPZ355-03	3	355	359	4	2517	60	-	40	326	2,5	45	2,5	124
ZT04003	SPZ400-03	3	400	404	4	2517	60	-	40	371	2,5	45	2,5	124
ZT04503	SPZ450-03	3	450	454	4	2517	60	-	40	421	2,5	45	2,5	124
ZT05003	SPZ500-03	3	500	504	4	2517	60	-	40	471	2,5	45	2,5	124
ZT06303	SPZ630-03	3	630	634	4	3020	75	-	40	601	5,5	51	5,5	150
ZT08003	SPZ800-03	3	800	804	4	3020	75	-	40	771	5,5	51	5,5	146

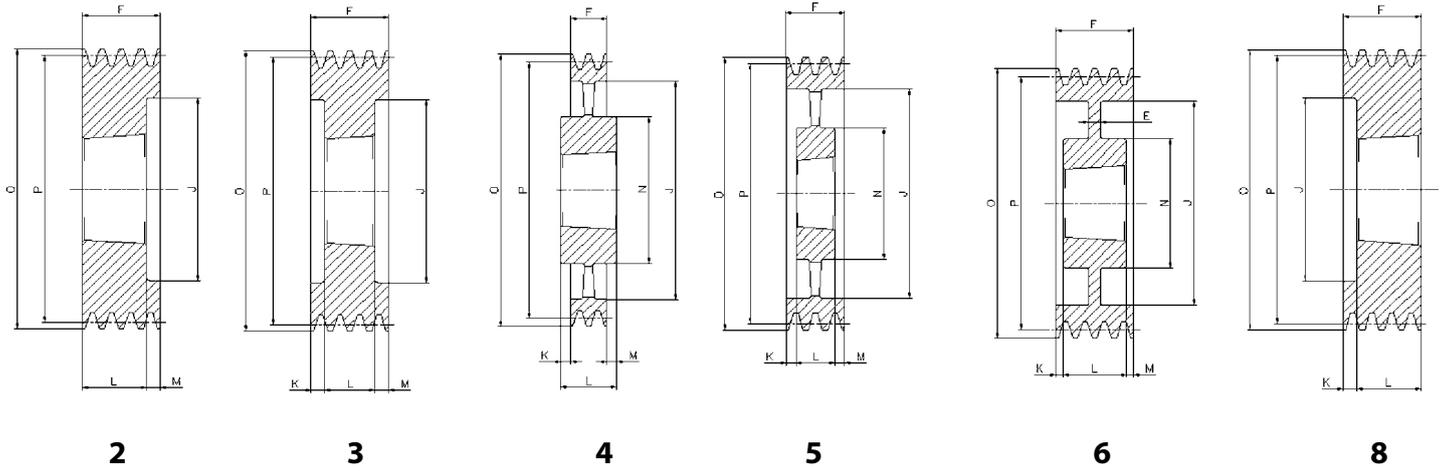

# SPZ/4

Cod. interno Internal code Innerer Code Code interne Código interno	Tipo Type Typ Type Tipo	Gole Grooves Rillen Gorges Canales	P	O	Forma Form Forme Forme Forma	Bussola Buchse Moyeu Casquillo	∅ MAX	E	F	J	K	L	M	N
ZT00804	SPZ 80-04	4	<b>80</b>	84	8	1210	32	-	52	51	27,0	25	-	-
ZT00854	SPZ 85-04	4	<b>85</b>	89	8	1610	42	-	52	60	27,0	25	-	-
ZT00904	SPZ 90-04	4	<b>90</b>	94	8	1610	42	-	52	61	27,0	25	-	-
ZT00954	SPZ 95-04	4	<b>95</b>	99	8	1610	42	-	52	66	27,0	25	-	-
ZT01004	SPZ100-04	4	<b>100</b>	104	8	1610	42	-	52	71	27,0	25	-	-
ZT01064	SPZ106-04	4	<b>106</b>	110	8	1610	42	-	52	76	27,0	25	-	-
ZT01124	SPZ112-04	4	<b>112</b>	116	8	2012	50	-	52	83	20,0	32	-	-
ZT01184	SPZ118-04	4	<b>118</b>	122	8	2012	50	-	52	90	20,0	32	-	-
ZT01254	SPZ125-04	4	<b>125</b>	129	2	2012	50	-	52	96	-	32	20,0	-
ZT01324	SPZ132-04	4	<b>132</b>	136	2	2012	50	-	52	103	-	32	20,0	-
ZT01404	SPZ140-04	4	<b>140</b>	144	2	2012	50	-	52	111	-	32	20,0	-
ZT01504	SPZ150-04	4	<b>150</b>	154	2	2517	60	-	52	121	-	45	7,0	-
ZT01604	SPZ160-04	4	<b>160</b>	164	2	2517	60	-	52	131	-	45	7,0	-
ZT01704	SPZ170-04	4	<b>170</b>	174	2	2517	60	-	52	141	-	45	7,0	-
ZT01804	SPZ180-04	4	<b>180</b>	184	2	2517	60	-	52	151	-	45	7,0	-
ZT01904	SPZ190-04	4	<b>190</b>	194	3	2517	60	-	52	161	3,5	45	3,5	-
ZT02004	SPZ200-04	4	<b>200</b>	204	6	2517	60	8	52	171	3,5	45	3,5	124
ZT02244	SPZ224-04	4	<b>224</b>	228	6	2517	60	14	52	195	3,5	45	3,5	124
ZT02504	SPZ250-04	4	<b>250</b>	254	6	2517	60	12	52	221	3,5	45	3,5	124
ZT02804	SPZ280-04	4	<b>280</b>	284	6	2517	60	14	52	251	3,5	45	3,5	124
ZT03154	SPZ315-04	4	<b>315</b>	319	5	2517	60	-	52	286	3,5	45	3,5	124
ZT03554	SPZ355-04	4	<b>355</b>	359	5	2517	60	-	52	326	3,5	45	3,5	124
ZT04004	SPZ400-04	4	<b>400</b>	404	5	2517	60	-	52	371	3,5	45	3,5	124
ZT04504	SPZ450-04	4	<b>450</b>	454	5	3020	75	-	52	421	0,5	51	0,5	146
ZT05004	SPZ500-04	4	<b>500</b>	504	5	3020	75	-	52	471	0,5	51	0,5	146
ZT06304	SPZ630-04	4	<b>630</b>	634	4	3030	75	-	52	601	12,0	76	12,0	146
ZT08004	SPZ800-04	4	<b>800</b>	804	4	3030	75	-	52	771	12,0	76	12,0	146

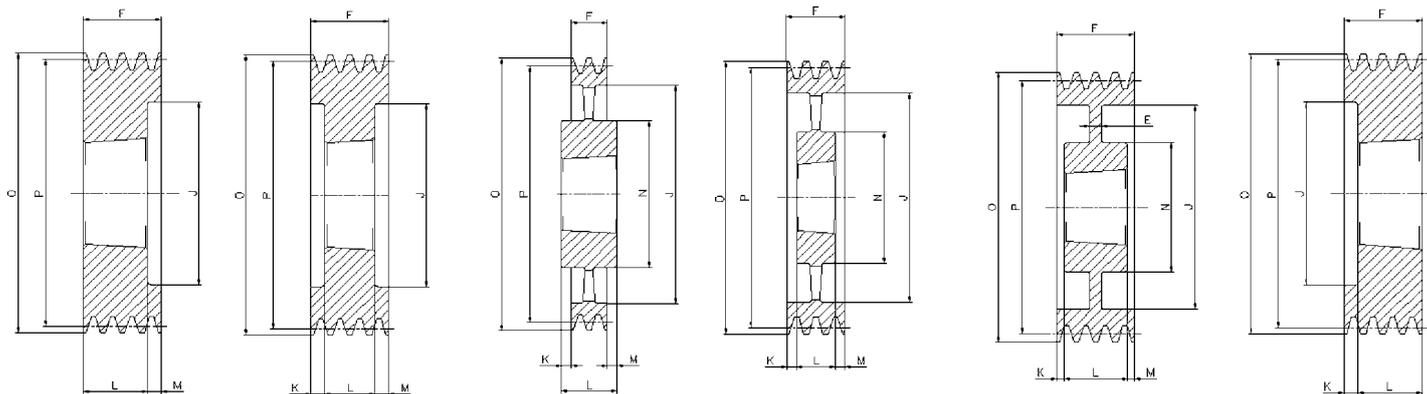

2

3

4

5

6

8

# SPZ/5

Cod. interno Internal code Inner Code Code interne Código interno	Tipo Type Typ Type Tipo	Gole Grooves Rillen Gorges Canales	P	O	Forma Form Forme Forme Forma	Bussola Bush Buchse Moyeu Casquillo	∅ MAX	E	F	J	K	L	M	N
ZT00855	SPZ 85-05	5	85	89	8	1610	42	-	64	60	39,0	25	-	-
ZT00905	SPZ 90-05	5	90	94	8	1610	42	-	64	61	39,0	25	-	-
ZT00955	SPZ 95-05	5	95	99	8	1610	42	-	64	66	39,0	25	-	-
ZT01005	SPZ100-05	5	100	104	8	2012	50	-	64	71	32,0	32	-	-
ZT01065	SPZ106-05	5	106	110	8	2012	50	-	64	76	32,0	32	-	-
ZT01125	SPZ112-05	5	112	116	8	2012	50	-	64	83	32,0	32	-	-
ZT01185	SPZ118-05	5	118	122	8	2012	50	-	64	90	32,0	32	-	-
ZT01255	SPZ125-05	5	125	129	8	2012	50	-	64	96	32,0	32	-	-
ZT01325	SPZ132-05	5	132	136	8	2517	60	-	64	103	19,0	45	19,0	-
ZT01405	SPZ140-05	5	140	144	2	2517	60	-	64	111	-	45	19,0	-
ZT01505	SPZ150-05	5	150	154	2	2517	60	-	64	121	-	45	19,0	-
ZT01605	SPZ160-05	5	160	164	2	2517	60	-	64	131	-	45	19,0	-
ZT01705	SPZ170-05	5	170	174	2	2517	60	-	64	141	-	45	19,0	-
ZT01805	SPZ180-05	5	180	184	2	2517	60	-	64	151	-	45	19,0	-
ZT01905	SPZ190-05	5	190	194	3	2517	60	-	64	161	9,5	45	9,5	-
ZT02005	SPZ200-05	5	200	204	3	2517	60	-	64	171	9,5	45	9,5	-
ZT02245	SPZ224-05	5	224	228	6	2517	60	20	64	195	9,5	45	9,5	124
ZT02505	SPZ250-05	5	250	254	6	2517	60	16	64	221	9,5	45	9,5	124
ZT02805	SPZ280-05	5	280	284	6	2517	60	15	64	251	9,5	45	9,5	124
ZT03155	SPZ315-05	5	315	319	5	2517	60	-	64	286	9,5	45	9,5	124
ZT03555	SPZ355-05	5	355	359	5	2517	60	-	64	326	9,5	45	9,5	124
ZT04005	SPZ400-05	5	400	404	5	3020	75	-	64	371	6,5	51	6,5	146
ZT04505	SPZ450-05	5	450	454	5	3020	75	-	64	421	6,5	51	6,5	146
ZT05005	SPZ500-05	5	500	504	4	3030	75	-	64	471	6,0	76	6,0	146
ZT06305	SPZ630-05	5	630	634	4	3030	75	-	64	601	6,0	76	6,0	146
ZT08005	SPZ800-05	5	800	804	4	3535	90	-	64	771	12,5	89	12,5	178

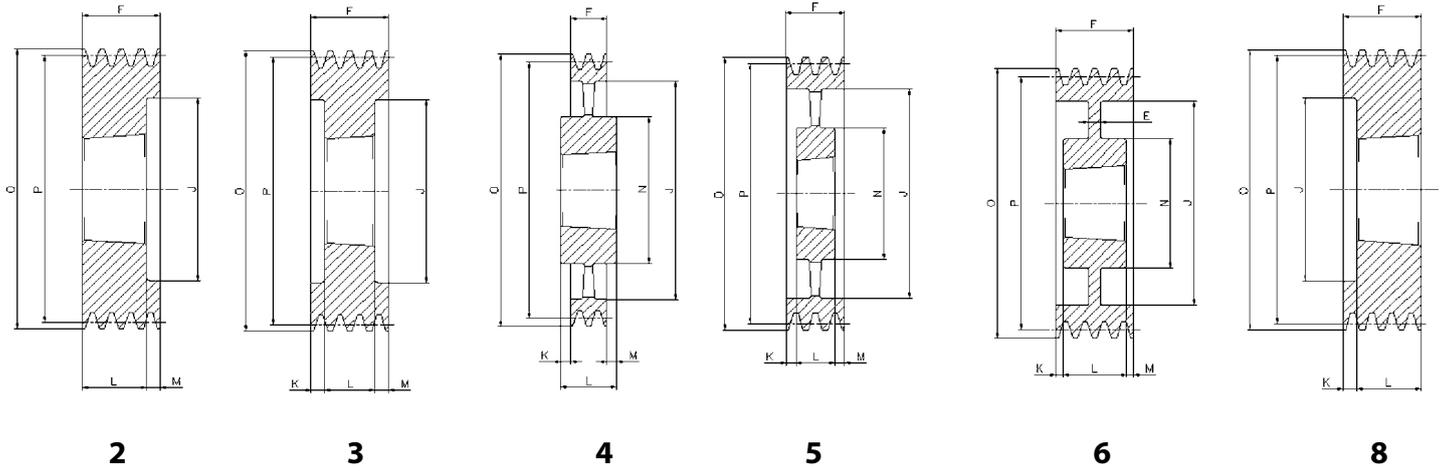

# SPZ/6

Cod. interno Internal code Innerer Code Code interne Código interno	Tipo Type Typ Type Tipo	Gole Grooves Rillen Gorges Canales	P	O	Forma Form Forme Forme Forma	Bussola Bush Buchse Moyeu Casquillo	∅ MAX	E	F	J	K	L	M	N
ZT00906	SPZ 90-06	6	<b>90</b>	94	8	1610	42	-	76	61	51,0	25	-	-
ZT00956	SPZ 95-06	6	<b>95</b>	99	8	1610	42	-	76	66	51,0	25	-	-
ZT01006	SPZ100-06	6	<b>100</b>	104	8	2012	50	-	76	71	44,0	32	-	-
ZT01066	SPZ106-06	6	<b>106</b>	110	8	2012	50	-	76	76	44,0	32	-	-
ZT01126	SPZ112-06	6	<b>112</b>	116	8	2012	50	-	76	83	44,0	32	-	-
ZT01186	SPZ118-06	6	<b>118</b>	122	8	2517	60	-	76	90	31,0	45	-	-
ZT01256	SPZ125-06	6	<b>125</b>	129	8	2517	60	-	76	96	31,0	45	-	-
ZT01326	SPZ132-06	6	<b>132</b>	136	8	2517	60	-	76	103	31,0	45	-	-
ZT01406	SPZ140-06	6	<b>140</b>	144	2	2517	60	-	76	111	-	45	31,0	-
ZT01506	SPZ150-06	6	<b>150</b>	154	2	2517	60	-	76	121	-	45	31,0	-
ZT01606	SPZ160-06	6	<b>160</b>	164	2	2517	60	-	76	131	-	45	31,0	-
ZT01706	SPZ170-06	6	<b>170</b>	174	2	2517	60	-	76	141	-	45	31,0	-
ZT01806	SPZ180-06	6	<b>180</b>	184	3	2517	60	-	76	151	15,5	45	15,5	-
ZT01906	SPZ190-06	6	<b>190</b>	194	3	2517	60	-	76	161	15,5	45	15,5	124
ZT02006	SPZ200-06	6	<b>200</b>	204	3	2517	60	-	76	171	15,5	45	15,5	124
ZT02246	SPZ224-06	6	<b>224</b>	228	6	2517	60	26	76	195	15,5	45	15,5	124
ZT02506	SPZ250-06	6	<b>250</b>	254	6	2517	60	26	76	221	15,5	45	15,5	124
ZT02806	SPZ280-06	6	<b>280</b>	284	6	2517	60	15	76	251	15,5	45	15,5	124
ZT03156	SPZ315-06	6	<b>315</b>	319	6	2517	60	15	76	286	15,5	45	15,5	124
ZT03556	SPZ355-06	6	<b>355</b>	359	5	2517	60	-	76	326	15,5	45	15,5	124
ZT04006	SPZ400-06	6	<b>400</b>	404	5	3030	75	-	76	371	-	76	-	146
ZT04506	SPZ450-06	6	<b>450</b>	454	5	3030	75	-	76	421	-	76	-	146
ZT05006	SPZ500-06	6	<b>500</b>	504	5	3030	75	-	76	471	-	76	-	146
ZT06306	SPZ630-06	6	<b>630</b>	634	4	3535	90	-	76	601	6,5	89	6,5	175
ZT08006	SPZ800-06	6	<b>800</b>	804	4	3535	90	-	76	771	6,5	89	6,5	178

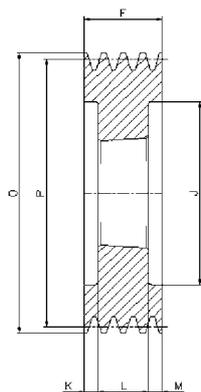

3

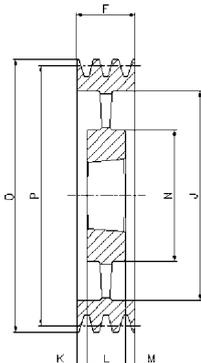

5

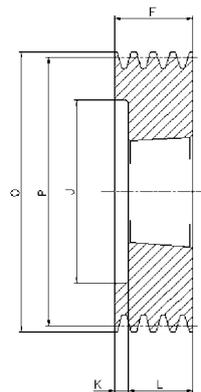

8

# SPZ/8

Cod. interno Internal code Innerer Code Code interne Código interno	Tipo Type Typ Type Tipo	Gole Grooves Rillen Gorges Canales	P	O	Forma Form Forme Forme Forma	Bussola Bush Buchse Moyeu Casquillo	∅ MAX	E	F	J	K	L	M	N
ZT01408	SPZ140-08	8	140	144	3	2517	60	-	100	111	27,5	45	27,5	-
ZT01508	SPZ150-08	8	150	154	3	2517	60	-	100	121	27,5	45	27,5	-
ZT01608	SPZ160-08	8	160	164	3	2517	60	-	100	131	27,5	45	27,5	-
ZT01808	SPZ180-08	8	180	184	3	2517	60	-	100	151	27,5	45	27,5	-
ZT02008	SPZ200-08	8	200	204	3	3020	75	-	100	171	24,5	51	24,5	-
ZT02248	SPZ224-08	8	224	228	3	3020	75	-	100	195	24,5	51	24,5	-
ZT02508	SPZ250-08	8	250	254	6	3020	75	20	100	221	24,5	51	24,5	146
ZT02808	SPZ280-08	8	280	284	6	3020	75	20	100	251	24,5	51	24,5	146
ZT03558	SPZ355-08	8	355	359	5	3030	75	-	100	326	12,5	76	12,5	146
ZT04008	SPZ400-08	8	400	404	5	3030	75	-	100	371	12,5	76	12,5	146
ZT04508	SPZ450-08	8	450	454	5	3535	90	-	100	421	5,5	89	5,5	175

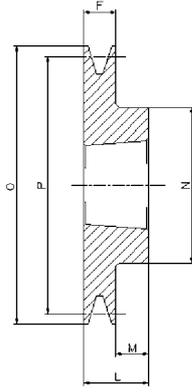

1

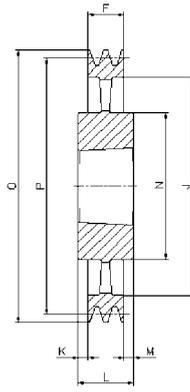

4

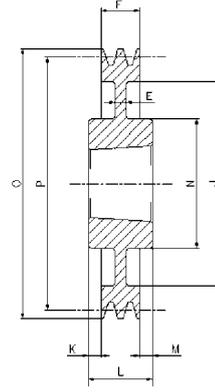

7

# SPA/1

Cod. interno Internal code Innerer Code Code interne Código interno	Tipo Type Typ Type Tipo	Gole Grooves Rillen Gorges Canales	P	O	Forma Form Forme Forme Forma	Bussola Bush Buchse Moyeu Casquillo	Ø MAX	E	F	J	K	L	M	N
AT00631	SPA 63-01	1	<b>63</b>	68,5	1	1008	25	-	20	-	-	22	2	56
AT00671	SPA 67-01	1	<b>67</b>	72,5	1	1108	28	-	20	-	-	22	2	56
AT00711	SPA 71-01	1	<b>71</b>	76,5	1	1108	28	-	20	-	-	22	2	60
AT00751	SPA 75-01	1	<b>75</b>	80,5	1	1108	28	-	20	-	-	22	2	56
AT00801	SPA 80-01	1	<b>80</b>	85,5	1	1210	32	-	20	-	-	25	5	75
AT00851	SPA 85-01	1	<b>85</b>	90,5	1	1210	32	-	20	-	-	25	5	80
AT00901	SPA 90-01	1	<b>90</b>	95,5	1	1210	32	-	20	-	-	25	5	80
AT00951	SPA 95-01	1	<b>95</b>	100,5	1	1210	32	-	20	-	-	25	5	85
AT01001	SPA100-01	1	<b>100</b>	105,5	1	1610	42	-	20	-	-	25	5	85
AT01061	SPA106-01	1	<b>106</b>	111,5	1	1610	42	-	20	-	-	25	5	92
AT01121	SPA112-01	1	<b>112</b>	117,5	1	1610	42	-	20	-	-	25	5	92
AT01181	SPA118-01	1	<b>118</b>	123,5	1	1610	42	-	20	-	-	25	5	92
AT01251	SPA125-01	1	<b>125</b>	130,5	1	1610	42	-	20	-	-	25	5	92
AT01321	SPA132-01	1	<b>132</b>	137,5	1	1610	42	-	20	-	-	25	5	92
AT01401	SPA140-01	1	<b>140</b>	145,5	1	1610	42	-	20	-	-	25	5	92
AT01501	SPA150-01	1	<b>150</b>	155,5	1	1610	42	-	20	-	-	25	5	92
AT01601	SPA160-01	1	<b>160</b>	165,5	1	1610	42	-	20	-	-	25	5	92
AT01701	SPA170-01	1	<b>170</b>	175,5	1	1610	42	-	20	-	-	25	5	92
AT01801	SPA180-01	1	<b>180</b>	185,5	7	1610	42	6	20	145	-	25	5	92
AT01901	SPA190-01	1	<b>190</b>	195,5	7	1610	42	6	20	156	-	25	5	92
AT02001	SPA200-01	1	<b>200</b>	205,5	7	2012	50	6	20	165	-	32	12	108
AT02121	SPA212-01	1	<b>212</b>	217,5	7	2012	50	10	20	177	-	32	12	110
AT02241	SPA224-01	1	<b>224</b>	229,5	7	2012	50	10	20	189	-	32	12	112
AT02361	SPA236-01	1	<b>236</b>	241,5	7	2012	50	10	20	202	-	32	12	112
AT02501	SPA250-01	1	<b>250</b>	255,5	7	2012	50	10	20	215	6	32	6	112
AT02801	SPA280-01	1	<b>280</b>	285,5	7	2012	50	10	20	245	-	32	12	112
AT03001	SPA300-01	1	<b>300</b>	305,5	7	2012	50	12	20	265	-	32	12	112
AT03151	SPA315-01	1	<b>315</b>	320,5	7	2012	50	12	20	280	-	32	12	112
AT03551	SPA355-01	1	<b>355</b>	360,5	4	2012	50	-	20	320	-	32	12	112
AT04001	SPA400-01	1	<b>400</b>	405,5	4	2012	50	-	20	365	-	32	12	112
AT04501	SPA450-01	1	<b>450</b>	455,5	4	2012	50	-	20	415	-	32	12	112
AT05001	SPA500-01	1	<b>500</b>	505,5	4	2517	60	-	20	465	-	45	25	124
AT06301	SPA630-01	1	<b>630</b>	635,5	4	2517	60	-	20	595	-	45	25	124

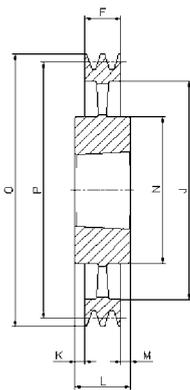

4

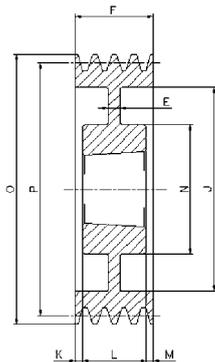

6

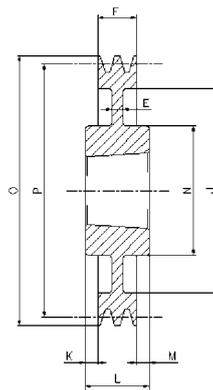

7

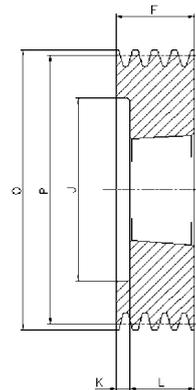

8

# SPA/2

Cod. interno Internal code Innerer Code Code interne Còdigo interno	Tipo Type Typ Type Tipo	Gole Grooves Rillen Gorges Canales	P	O	Forma Form Forme Forme Forma	Bussola Bush Buchse Moyeu Casquillo	Ø MAX	E	F	J	K	L	M	N
AT00632	SPA 63-02	2	63	68,5	8	1008	28	-	35	32,5	13,0	22	-	-
AT00672	SPA 67-02	2	67	72,5	8	1108	28	-	35	37,0	13,0	22	-	-
AT00712	SPA 71-02	2	71	76,5	8	1108	28	-	35	40,0	13,0	22	-	-
AT00752	SPA 75-02	2	75	80,5	8	1108	28	-	35	44,0	13,0	22	-	-
AT00802	SPA 80-02	2	80	85,5	8	1210	32	-	35	50,0	10,0	25	-	-
AT00852	SPA 85-02	2	85	90,5	8	1210	32	-	35	55,0	10,0	25	-	-
AT00902	SPA 90-02	2	90	95,5	8	1610	42	-	35	59,0	10,0	25	-	-
AT00952	SPA 95-02	2	95	100,5	8	1610	42	-	35	63,0	10,0	25	-	-
AT01002	SPA100-02	2	100	105,5	8	1610	42	-	35	66,0	10,0	25	-	-
AT01062	SPA106-02	2	106	111,5	8	1610	42	-	35	72,0	10,0	25	-	-
AT01122	SPA112-02	2	112	117,5	8	1610	42	-	35	78,0	10,0	25	-	-
AT01182	SPA118-02	2	118	123,5	8	1610	42	-	35	84,0	10,0	25	-	-
AT01252	SPA125-02	2	125	130,5	8	1610	42	-	35	91,0	10,0	25	-	-
AT01322	SPA132-02	2	132	137,5	8	2012	50	-	35	98,0	3,0	32	-	-
AT01402	SPA140-02	2	140	145,5	8	2012	50	-	35	106,0	3,0	32	-	-
AT01502	SPA150-02	2	150	155,5	8	2012	50	-	35	116,0	3,0	32	-	-
AT01602	SPA160-02	2	160	165,5	8	2012	50	-	35	125,0	3,0	32	-	-
AT01702	SPA170-02	2	170	175,5	8	2012	50	-	35	135,0	3,0	32	-	-
AT01802	SPA180-02	2	180	185,5	6	2012	50	10	35	146,0	1,5	32	1,5	108
AT01902	SPA190-02	2	190	195,5	6	2012	50	10	35	156,0	1,5	32	1,5	108
AT02002	SPA200-02	2	200	205,5	7	2517	60	10	35	165,0	5,0	45	5,0	123
AT02122	SPA212-02	2	212	217,5	7	2517	60	18	35	177,0	5,0	45	5,0	123
AT02242	SPA224-02	2	224	229,5	7	2517	60	18	35	189,0	-	45	10,0	124
AT02362	SPA236-02	2	236	241,5	7	2517	60	12	35	202,0	-	45	10,0	124
AT02502	SPA250-02	2	250	255,5	7	2517	60	12	35	215,0	5,0	45	5,0	124
AT02802	SPA280-02	2	280	285,5	7	2517	60	12	35	245,0	-	45	10,0	124
AT03002	SPA300-02	2	300	305,5	7	2517	60	12	35	265,0	-	45	10,0	124
AT03152	SPA315-02	2	315	320,5	7	2517	60	12	35	280,0	-	45	10,0	124
AT03552	SPA355-02	2	355	360,5	4	2517	60	-	35	320,0	-	45	10,0	124
AT04002	SPA400-02	2	400	405,5	4	2517	60	-	35	365,0	-	45	10,0	124
AT04502	SPA450-02	2	450	455,5	4	2517	60	-	35	465,0	-	45	10,0	124
AT05002	SPA500-02	2	500	505,5	4	2517	60	-	35	525,0	-	45	10,0	125
AT06302	SPA630-02	2	630	635,5	4	3020	75	-	35	595,0	8,0	51	18,0	159

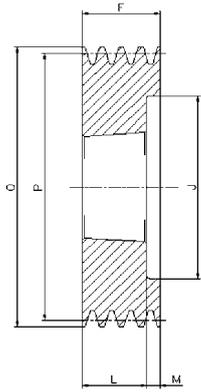

2

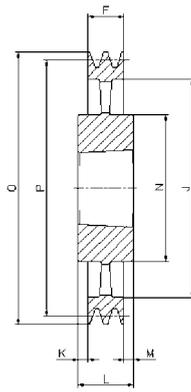

4

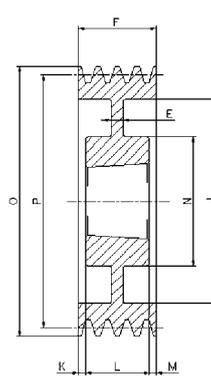

6

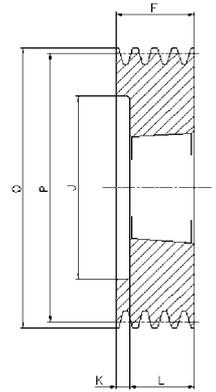

8

# SPA/3

Cod. interno Internal code Innerer Code Code interne Código interno	Tipo Type Typ Type Tipo	Gole Grooves Rillen Gorges Canales	P	O	Forma Form Forme Forme Forma	Bussola Buchse Moyeu Casquillo	∅ MAX	E	F	J	K	L	M	N
AT00713	SPA 71-03	3	71	76,5	8	1108	28	-	50	40	28,0	22	-	-
AT00753	SPA 75-03	3	75	80,5	8	1108	28	-	50	44	28,0	22	-	-
AT00803	SPA 80-03	3	80	85,5	8	1210	32	-	50	50	25,0	25	-	-
AT00853	SPA 85-03	3	85	90,5	8	1210	32	-	50	55	25,0	25	-	-
AT00903	SPA 90-03	3	90	95,5	8	1610	42	-	50	59	25,0	25	-	-
AT00953	SPA 95-03	3	95	100,5	8	1610	42	-	50	63	25,0	25	-	-
AT01003	SPA100-03	3	100	105,5	2	1610	42	-	50	66	-	25	25,0	-
AT01063	SPA106-03	3	106	111,5	2	1610	42	-	50	72	-	25	25,0	-
AT01123	SPA112-03	3	112	117,5	8	2012	50	-	50	78	18,0	32	-	-
AT01183	SPA118-03	3	118	123,5	2	2012	50	-	50	84	-	32	18,0	-
AT01253	SPA125-03	3	125	130,5	2	2012	50	-	50	91	-	32	18,0	-
AT01323	SPA132-03	3	132	137,5	2	2012	50	-	50	98	-	32	18,0	-
AT01403	SPA140-03	3	140	145,5	8	2517	60	-	50	106	5,0	45	-	-
AT01503	SPA150-03	3	150	155,5	8	2517	60	-	50	116	5,0	45	-	-
AT01603	SPA160-03	3	160	165,5	8	2517	60	-	50	125	5,0	45	-	-
AT01703	SPA170-03	3	170	175,5	8	2517	60	-	50	135	5,0	45	-	-
AT01803	SPA180-03	3	180	185,5	8	2517	60	-	50	146	5,0	45	-	-
AT01903	SPA190-03	3	190	195,5	8	2517	60	-	50	156	5,0	45	-	-
AT02003	SPA200-03	3	200	205,5	6	2517	60	20	50	165	2,5	45	2,5	123
AT02123	SPA212-03	3	212	217,5	6	2517	60	20	50	177	2,5	45	2,5	123
AT02243	SPA224-03	3	224	229,5	6	2517	60	20	50	189	2,5	45	2,5	124
AT02363	SPA236-03	3	236	241,5	6	2517	60	20	50	202	2,5	45	2,5	124
AT02503	SPA250-03	3	250	255,5	6	2517	60	20	50	215	2,5	45	2,5	124
AT02803	SPA280-03	3	280	285,5	6	2517	60	20	50	245	2,5	45	2,5	124
AT03003	SPA300-03	3	300	305,5	4	3020	75	-	50	265	0,5	51	0,5	146
AT03153	SPA315-03	3	315	320,5	4	3020	75	-	50	280	0,5	51	0,5	159
AT03553	SPA355-03	3	355	360,5	4	3020	75	-	50	320	0,5	51	0,5	159
AT04003	SPA400-03	3	400	405,5	4	3020	75	-	50	365	-	51	1,0	159
AT04503	SPA450-03	3	450	455,5	4	3020	75	-	50	415	-	51	1,0	159
AT05003	SPA500-03	3	500	505,5	4	3020	75	-	50	465	-	51	1,0	159
AT05603	SPA560-03	3	560	565,5	4	3020	75	-	50	525	-	51	1,0	150
AT06303	SPA630-03	3	630	635,5	4	3020	75	-	50	595	-	51	1,0	150
AT08003	SPA800-03	3	800	805,5	4	3535	90	-	50	765	19,5	89	19,5	175
AT10003	SPA1000-03	3	1000	1005,5	4	3535	90	-	50	965	19,5	89	19,5	175



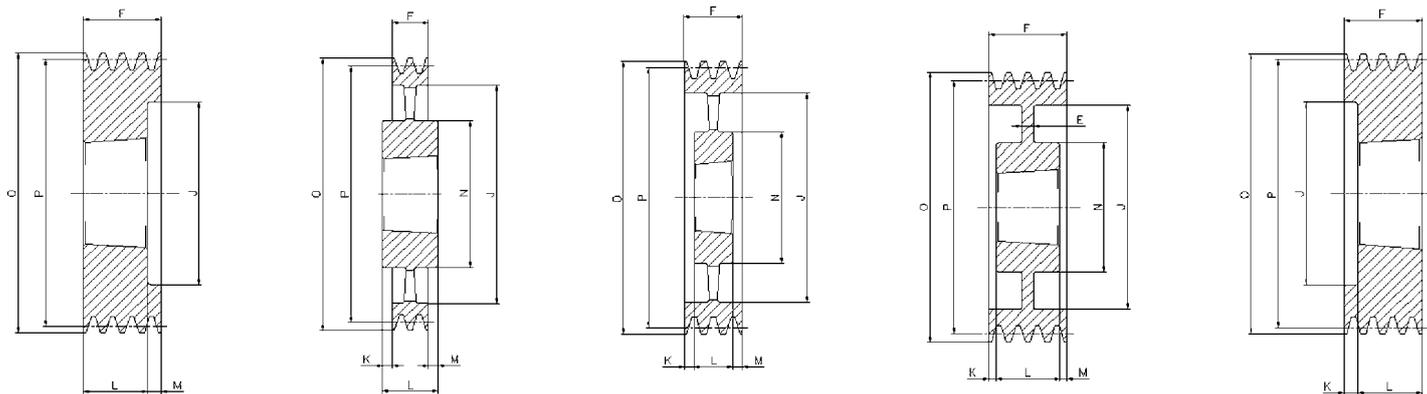

2

4

5

6

8

# SPA/4

Cod. interno Internal code Code interne Código interno	Tipo Type Typ Type Tipo	Gole Grooves Rillen Gorges Canales	P	O	Forma Form Forme Forme Forma	Bussola Buchse Moyeu Casquillo	∅ MAX	E	F	J	K	L	M	N
AT00804	SPA 80-04	4	80	85,5	8	1215	28	-	65	49	27	38	-	-
AT00904	SPA 90-04	4	90	95,5	8	1615	42	-	65	59	27,0	38	-	-
AT00954	SPA 95-04	4	95	100,5	8	1615	42	-	65	63	27,0	38	-	-
AT01004	SPA100-04	4	100	105,5	2	1615	42	-	65	66	-	38	27,0	-
AT01064	SPA106-04	4	106	111,5	8	2012	50	-	65	72	33,0	32	-	-
AT01124	SPA112-04	4	112	117,5	8	2012	50	-	65	78	33,0	32	-	-
AT01184	SPA118-04	4	118	123,5	2	2012	50	-	65	84	-	32	33,0	-
AT01254	SPA125-04	4	125	130,5	2	2012	50	-	65	91	-	32	33,0	-
AT01324	SPA132-04	4	132	137,5	2	2517	60	-	65	98	-	45	20,0	-
AT01404	SPA140-04	4	140	145,5	2	2517	60	-	65	106	-	45	20,0	-
AT01504	SPA150-04	4	150	155,5	2	2517	60	-	65	116	-	45	20,0	-
AT01604	SPA160-04	4	160	165,5	2	2517	60	-	65	125	-	45	20,0	-
AT01704	SPA170-04	4	170	175,5	2	2517	60	-	65	135	-	45	20,0	-
AT01804	SPA180-04	4	180	185,5	2	2517	60	-	65	146	-	45	20,0	-
AT01904	SPA190-04	4	190	195,5	2	2517	60	-	65	156	-	45	20,0	-
AT02004	SPA200-04	4	200	205,5	2	3020	75	-	65	165	-	51	14,0	-
AT02124	SPA212-04	4	212	217,5	2	3020	75	-	65	177	-	51	14,0	-
AT02244	SPA224-04	4	224	229,5	2	3020	75	-	65	189	-	51	14,0	-
AT02364	SPA236-04	4	236	241,5	6	3020	75	25	65	202	-	51	14,0	-
AT02504	SPA250-04	4	250	255,5	6	3020	75	20	65	215	7,0	51	7,0	159
AT02804	SPA280-04	4	280	285,5	6	3020	75	25	65	245	7,0	51	7,0	159
AT03004	SPA300-04	4	300	305,5	6	3020	75	25	65	265	7,0	51	7,0	159
AT03154	SPA315-04	4	315	320,5	6	3020	75	25	65	280	7,0	51	7,0	159
AT03554	SPA355-04	4	355	360,5	5	3020	75	-	65	320	7,0	51	7,0	159
AT04004	SPA400-04	4	400	405,5	5	3020	75	-	65	365	7,0	51	7,0	159
AT04504	SPA450-04	4	450	455,5	5	3020	75	-	65	415	7,0	51	7,0	159
AT05004	SPA500-04	4	500	505,5	5	3020	75	-	65	465	7,0	51	7,0	159
AT05604	SPA560-04	4	560	565,5	4	3535	90	-	65	525	12,0	89	12,0	175
AT06304	SPA630-04	4	630	635,5	4	3535	90	-	65	595	12,0	89	12,0	175
AT08004	SPA800-04	4	800	805,5	4	3535	90	-	65	765	12,0	89	12,0	175
AT10004	SPA1000-04	4	1000	1005,5	4	4040	100	-	65	965	18,5	102	18,5	210

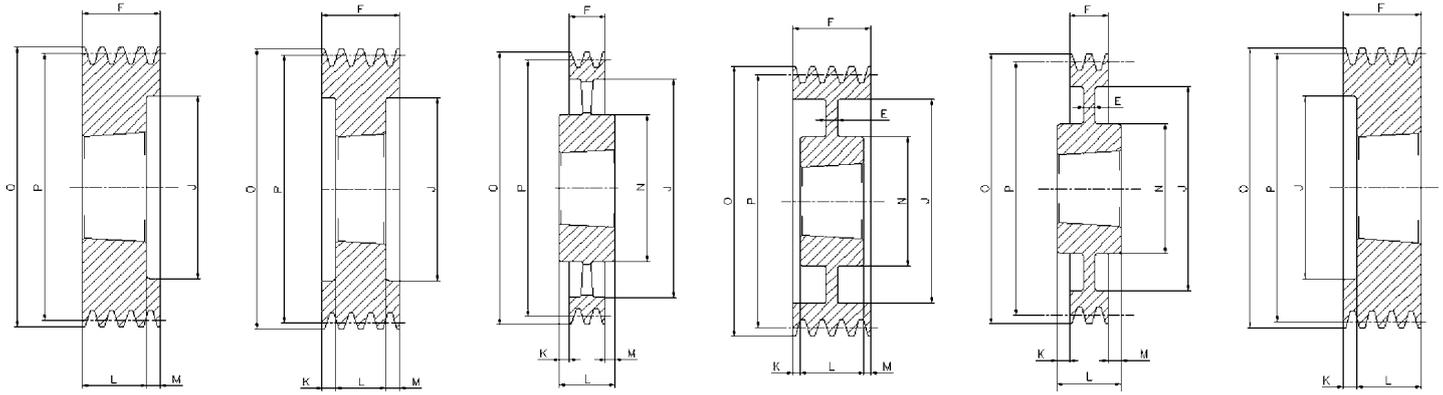

2

3

4

6

7

8

# SPA/5

Cod. interno Internal code Inner Code Code interne Código interno	Tipo Type Typ Type Tipo	Gole Grooves Rillen Gorges Canales	P	O	Forma Form Forme Forme Forma	Bussola Bush Buchse Moyeu Casquillo	∅ MAX	E	F	J	K	L	M	N
AT01005	SPA100-05	5	100	105,5	2	1615	42	-	80	66	-	38	42,0	-
AT01065	SPA106-05	5	106	111,5	8	2012	50	-	80	72	48,0	32	-	-
AT01125	SPA112-05	5	112	117,5	8	2012	50	-	80	78	48,0	32	-	-
AT01185	SPA118-05	5	118	123,5	2	2012	50	-	80	84	-	32	48,0	-
AT01255	SPA125-05	5	125	130,5	3	2012	50	-	80	91	24,0	32	24,0	-
AT01325	SPA132-05	5	132	137,5	3	2517	60	-	80	98	17,5	45	17,5	-
AT01405	SPA140-05	5	140	145,5	3	2517	60	-	80	106	17,5	45	17,5	-
AT01505	SPA150-05	5	150	155,5	3	2517	60	-	80	116	17,5	45	17,5	-
AT01605	SPA160-05	5	160	165,5	3	2517	60	-	80	125	17,5	45	17,5	-
AT01705	SPA170-05	5	170	175,5	3	2517	60	-	80	135	17,5	45	17,5	-
AT01805	SPA180-05	5	180	185,5	3	3020	75	-	80	146	-	51	29,0	-
AT01905	SPA190-05	5	190	195,5	2	3020	75	-	80	156	14,5	51	14,5	-
AT02005	SPA200-05	5	200	205,5	3	3020	75	-	80	165	14,5	51	14,5	-
AT02125	SPA212-05	5	212	217,5	2	3020	75	-	80	177	-	51	29,0	-
AT02245	SPA224-05	5	224	229,5	2	3020	75	-	80	189	-	51	29,0	-
AT02365	SPA236-05	5	236	241,5	2	3020	75	-	80	202	-	51	29,0	-
AT02505	SPA250-05	5	250	255,5	6	3020	75	20	80	215	14,5	51	14,5	159
AT02805	SPA280-05	5	280	285,5	7	3535	90	25	80	245	4,5	89	4,5	175
AT03005	SPA300-05	5	300	305,5	7	3535	90	25	80	265	4,5	89	4,5	175
AT03155	SPA315-05	5	315	320,5	7	3535	90	25	80	280	4,5	89	4,5	175
AT03555	SPA355-05	5	355	360,5	4	3535	90	-	80	320	4,5	89	4,5	175
AT04005	SPA400-05	5	400	405,5	4	3535	90	-	80	365	4,5	89	4,5	175
AT04505	SPA450-05	5	450	455,5	4	3535	90	-	80	415	4,5	89	4,5	175
AT05005	SPA500-05	5	500	505,5	4	3535	90	-	80	465	4,5	89	4,5	175
AT05605	SPA560-05	5	560	565,5	4	3535	90	-	80	525	4,5	89	4,5	175
AT06305	SPA630-05	5	630	635,5	4	3535	90	-	80	595	4,5	89	4,5	175
AT08005	SPA800-05	5	800	805,5	4	4040	100	-	80	765	11,0	102	11,0	210
AT10005	SPA1000-05	5	1000	1005,5	4	4545	110	-	80	965	17,0	114	17,0	242

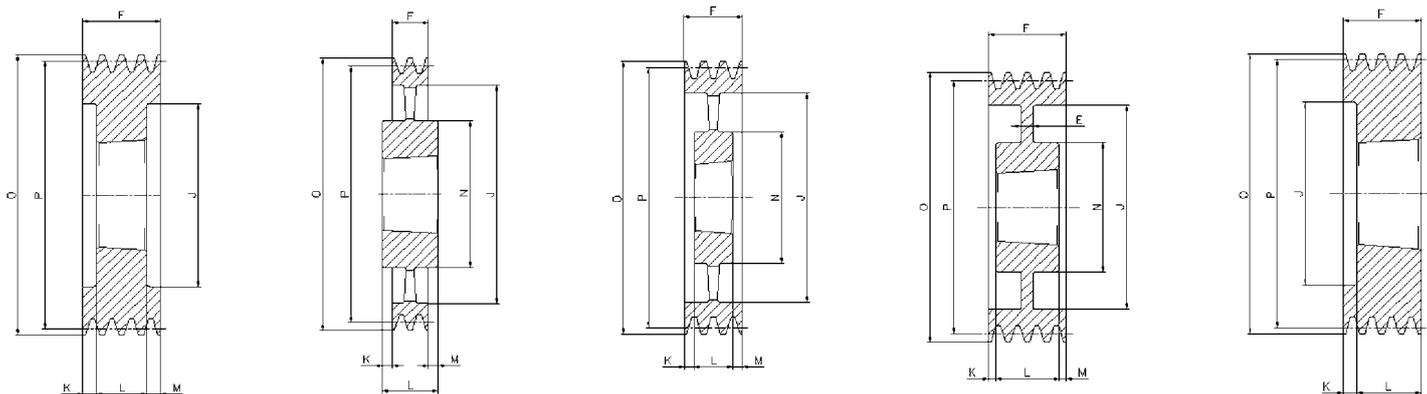

3

4

5

6

8

# SPA/6

Cod. interno Internal code Inner Code Code interne Código interno	Tipo Type Typ Type Tipo	Gole Grooves Rillen Gorges Canales	P	O	Forma Form Forme Forme Forma	Bussola Bush Buchse Moyeu Casquillo	∅ MAX	E	F	J	K	L	M	N
AT01006	SPA100-06	6	100	105,5	3	1610	42	-	95	66	30,0	25	40,0	-
AT01066	SPA106-06	6	106	111,5	8	2012	50	-	95	72	63,0	32	-	-
AT01126	SPA112-06	6	112	117,5	8	2012	50	-	95	78	63,0	32	-	-
AT01186	SPA118-06	6	118	123,5	8	2012	50	-	95	84	63,0	32	-	-
AT01256	SPA125-06	6	125	130,5	3	2012	50	-	95	91	31,5	32	31,5	-
AT01326	SPA132-06	6	132	137,5	3	2517	60	-	95	98	25,0	45	25,0	-
AT01406	SPA140-06	6	140	145,5	3	2517	60	-	95	106	25,0	45	25,0	-
AT01506	SPA150-06	6	150	155,5	3	2517	60	-	95	116	25,0	45	25,0	-
AT01606	SPA160-06	6	160	165,5	3	2517	60	-	95	125	25,0	45	25,0	-
AT01806	SPA180-06	6	180	185,5	3	3020	75	-	95	146	22,0	51	22,0	-
AT02006	SPA200-06	6	200	205,5	3	3020	75	-	95	165	22,0	51	22,0	-
AT02126	SPA212-06	6	212	217,5	3	3020	75	-	95	176	22,0	51	22,0	-
AT02246	SPA224-06	6	224	229,5	3	3020	75	-	95	189	22,0	51	22,0	-
AT02366	SPA236-06	6	236	241,5	3	3020	75	-	95	202	22,0	51	22,0	-
AT02506	SPA250-06	6	250	255,5	6	3020	75	20	95	215	22,0	51	22,0	155
AT02806	SPA280-06	6	280	285,5	6	3535	90	25	95	245	3,0	89	3,0	175
AT03006	SPA300-06	6	300	305,5	6	3535	90	25	95	265	3,0	89	3,0	175
AT03156	SPA315-06	6	315	320,5	6	3535	90	25	95	280	3,0	89	3,0	175
AT03556	SPA355-06	6	355	360,5	5	3535	90	-	95	320	3,0	89	3,0	175
AT04006	SPA400-06	6	400	405,5	5	3535	90	-	95	365	3,0	89	3,0	175
AT04506	SPA450-06	6	450	455,5	5	3535	90	-	95	415	3,0	89	3,0	175
AT05006	SPA500-06	6	500	505,5	5	3535	90	-	95	465	3,0	89	3,0	175
AT05606	SPA560-06	6	560	565,5	5	3535	90	-	95	525	3,0	89	3,0	175
AT06306	SPA630-06	6	630	635,5	4	4040	100	-	95	595	3,5	102	3,5	210
AT08006	SPA800-06	6	800	805,5	4	4040	100	-	95	765	3,5	102	3,5	210
AT10006	SPA1000-06	6	1000	1005,5	4	4545	110	-	95	965	9,5	114	9,5	242

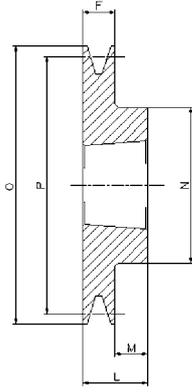
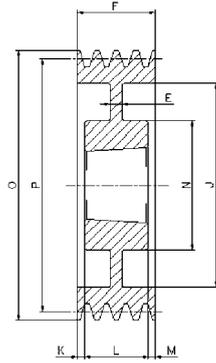
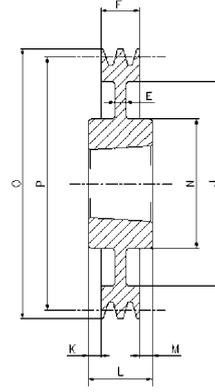
**1**

**6**

**7**

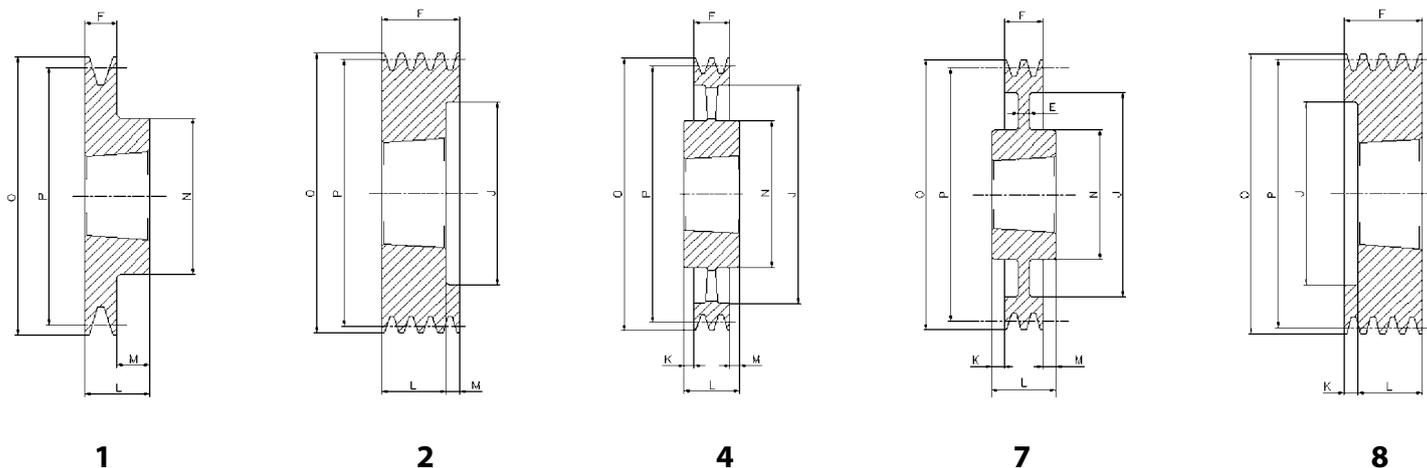
# SPB/1

Cod. interno Internal code Innerer Code Code interne Código interno	Tipo Type Typ Type Tipo	Gole Grooves Rillen Gorges Canales	P	O	Forma Form Forme Forme Forma	Bussola Bush Buchse Moyeu Casquillo	Ø MAX	E	F	J	K	L	M	N
BT01001	SPB100-01	1	<b>100</b>	107	1	1610	42	-	25	-	-	25	-	-
BT01061	SPB106-1	1	<b>106</b>	113	1	1610	42	-	25	-	-	25	-	-
BT01121	SPB112-01	1	<b>112</b>	119	1	1610	42	-	25	-	-	25	-	-
BT01181	SPB118-01	1	<b>118</b>	125	1	1610	42	-	25	-	-	25	-	-
BT01251	SPB125-01	1	<b>125</b>	132	1	1610	42	-	25	-	-	25	-	-
BT01321	SPB132-01	1	<b>132</b>	139	1	1610	42	-	25	-	-	25	-	-
BT01401	SPB140-01	1	<b>140</b>	147	1	1610	42	-	25	-	-	25	-	-
BT01501	SPB150-01	1	<b>150</b>	157	1	1610	42	-	25	-	-	25	-	-
BT01601	SPB160-01	1	<b>160</b>	167	1	1610	42	-	25	-	-	25	-	-
BT01701	SPB170-01	1	<b>170</b>	177	1	1610	42	-	25	-	-	25	-	-
BT01801	SPB180-01	1	<b>180</b>	187	6	1610	42	15	25	132	-	25	-	90
BT01901	SPB190-01	1	<b>190</b>	197	7	2012	50	15	25	147	3,5	32	3,5	104
BT02001	SPB200-01	1	<b>200</b>	207	7	2012	50	15	25	157	3,5	32	3,5	104
BT02121	SPB212-01	1	<b>212</b>	219	7	2012	50	15	25	169	3,5	32	3,5	104
BT02241	SPB224-01	1	<b>224</b>	231	7	2012	50	15	25	181	3,5	32	3,5	104
BT02361	SPB236-01	1	<b>236</b>	243	7	2012	50	15	25	193	3,5	32	3,5	104
BT02501	SPB250-01	1	<b>250</b>	257	7	2012	50	20	25	207	3,5	32	3,5	104
BT02801	SPB280-01	1	<b>280</b>	287	7	2012	50	20	25	237	3,5	32	3,5	104
BT03001	SPB300-01	1	<b>300</b>	307	7	2012	50	20	25	258	3,5	32	3,5	104
BT03151	SPB315-01	1	<b>315</b>	322	7	2012	50	20	25	272	3,5	32	3,5	104



# SPB/2

Cod. interno Internal code Innerer Code Code interne Código interno	Tipo Type Typ Type Tipo	Gole Grooves Rillen Gorges Canales	P	O	Forma Form Forme Forme Forma	Bussola Bush Buchse Moyeu Casquillo	Ø MAX	E	F	J	K	L	M	N
BT01002	SPB100-02	2	<b>100</b>	107	8	1610	42	-	44	62	19,0	25	-	-
BT01062	SPB106-02	2	<b>106</b>	113	8	1610	42	-	44	67	19,0	25	-	-
BT01122	SPB112-02	2	<b>112</b>	119	8	1610	42	-	44	72	19,0	25	-	-
BT01182	SPB118-02	2	<b>118</b>	125	2	1610	42	-	44	78	-	25	19,0	-
BT01252	SPB125-02	2	<b>125</b>	132	2	2012	50	-	44	82	-	32	12,0	-
BT01322	SPB132-02	2	<b>132</b>	139	2	2012	50	-	44	89	-	32	12,0	-
BT01402	SPB140-02	2	<b>140</b>	147	2	2012	50	-	44	97	-	32	12,0	-
BT01502	SPB150-02	2	<b>150</b>	157	2	2012	50	-	44	107	-	32	12,0	-
BT01602	SPB160-02	2	<b>160</b>	167	2	2012	50	-	44	117	-	32	12,0	-
BT01702	SPB170-02	2	<b>170</b>	177	2	2012	50	-	44	127	-	32	12,0	-
BT01802	SPB180-02	2	<b>180</b>	187	1	2517	60	-	44	-	-	45	1,0	120
BT01902	SPB190-02	2	<b>190</b>	197	1	2517	60	-	44	-	-	45	1,0	120
BT02002	SPB200-02	2	<b>200</b>	207	1	2517	60	-	44	-	-	45	1,0	117
BT02122	SPB212-02	2	<b>212</b>	219	7	2517	60	20	44	169	-	45	1,0	117
BT02242	SPB224-02	2	<b>224</b>	231	7	2517	60	15	44	181	-	45	1,0	117
BT02362	SPB236-02	2	<b>236</b>	243	7	2517	60	15	44	193	-	45	1,0	117
BT02502	SPB250-02	2	<b>250</b>	257	7	2517	60	20	44	207	-	45	1,0	125
BT02802	SPB280-02	2	<b>280</b>	287	7	2517	60	20	44	237	-	45	1,0	125
BT03002	SPB300-02	2	<b>300</b>	307	7	2517	60	20	44	257	-	45	1,0	125
BT03152	SPB315-02	2	<b>315</b>	322	7	2517	60	20	44	272	-	45	1,0	125
BT03352	SPB335-02	2	<b>335</b>	342	7	2517	60	20	44	292	-	45	1,0	125
BT03552	SPB355-02	2	<b>355</b>	362	7	3020	75	15	44	312	3,5	51	3,5	144
BT04002	SPB400-02	2	<b>400</b>	407	4	3020	75	-	44	357	3,5	51	3,5	150
BT04502	SPB450-02	2	<b>450</b>	457	4	3020	75	-	44	407	3,5	51	3,5	150
BT05002	SPB500-02	2	<b>500</b>	507	4	3020	75	-	44	457	3,5	51	3,5	150
BT05602	SPB560-02	2	<b>560</b>	567	4	3030	75	-	44	517	4,0	76	28,0	150
BT06302	SPB630-02	2	<b>630</b>	637	4	3030	75	-	44	587	16,0	76	16,0	150

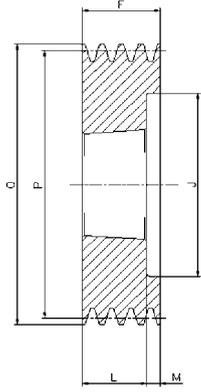

2

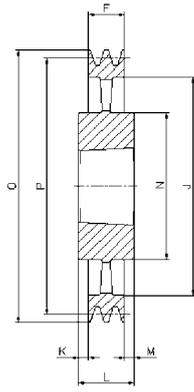

4

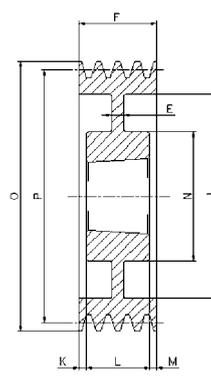

6

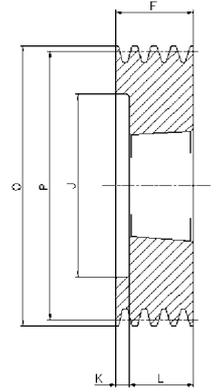

8

# SPB/3

Cod. interno Internal code Innerer Code Code interne Código interno	Tipo Type Typ Type Tipo	Gole Grooves Rillen Gorges Canales	P	O	Forma Form Forme Forme Forma	Bussola Bush Buchse Moyeu Casquillo	∅ MAX	E	F	J	K	L	M	N
BT01003	SPB100-03	3	100	107	8	1610	42	-	63	62	38,0	25	-	-
BT01063	SPB106-03	3	106	113	8	1610	42	-	63	67	38,0	25	-	-
BT01123	SPB112-03	3	112	119	8	1610	42	-	63	72	38,0	25	-	-
BT01183	SPB118-03	3	118	125	2	1610	42	-	63	78	-	25	38,0	-
BT01253	SPB125-03	3	125	132	2	2012	50	-	63	82	-	32	31,0	-
BT01323	SPB132-03	3	132	139	2	2012	50	-	63	89	-	32	31,0	-
BT01403	SPB140-03	3	140	147	2	2012	50	-	63	97	-	32	31,0	-
BT01503	SPB150-03	3	150	157	2	2517	60	-	63	107	-	45	18,0	-
BT01603	SPB160-03	3	160	167	2	2517	60	-	63	117	-	45	18,0	-
BT01703	SPB170-03	3	170	177	2	2517	60	-	63	127	-	45	18,0	-
BT01803	SPB180-03	3	180	187	2	2517	60	-	63	137	-	45	18,0	-
BT01903	SPB190-03	3	190	197	2	2517	60	-	63	147	-	45	18,0	-
BT02003	SPB200-03	3	200	207	2	2517	60	-	63	157	-	45	18,0	-
BT02123	SPB212-03	3	212	219	6	2517	60	15	63	169	-	45	18,0	117
BT02243	SPB224-03	3	224	231	6	2517	60	15	63	181	-	45	18,0	117
BT02363	SPB236-03	3	236	243	6	2517	60	15	63	193	-	45	18,0	117
BT02503	SPB250-03	3	250	257	6	3020	75	20	63	207	-	51	12,0	144
BT02803	SPB280-03	3	280	287	6	3020	75	20	63	237	6,0	51	6,0	144
BT03003	SPB300-03	3	300	307	6	3020	75	20	63	257	6,0	51	6,0	144
BT03153	SPB315-03	3	315	322	6	3020	75	20	63	272	6,0	51	6,0	144
BT03353	SPB335-03	3	335	342	6	3020	75	20	63	292	6,0	51	6,0	144
BT03553	SPB355-03	3	355	362	6	3020	75	15	63	312	6,0	51	6,0	144
BT04003	SPB400-03	3	400	407	4	3535	90	-	63	357	13,0	89	13,0	175
BT04503	SPB450-03	3	450	457	4	3535	90	-	63	407	-	89	26,0	175
BT05003	SPB500-03	3	500	507	4	3535	90	-	63	457	-	89	26,0	175
BT05603	SPB560-03	3	560	567	4	3535	90	-	63	517	-	89	26,0	175
BT06303	SPB630-03	3	630	637	4	3535	90	-	63	587	-	89	26,0	175
BT07103	SPB710-03	3	710	717	4	3535	90	-	63	664	13,0	89	13,0	175
BT08003	SPB800-03	3	800	807	4	3535	90	-	63	754	13,0	89	13,0	175
BT09003	SPB900-03	3	900	907	4	3535	90	-	63	854	13,0	89	13,0	175
BT10003	SPB1000-03	3	1000	1007	4	4040	100	-	63	954	19,5	102	19,5	210
BT12503	SPB1250-03	3	1250	1257	4	4040	100	-	63	1204	19,5	102	19,5	210

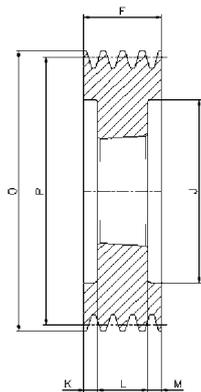

3

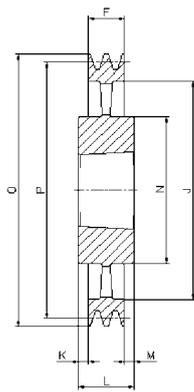

4

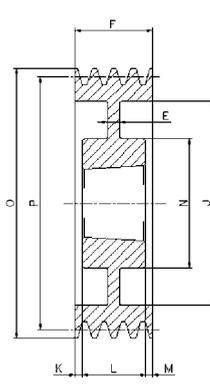

6

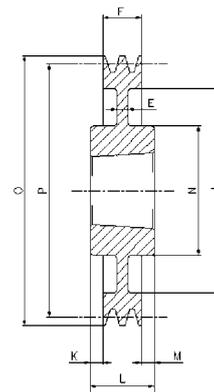

7

# SPB/4

Cod. interno Internal code Innerer Code Code interne Código interno	Tipo Type Typ Type Tipo	Gole Grooves Rillen Gorges Canales	P	O	Forma Form Forme Forme Forma	Bussola Bush Buchse Moyeu Casquillo	Ø MAX	E	F	J	K	L	M	N
BT01124	SPB112-04	4	112	119	8	1610	42	-	82	72	57,0	25	-	-
BT01254	SPB125-04	4	125	132	3	2012	50	-	82	82	25,0	32	25,0	-
BT01324	SPB132-04	4	132	139	3	2012	50	-	82	89	25,0	32	25,0	-
BT01404	SPB140-04	4	140	147	3	2517	60	-	82	100	18,5	45	18,5	-
BT01504	SPB150-04	4	150	157	3	2517	60	-	82	107	18,5	45	18,5	-
BT01604	SPB160-04	4	160	167	3	2517	60	-	82	117	18,5	45	18,5	-
BT01704	SPB170-04	4	170	177	3	2517	60	-	82	127	18,5	45	18,5	-
BT01804	SPB180-04	4	180	187	3	2517	60	-	82	137	18,5	45	18,5	-
BT01904	SPB190-04	4	190	197	3	2517	60	-	82	147	18,5	45	18,5	-
BT02004	SPB200-04	4	200	207	3	3020	75	-	82	157	15,5	51	15,5	-
BT02124	SPB212-04	4	212	219	3	3020	75	-	82	169	15,5	51	15,5	-
BT02244	SPB224-04	4	224	231	3	3020	75	-	82	181	15,5	51	15,5	-
BT02364	SPB236-04	4	236	243	3	3020	75	-	82	193	15,5	51	15,5	-
BT02504	SPB250-04	4	250	257	6	3020	75	25	82	207	15,5	51	15,5	144
BT02804	SPB280-04	4	280	287	6	3020	75	25	82	237	15,5	51	15,5	144
BT03004	SPB300-04	4	300	307	7	3535	90	25	82	257	-	89	7,0	175
BT03154	SPB315-04	4	315	322	7	3535	90	25	82	272	3,5	89	3,5	175
BT03354	SPB335-04	4	335	342	7	3535	90	25	82	292	3,5	89	3,5	175
BT03554	SPB355-04	4	355	362	7	3535	90	25	82	312	3,5	89	3,5	175
BT04004	SPB400-04	4	400	407	4	3535	90	-	82	357	3,5	89	3,5	175
BT04504	SPB450-04	4	450	457	4	3535	90	-	82	407	-	89	7,0	175
BT05004	SPB500-04	4	500	507	4	3535	90	-	82	457	-	89	7,0	175
BT05604	SPB560-04	4	560	567	4	3535	90	-	82	517	-	89	7,0	175
BT06304	SPB630-04	4	630	637	4	3535	90	-	82	587	-	89	7,0	175
BT07104	SPB710-04	4	710	717	4	3535	90	-	82	664	3,5	89	3,5	175
BT08004	SPB800-04	4	800	807	4	4040	100	-	82	754	10,0	102	10,0	210
BT09004	SPB900-04	4	900	907	4	4040	100	-	82	854	10,0	102	10,0	210
BT10004	SPB1000-04	4	1000	1007	4	4040	100	-	82	954	10,0	102	16,0	210
BT12504	SPB1250-04	4	1250	1257	4	4545	110	-	82	1204	16,0	114	16,0	210

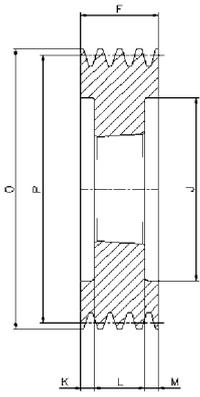

3

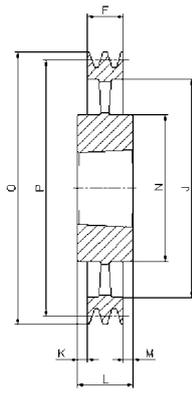

4

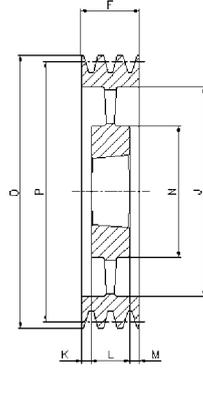

5

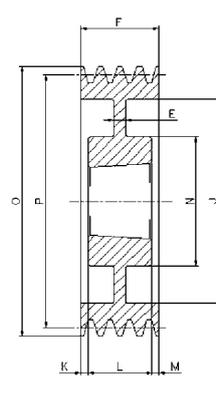

6

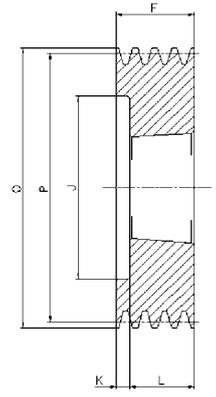

8

# SPB/5

Cod. interno Internal code Code interne Código interno	Tipo Type Typ Type Tipo	Gole Grooves Rillen Gorges Canales	P	O	Forma Form Forme Forme Forma	Bussola Bush Buchse Moyeu Casquillo	∅ MAX	E	F	J	K	L	M	N
BT01255	SPB125-05	5	125	132	8	2012	50	-	101	87	69,0	32	-	-
BT01325	SPB132-05	5	132	139	8	2517	60	-	101	94	56,0	45	-	-
BT01405	SPB140-05	5	140	147	3	2517	60	-	101	97	28,0	45	28,0	-
BT01505	SPB150-05	5	150	157	3	2517	60	-	101	107	28,0	45	28,0	-
BT01605	SPB160-05	5	160	167	3	2517	60	-	101	117	28,0	45	28,0	-
BT01705	SPB170-05	5	170	177	3	3020	75	-	101	127	25,0	51	25,0	-
BT01805	SPB180-05	5	180	187	3	3020	75	-	101	137	25,0	51	25,0	-
BT01905	SPB190-05	5	190	197	3	3020	75	-	101	147	25,0	51	25,0	-
BT02005	SPB200-05	5	200	207	3	3020	75	-	101	157	25,0	51	25,0	-
BT02125	SPB212-05	5	212	219	3	3020	75	-	101	169	25,0	51	25,0	-
BT02245	SPB224-05	5	224	231	3	3020	75	-	101	181	25,0	51	25,0	-
BT02365	SPB236-05	5	236	243	3	3535	90	-	101	193	6,0	89	6,0	-
BT02505	SPB250-05	5	250	257	3	3535	90	-	101	207	6,0	89	6,0	-
BT02805	SPB280-05	5	280	287	6	3535	90	25	101	237	6,0	89	6,0	175
BT03005	SPB300-05	5	300	307	6	3535	90	25	101	257	6,0	89	6,0	175
BT03155	SPB315-05	5	315	322	6	3535	90	25	101	272	6,0	89	6,0	175
BT03355	SPB335-05	5	335	342	6	3535	90	25	101	292	6,0	89	6,0	175
BT03555	SPB355-05	5	355	362	6	3535	90	17	101	312	6,0	89	6,0	175
BT04005	SPB400-05	5	400	407	5	3535	90	-	101	357	6,0	89	6,0	175
BT04505	SPB450-05	5	450	457	5	3535	90	-	101	407	-	89	12,0	175
BT05005	SPB500-05	5	500	507	5	3535	90	-	101	457	-	89	12,0	175
BT05605	SPB560-05	5	560	567	4	4040	100	-	101	517	-	102	1,0	210
BT06305	SPB630-05	5	630	637	4	4040	100	-	101	587	-	102	1,0	210
BT07105	SPB710-05	5	710	717	4	4040	100	-	101	664	-	102	1,0	210
BT08005	SPB800-05	5	800	807	4	4040	100	-	101	754	-	102	1,0	210
BT09005	SPB900-05	5	900	907	4	4040	100	-	101	854	-	102	1,0	210
BT10005	SPB1000-05	5	1000	1007	4	4545	110	-	101	954	6,5	114	6,5	242
BT12505	SPB1250-05	5	1250	1257	4	4545	110	-	101	1204	6,5	114	6,5	242



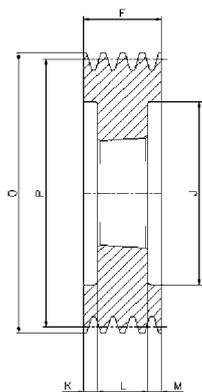

3

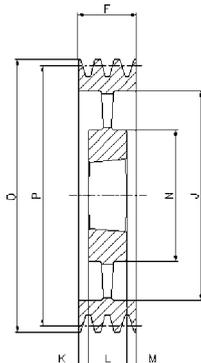

5

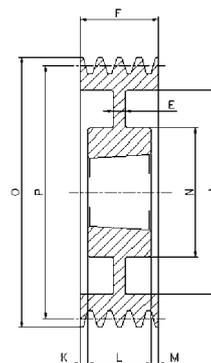

6

# SPB/6

Cod. interno Internal code Inner Code Code interne Código interno	Tipo Type Typ Type Tipo	Gole Grooves Rillen Gorges Canales	P	O	Forma Forme Forme Forme Forma	Bussola Bush Buchse Moyeu Casquillo	∅ MAX	E	F	J	K	L	M	N
BT01406	SPB140-06	6	140	147	3	2517	60	-	120	100	37,5	45	37,5	-
BT01506	SPB150-06	6	150	157	3	2517	60	-	120	107	37,5	45	37,5	-
BT01606	SPB160-06	6	160	167	3	3020	75	-	120	117	34,5	51	34,5	-
BT01706	SPB170-06	6	170	177	3	3020	75	-	120	127	34,5	51	34,5	-
BT01806	SPB180-06	6	180	187	3	3020	75	-	120	137	34,5	51	34,5	-
BT01906	SPB190-06	6	190	197	3	3020	75	-	120	147	34,5	51	34,5	-
BT02006	SPB200-06	6	200	207	3	3020	75	-	120	157	34,5	51	34,5	-
BT02126	SPB212-06	6	212	219	3	3535	90	-	120	169	15,5	89	15,5	-
BT02246	SPB224-06	6	224	231	3	3535	90	-	120	181	15,5	89	15,5	-
BT02366	SPB236-06	6	236	243	3	3535	90	-	120	193	15,5	89	15,5	-
BT02506	SPB250-06	6	250	257	3	3535	90	-	120	207	15,5	89	15,5	-
BT02806	SPB280-06	6	280	287	6	3535	90	25	120	237	15,5	89	15,5	175
BT03006	SPB300-06	6	300	307	6	3535	90	25	120	257	15,5	89	15,5	175
BT03156	SPB315-06	6	315	322	6	3535	90	25	120	272	15,5	89	15,5	175
BT03356	SPB335-06	6	335	342	6	3535	90	25	120	292	15,5	89	15,5	175
BT03556	SPB355-06	6	355	362	6	3535	90	25	120	312	15,5	89	15,5	175
BT04006	SPB400-06	6	400	407	5	3535	90	-	120	357	15,5	89	15,5	175
BT04506	SPB450-06	6	450	457	5	4040	100	-	120	407	-	102	18,0	210
BT05006	SPB500-06	6	500	507	5	4040	100	-	120	457	-	102	18,0	210
BT05606	SPB560-06	6	560	567	5	4040	100	-	120	517	-	102	18,0	210
BT06306	SPB630-06	6	630	637	5	4040	100	-	120	587	-	102	18,0	210
BT07106	SPB710-06	6	710	717	5	4040	100	-	120	664	9,0	102	9,0	210
BT08006	SPB800-06	6	800	807	5	4545	110	-	120	754	3,0	114	3,0	242
BT09006	SPB900-06	6	900	907	5	4545	110	-	120	854	3,0	114	3,0	242
BT10006	SPB1000-06	6	1000	1007	5	4545	110	-	120	954	3,0	114	3,0	242
BT12506	SPB1250-06	6	1250	1257	5	4545	110	-	120	1204	3,0	114	3,0	242

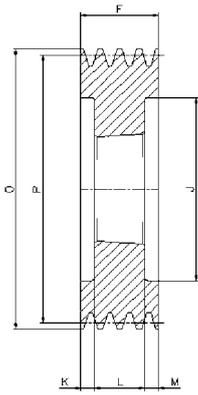

3

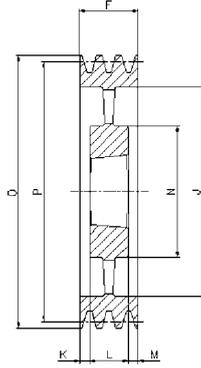

5

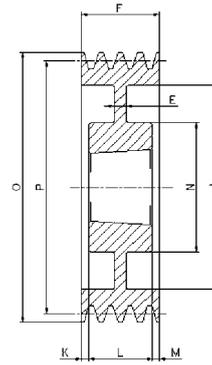

6

# SPB/8

Cod. interno Internal code Innerer Code Code interne Código interno	Tipo Type Typ Type Tipo	Gole Grooves Rillen Gorges Canales	P	O	Forma Form Forme Forme Forma	Bussola Bush Buchse Moyeu Casquillo	Ø MAX	E	F	J	K	L	M	N
BT01408	SPB140-08	8	140	147	3	2517	60	-	158	97	56,5	45	56,5	-
BT01608	SPB160-08	8	160	167	3	3020	75	-	158	117	53,5	51	53,5	-
BT01708	SPB170-08	8	170	177	3	3030	75	-	158	127	41,0	76	41,0	-
BT01808	SPB180-08	8	180	187	3	3030	75	-	158	137	41,0	76	41,0	-
BT01908	SPB190-08	8	190	197	3	3030	75	-	158	147	41,0	76	41,0	-
BT02008	SPB200-08	8	200	207	3	3535	90	-	158	157	34,5	89	34,5	-
BT02128	SPB212-08	8	212	219	3	3535	90	-	158	169	34,5	89	34,5	-
BT02248	SPB224-08	8	224	231	3	3535	90	-	158	181	34,5	89	34,5	-
BT02368	SPB236-08	8	236	243	3	3535	90	-	158	193	34,5	89	34,5	-
BT02508	SPB250-08	8	250	257	3	3535	90	-	158	207	34,5	89	34,5	-
BT02808	SPB280-08	8	280	287	6	3535	90	25	158	237	34,5	89	34,5	175
BT03008	SPB300-08	8	300	307	6	3535	90	25	158	257	34,5	89	34,5	175
BT03158	SPB315-08	8	315	322	6	3535	90	25	158	272	34,5	89	34,5	175
BT03358	SPB335-08	8	335	342	6	3535	90	25	158	292	34,5	89	34,5	175
BT03558	SPB355-08	8	355	362	6	3535	90	25	158	312	34,5	89	34,5	175
BT04008	SPB400-08	8	400	407	6	4040	100	30	158	357	28,0	102	28,0	210
BT04508	SPB450-08	8	450	457	5	4040	100	-	158	407	28,0	102	28,0	210
BT05008	SPB500-08	8	500	507	5	4040	100	-	158	457	28,0	102	28,0	210
BT05608	SPB560-08	8	560	567	5	4545	110	-	158	517	22,0	114	22,0	242
BT06308	SPB630-08	8	630	637	5	4545	110	-	158	587	22,0	114	22,0	242
BT07108	SPB710-08	8	710	717	5	4545	110	-	158	664	22,0	114	22,0	242
BT08008	SPB800-08	8	800	807	5	4545	110	-	158	754	22,0	114	22,0	242
BT09008	SPB900-08	8	900	907	5	4545	110	-	158	854	22,0	114	22,0	242
BT10008	SPB1000-08	8	1000	1007	5	5050	125	-	158	954	15,5	127	15,5	267
BT12508	SPB1250-08	8	1250	1257	5	5050	125	-	158	1204	15,5	127	15,5	267

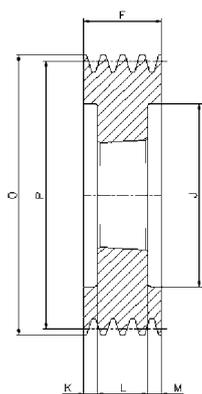

3

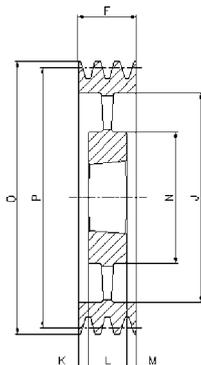

5

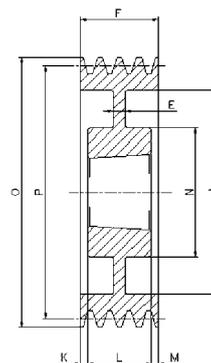

6

# SPB/10

Cod. interno Internal code Innerer Code Code interne Código interno	Tipo Type Typ Type Tipo	Gole Grooves Rillen Gorges Canales	P	O	Forma Form Forme Forme Forma	Bussola Bush Buchse Moyeu Casquillo	∅ MAX	E	F	J	K	L	M	N
BT0224X	SPB224-10	10	<b>224</b>	231	3	3535	90	-	196	181	53,5	89	53,5	-
BT0236X	SPB236-10	10	<b>236</b>	243	3	3535	90	-	196	193	53,5	89	53,5	-
BT0250X	SPB250-10	10	<b>250</b>	257	3	3535	90	-	196	207	53,5	89	53,5	-
BT0280X	SPB280-10	10	<b>280</b>	287	6	3535	90	30	196	237	53,5	89	53,5	175
BT0315X	SPB315-10	10	<b>315</b>	322	6	3535	90	30	196	272	53,5	89	53,5	175
BT0335X	SPB335-10	10	<b>335</b>	342	6	4040	100	30	196	292	47,0	102	47,0	210
BT0355X	SPB355-10	10	<b>355</b>	362	6	4040	100	30	196	312	47,0	102	47,0	210
BT0400X	SPB400-10	10	<b>400</b>	407	6	4040	100	30	196	357	47,0	102	47,0	210
BT0450X	SPB450-10	10	<b>450</b>	457	5	4545	110	-	196	407	41,0	114	41,0	242
BT0500X	SPB500-10	10	<b>500</b>	507	5	4545	110	-	196	457	41,0	114	41,0	242
BT0560X	SPB560-10	10	<b>560</b>	567	5	4545	110	-	196	517	41,0	114	41,0	242
BT0630X	SPB630-10	10	<b>630</b>	637	5	4545	110	-	196	587	41,0	114	41,0	242
BT0710X	SPB710-10	10	<b>710</b>	717	5	4545	110	-	196	664	41,0	114	41,0	242
BT0800X	SPB800-10	10	<b>800</b>	807	5	4545	110	-	196	754	41,0	114	41,0	242
BT0900X	SPB900-10	10	<b>900</b>	907	5	5050	125	-	196	854	34,5	127	34,5	267
BT1000X	SPB1000-10	10	<b>1000</b>	1007	5	5050	125	-	196	954	34,5	127	34,5	267

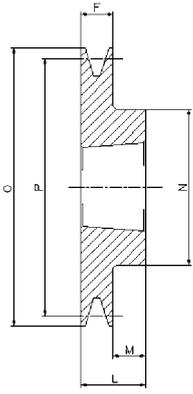
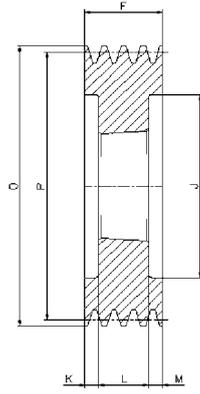
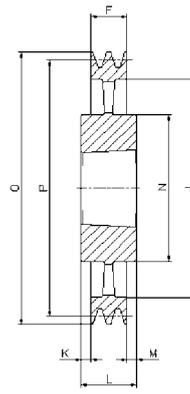
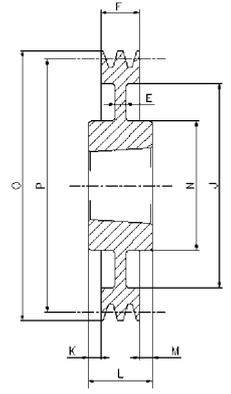

**1**

**3**

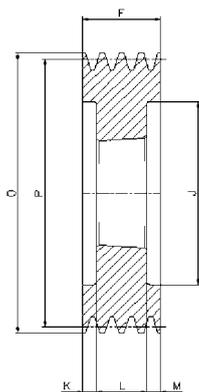
**4**

**7**

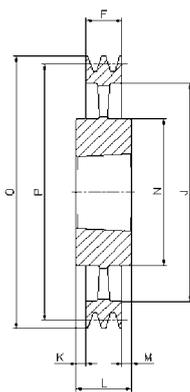
# SPC/3

Cod. interno Internal code Innerer Code Code interne Código interno	Tipo Type Typ Type Tipo	Gole Grooves Rillen Gorges Canales	P	O	Forma Form Forme Forme Forma	Bussola Bush Buchse Moyeu Casquillo	∅ MAX	E	F	J	K	L	M	N
CT02003	SPC200-03	3	<b>200</b>	209,6	3	2517	60	-	85	144	20,0	45	20,0	-
CT02123	SPC212-03	3	<b>212</b>	221,6	3	3020	75	-	85	156	17,0	51	17,0	-
CT02243	SPC224-03	3	<b>224</b>	233,6	3	3020	75	-	85	168	17,0	51	17,0	-
CT02363	SPC236-03	3	<b>236</b>	245,6	3	3020	75	-	85	180	17,0	51	17,0	-
CT02503	SPC250-03	3	<b>250</b>	259,6	3	3020	75	-	85	194	17,0	51	17,0	-
CT02653	SPC265-03	3	<b>265</b>	274,6	1	3535	90	-	85	209	-	89	4,0	175
CT02803	SPC280-03	3	<b>280</b>	289,6	1	3535	90	-	85	224	-	89	4,0	175
CT03003	SPC300-03	3	<b>300</b>	309,6	7	3535	90	20	85	244	2,0	89	2,0	175
CT03153	SPC315-03	3	<b>315</b>	324,6	7	3535	90	20	85	259	2,0	89	2,0	175
CT03353	SPC335-03	3	<b>335</b>	344,6	7	3535	90	20	85	279	2,0	89	2,0	175
CT03553	SPC355-03	3	<b>355</b>	364,6	7	3535	90	20	85	299	2,0	89	2,0	175
CT03753	SPC375-03	3	<b>375</b>	384,6	7	3535	90	25	85	319	2,0	89	2,0	175
CT04003	SPC400-03	3	<b>400</b>	409,6	7	3535	90	17	85	344	2,0	89	2,0	175
CT04253	SPC425-03	3	<b>425</b>	434,6	7	3535	90	17	85	369	2,0	89	2,0	175
CT04503	SPC450-03	3	<b>450</b>	459,6	4	3535	90	-	85	394	2,0	89	2,0	175
CT04753	SPC475-03	3	<b>475</b>	484,6	4	3535	90	-	85	419	2,0	89	2,0	175
CT05003	SPC500-03	3	<b>500</b>	509,6	4	3535	90	-	85	444	2,0	89	2,0	175
CT05303	SPC530-03	3	<b>530</b>	539,6	4	3535	90	-	85	474	2,0	89	2,0	175
CT05603	SPC560-03	3	<b>560</b>	569,6	4	3535	90	-	85	504	2,0	89	2,0	175
CT06303	SPC630-03	3	<b>630</b>	639,6	4	4040	100	-	85	574	8,5	102	8,5	210
CT08003	SPC800-03	3	<b>800</b>	809,6	4	4545	110	-	85	737	14,5	114	14,5	242
CT10003	SPC1000-03	3	<b>1000</b>	1009,6	4	5050	125	-	85	937	21,0	127	21,0	267
CT12503	SPC1250-03	3	<b>1250</b>	1259,6	4	5050	125	-	85	1187	21,0	127	21,0	267



3



4

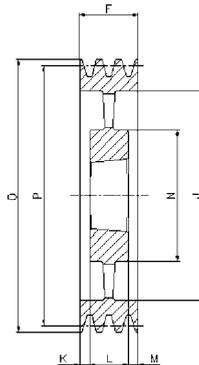

5

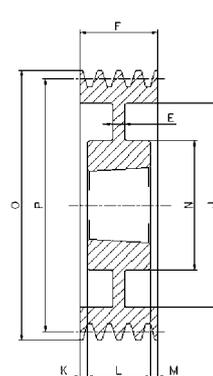

6

# SPC/4

Cod. interno Internal code Innerer Code Code interne Código interno	Tipo Type Typ Type Tipo	Gole Grooves Rillen Gorges Canales	P	O	Forma Form Forme Forme Forma	Bussola Bush Buchse Moyeu Casquillo	∅ MAX	E	F	J	K	L	M	N
CT02004	SPC200-04	4	200	209,6	3	3020	75	-	111	144	30,0	51	30,0	-
CT02124	SPC212-04	4	212	221,6	3	3020	75	-	111	156	30,0	51	30,0	-
CT02244	SPC224-04	4	224	233,6	3	3535	90	-	111	168	11,0	89	11,0	-
CT02364	SPC236-04	4	236	245,6	3	3535	90	-	111	180	11,0	89	11,0	-
CT02504	SPC250-04	4	250	259,6	3	3535	90	-	111	194	11,0	89	11,0	-
CT02654	SPC265-04	4	265	274,6	3	3535	90	-	111	209	11,0	89	11,0	-
CT02804	SPC280-04	4	280	289,6	6	3535	90	18	111	224	11,0	89	11,0	175
CT03004	SPC300-04	4	300	309,6	6	3535	90	20	111	244	11,0	89	11,0	175
CT03154	SPC315-04	4	315	324,6	6	3535	90	20	111	259	11,0	89	11,0	175
CT03354	SPC335-04	4	335	344,6	6	3535	90	20	111	279	11,0	89	11,0	175
CT03554	SPC355-04	4	355	364,6	6	3535	90	20	111	299	11,0	89	11,0	175
CT03754	SPC375-04	4	375	384,6	6	3535	90	25	111	319	11,0	89	11,0	175
CT04004	SPC400-04	4	400	409,6	6	3535	90	18	111	344	11,0	89	11,0	175
CT04254	SPC425-04	4	425	434,6	6	3535	90	18	111	369	11,0	89	11,0	175
CT04504	SPC450-04	4	450	459,6	5	3535	90	-	111	394	11,0	89	11,0	175
CT04754	SPC475-04	4	475	484,6	5	3535	90	-	111	419	11,0	89	11,0	175
CT05004	SPC500-04	4	500	509,6	5	3535	90	-	111	444	11,0	89	11,0	175
CT05304	SPC530-04	4	530	539,6	5	4040	100	-	111	474	4,5	102	4,5	210
CT05604	SPC560-04	4	560	569,6	5	4040	100	-	111	504	4,5	102	4,5	210
CT06304	SPC630-04	4	630	639,6	4	4545	110	-	111	574	1,5	114	1,5	242
CT07104	SPC710-04	4	710	719,6	4	5050	125	-	111	654	8,0	127	8,0	267
CT08004	SPC800-04	4	800	809,6	4	5050	125	-	111	737	8,0	127	8,0	267
CT10004	SPC1000-04	4	1000	1009,6	4	5050	125	-	111	937	8,0	127	8,0	267
CT12504	SPC1250-04	4	1250	1259,6	4	5050	125	-	111	1187	8,0	127	8,0	267

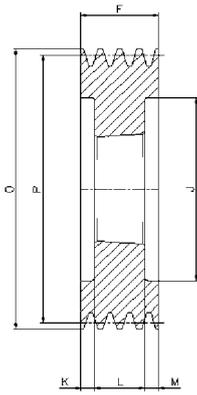

3

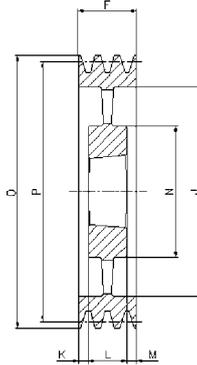

5

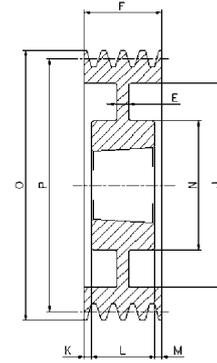

6

# SPC/5

Cod. interno Internal code Innerer Code Code interne Código interno	Tipo Type Typ Type Tipo	Gole Grooves Rillen Gorges Canales	P	O	Forma Form Forme Forme Forma	Bussola Bush Buchse Moyeu Casquillo	∅ MAX	E	F	J	K	L	M	N
CT02005	SPC200-05	5	<b>200</b>	209,6	3	3535	90	-	136	144	23,5	89	23,5	-
CT02125	SPC212-05	5	<b>212</b>	221,6	3	3535	90	-	136	156	23,5	89	23,5	-
CT02245	SPC224-05	5	<b>224</b>	233,6	3	3535	90	-	136	168	23,5	89	23,5	-
CT02365	SPC236-05	5	<b>236</b>	245,6	3	3535	90	-	136	180	23,5	89	23,5	-
CT02505	SPC250-05	5	<b>250</b>	259,6	3	3535	90	-	136	194	23,5	89	23,5	-
CT02655	SPC265-05	5	<b>265</b>	274,6	3	3535	90	-	136	209	23,5	89	23,5	-
CT02805	SPC280-05	5	<b>280</b>	289,6	3	3535	90	-	136	224	23,5	89	23,5	-
CT03005	SPC300-05	5	<b>300</b>	309,6	6	3535	90	20	136	244	23,5	89	23,5	175
CT03155	SPC315-05	5	<b>315</b>	324,6	6	3535	90	20	136	259	23,5	89	23,5	175
CT03355	SPC335-05	5	<b>335</b>	344,6	6	3535	90	20	136	279	23,5	89	23,5	175
CT03555	SPC355-05	5	<b>355</b>	364,6	6	3535	90	20	136	299	23,5	89	23,5	175
CT03755	SPC375-05	5	<b>375</b>	384,6	6	3535	90	25	136	319	23,5	89	23,5	175
CT04005	SPC400-05	5	<b>400</b>	409,6	6	3535	90	15	136	344	23,5	89	23,5	175
CT04255	SPC425-05	5	<b>425</b>	434,6	6	3535	90	20	136	369	23,5	89	23,5	175
CT04505	SPC450-05	5	<b>450</b>	459,6	5	4040	100	-	136	394	17,0	102	17,0	210
CT04755	SPC475-05	5	<b>475</b>	484,6	5	4040	100	-	136	419	17,0	102	17,0	210
CT05005	SPC500-05	5	<b>500</b>	509,6	5	4040	100	-	136	444	17,0	102	17,0	210
CT05305	SPC530-05	5	<b>530</b>	539,6	5	4545	110	-	136	474	11,0	114	11,0	240
CT05605	SPC560-05	5	<b>560</b>	569,6	5	4545	110	-	136	504	11,0	114	11,0	242
CT06305	SPC630-05	5	<b>630</b>	639,6	5	5050	125	-	136	574	4,5	127	4,5	267
CT07105	SPC710-05	5	<b>710</b>	719,6	5	5050	125	-	136	654	4,5	127	4,5	267
CT08005	SPC800-05	5	<b>800</b>	809,6	5	5050	125	-	136	737	4,5	127	4,5	267
CT10005	SPC1000-05	5	<b>1000</b>	1009,6	5	5050	125	-	136	937	4,5	127	4,5	267
CT12505	SPC1250-05	5	<b>1250</b>	1259,6	5	5050	125	-	136	1187	4,5	127	4,5	267

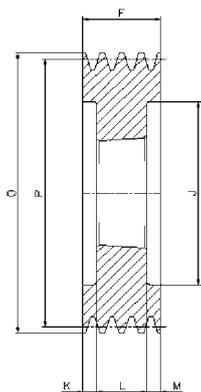

3

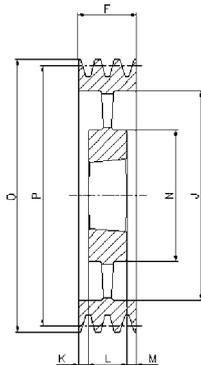

5

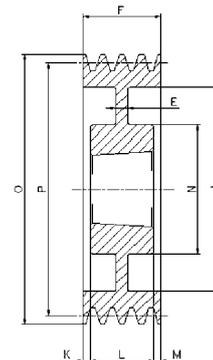

6

# SPC/6

Cod. interno Internal code Innerer Code Code interne Código interno	Tipo Type Typ Type Tipo	Gole Grooves Rillen Gorges Canales	P	O	Forma Form Forme Forme Forma	Bussola Bush Buchse Moyeu Casquillo	∅ MAX	E	F	J	K	L	M	N
CT02006	SPC200-06	6	<b>200</b>	209,6	3	3535	90	-	162	144	36,5	89	36,5	-
CT02126	SPC212-06	6	<b>212</b>	221,6	3	3535	90	-	162	156	36,5	89	36,5	-
CT02246	SPC224-06	6	<b>224</b>	233,6	3	3535	90	-	162	168	36,5	89	36,5	-
CT02366	SPC236-06	6	<b>236</b>	245,6	3	3535	90	-	162	180	36,5	89	36,5	-
CT02506	SPC250-06	6	<b>250</b>	259,6	3	3535	90	-	162	194	36,5	89	36,5	-
CT02656	SPC265-06	6	<b>265</b>	274,6	3	3535	90	-	162	209	36,5	89	36,5	-
CT02806	SPC280-06	6	<b>280</b>	289,6	6	3535	90	20	162	224	36,5	89	36,5	175
CT03006	SPC300-06	6	<b>300</b>	309,6	6	3535	90	20	162	244	36,5	89	36,5	175
CT03156	SPC315-06	6	<b>315</b>	324,6	6	3535	90	20	162	259	36,5	89	36,5	175
CT03356	SPC335-06	6	<b>335</b>	344,6	6	3535	90	20	162	279	36,5	89	36,5	175
CT03556	SPC355-06	6	<b>355</b>	364,6	6	3535	90	20	162	299	36,5	89	36,5	175
CT03756	SPC375-06	6	<b>375</b>	384,6	6	4040	100	30	162	319	30,0	102	30,0	210
CT04006	SPC400-06	6	<b>400</b>	409,6	6	4040	100	30	162	344	30,0	102	30,0	210
CT04256	SPC425-06	6	<b>425</b>	434,6	6	4040	100	30	162	369	30,0	102	24,0	210
CT04506	SPC450-06	6	<b>450</b>	459,6	6	4545	110	30	162	394	24,0	114	24,0	242
CT04756	SPC475-06	6	<b>475</b>	484,6	6	4545	110	30	162	419	24,0	114	24,0	242
CT05006	SPC500-06	6	<b>500</b>	509,6	5	4545	110	-	162	444	24,0	114	24,0	242
CT05306	SPC530-06	6	<b>530</b>	539,6	5	5050	125	-	162	474	17,5	114	17,5	265
CT05606	SPC560-06	6	<b>560</b>	569,6	5	5050	125	-	162	504	17,5	127	17,5	267
CT06306	SPC630-06	6	<b>630</b>	639,6	5	5050	125	-	162	574	17,5	127	17,5	267
CT07106	SPC710-06	6	<b>710</b>	719,6	5	5050	125	-	162	654	17,5	127	17,5	267
CT08006	SPC800-06	6	<b>800</b>	809,6	5	5050	125	-	162	737	17,5	127	17,5	267
CT10006	SPC1000-06	6	<b>1000</b>	1009,6	5	5050	125	-	162	937	17,5	127	17,5	267
CT12506	SPC1250-06	6	<b>1250</b>	1259,6	5	5050	125	-	162	1187	17,5	127	17,5	267

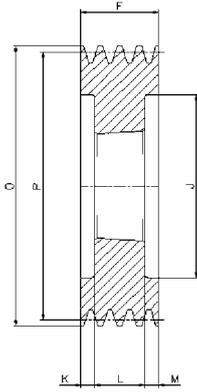

3

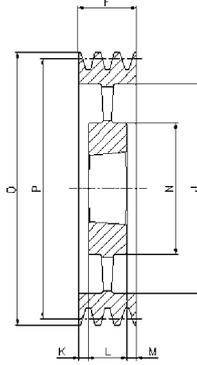

5

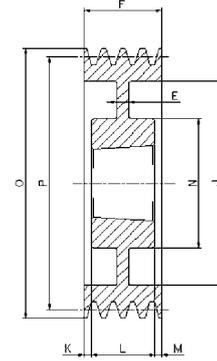

6

# SPC/8

Cod. interno Internal code Innerer Code Code interne Código interno	Tipo Type Typ Type Tipo	Gole Grooves Rillen Gorges Canales	P	O	Forma Form Forme Forme Forma	Bussola Bush Buchse Moyeu Casquillo	Ø MAX	E	F	J	K	L	M	N
CT02008	SPC200-08	8	<b>200</b>	209,6	3	3535	90	-	213	144	62,0	89	62,0	-
CT02128	SPC212-08	8	<b>212</b>	221,6	3	3535	90	-	213	156	62,0	89	62,0	-
CT02248	SPC224-08	8	<b>224</b>	233,6	3	3535	90	-	213	168	62,0	89	62,0	-
CT02368	SPC236-08	8	<b>236</b>	245,6	3	3535	90	-	213	180	62,0	89	62,0	-
CT02508	SPC250-08	8	<b>250</b>	259,6	3	3535	90	-	213	194	62,0	89	62,0	-
CT02658	SPC265-08	8	<b>265</b>	274,6	3	3535	90	-	213	209	62,0	89	62,0	-
CT02808	SPC280-08	8	<b>280</b>	289,6	3	3535	90	-	213	224	62,0	89	62,0	-
CT03008	SPC300-08	8	<b>300</b>	309,6	3	4040	100	-	213	244	55,5	102	55,5	-
CT03158	SPC315-08	8	<b>315</b>	324,6	3	4040	100	-	213	259	55,5	102	55,5	-
CT03358	SPC335-08	8	<b>335</b>	344,6	6	4040	100	50	213	279	55,5	102	55,5	210
CT03558	SPC355-08	8	<b>355</b>	364,6	6	4040	100	40	213	299	55,5	102	55,5	210
CT03758	SPC375-08	8	<b>375</b>	384,6	6	4545	110	30	213	319	49,5	114	49,5	242
CT04008	SPC400-08	8	<b>400</b>	409,6	6	4545	110	30	213	344	49,5	114	49,5	242
CT04258	SPC425-08	8	<b>425</b>	434,6	6	4545	110	30	213	369	49,5	114	49,5	240
CT04508	SPC450-08	8	<b>450</b>	459,6	6	5050	125	30	213	394	43,0	127	43,0	267
CT04758	SPC475-08	8	<b>475</b>	484,6	6	5050	125	30	213	419	43,0	127	43,0	267
CT04998	SPC500-08	8	<b>500</b>	509,6	6	5050	125	30	213	444	43,0	127	43,0	267
CT05308	SPC530-08	8	<b>530</b>	539,6	6	5050	125	30	213	474	43,0	127	43,0	267
CT05608	SPC560-08	8	<b>560</b>	569,6	5	5050	125	-	213	504	43,0	127	43,0	267
CT06308	SPC630-08	8	<b>630</b>	639,6	5	5050	125	-	213	574	43,0	127	43,0	267
CT07108	SPC710-08	8	<b>710</b>	719,6	5	5050	125	-	213	654	43,0	127	43,0	267
CT08008	SPC800-08	8	<b>800</b>	809,6	5	5050	125	-	213	737	43,0	127	43,0	267
CT09998	SPC1000-08	8	<b>1000</b>	1009,6	5	5050	125	-	213	937	43,0	127	43,0	267
CT12508	SPC1250-08	8	<b>1250</b>	1259,6	5	5050	125	-	213	1187	43,0	127	43,0	267



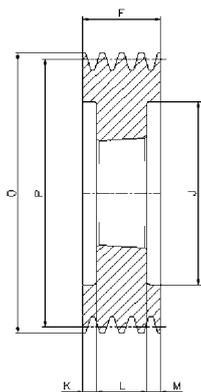

3

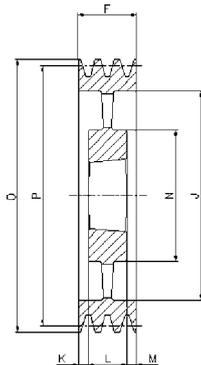

5

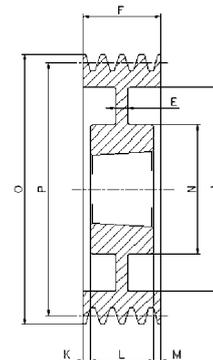

6

# SPC/10

Cod. interno Internal code Innerer Code Code interne Código interno	Tipo Type Typ Type Tipo	Gole Grooves Rillen Gorges Canales	P	O	Forma Form Forme Forme Forma	Bussola Bush Buchse Moyeu Casquillo	∅ MAX	E	F	J	K	L	M	N
CT0250X	SPC250-10	10	<b>250</b>	259,6	3	4040	100	-	264	194	81,0	102	81,0	-
CT0280X	SPC280-10	10	<b>280</b>	289,6	3	4040	100	-	264	224	81,0	102	81,0	-
CT0300X	SPC300-10	10	<b>300</b>	309,6	3	4545	110	-	264	244	75,0	114	75,0	-
CT0315X	SPC315-10	10	<b>315</b>	324,6	3	4545	110	-	264	259	75,0	114	75,0	-
CT0355X	SPC355-10	10	<b>355</b>	364,6	3	4545	110	-	264	299	75,0	114	75,0	-
CT0375X	SPC375-10	10	<b>375</b>	384,6	3	4545	110	-	264	316	75,0	114	75,0	-
CT0400X	SPC400-10	10	<b>400</b>	409,6	6	5050	125	70	264	344	68,5	127	68,5	267
CT0450X	SPC450-10	10	<b>450</b>	459,6	6	5050	125	40	264	394	68,5	127	68,5	267
CT0500X	SPC500-10	10	<b>500</b>	509,6	6	5050	125	40	264	444	68,5	127	68,5	267
CT0560X	SPC560-10	10	<b>560</b>	569,6	5	5050	125	-	264	504	68,5	127	68,5	267
CT0630X	SPC630-10	10	<b>630</b>	639,6	5	5050	125	-	264	574	68,5	127	68,5	267
CT0710X	SPC710-10	10	<b>710</b>	719,6	5	5050	125	-	264	654	68,5	127	68,5	267
CT0800X	SPC800-10	10	<b>800</b>	809,6	5	5050	125	-	264	737	68,5	127	68,5	267
CT1000X	SPC1000-10	10	<b>1000</b>	1009,6	5	5050	125	-	264	937	68,5	127	68,5	267
CT1250X	SPC1250-10	10	<b>1250</b>	1259,6	5	5050	125	-	264	1187	68,5	127	68,5	267



**Pullegge trapezoidali monoblocco**  
**V-Belt pulleys with solid hub**  
**Keilriemenscheiben ungebohrt**  
**Poulies trapézoidales moyeu plein**  
**Poleas trapezoidales con cubo macizo**

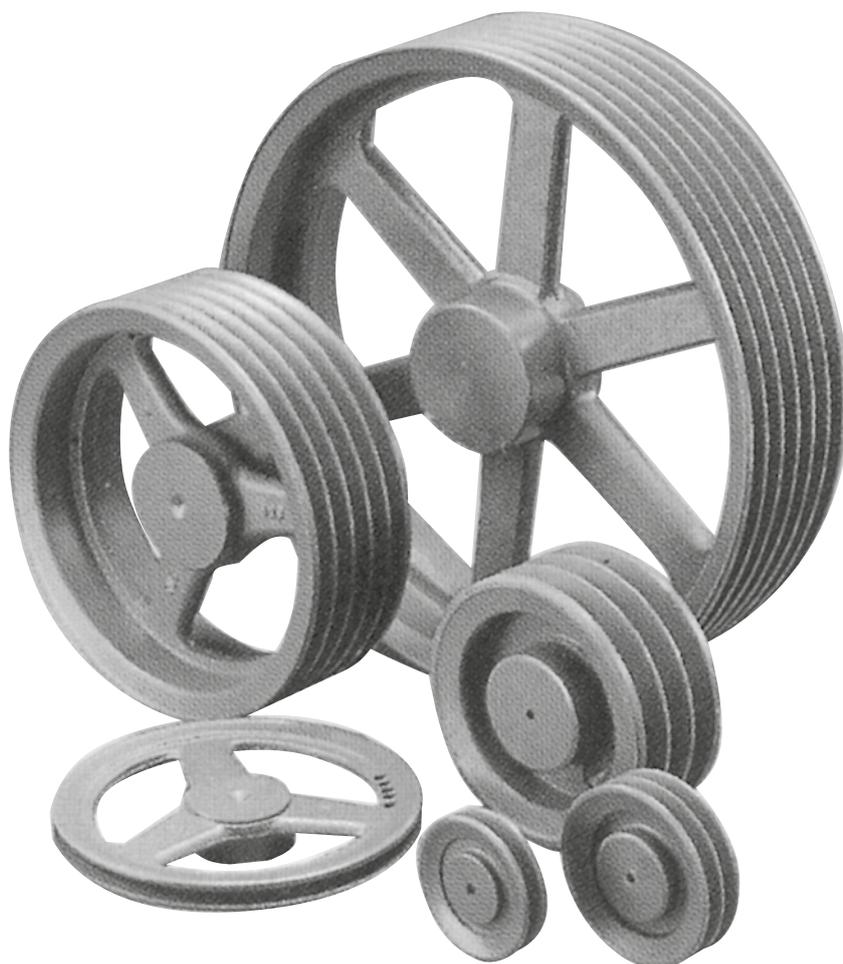

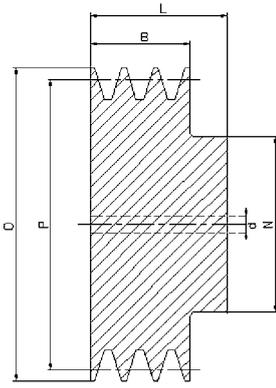

**1**

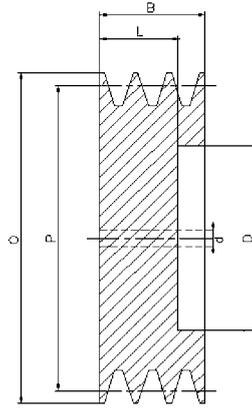

**2**

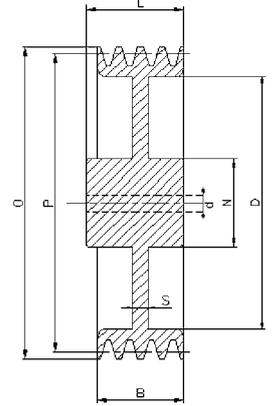

**3**

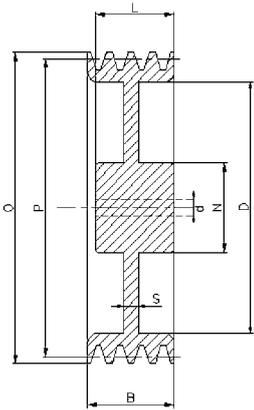

**4**

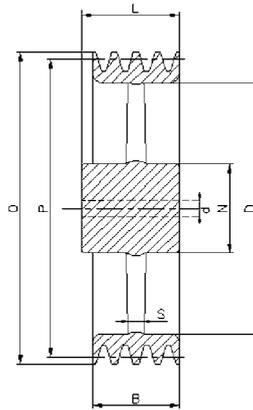

**5**

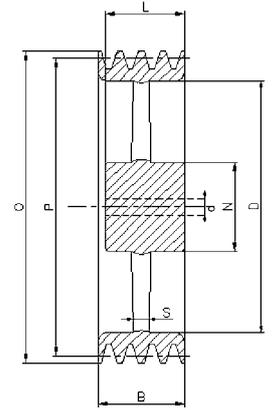

**6**

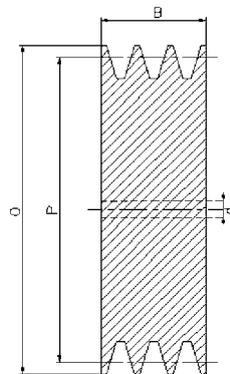

**7**

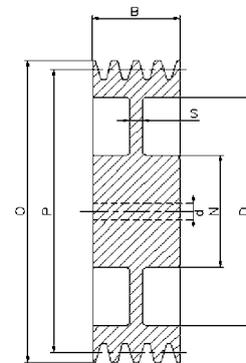

**8**

Cod. interno Internal code Innerer Code Code interne Código interno	Descrizione Description Beschreibung Description Descripción	P	O	Gole Grooves Rillen Gorges Canales	N	L	D	S	B	Forma Form Forme Forme Forma	d	Peso Weight Gewicht Poids Peso
ZM00501	SPZ50	<b>50</b>	54	1	40	28			16	1	10	
ZM00502				2	40	35			28	1	10	
ZM00503				3					40	7	10	
ZM00561	SPZ56	<b>56</b>	60	1	45	28			16	1	10	
ZM00562				2	45	35			28	1	10	
ZM00563				3					40	7	10	
ZM00631	SPZ63	<b>63</b>	67	1	50	28			16	1	10	
ZM00632				2	50	35			28	1	10	
ZM00633				3					40	7	10	
ZM00711	SPZ71	<b>71</b>	75	1	50	28			16	1	10	
ZM00712				2	55	35			28	1	10	
ZM00713				3					40	7	10	
ZM00751	SPZ75	<b>75</b>	79	1	50	28			16	1	10	
ZM00752				2	60	35			28	1	10	
ZM00753				3					40	7	10	
ZM00801	SPZ80	<b>80</b>	84	1	50	28			16	1	10	
ZM00802				2	60	35			28	1	10	
ZM00803				3					40	7	10	
ZM00851	SPZ85	<b>85</b>	89	1	50	28			16	1	10	
ZM00852				2	60	35			28	1	10	
ZM00853				3					40	7	15	
ZM00901	SPZ90	<b>90</b>	94	1	50	28			16	1	10	
ZM00902				2	60	35			28	1	10	
ZM00903				3					40	7	15	
ZM00951	SPZ95	<b>95</b>	99	1	50	28			16	1	10	
ZM00952				2	60	35			28	1	15	
ZM00953				3					40	7	15	
ZM01001	SPZ100	<b>100</b>	104	1	50	28			16	1	10	
ZM01002				2	60	35			28	1	15	
ZM01003				3					40	7	15	
ZM01061	SPZ106	<b>106</b>	110	1	50	28			16	1	10	
ZM01062				2	60	35			28	1	15	
ZM01063				3					40	7	15	
ZM01121	SPZ112	<b>112</b>	116	1	50	28			16	1	10	
ZM01122				2	60	35			28	1	15	
ZM01123				3					40	7	15	
ZM01181	SPZ118	<b>118</b>	122	1	50	28	93	8	16	3	10	
ZM01182				2	60	35	91	8	28	3	15	
ZM01183				3					40	7	15	
ZM01251	SPZ125	<b>125</b>	129	1	50	28	100	8	16	3	15	
ZM01252				2	60	35	99	8	28	3	15	
ZM01253				3					40	7	15	

Cod. interno Internal code Innerer Code Code interne Código interno	Descrizione Description Beschreibung Description Descripción	P	O	Gole Grooves Rillen Gorges Canales	N	L	D	S	B	Forma Form Forme Forme Forma	d	Peso Weight Gewicht Poids Peso
ZM01321	SPZ132	<b>132</b>	136	1	50	28	106	8	16	3	15	
ZM01322				2	60	40	106	8	28	3	15	
ZM01323				3	60	40	106	8	40	8	15	
ZM01401	SPZ140	<b>140</b>	144	1	50	28	114	8	16	3	15	
ZM01402				2	60	40	114	8	28	3	15	
ZM01403				3	60	40	114	8	40	8	15	
ZM01501	SPZ150	<b>150</b>	154	1	50	28	124	8	16	3	15	
ZM01502				2	60	40	124	8	28	3	15	
ZM01503				3	60	40	124	8	40	8	20	
ZM01601	SPZ160	<b>160</b>	164	1	55	32	134	8	16	3	15	
ZM01602				2	60	40	134	8	28	3	15	
ZM01603				3	65	45	134	8	40	3	20	
ZM01801	SPZ180	<b>180</b>	184	1	55	32	154	8	16	5	20	
ZM01802				2	60	40	154	8	28	5	20	
ZM01803				3	65	45	154	8	40	5	20	
ZM02001	SPZ200	<b>200</b>	204	1	55	32	174	8	16	5	20	
ZM02002				2	60	40	174	8	28	5	20	
ZM02003				3	65	45	174	10	40	5	20	
ZM02241	SPZ224	<b>224</b>	228	1	55	32	198	8	16	5	20	
ZM02242				2	60	40	198	8	28	5	20	
ZM02243				3	65	45	198	10	40	5	20	
ZM02501	SPZ250	<b>250</b>	254	1	55	32	224	8	16	5	20	
ZM02502				2	60	40	224	10	28	5	20	
ZM02503				3	65	45	224	12	40	5	20	
ZM02802	SPZ280	<b>280</b>	284	2	65	45	254	10	28	5	20	
ZM03152	SPZ315	<b>315</b>	319	2	65	45	289	10	28	5	20	

Cod. interno Internal code Innerer Code Code interne Código interno	Descrizione Description Beschreibung Description Descripción	P	O	Gole Grooves Rillen Gorges Canales	N	L	D	S	B	Forma Form Forme Forme Forma	d	Peso Weight Gewicht Poids Peso
AM00401	SPA40	<b>40</b>	45,5	1	40	35			20	1	10	
AM00501	SPA50	<b>50</b>	55,5	1	40	35			20	1	10	
AM00502				2	40	45			35	1	10	
AM00561	SPA56	<b>56</b>	61,5	1	40	35			20	1	10	
AM00562				2	40	45			35	1	10	
AM00563				3					50	7	10	
AM00603	SPA60	<b>60</b>	65,5	1	40	35			20	1	10	
AM00631	SPA63	<b>63</b>	68,5	1	40	35			20	1	10	
AM00632				2	40	45			35	1	10	
AM00633				3					50	7	10	
AM00711	SPA71	<b>71</b>	76,5	1	40	40			20	1	10	
AM00712				2	50	45			35	1	10	
AM00713				3					50	7	10	
AM00751	SPA75	<b>75</b>	80,5	1	40	40			20	1	10	
AM00752				2	50	45			35	1	10	
AM00753				3					50	7	10	
AM00754				4					65	7	10	
AM00755				5					80	7	10	
AM00801	SPA80	<b>80</b>	85,5	1	45	40			20	1	10	
AM00802				2	50	45			35	1	10	
AM00803				3					50	7	15	
AM00804				4					65	7	15	
AM00805				5					80	7	15	
AM00851	SPA85	<b>85</b>	90,5	1	45	40			20	1	10	
AM00852				2	50	45			35	1	10	
AM00853				3					50	7	15	
AM00854				4					65	7	15	
AM00855				5					80	7	15	
AM00901	SPA90	<b>90</b>	95,5	1	45	40			20	1	10	
AM00902				2	60	45			35	1	15	
AM00903				3					50	7	15	
AM00904				4					65	7	15	
AM00905				5					80	7	15	
AM00951	SPA95	<b>95</b>	100,5	1	45	40			20	1	10	
AM00952				2	60	45			35	1	15	
AM00953				3					50	7	15	
AM00954				4					65	7	15	
AM00955				5					80	7	15	
AM01001	SPA100	<b>100</b>	105,5	1	48	40			20	1	10	
AM01002				2	60	45			35	1	15	
AM01003				3					50	7	15	
AM01004				4		52	67		65	2	15	
AM01005				5		52	67		80	2	15	
AM01061	SPA106	<b>106</b>	111,5	1	48	40			20	1	10	
AM01062				2	60	45			35	1	15	
AM01063				3					50	7	15	
AM01065				5		52	67		80	2	15	
AM01121	SPA112	<b>112</b>	117,5	1	48	40			20	1	10	
AM01122				2	60	45			35	1	15	
AM01123				3					50	7	15	
AM01124				4		52	79		65	2	15	
AM01125				5		52	79		80	2	15	
AM01181	SPA118	<b>118</b>	123,5	1	60	40			20	1	15	
AM01182				2	60	45			35	1	15	
AM01183				3					50	7	15	
AM01184				4		52	87		65	2	15	
AM01185				5		52	87		80	2	15	

Cod. interno Internal code Innerer Code Code interne Código interno	Descrizione Description Beschreibung Description Descripción	P	O	Gole Grooves Rillen Gorges Canales	N	L	D	S	B	Forma Form Forme Forme Forma	d	Peso Weight Gewicht Poids Peso
AM01251	SPA125	<b>125</b>	130,5	1	60	40			20	1	15	
AM01252				2	60	45			35	1	15	
AM01253				3					50	7	15	
AM01254				4		52	97		65	2	15	
AM01321	SPA132	<b>132</b>	137,5	1	60	40			20	1	15	
AM01322				2	60	45			35	1	15	
AM01323				3					50	7	15	
AM01324				4		52	97		65	2	15	
AM01325				5		52	97		80	2	15	
AM01401	SPA140	<b>140</b>	145,5	1	60	40	107	10	20	3	15	
AM01402				2	60	45	107	10	35	3	15	
AM01403				3	65	52	107	18	50	3	20	
AM01404				4		52	107		65	2	20	
AM01405				5		52	107		80	2	20	
AM01501	SPA150	<b>150</b>	155,5	1	60	40	117	10	20	3	15	
AM01502				2	60	45	117	10	35	3	15	
AM01503				3	65	52	117	18	50	3	20	
AM01504				4		52	117		65	2	20	
AM01505				5		52	117		80	2	20	
AM01601	SPA160	<b>160</b>	165,5	1	60	40	127	10	20	3	15	
AM01602				2	60	45	127	10	35	3	15	
AM01603				3	70	52	127	18	50	3	20	
AM01604				4	70	52	127	22	65	4	20	
AM01605				5	80	52	127	22	80	4	20	
AM01701	SPA170	<b>170</b>	175,5	1	60	40	137	10	20	3	15	
AM01702				2	60	45	137	10	35	3	15	
AM01703				3	70	52	137	18	50	3	20	
AM01704				4	80	52	137	18	65	4	20	
AM01705				5	80	52	137	18	80	4	20	
AM01801	SPA180	<b>180</b>	185,5	1	65	40	147	10	20	3	20	
AM01802				2	70	50	147	12	35	3	20	
AM01803				3	70	52	147	12	50	3	20	
AM01804				4	80	60	147	22	65	4	20	
AM01805				5	80	65	147	22	80	4	20	
AM01902	SPA190	<b>190</b>	195,5	2	70	50	157	12	35	3	20	
AM01903				3	70	52	157	12	50	3	20	
AM01904				4	80	60	157	18	65	4	20	
AM02001	SPA200	<b>200</b>	205,5	1	65	45	167	10	20	3	20	
AM02002				2	70	50	167	12	35	3	20	
AM02003				3	70	52	167	12	50	3	20	
AM02004				4	80	60	167	18	65	4	20	
AM02005				5	80	65	167	20	80	4	20	
AM02121	SPA212	<b>212</b>	217,5	1	65	40		10	20	3	20	
AM02122				2	70	45		12	35	3	20	
AM02241	SPA224	<b>224</b>	229,5	1	65	45	192	10	20	3	20	
AM02242				2	70	50	192	12	35	3	20	
AM02243				3	80	52	192	12	50	3	20	
AM02244				4	90	60	192	18	65	4	20	
AM02245				5	90	65	192	20	80	4	20	
AM02361	SPA236	<b>236</b>	241,5	1		50		12	20	3	20	
AM02362				2		50		12	35	3	20	
AM02501	SPA250	<b>250</b>	255,5	1	75	50	217	12	20	3	20	
AM02502				2	75	50	217	12	35	3	20	
AM02503				3	80	60	217	12	50	3	20	
AM02504				4	90	65	217	18	65	3	20	
AM02505				5	90	65	217	20	80	4	20	
AM02801	SPA280	<b>280</b>	285,5	1	75	50	247	14	20	5	20	
AM02802				2	80	50	247	14	35	5	20	
AM02803				3	80	60	247	14	50	5	20	
AM02804				4	90	65	247	16	65	5	20	
AM02805				5	100	65	247	18	80	6	25	



Cod. interno Internal code Innerer Code Code interne Código interno	Descrizione Description Beschreibung Description Descripción	P	O	Gole Grooves Rillen Gorges Canales	N	L	D	S	B	Forma Form Forme Forme Forma	d	Peso Weight Gewicht Poids Peso
AM03001	SPA300	<b>300</b>	305,5	1	75	50	267	14	20	5	20	
AM03002				2	80	50	267	14	35	5	20	
AM03003				3	80	60	267	14	50	5	20	
AM03004				4	90	65	267	16	65	5	20	
AM03005				5	100	65	267	18	80	6	25	
AM03151	SPA315	<b>315</b>	320,5	1	75	60	282	14	20	5	20	
AM03152				2	80	50	282	14	35	5	20	
AM03153				3	90	60	282	14	50	5	20	
AM03154				4	90	65	282	16	65	5	20	
AM03155				5	100	65	282	18	80	6	25	
AM03551	SPA355	<b>355</b>	360,5	1	75	50	322	14	20	5	20	
AM03552				2	80	50	322	14	35	5	20	
AM03553				3	90	60	322	14	50	5	20	
AM03554				4	90	65	322	16	65	5	25	
AM03555				5	100	65	322	18	80	6	25	
AM04001	SPA400	<b>400</b>	405,5	1	90	50	367	14	20	5	20	
AM04002				2	90	50	367	14	35	5	20	
AM04003				3	100	60	367	16	50	5	25	
AM04004				4	100	65	367	20	65	5	25	
AM04005				5	100	65	367	22	80	6	25	
AM04501	SPA450	<b>450</b>	455,5	1	90	50	417	14	20	5	20	
AM04502				2	100	50	417	14	35	5	25	
AM04503				3	100	60	417	16	50	5	25	
AM04504				4	105	65	417	20	65	6	25	
AM04505				5	105	65	417	22	80	6	25	
AM05001	SPA500	<b>500</b>	505,5	1	90	50	467	14	20	5	20	
AM05002				2	100	50	467	16	35	5	25	
AM05003				3	105	60	467	20	50	5	25	
AM05004				4	105	65	467	20	65	6	25	
AM05005				5	110	65	467	22	80	6	25	
AM05601	SPA560	<b>560</b>	565,5	1	100	50	527	15	20	5	25	
AM05602				2	100	50	527	18	35	5	25	
AM05603				3	120	65	527	20	50	5	25	
AM05604				4	120	65	527	22	65	5	25	
AM05605				5	120	80	527	24	80	5	25	
AM05606				6	120	80	527	26	95	6	25	
AM06301	SPA630	<b>630</b>	635,5	1	100	50	597	16	20	5	25	
AM06302				2	110	50	597	18	35	5	25	
AM06303				3	120	65	597	20	50	5	25	
AM06304				4	120	65	597	22	65	5	25	
AM06305				5	120	80	597	24	80	5	25	
AM06306				6	120	80	597	26	95	6	25	

Cod. interno Internal code Innerer Code Code interne Código interno	Descrizione Description Beschreibung Description Descripción	P	O	Gole Grooves Rillen Gorges Canales	N	L	D	S	B	Forma Form Forme Forme Forma	d	Peso Weight Gewicht Poids Peso
BM00631	SPB63	<b>63</b>	70	1	45	45			25	1	10	
BM00701	SPB70	<b>70</b>	77	1	45	45			25	1	10	
BM00702				2	45	55			44	1	10	
BM00713	SPB71	<b>71</b>	78	3					63	7	15	
BM00801	SPB80	<b>80</b>	87	1	50	45			25	1	10	
BM00802				2	50	55			44	1	10	
BM00803				3					63	7	15	
BM00804				4					82	7	15	
BM00805				5					101	7	15	
BM00851	SPB85	<b>85</b>	92	1	50	45			25	1	10	
BM00852				2	50	55			44	1	10	
BM00853				3	-	-			63	7	15	
BM00901	SPB90	<b>90</b>	97	1	50	45			25	1	10	
BM00902				2	50	55			44	1	10	
BM00903				3					63	7	15	
BM00904				4					82	7	15	
BM00905				5					101	7	15	
BM00951	SPB95	<b>95</b>	102	1	50	45			25	1	10	
BM01001	SPB100	<b>100</b>	107	1	52	45			25	1	10	
BM01002				2	55	55			44	1	15	
BM01003				3					63	7	15	
BM01004				4					82	7	15	
BM01005				5					101	7	15	
BM01061	SPB106	<b>106</b>	113	1		45			25	1	15	
BM01062				2		55			44	1	15	
BM01121	SPB112	<b>112</b>	119	1	55	45			25	1	15	
BM01122				2	60	55			44	1	15	
BM01123				3					63	7	15	
BM01124				4					82	7	20	
BM01125				5					101	7	20	
BM01181	SPB118	<b>118</b>	125	1	55	45			25	1	15	
BM01182				2	60	55			44	1	15	
BM01183				3					63	7	15	
BM01184				4					82	7	20	
BM01185				5					101	7	20	
BM01186				6					120	7	20	
BM01201	SPB120	<b>120</b>	127	1	55	45			25	1	15	
BM01202				2	60	55			44	1	15	
BM01203				3					63	7	15	
BM01204				4					82	7	20	
BM01205				5					101	7	20	
BM01206				6					120	7	20	
BM01251	SPB125	<b>125</b>	132	1	58	45			25	1	10	
BM01252				2	60	55			44	1	15	
BM01253				3		60	83		63	2	15	
BM01254				4		60	83		82	2	20	
BM01255				5		60	83		101	2	20	
BM01256				6		60	83		120	2	20	
BM01321	SPB132	<b>132</b>	139	1	60	45			25	1	15	
BM01322				2	60	55			44	1	15	
BM01323				3		60	88		63	2	15	
BM01324				4		60	88		82	2	20	
BM01325				5		60	88		101	2	20	
BM01326				6		60	88		120	2	20	
BM01401	SPB140	<b>140</b>	147	1	65	45			25	1	20	
BM01402				2	65	55			44	1	20	
BM01403				3		60	98		63	2	20	
BM01404				4		60	98		82	2	20	
BM01405				5		60	98		101	2	20	
BM01406				6		60	98		120	2	20	
BM01501	SPB150	<b>150</b>	157	1	65	45			25	1	20	
BM01502				2	65	55			44	1	20	
BM01503				3		60	108		63	2	20	
BM01504				4		60	108		82	2	20	
BM01505				5		60	108		101	2	20	
BM01506				6		60	108		120	2	20	

Cod. interno Internal code Innerer Code Code interne Código interno	Descrizione Description Beschreibung Description Descripción	P	O	Gole Grooves Rillen Gorges Canales	N	L	D	S	B	Forma Form Forme Forme Forma	d	Peso Weight Gewicht Poids Peso
BM01601	SPB160	<b>160</b>	167	1	65	45	118	12	25	3	20	
BM01602				2	70	55	118	12	44	3	20	
BM01603				3		60	118		63	2	20	
BM01604				4		60	118		82	2	20	
BM01605				5		60	118		101	2	20	
BM01606				6		65	118		120	2	20	
BM01701	SPB170	<b>170</b>	177	1	65	45	128	12	25	3	20	
BM01702				2	70	55	128	12	44	3	20	
BM01703				3	70	60	128	30	63	4	20	
BM01704				4	70	60	128	30	82	4	20	
BM01705				5	70	60	128	30	101	4	20	
BM01706				6	70	65	128	40	120	4	20	
BM01801	SPB180	<b>180</b>	187	1	65	45	138	12	25	3	20	
BM01802				2	70	55	138	12	44	3	20	
BM01803				3	80	60	138	18	63	4	20	
BM01804				4	80	60	138	30	82	4	20	
BM01805				5	80	70	138	40	101	4	20	
BM01806				6	80	70	138	40	120	4	20	
BM01901	SPB190	<b>190</b>	197	1	65	45	148	12	25	3	20	
BM01902				2	70	55	148	12	44	3	20	
BM02001	SPB200	<b>200</b>	207	1	70	45	158	14	25	3	20	
BM02002				2	70	55	158	12	44	3	20	
BM02003				3	80	60	158	18	63	4	20	
BM02004				4	88	60	158	25	82	4	20	
BM02005				5	96	70	158	35	101	4	25	
BM02006				6	96	70	158	40	120	4	25	
BM02121	SPB212	<b>212</b>	219	1	70	45	170	14	25	3	20	
BM02122				2	77	55	170	14	44	3	20	
BM02123				3	80	60	170	18	63	4	20	
BM02124				4	88	60	170	25	82	4	20	
BM02125				5	96	70	170	30	101	4	25	
BM02126				6	104	80	170	45	120	4	25	
BM02241	SPB224	<b>224</b>	231	1	70	45	183	14	25	3	20	
BM02242				2	77	55	183	14	44	3	20	
BM02243				3	80	60	183	18	63	4	20	
BM02244				4	88	60	183	25	82	4	20	
BM02245				5	96	70	183	25	101	4	25	
BM02246				6	104	80	183	30	120	4	25	
BM02501	SPB250	<b>250</b>	257	1	70	50	208	14	25	3	20	
BM02502				2	77	55	208	14	44	3	20	
BM02503				3	80	60	208	18	63	4	20	
BM02504				4	96	65	208	25	82	4	25	
BM02505				5	104	75	208	25	101	4	25	
BM02506				6	104	80	208	25	120	4	25	
BM02801	SPB280	<b>280</b>	287	1	76	50	238	14	25	3	20	
BM02802				2	80	55	238	14	44	3	20	
BM02803				3	90	60	238	18	63	4	20	
BM02804				4	96	65	238	25	82	4	25	
BM02805				5	104	75	238	25	101	4	25	
BM02806				6	104	80	238	25	120	4	25	
BM03001	SPB300	<b>300</b>	307	1	76	50	258	15	25	5	20	
BM03002				2	80	55	258	15	44	5	20	
BM03003				3	90	60	258	18	63	6	20	
BM03004				4	96	65	258	20	82	6	25	
BM03005				5	104	75	258	22	101	6	25	
BM03006				6	104	80	258	24	120	6	25	

Cod. interno Internal code Innerer Code Code interne Código interno	Descrizione Description Beschreibung Description Descripción	P	O	Gole Grooves Rillen Gorges Canales	N	L	D	S	B	Forma Form Forme Forme Forma	d	Peso Weight Gewicht Poids Peso
BM03151	SPB315	<b>315</b>	322	1	76	50	273	15	25	5	20	
BM03152				2	88	60	273	15	44	5	20	
BM03153				3	90	60	273	18	63	6	20	
BM03154				4	96	65	273	20	82	6	25	
BM03155				5	104	75	273	22	101	6	25	
BM03156				6	120	90	273	24	120	6	25	
BM03551	SPB355	<b>355</b>	362	1	80	50	313	15	25	5	20	
BM03552				2	88	60	313	15	44	5	20	
BM03553				3	92	60	313	18	63	6	25	
BM03554				4	96	65	313	20	82	6	25	
BM03555				5	104	75	313	22	101	6	25	
BM03556				6	120	90	313	24	120	6	25	
BM04001	SPB400	<b>400</b>	407	1	85	55	358	18	25	5	20	
BM04002				2	88	60	358	18	44	5	20	
BM04003				3	96	65	358	22	63	5	25	
BM04004				4	104	75	358	24	82	6	25	
BM04005				5	112	85	358	26	101	6	25	
BM04006				6	120	100	358	28	120	6	25	
BM04253	SPB425	<b>425</b>	432	3	96	65	383	22	63	5	20	
BM04254				4	104	75	383	24	82	6	25	
BM04255				5	112	85	383	26	101	6	25	
BM04501	SPB450	<b>450</b>	457	1	90	60	408	18	25	5	20	
BM04502				2	90	60	408	18	44	5	20	
BM04503				3	96	65	408	22	63	5	25	
BM04504				4	104	75	408	24	82	6	25	
BM04505				5	112	85	408	26	101	6	25	
BM04506				6	120	100	408	28	120	6	25	
BM05001	SPB500	<b>500</b>	507	1	100	60	458	18	25	5	25	
BM05002				2	100	65	458	20	44	5	25	
BM05003				3	104	75	458	24	63	5	25	
BM05004				4	112	85	458	28	82	5	25	
BM05005				5	120	90	458	30	101	6	25	
BM05006				6	128	105	458	33	120	6	25	
BM05601	SPB560	<b>560</b>	567	1	100	60	518	18	25	5	25	
BM05602				2	100	65	518	20	44	5	25	
BM05603				3	104	75	518	24	63	5	25	
BM05604				4	112	85	518	28	82	5	25	
BM05605				5	120	90	518	30	101	6	25	
BM05606				6	128	105	518	33	120	6	25	
BM06001	SPB600	<b>600</b>	607	1	100	60	558	18	25	5	25	
BM06002				2	100	65	558	20	44	5	25	
BM06003				3	104	75	558	24	63	5	25	
BM06004				4	115	85	558	28	82	5	25	
BM06005				5	120	90	558	30	101	6	25	
BM06006				6	129	105	558	33	120	6	25	
BM06301	SPB630	<b>630</b>	637	1	100	60	588	18	25	5	25	
BM06302				2	100	65	588	20	44	5	25	
BM06303				3	105	75	588	26	63	5	25	
BM06304				4	120	85	588	28	82	5	25	
BM06305				5	128	90	588	30	101	6	25	
BM06306				6	140	105	588	33	120	6	25	

Cod. interno Internal code Innerer Code Code interne Código interno	Descrizione Description Beschreibung Description Descripción	P	O	Gole Grooves Rillen Gorges Canales	N	L	D	S	B	Forma Form Forme Forme Forma	d	Peso Weight Gewicht Poids Peso							
CM01001	SPC100	<b>100</b>	109,6	1	60	50			34,0	1	15								
CM01201	SPC120	<b>120</b>	129,6	1	65	50			34,0	1	15								
CM01202				2									59,5	7	15				
CM01401	SPC140	<b>140</b>	149,6	1	70	50			34,0	1	20								
CM01402				2									59,5	7	20				
CM01403				3									65	83	85,0	2	20		
CM01404				4									80	83	110,5	2	20		
CM01501	SPC150	<b>150</b>	159,6	1	70	50			34,0	1	20								
CM01502				2									59,5	7	20				
CM01503				3									65	93	85,0	2	20		
CM01504				4									80	93	110,5	2	20		
CM01505				5									96	93	136,0	2	20		
CM01601	SPC160	<b>160</b>	169,6	1	72	50	103		34,0	1	20								
CM01602				2									103	59,5	7	20			
CM01603				3									65	103	85,0	2	20		
CM01604				4									80	103	110,5	2	20		
CM01605				5									96	103	136,0	2	20		
CM01606				6									96	103	161,5	2	20		
CM01801	SPC180	<b>180</b>	189,6	1	76	50	123	16	34,0	3	20								
CM01802				2									80	123	30	59,5	8	20	
CM01803				3									82	65	123	35	85,0	4	20
CM01804				4									82	80	123	60	110,5	4	20
CM01805				5									82	96	123	75	136,0	4	20
CM01806				6									82	96	123	75	161,5	4	20
CM02001	SPC200	<b>200</b>	209,6	1	76	50	143	16	34,0	3	20								
CM02002				2									80	60	143	20	59,5	3	20
CM02003				3									86	65	143	25	85,0	4	20
CM02004				4									90	90	143	70	110,5	4	20
CM02005				5									90	100	143	80	136,0	4	25
CM02006				6									90	100	143	80	161,5	4	25
CM02241	SPC224	<b>224</b>	233,6	1	86	50	168	16	34,0	3	20								
CM02242				2									88	60	168	18	59,5	3	20
CM02243				3									90	70	168	21	85,0	4	20
CM02244				4									90	90	168	50	110,5	4	25
CM02245				5									90	100	168	60	136,0	4	25
CM02246				6									90	100	168	60	161,5	4	25
CM02501	SPC250	<b>250</b>	259,6	1	86	50	193	16	34,0	3	20								
CM02502				2									92	60	193	18	59,5	3	20
CM02503				3									92	70	193	21	85,0	4	20
CM02504				4									100	90	193	30	110,5	4	25
CM02505				5									102	100	193	50	136,0	4	25
CM02506				6									102	100	193	50	161,5	4	25
CM02801	SPC280	<b>280</b>	289,6	1	86	50	223	16	34,0	3	20								
CM02802				2									92	60	223	18	59,5	3	20
CM02803				3									92	70	223	21	85,0	4	20
CM02804				4									100	90	223	25	110,5	4	25
CM02805				5									102	100	223	40	136,0	4	25
CM02806				6									102	100	223	40	161,5	4	25
CM03001	SPC300	<b>300</b>	309,6	1	86	50	243	16	34,0	3	20								
CM03002				2									92	60	243	18	59,5	3	20
CM03003				3									92	70	243	21	85,0	4	20
CM03004				4									100	90	243	25	110,5	4	25
CM03005				5									104	100	243	25	136,0	4	25
CM03006				6									104	100	243	25	161,5	4	25

Cod. interno Internal code Innerer Code Code interne Código interno	Descrizione Description Beschreibung Description Descripción	P	O	Gole Grooves Rillen Gorges Canales	N	L	D	S	B	Forma Form Forme Forme Forma	d	Peso Weight Gewicht Poids Peso
CM03151	SPC315	<b>315</b>	324,6	1	92	50	258	16	34,0	5	20	
CM03152				2	92	60	258	18	59,5	5	20	
CM03153				3	92	70	258	22	85,0	6	25	
CM03154				4	110	90	258	25	110,5	4	25	
CM03155				5	112	100	258	25	136,0	4	25	
CM03156				6	112	100	258	28	161,5	4	25	
CM03351	SPC335	<b>335</b>	344,6	1	100	50	283	16	34,0	5	20	
CM03352				2	100	60	283	18	59,5	5	20	
CM03353				3	100	70	283	22	85,0	6	25	
CM03354				4	114	90	283	25	110,5	6	25	
CM03355				5	114	100	283	28	136,0	6	25	
CM03356				6	114	100	283	30	161,5	6	25	
CM03551	SPC355	<b>355</b>	364,6	1	110	50	298	16	34,0	5	20	
CM03552				2	110	60	298	18	59,5	5	25	
CM03553				3	110	70	298	22	85,0	6	25	
CM03554				4	114	90	298	25	110,5	6	25	
CM03555				5	114	100	298	28	136,0	6	25	
CM03556				6	114	100	298	30	161,5	6	25	
CM04001	SPC400	<b>400</b>	409,6	1	110	60	343	18	34,0	5	25	
CM04002				2	110	70	343	20	59,5	5	25	
CM04003				3	114	90	343	24	85,0	5	25	
CM04004				4	114	90	343	26	110,5	6	25	
CM04005				5	120	100	343	28	136,0	6	25	
CM04006				6	120	100	343	30	161,5	6	25	
CM04501	SPC450	<b>450</b>	459,6	1	110	60	393	18	34,0	5	25	
CM04502				2	110	70	393	20	59,5	5	25	
CM04503				3	114	90	393	24	85,0	5	25	
CM04504				4	120	90	393	28	110,5	6	25	
CM04505				5	120	100	393	30	136,0	6	25	
CM04506				6	120	100	393	32	161,5	6	25	
CM05001	SPC500	<b>500</b>	509,6	1	114	60	443	18	34,0	5	25	
CM05002				2	114	70	443	20	59,5	5	25	
CM05003				3	114	90	443	24	85,0	5	25	
CM05004				4	126	90	443	28	110,5	6	25	
CM05005				5	126	100	443	30	136,0	6	25	
CM05006				6	126	100	443	32	161,5	6	25	
CM05601	SPC560	<b>560</b>	569,6	1	114	60	503	20	34,0	5	25	
CM05602				2	114	70	503	24	59,5	5	25	
CM05603				3	114	90	503	28	85,0	5	25	
CM05604				4	130	100	503	30	110,5	6	25	
CM05605				5	130	100	503	32	136,0	6	25	
CM05606				6	130	100	503	35	161,5	6	25	
CM06001	SPC600	<b>600</b>	609,6	1	114	60	543	20	34,0	5	25	
CM06002				2	114	70	543	24	59,5	5	25	
CM06003				3	114	90	543	28	85,0	5	25	
CM06004				4	130	90	543	30	110,5	6	25	
CM06005				5	130	100	543	32	136,0	6	25	
CM06006				6	130	100	543	35	161,5	6	25	
CM06301	SPC630	<b>630</b>	639,6	1	114	60	573	20	34,0	5	25	
CM06302				2	114	70	573	24	59,5	5	25	
CM06303				3	114	90	573	28	85,0	5	25	
CM06304				4	130	90	573	30	110,5	6	25	
CM06305				5	130	100	573	32	136,0	6	25	
CM06306				6	130	100	573	35	161,5	6	25	

**Motori elettrici**  
**Electric motors**  
**Elektromotoren**  
**Moteurs électriques**  
**Motores eléctricos**

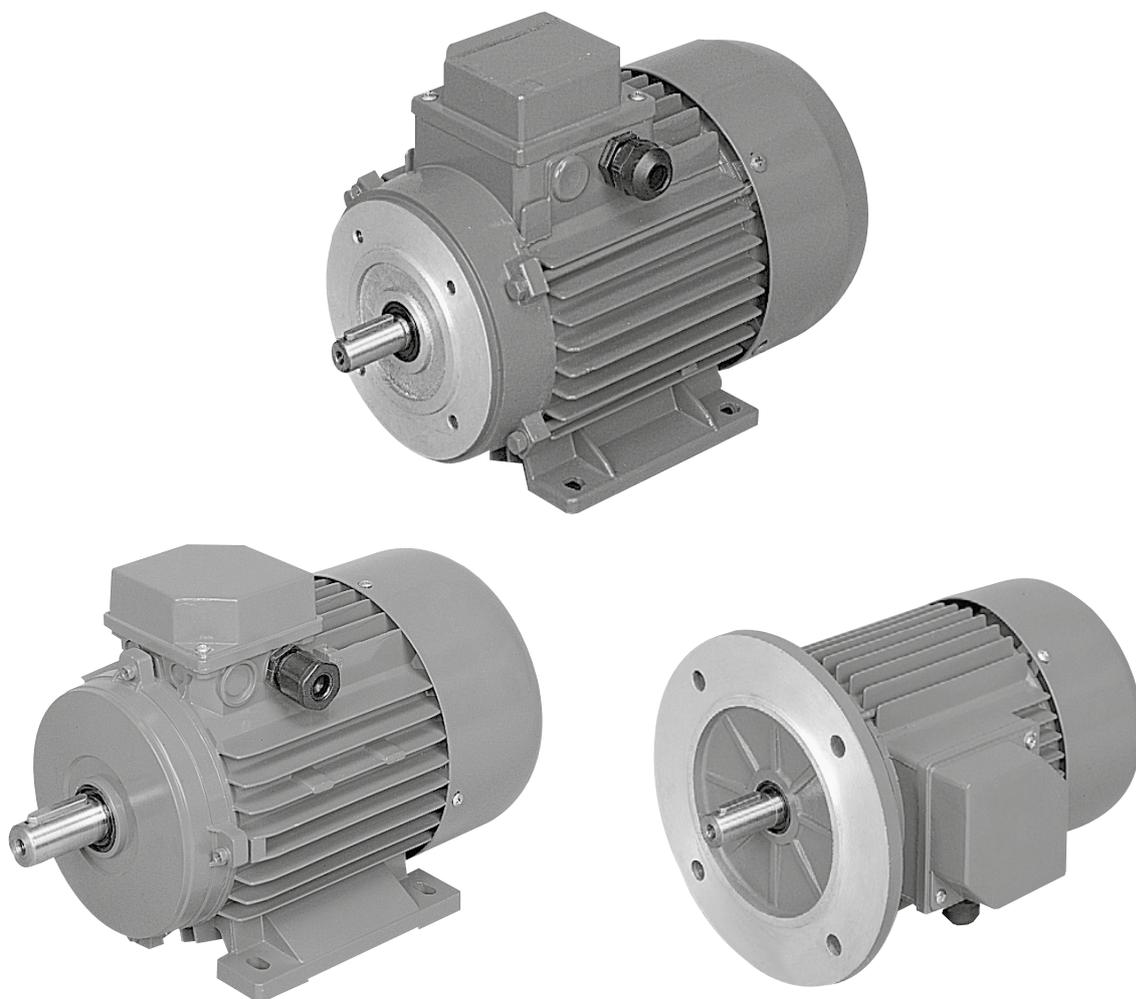

(Prodotto escluso dal campo di applicazione del Sistema Qualità ISO 9001)  
(This product is excluded from the scope of ISO 9001 Quality Management System)  
(Dieses Produkt is vom Anwendungsbereich des Qualitätsmanagementsystems ISO 9001 ausgeschlossen)  
(Ce produit est exclu du domaine d'application du Système de Gestion de la Qualité ISO 9001)  
(Esto producto está excluido del campo de aplicación del Sistema de Gestión de la Calidad ISO 9001)

**Caratteristiche tecniche**
**Technical characteristics**
**Technische Eigenschaften**
**Caracteristiques techniques**
**Características técnicas**
**2 Poli / Poles / Pole / Poles / Polos 2800 rpm**

Nostro codice Our code Unsere kode Notre code Nuestro codigo			Tipo Type Typ Type Tipo	Potenza Power Leistung Puissance Potencia	Potenza Power Leistung Puissance Potencia	Tensione Voltage Spannung Tension Voltaje	Corrente Current Stromstärke Courant Corriente	Velocità Speed Drehzahl Vitesse Velocidad
B5	B3	B14		KW	hp	V	A (400V)	rpm
F100280	F100262	F100261	56A2	0,09	0,12	400	0,36	2800
F100185	F100251	F100101	56B2	0,13	0,18	400	0,39	2800
F100047	F100263	F100227	63A2	0,18	0,25	400	0,52	2800
F100276	F100228	F100281	63B2	0,26	0,35	400	0,67	2800
F100074	F100274	F100177	71A2	0,37	0,50	400	0,92	2800
F100120	F100264	F100075	71B2	0,55	0,75	400	1,32	2800
F100229	F100230	F100277	80A2	0,75	1,00	400	1,74	2800
F100166	F100265	F100275	80B2	1,10	1,50	400	2,48	2800
F100231	F100266	F100285	90S2	1,50	2,00	400	3,25	2800
F100233	F100104	F100267	90L2	2,20	3,00	400	4,62	2800
F100235	F100236	F100308	100A2	3,00	4,00	400	6,07	2800
F100310	F100309	F100323	*112A2	4,00	5,50	400	7,81	2800
F100311	F100312	F100324	*132S2	5,50	7,50	400	10,55	2800
F100223	F100325	F100326	*132L2	7,50	10,00	400	14,30	2800

**4 Poli / Poles / Pole / Poles / Polos 1400 rpm**

Nostro codice Our code Unsere kode Notre code Nuestro codigo			Tipo Type Typ Type Tipo	Potenza Power Leistung Puissance Potencia	Potenza Power Leistung Puissance Potencia	Tensione Voltage Spannung Tension Voltaje	Corrente Current Stromstärke Courant Corriente	Velocità Speed Drehzahl Vitesse Velocidad
B5	B3	B14		KW	hp	V	A (400V)	rpm
F100270	F100278	F100269	50L4	0,06	0,08	400	0,32	1400
F100214	F100282	F100033	56A4	0,09	0,12	400	0,42	1400
F100215	F100271	F100226	63A4	0,13	0,18	400	0,48	1400
F100004	F100006	F100008	63B4	0,18	0,25	400	0,67	1400
F100046	F100073	F100041	71A4	0,26	0,35	400	0,79	1400
F100007	F100002	F100109	71B4	0,37	0,50	400	1,10	1400
F100056	F100076	F100108	80A4	0,55	0,75	400	1,53	1400
F100010	F100083	F100027	80B4	0,75	1,00	400	1,98	1400
F100063	F100057	F100110	90S4	1,10	1,50	400	2,79	1400
F100001	F100118	F100232	90L4	1,50	2,00	400	3,65	1400
F100058	F100234	F100272	100A4	2,20	3,00	400	4,78	1400
F100034	F100237	F100273	100B4	3,00	4,00	400	6,52	1400
F100313	F100314	F100321	*112A4	4,00	5,50	400	8,38	1400
F100315	F100316	F100322	*132S4	5,50	7,50	400	11,10	1400
F100317	F100318	F100320	*132L4	7,50	10,00	400	14,60	1400

**6 Poli / Poles / Pole / Poles / Polos 900 rpm**

Nostro codice Our code Unsere kode Notre code Nuestro codigo			Tipo Type Typ Type Tipo	Potenza Power Leistung Puissance Potencia	Potenza Power Leistung Puissance Potencia	Tensione Voltage Spannung Tension Voltaje	Corrente Current Stromstärke Courant Corriente	Velocità Speed Drehzahl Vitesse Velocidad
B5	B3	B14		KW	hp	V	A (400V)	rpm
			63A6	-	-	-	-	-
			63B6	-	-	-	-	-
F100092	F100095	F100340	71A6	0,18	0,25	400	0,82	900
F100102	F100154	F100126	71B6	0,26	0,35	400	1,05	900
F100096	F100080	F100341	80A6	0,37	0,50	400	1,22	900
F100082	F100218	F100133	80B6	0,55	0,75	400	1,90	900
F100189	F100254	F100290	90S6	0,75	1,00	400	2,10	900
F100114	F100255	F100291	90L6	1,10	1,50	400	2,90	900
F100145	F100279	F100292	100A6	1,50	2,00	400	3,60	900
F100293	F100256	F100294	100B6	2,20	3,00	400	4,90	900
F100295	F100257	F100296	112A6	3,00	4,00	400	6,70	900
F100327	F100328	F100329	*132S6	4,00	5,50	400	8,70	900
F100330	F100331	F100332	*132L6	5,50	7,50	400	11,60	900



**Motori asincroni trifase** (Prodotto escluso dal campo di applicazione del Sistema Qualità ISO 9001)

**Asynchronous three-phase motors** (This product is excluded from the scope of ISO 9001 Quality Management System)

**Asynchron-drehstrommotoren** (Dieses Produkt ist vom Anwendungsbereich des Qualitätsmanagementsystems ISO 9001 ausgeschlossen)

**Moteurs asynchrones triphases** (Ce produit est exclu du domaine d'application du Système de Gestion de la Qualité ISO 9001)

**Motores asincronos trifasicos** (Esto producto está excluido del campo de aplicación del Sistema de Gestión de la Calidad ISO 9001)



**V 230/400 50 Hz ± 10% V \* V. 400/690 50 Hz**

Rendimento Efficiency Wirkungsgrad Rendimento Eficiencia %	Momento di inerzia Moment of inertia Trägheitsmoment Momento di inerzia Momento de inerzia J (Kgm)	Coppia nominale Rated torque Nenn Drehmoment Couple nominal Torque de régime Cn (Nm)	Peso Weight Gewicht Poids Peso Kg (B3)	Peso Weight Gewicht Poids Peso Kg (B5)	Peso Weight Gewicht Poids Peso Kg (B14)
60,0	0,00095	0,30	3,8	4,0	3,8
66,0	0,00140	0,44	4,0	4,2	4,0
70,0	0,00140	0,61	4,0	4,2	4,0
72,0	0,00180	0,86	4,6	4,9	4,6
72,5	0,000320	1,25	5,6	6,0	5,6
74,5	0,000400	1,90	6,2	7,0	6,2
76,0	0,000700	2,55	9,0	9,5	9,0
77,0	0,000900	3,25	10,0	10,5	10,0
78,5	0,001200	5,10	12,0	12,5	12,0
79,0	0,001500	7,40	13,2	13,6	13,2
82,0	0,002900	10,10	22,0	22,5	22,0
85,0	0,005500	13,30	29,0	29,5	29,0
85,5	0,011000	18,30	41,0	42,0	41,0
86,0	0,013000	24,90	46,0	47,0	46,0

**V 230/400 50 Hz ± 10% V \* V. 400/690 50 Hz**

Rendimento Efficiency Wirkungsgrad Rendimento Eficiencia %	Momento di inerzia Moment of inertia Trägheitsmoment Momento di inerzia Momento de inerzia J (Kgm)	Coppia nominale Rated torque Nenn Drehmoment Couple nominal Torque de régime Cn (Nm)	Peso Weight Gewicht Poids Peso Kg (B3)	Peso Weight Gewicht Poids Peso Kg (B5)	Peso Weight Gewicht Poids Peso Kg (B14)
56,0	0,00014	0,61	3,8	4,0	3,8
60,0	0,00024	0,89	4,0	4,3	4,0
62,0	0,00031	1,23	4,5	4,9	4,5
67,0	0,00057	1,71	5,6	6,0	5,6
69,0	0,00070	2,50	6,2	7,0	6,2
72,0	0,00120	3,80	9,0	9,5	9,0
74,0	0,00150	5,10	10,0	10,5	10,0
75,0	0,00190	7,50	12,0	12,5	12,0
76,0	0,00230	10,20	13,2	13,6	13,2
81,0	0,00550	14,80	21,0	21,5	21,0
82,0	0,00630	20,20	25,0	25,5	25,0
84,0	0,01000	26,50	29,0	29,5	29,0
85,5	0,02200	36,50	44,0	45,0	44,0
87,0	0,02800	49,70	54,0	55,0	54,0

**V 230/400 50 Hz ± 10% V \* V. 400/690 50 Hz**

Rendimento Efficiency Wirkungsgrad Rendimento Eficiencia %	Momento di inerzia Moment of inertia Trägheitsmoment Momento di inerzia Momento de inerzia J (Kgm)	Coppia nominale Rated torque Nenn Drehmoment Couple nominal Torque de régime Cn (Nm)	Peso Weight Gewicht Poids Peso Kg (B3)	Peso Weight Gewicht Poids Peso Kg (B5)	Peso Weight Gewicht Poids Peso Kg (B14)
-	-	-	-	-	-
-	-	-	-	-	-
60,0	0,0010	1,64	6,6	7,2	6,6
64,0	0,0012	2,28	7,0	7,8	7,0
69,0	0,0012	3,77	10,0	10,8	10,0
66,0	0,0023	5,63	11,0	12,0	11,0
73,0	0,0037	7,80	14,0	15,0	14,0
74,0	0,0045	11,80	15,3	16,5	15,3
78,0	0,0070	15,90	20,3	21,5	20,3
81,0	0,0090	19,10	27,5	29,0	27,5
84,0	0,0130	23,40	40,0	42,0	40,0
84,0	0,0300	31,80	53,0	55,0	53,0
86,0	0,0400	42,50	54,0	56,0	54,0

**Dimensioni  
d'ingombro**
**Dimensions**
**Abmessungen**
**Encombremets**
**Dimensiones**
**B3**

Tipo / Type Typ / Type Tido	A	A/2	B	C	D	F	E	H	K	L	AB	AC	HD	Z	Z1
56	90	45,0	71	36	9	3	20	56	5,8	187	112	108	149	90	112
63	100	50,0	80	40	11	4	23	63	7,0	215	120	120	155	100	120
71	112	56,0	90	45	14	5	30	71	7,0	245	135	140	175	112	135
80	125	62,5	100	50	19	6	40	80	10,0	290	155	155	230	122	155
90 S	140	70,0	100	56	24	8	50	90	10,0	305	175	170	250	153	175
90 L	140	70,0	125	56	24	8	50	90	10,0	335	175	170	250	153	175
100	160	80,0	140	63	28	8	60	100	12,0	390	200	200	257	185	200
112	190	95,0	140	70	28	8	60	112	12,0	395	225	215	275	185	225
132 S	215	95,0	140	89	38	10	80	132	12,0	465	265	265	315	210	265

**B5**

Tipo / Type / Typ / Type / Tido	P	N	LA	G	R	T	Y	I	M	O	S	U
56	120	80	100	7,0	9	3,0	93	3	14	10,2	M4	10
63	140	95	115	10,0	10	3,0	97	4	14	12,5	M4	10
71	160	110	130	10,0	10	3,5	104	5	20	16,0	M5	13
80	200	130	165	12,0	10	3,5	113	6	30	21,5	M6	16
90S/L	200	130	165	12,0	11	3,5	123	7	40	27,0	M8	20
100	250	180	215	14,5	11	4,0	157	7	45	31,0	M10	24
112	250	180	215	14,5	11	4,0	163	7	45	31,0	M10	25
132S/L	300	230	265	14,5	15	4,0	183	8	60	41,0	M12	30

**B14**

Tipo / Type / Typ / Type / Tido	P	N	LA	G1	T
56	80	50	65	M5	2,0
63	90	60	75	M5	2,0
71	105	70	85	M6	2,5
80	120	80	100	M6	3,0
90S/L	140	95	115	M8	3,0
100	160	110	130	M8	3,5
112	160	110	130	M8	3,5

**Motori asincroni trifase** (Prodotto escluso dal campo di applicazione del Sistema Qualità ISO 9001)

**Asynchronous three-phase motors** (This product is excluded from the scope of ISO 9001 Quality Management System)

**Asynchron-drehstrommotoren** (Dieses Produkt ist vom Anwendungsbereich des Qualitätsmanagementsystems ISO 9001 ausgeschlossen)

**Moteurs asynchrones triphases** (Ce produit est exclu du domaine d'application du Système de Gestion de la Qualité ISO 9001)

**Motores asincronos trifasicos** (Esto producto está excluido del campo de aplicación del Sistema de Gestión de la Calidad ISO 9001)

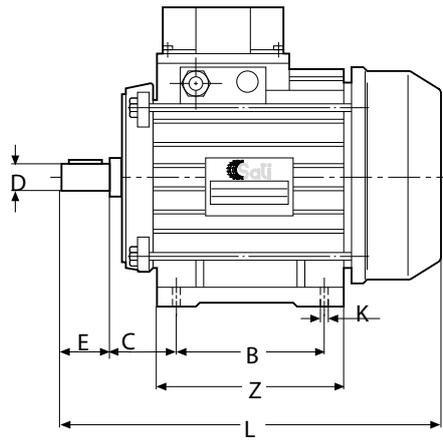
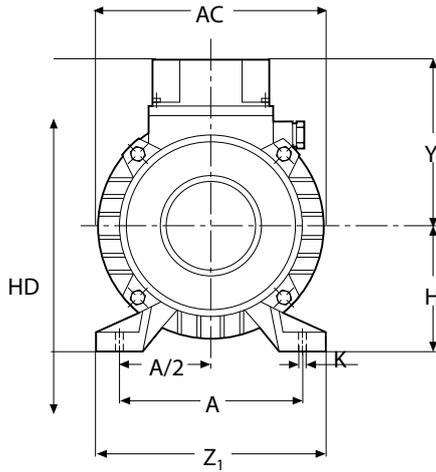
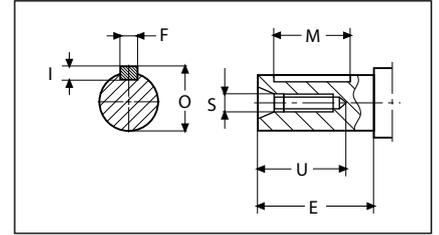

**B3**

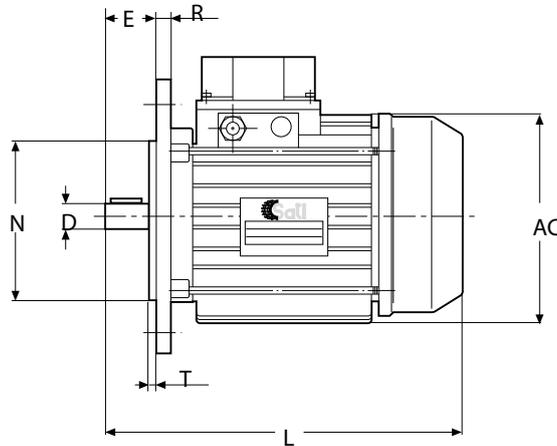
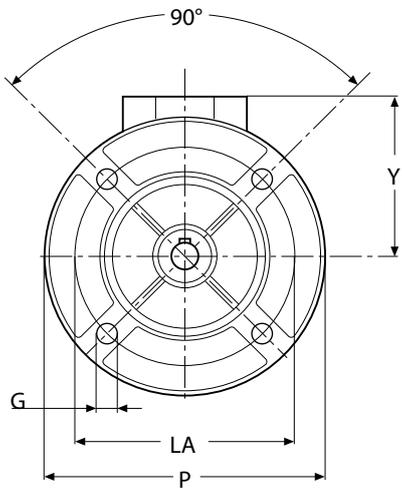

**B5**

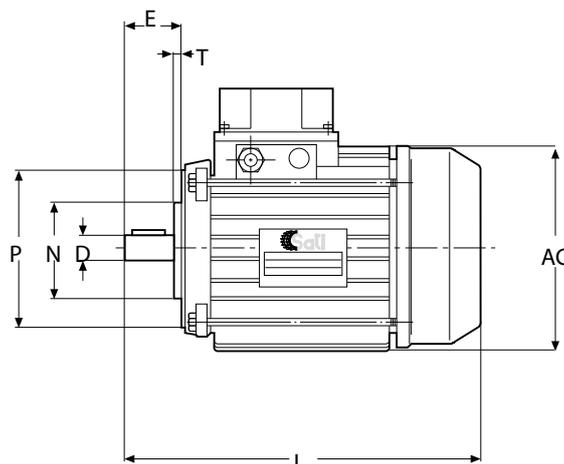
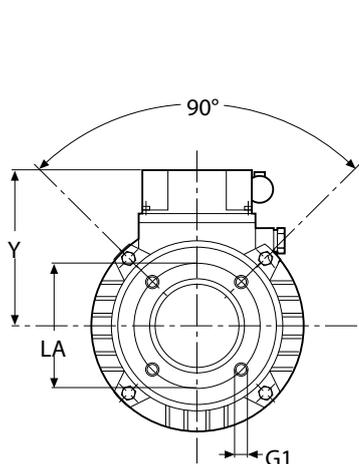

**B14**

## Caratteristiche tecniche

I motori elettrici proposti dalla Sati sono costruiti secondo le dimensioni delle norme internazionali: flange, alberi e fissaggio a piedi sono dimensionati secondo le dimensioni richiamate dalla normativa IEC 72-1 e IEC 34-7.

La costruzione dei motori è chiusa, ventilata esternamente e con rotore a gabbia equilibrato dinamicamente. La tensione nominale dei motori Sati (V. 230/400 - 50 Hz) ammette una variazione  $\pm 10\%$  rendendo, gli stessi, adatti alle seguenti tensioni di alimentazione:

Tipo	220/380 - 50Hz	240/415 - 50Hz	260/440 - 60Hz	280/480 - 60Hz	400/690 - 50Hz
56	●	●	●	●	
63	●	●	●	●	
71	●	●	●	●	
80	●	●	●	●	
90	●	●	●	●	
100	●	●	●	●	
112					●
132					●

Le caratteristiche di protezione e funzionamento sono le seguenti:

Protezione: IP 55

Isolamento: classe F

Servizio: S 1

Le macchine sono costruite con materiali di sicura qualità; in particolare, la carcassa è in alluminio pressofuso, gli alberi in acciaio C 40, la copriventola in lamiera stampata e fissata con viti al corpo carcassa, rotore in alluminio e statore isolato con materiali idonei alla classificazione "F".

## Protezione

I tipi di protezione indicati dalla norma (CEI EN 60529 - IEC 34/5) sono identificati dalla sigla "IP" seguita da due cifre che determinano le caratteristiche della protezione stessa: la prima sta ad indicare la protezione contro la penetrazione di materie estranee o contatti accidentali e la seconda contro l'acqua.

### Prima cifra:

- 0 Nessuna protezione
- 1 Contro penetrazione di corpi di grandi dimensioni
- 2 Contro penetrazione di corpi di medie dimensioni
- 3 Contro penetrazione di corpi di piccole dimensioni
- 4 Contro penetrazione di corpi di minuscole dimensioni
- 5 Contro depositi interni di polvere
- 6 Protezione totale da depositi interni di polvere

### Seconda cifra:

- 0 Nessuna protezione
- 1 Contro penetrazione verticale di gocce d'acqua
- 2 Contro penetrazione inclinata di gocce d'acqua
- 3 Contro spruzzi fini d'acqua
- 4 Contro spruzzi d'acqua
- 5 Contro getti d'acqua
- 6 Contro l'innondazione
- 7 Contro l'immersione
- 8 Contro la sommersione

## Servizio

Quando il carico è costante o varia con criteri conosciuti, si può rappresentare con valori numerici o con grafici indicanti la variazione del carico al passare del tempo. In caso contrario, la tabella di seguito riportata detta alcuni parametri dei servizi di lavoro.

**S1** Funzionamento a carico costante e di durata sufficiente al raggiungimento dell'equilibrio termico (**servizio continuo**).

**S2** Funzionamento a carico costante per un periodo di tempo inferiore a quanto sopra, seguito da un periodo di riposo sufficiente a ristabilire tra temperatura della macchina e quello del fluido, l'uguaglianza con una tolleranza di 2° (**servizio di durata limitata**).

**S3** Sequenza di cicli identici di funzionamento, ciascuno comprendente fasi di riposo e di lavoro a carico costante (**servizio intermittente periodico**).

**S4** Sequenza di cicli identici di funzionamento, ciascuno comprendente fasi trascurabili di avviamento. Un periodo di lavoro a carico costante ed un periodo di riposo; in questo caso è consigliabile indicare il n° di inserzioni/h (**Servizio periodico con avviamento**).

**S5** Come S4, ma con frenata rapida (**servizio periodico con frenata**).

**S6** Sequenza di cicli identici di funzionamento, ciascuno comprendente un periodo di carico costante ed un periodo di funzionamento a vuoto senza alcun periodo di riposo (**servizio ininterrotto periodico con carico intermittente**).

**S7** Sequenza di cicli di funzionamento come S5, ma senza periodi di riposo (**servizio ininterrotto periodico con frenata**).

**S8** Sequenza di cicli identici di funzionamento, ciascuno comprendente un periodo di carico costante ad una velocità prestabilita, seguito da cicli a carico costante ma a velocità diverse, senza periodo di riposo (**servizio ininterrotto periodico con variazioni correlate di carico e velocità**).

**S9** Carico e velocità variano in modo non periodico compreso frequenti sovraccarichi, superiori al valore a pieno carico (**servizio con variazioni, non periodiche, di carico e velocità**).

## Caratteristiche elettriche generali

**Tensione nominale:** è la tensione che normalmente si ha nei morsetti di alimentazione

**Potenza nominale:** è la potenza sviluppata, all'albero

**Coppia nominale:** è il fattore risultante dalla potenza nominale ed i giri nominali

**Coppia massima:** è la coppia che si ottiene dal motore alimentato a tensione e frequenza nominali.

### Temperature di funzionamento:

classe di isolamento	temperatura limite di esercizio
A	105°C
E	120°C
B	130°C
F	155°C
H	180°C

### Attenzione

La temperatura indicata in tabella, è comprensiva della temperatura ambiente (es. se si ha una temperatura nell'area di lavoro di 30 ° C, un motore con isolamento H può funzionare con temperatura propria di 150°C).

(Prodotto escluso dal campo di applicazione del Sistema Qualità ISO 9001)  
 (This product is excluded from the scope of ISO 9001 Quality Management System)  
 (Dieses Produkt ist vom Anwendungsbereich des Qualitätsmanagementsystems ISO 9001 ausgeschlossen)  
 (Ce produit est exclu du domaine d'application du Système de Gestion de la Qualité ISO 9001)  
 (Esto producto está excluido del campo de aplicación del Sistema de Gestión de la Calidad ISO 9001)



## Technical specifications

Sati's electric motors are manufactured to international standards regarding dimensions: flanges, shafts and attachments to the base are of a size which conform to the dimensions required by regulations IEC 72-1 and IEC 34-7.

The motor housing is sealed, and ventilated externally and with a shielded and dynamically balanced rotor. The nominal voltage of motors Sati (230/400 V - 50 Hz) can function with a variation of  $\pm 10\%$  V and this renders the motors suitable for the following power supplies:

Type / Typ	220/380 - 50Hz	240/415 - 50Hz	260/440 - 60Hz	280/480 - 60Hz	400/690 - 50Hz
56	●	●	●	●	
63	●	●	●	●	
71	●	●	●	●	
80	●	●	●	●	
90	●	●	●	●	
100	●	●	●	●	
112					●
132					●

The specifications regarding protection and operation are as follows:

Protection: IP 55  
 Insulation: class F  
 Service: S 1

The motors are built from high-quality materials; in particular, the casing is in pressure-cast aluminium, the shafts in C 40 steel, the fan cover is in stamped sheet metal and fixed with screws to the casing, the rotor is made from aluminium and the stator is insulated with materials conforming to "F" classification.

## Protection

The types of protection conforming to regulations (EN 60529 - IEC 34/5) are identified by the mark "IP" followed by two numbers which lay down the specifications of the actual protection: the first represents the degree of protection against penetration of extraneous material or accidental contacts and the second against penetration of water.

### First number:

- 0 No protection
- 1 Against penetration by large objects
- 2 Against penetration by medium-sized objects
- 3 Against penetration by small objects
- 4 Against penetration by tiny objects
- 5 Against internal deposits of dust
- 6 Total protection from internal deposits of dust

### Second number:

- 0 No protection
- 1 Against vertical penetration of drops of water
- 2 Against inclined penetration of drops of water
- 3 Against fine water spray
- 4 Against water spray
- 5 Against jets of water
- 6 Against floods
- 7 Against immersion
- 8 Against submersion

## Operative use

When the load is constant or varies by known criteria, the use made of the unit can be shown in number or graph form. If this is not the case, the table below provides some parameters for operative use.

**S1** Operation under constant load and for a sufficient duration for thermal equilibrium to be reached (**continuous operation**)

**S2** Operation under constant load for less time than above, followed by a rest phase sufficient to re-establish a balance between the temperature of the machine and that of fluid within a tolerance of 2° (**operation for a limited period of time**)

**S3** A series of identical work cycles, each including rest phases and constant load work phases (**periodic intermittent operation**).

**S4** A series of identical work cycles, each including negligible start-up phases, a work phase under constant load and a rest; in this case, it is advisable to indicate the number of start-ups per hour (**periodic operation with start-up**).

**S5** As per S4 but with rapid electrical braking (**periodic operation with braking**).

**S6** A sequence of identical work cycles, each including a period of constant load and a period of idling but without any rest phases (**uninterrupted periodic operation with intermittent load**).

**S7** Sequence of cycles as per S5 but without any rest phases (**uninterrupted periodic operation with braking**).

**S8** A sequence of identical work cycles, each including a period of constant load at a certain pre-established velocity, followed by constant load period but at different velocities, without any rest phase (**uninterrupted periodic operation with correlated variations of load and velocity**).

**S9** Load and velocity vary in a non-periodic manner and include frequent overloads which are greater than the value at full load (**operation with non-periodic variations of load and velocity**).

## General electrical specifications

**Nominal voltage:** this is the voltage which is normally available from power supply terminals.

**Nominal power:** this is the power generated at the shaft.

**Rated torque:** this is the factor derived from the nominal power and the nominal revolutions.

**Maximum torque:** this is the torque obtained from the motor operating with nominal voltage and frequency.

### Operating temperatures:

insulation category	upper temperature operating limit
A	105°C
E	120°C
B	130°C
F	155°C
H	180°C

### Important note

The temperature shown in the table includes the ambient temperature (eg, if the temperature in the work area is 30°C, a motor with insulation category H can safely operate with a working temperature of its own of 150°C).

## Technische eigenschaften

Sati Elektromotoren sind gemäß den Abmessungen der internationalen Normen hergestellt: Flansche, Wellen und Fußbefestigungen sind entsprechend den in den Normen IEC 72-1 und IEC 34-7 geforderten Abmessungen ausgelegt.

Die Motoren sind in geschlossener Bauart ausgeführt, außenbelüftet und mit einem dynamisch ausgewuchteten Käfigläufer versehen.

Die Nennspannung der Sati Motoren (230/400V-50Hz) läßt eine Schwankung von 10% zu, wodurch sie für die folgenden Versorgungsspannungen geeignet sind:

Die Schutz- und Betriebsmerkmale sind wie folgt definiert:

Schutz: IP 55  
 Isolierung: Klasse F  
 Betrieb: S 1

Die Motoren sind aus reinen Qualitätswerkstoffen hergestellt; insbesondere sind das Gehäuse aus druckgegossenem Aluminium, die Wellen aus C40-Stahl, der Lüfterraddeckel aus formgestanztem Blech und mit Schrauben an dem Gehäusekörper befestigt, der Läufer aus Aluminium und der Stator mit Materialien isoliert, die der Klasse "F" entsprechen.

## Schutzart

Die in der Norm (EN 60529 - IEC 34/5) angegebenen Schutzarten werden durch die Bezeichnung "IP" gekennzeichnet, gefolgt von zwei Ziffern, welche die Schutzmerkmale selbst bestimmen: Die erste Ziffer dient zur Angabe des Schutzes gegen das Eindringen von Fremdstoffen oder gegen zufällige Kontakte, und die zweite Ziffer gegen das Eindringen von Wasser.

### Erste Ziffer

- 0 Kein Schutz
- 1 Gegen Eindringen von großvolumigen Körpern
- 2 Gegen Eindringen von mittelvolumigen Körpern
- 3 Gegen Eindringen von kleinvolumigen Körpern
- 4 Gegen Eindringen von kleinstvolumigen Körpern
- 5 Gegen interne Staubablagerungen
- 6 Vollständiger Schutz gegen interne Staubablagerungen

### Zweite Ziffer

- 0 Kein Schutz
- 1 Gegen vertikales Eindringen von Wassertropfen
- 2 Gegen schräges Eindringen von Wassertropfen
- 3 Gegen feine Wasserspritzer
- 4 Gegen Wasserspritzer
- 5 Gegen Wasserstrahlen
- 6 Gegen Überfluten
- 7 Gegen Eintauchen
- 8 Gegen Untertauchen

## Betriebsart

Wenn die Last konstant ist oder unter bekannten Bedingungen variiert, kann man für den Betrieb die Lastvariation mit numerischen oder grafischen Werten in Abhängigkeit von der Zeit darstellen. Im entgegengesetzten Fall gibt die folgend aufgeführte Tabelle einige Betriebsparameter an.

**S1** Betrieb bei konstanter Last und ausreichender Dauer zum Erreichen des thermischen Gleichgewichts. (**Kontinuierlicher Betrieb**)

**S2** Betrieb bei konstanter Last für eine in Bezug auf S1 geringere Zeitperiode, gefolgt von einer Ruheperiode, die ausreichend ist zur Wiederherstellung der Gleichheit zwischen Gerät- und Mediumtemperatur mit einer Toleranz von 2°. (**Begrenzte Betriebsdauer**)

**S3** Folge identischer Betriebszyklen, wobei jeder Ruhephasen und Arbeitsphasen bei konstanter Last aufweist. (**Periodischer Intermittierbetrieb**)

**S4** Folge identischer Betriebszyklen, wobei jeder vernachlässigbare Anlaufphasen, eine Arbeitsperiode unter konstanter Last und eine Ruheperiode aufweist. In diesem Fall ist es ratsam, die Einschalthäufigkeit/h anzugeben. (**Periodischer Betrieb mit Anlauf**)

**S5** Wie S4, jedoch mit elektrischer Schnellbremsung. (**Periodischer Betrieb mit Bremsung**)

**S6** Folge identischer Betriebszyklen, wobei jeder eine konstante Lastperiode und eine Leerlaufperiode ohne jegliche Ruheperiode aufweist. (**Periodischer Dauerbetrieb mit Aussetzender Last**)

**S7** Betriebszyklenfolge wie S5, jedoch ohne Ruheperioden. (**Periodischer Dauerbetrieb mit Bremsung**)

**S8** Folge identischer Betriebszyklen, wobei jeder eine konstante Lastperiode bei einer vorbestimmten Drehzahl aufweist, gefolgt von Perioden mit konstanter Last, jedoch bei unterschiedlichen Drehzahlen, ohne Ruheperiode. (**Periodischer Dauerbetrieb mit Kombinierten Last- und Drehzahlschwankungen**)

**S9** Last und Geschwindigkeit verändern sich in nicht periodischer Weise, einschließlich häufige Überbelastungen, die größer als der Wert bei voller Last sind. (**Betrieb Mit Nicht Periodischen Last- und Drehzahlschwankungen**)

## Allgemeine Elektrische Eigenschaften

**Nennspannung:** Ist die Spannung, die normalerweise in den Eingangsklemmen vorliegt.

**Nennleistung:** Ist die an der Welle erzeugte Leistung.

**Nenn Drehmoment:** Ist der sich aus der Nennleistung und den Nenn Drehzahlen ergebende Faktor.

**Maximales Drehmoment:** Ist das Drehmoment, welches man bei einem mit Nennspannung und Nennfrequenz versorgten Motor erhält.

### Betriebstemperaturen:

Isolierungsklasse	Betriebsgrenztemperatur
A	105°C
E	120°C
B	130°C
F	155°C
H	180°C

### Achtung

Die in der Tabelle angegebene Temperatur schließt die Umgebungstemperatur mit ein. (Beispiel: Wenn eine Arbeitsraumtemperatur von 30°C vorliegt, kann ein Motor mit Isolierung H bei einer Eigentemperatur von 150°C betrieben werden).

### Caracteristiques techniques

Les moteurs électriques proposés par la Société Sati sont construits conformément aux dimensions prévues par les normes internationales: flasques, arbres et fixation à pieds possèdent des mesures conformes à celles reprises par les normes IEC 72.1 et IEC 34.7.

La carcasse des moteurs est fermée, ventilée à l'extérieur avec un rotor à cage dynamiquement équilibré.

La tension nominale des moteurs Sati (230/400 V - 50 Hz) admet une variation de  $\pm 10\%$ , d'où la possibilité, pour ces moteurs, de s'adapter aux tensions d'alimentation suivantes:

Type/Tipo	220/380 - 50Hz	240/415 - 50Hz	260/440 - 60Hz	280/480 - 60Hz	400/690 - 50Hz
56	●	●	●	●	
63	●	●	●	●	
71	●	●	●	●	
80	●	●	●	●	
90	●	●	●	●	
100	●	●	●	●	
112					●
132					●

Les caractéristiques de protection et de fonctionnement sont les suivantes:

Protection: IP 55  
 Isolation: classe F  
 Service: S 1

Les moteurs sont construits avec des matériaux qualitativement fiables; la carcasse, en particulier, est en aluminium moulé sous pression, les arbres sont en acier C 40, le couvre-ventilateur est en tôle moulée et fixée par des vis au corps de la carcasse, le rotor est en aluminium et le stator est isolé par des matériaux convenant à la classification "F".

### Protection

Les types de protection indiqués par la norme (EN 60529 - IEC 34/5) sont identifiés par le sigle "IP" suivi de deux chiffres qui déterminent les caractéristiques de la protection proprement dite: le premier indique la protection contre la pénétration de corps étrangers ou contre les contacts accidentels, tandis que le deuxième indique la protection contre l'eau.

#### Premier chiffre

- 0 Aucune protection
- 1 Contre pénétration de corps de grandes dimens.
- 2 Contre pénétration de corps de moyennes dim.
- 3 Contre pénétration de corps de petites dimens.
- 4 Contre pénétration de corps de dim. minuscules
- 5 Contre dépôts internes de poussière
- 6 Protect. tot. contre les dépôts internes de poussière

#### Deuxième chiffre

- 0 Aucune protection
- 1 Contre pénétration vert. de gouttes d'eau
- 2 Contre pénétr. inclinée de gouttes d'eau
- 3 Contre les giclées fines d'eau
- 4 Contre les giclées d'eau
- 5 Contre les jets d'eau
- 6 Contre l'inondation
- 7 Contre l'immersion
- 8 Contre la submersion

### Service

Lorsque la charge est constante ou encore si elle varie avec des critères connus, le service peut être représenté par des valeurs numériques ou par des graphiques qui indiquent la variation de la charge au fil du temps; dans le cas contraire le tableau suivant dicte quelques paramètres des services de travail.

- S1** Fonctionnement à charge constante et d'une durée suffisante pour l'obtention de l'équilibre thermique (**service continu**).
- S2** Fonctionnement à charge constante pendant une période de temps inférieure aux indications qui précèdent, suivie d'une période de repos suffisante pour rétablir l'égalité entre la température de la machine et celle du fluide, avec une tolérance de 2° (**service d'une durée limitée**).
- S3** Séquence de cycles identiques de fonctionnement; chaque cycle comprend des phases de repos et de travail à charge constante (**service intermittent périodique**).
- S4** Séquence de cycles identiques de fonctionnement, chaque cycle comprenant des phases négligeables de démarrage, une période de travail à charge constante et une période de repos; nous conseillons, dans ce cas, d'indiquer le nombre de démarrages/h (**service périodique avec démarrage**).
- S5** Comme S4, mais avec freinage électrique rapide (**service périodique avec freinage**).
- S6** Séquence de cycles identiques de fonctionnement, comprenant chacun une période de charge constante et une période de fonctionnement à vide sans aucune période de repos (**service ininterrompu périodique avec charge intermittente**).
- S7** Séquence de cycles de fonctionnement comme S5, mais sans périodes de repos (**service ininterrompu périodique avec freinage**).
- S8** Séquence de cycles identiques de fonctionnement, comprenant chacun une période de charge constante à une certaine vitesse préfixée, suivie de périodes à charge constante, mais à des vitesses différentes, sans période de repos (**service ininterrompu périodique avec variations en corrélation avec la charge et la vitesse**).
- S9** La charge et les vitesses varient de manière non périodique, y compris les surcharges fréquentes, supérieures à la valeur à pleine charge (**service avec variations, non périodiques, de charge et de vitesse**).

### Caractéristiques électriques générales

**Tension nominale:** tension que l'on a normalement dans les bornes d'alimentation.

**Puissance nominale:** puissance développée, à l'arbre.

**Couple nominal:** facteur qui résulte de la puissance nominale et des tours nominaux.

**Couple maximal:** couple que l'on obtient du moteur alimenté à une tension et à une fréquence nominales.

#### Températures de fonctionnement:

classe d'isolation	température-limite d'exercice
A	105°C
E	120°C
B	130°C
F	155°C
H	180°C

#### Attention:

La température indiquée sur le tableau englobe la température ambiante (par ex.: si l'on a une température de 30° C dans la zone de travail, un moteur avec isolation H peut fonctionner avec sa propre température de 150° C).

### Características técnicas

Los motores eléctricos propuestos por Sati están fabricados según las normas internacionales: bridas, ejes y fijaciones de los pies tienen las dimensiones establecidas por las normas IEC 72-1 y IEC 34-7.

La estructura de los motores es cerrada y está ventilada exteriormente mientras que el rotor de jaula está equilibrado dinámicamente.

La tensión nominal de los motores Sati (230/400 - 50 Hz) admite una tolerancia de  $\pm 10\%$ , permitiendo su empleo con las siguientes tensiones de alimentación:

Las características de protección y funcionamiento son las siguientes:

Protección: IP 55  
 Aislamiento: clase F  
 Servicio: S 1

Los motores están fabricados con material de primera calidad. La carcasa es de aluminio vaciado a presión, los ejes son de acero C40, el cubreventilador es de chapa estampada y está atornillado a la carcasa, el rotor es de aluminio y el estator está aislado con material adecuado a la clase F.

### Protección

Los tipos de protección definidos por la norma (EN 60529 - IEC 34/5) se identifican con la sigla "IP" seguida por dos cifras: la primera indica la protección contra penetración de material extraño o contactos accidentales, la segunda la protección contra el agua.

#### Primera cifra

- 0 Ninguna protección
- 1 Contra penetración de cuerpos de dimensiones grandes
- 2 Contra penetración de cuerpos de dimensiones medias
- 3 Contra penetración de cuerpos de dimensiones pequeñas
- 4 Contra penetración de cuerpos de dimensiones minúsculas
- 5 Contra depósitos interiores de polvo
- 6 Protección total contra depósitos interiores de polvo

#### Segunda cifra

- 0 Ninguna protección
- 1 Contra penetración vertical de gotas de agua
- 2 Contra penetración inclinada de gotas de agua
- 3 Contra salpicaduras finas de agua
- 4 Contra salpicaduras de agua
- 5 Contra chorros de agua
- 6 Contra inundación
- 7 Contra inmersión
- 8 Contra sumersión

### Servicio

Si la carga es constante o varía según criterios conocidos, el servicio puede representarse mediante tablas de valores numéricos o gráficos que describen la variación de la carga en función del tiempo. En caso contrario, el servicio se describe según los parámetros que se presentan en la siguiente tabla.

- S1** Funcionamiento con carga constante hasta alcanzar el equilibrio térmico (**servicio continuo**).
- S2** Funcionamiento con carga constante durante un tiempo inferior al anterior seguido por un período de reposo hasta el restablecimiento del equilibrio térmico entre la máquina y el fluido con una tolerancia de 2 °C (**servicio de duración limitada**).
- S3** Secuencia de ciclos de funcionamiento idénticos. Cada ciclo consiste en una fase de reposo y otra de trabajo con carga constante (**servicio intermitente periódico**).
- S4** Secuencia de ciclos de funcionamiento idénticos. Cada ciclo consiste en una fase de arranque despreciable, un período de trabajo con carga constante y un período de reposo. En este caso es aconsejable indicar el número de arranques por hora (**servicio periódico con puesta en marcha**).
- S5** Como en S4 pero con frenado eléctrico rápido (**servicio periódico con frenado**).
- S6** Secuencia de ciclos de funcionamiento idénticos. Cada ciclo consiste en un período de carga constante y uno de funcionamiento en vacío sin períodos de reposo (**servicio ininterrompido periódico con carga intermitente**).
- S7** Secuencia de ciclos de funcionamiento como en S5 pero sin períodos de reposo (**servicio ininterrompido periódico con frenado**).
- S8** Secuencia de ciclos de funcionamiento idénticos. Cada ciclo consiste en un período de carga constante a velocidad preestablecida seguido por períodos de carga constante a diferentes velocidades sin período de reposo (**servicio ininterrompido periódico con variaciones de carga y velocidad**).
- S9** La carga y la velocidad varían de modo no periódico y se producen frecuentes sobrecargas cuyo valor supera el de funcionamiento a plena carga (**servicio con variaciones no periódicas de carga y velocidad**).

### Características eléctricas generales

**Tensión nominal:** es la tensión normal en los bornes de alimentación.

**Potencia nominal:** es la potencia desarrollada en el eje.

**Par nominal:** es el factor resultante de la potencia y la velocidad nominales.

**Par máximo:** es el par que se obtiene cuando el motor es alimentado con tensión y frecuencia nominales.

#### Temperaturas de funcionamiento:

clase de aislamiento	temperatura límite de trabajo
A	105°C
E	120°C
B	130°C
F	155°C
H	180°C

#### Atención

Las temperaturas indicadas en la tabla incluyen la temperatura ambiente (por ejemplo, un motor con aislamiento H a una temperatura ambiente de 30 °C puede funcionar con temperatura propia de 150 °C).

**Motori asincroni trifase**

**Three-phase asynchronous motors**

**Asynchron-drehstrommotoren**

**Moteurs asynchrones triphases**

**Motores asíncronos trifásicos**

**220 Volt**

**Collegamento triangolo / Triangle connection**  
**Dreieckschaltung / Couplage triangle / Conexión triángulo**

**380 Volt**

**Collegamento stella / Star connection**  
**Sterneinschaltung / Couplage étoile / Conexión estrella**

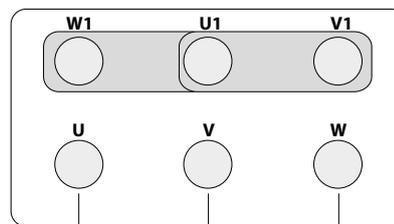
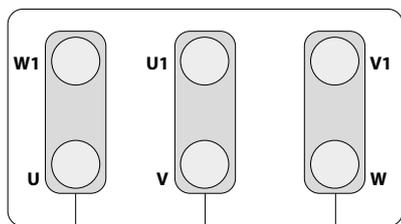

- 1 R S T
- 2 S R T

- 1 R S T
- 2 S R T

1 Rotazione oraria	Clockwise rotation	Drehung im Uhrzeigersinn	Rotation dans le sens des aiguilles d'une montre	Rotación horaria
2 Rotazione antioraria	Anti-clockwise rotation	Drehung gegen den Uhrzeigersinn	Rotation contraire a celle des aiguilles d'une montre	Rotación antihoraria

**Motori monofase**

**Monophase motors**

**Einphasenmotoren**

**Moteurs monophasés**

**Motores monofase**

**Rotazione antioraria / Anti-clockwise rotation**  
**Drehung gegen den Uhrzeigersinn**  
**Rotation contraire a celle des aiguilles d'une montre**  
**Rotación antihoraria**

**Rotazione oraria / Clockwise rotation / Drehung im Uhrzeigersinn**  
**Rotation dans le sens des aiguilles d'une montre / Rotación horaria**

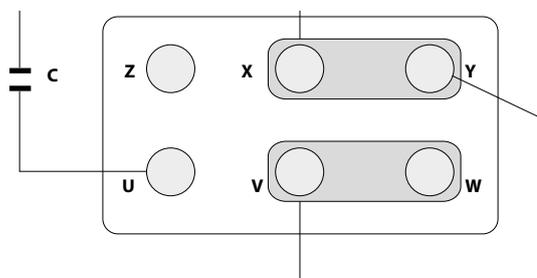
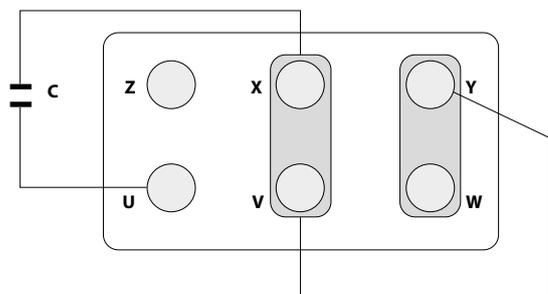

**Linea/Grid/Leitung/Ligne/Línea**

**Linea/Grid/Leitung/Ligne/Línea**

**Avviamento con collegamento diretto**

È il metodo più semplice e corrente per motori di piccola-media potenza, collegando direttamente i morsetti dell'avvolgimento alla linea.

**Starting up with direct connection**

This is the simplest and most common method for low to medium-power motors, executed by connecting the clips from the winding directly to the power source.

**Direkteinschaltung**

Es ist die einfachste und üblichste Methode für Motoren kleiner-mittlerer Leistung, die Klemmen der Wicklung direkt an die Leitung anzuschließen.

**Démarrage avec connexion directe**

C'est la méthode la plus simple et la plus courante pour les moteurs de petite et moyenne puissance: relier directement les bornes de l'enroulement à la ligne.

**Arranque con conexión directa**

Es el método más simple y usual para motores de potencia pequeña y media, los bornes del devanado se conectan directamente a la línea.

**Avviamento stella triangolo**

Per motori di media-grossa potenza occorre verificare lo spunto di avviamento, in quanto, se origina valori superiori a quanto disponibili in rete occorre provvedere a collegamenti con partenza a stella-triangolo, interponendo, tra la linea ed il motore, un apposito avviatore.

**Starting up with star-triangle**

In motors of medium to high power, it is necessary to ascertain the energy needed to overcome the starting resistance since, if this should be greater than that available in the electrical grid, it will be necessary to use a series of connections with a star-triangle start-up and to place a suitable starter between grid and motor.

**Stern-/Dreieck-Einschaltung**

Für Motoren mittlerer-großer Leistung ist es erforderlich, den Anlaufstrom zu prüfen. Falls dieser größere als im Netz verfügbare Werte vorweist, müssen die Anschlüsse durch eine Stern-Dreieck-Einschaltung mit geeignetem Starter zwischen Leitung und Motor erfolgen.

**Démarrage étoile-triangle**

Pour les moteurs de moyenne-grosse cylindrique, il faut vérifier la puissance absorbée au démarrage, car si elle crée des valeurs supérieures à la puissance disponible sur le secteur, il faut réaliser des connexions avec démarrage en étoile-triangle, en interposant, entre la ligne et le moteur, un démarreur approprié.

**Arranque con estrella-triángulo**

En los motores de potencia media y alta es necesario verificar si el arranque origina tensiones superiores a la disponible en la red, en tal caso, es preciso interponer entre la línea y el motor un dispositivo arrancador tipo estrella-triángulo.

**Posizioni di piazzamento** (Prodotto escluso dal campo di applicazione del Sistema Qualità ISO 9001)

**Mounting positions** (This product is excluded from the scope of ISO 9001 Quality Management System)

**Bauformen** (Dieses Produkt is vom Anwendungsbereich des Qualitätsmanagementsystems ISO 9001 ausgeschlossen)

**Positions de montage** (Ce produit est exclu du domaine d'application du Système de Gestion de la Qualité ISO 9001)

**Posiciones de instalacion** (Esto producto está excluido del campo de aplicación del Sistema de Gestión de la Calidad ISO 9001)

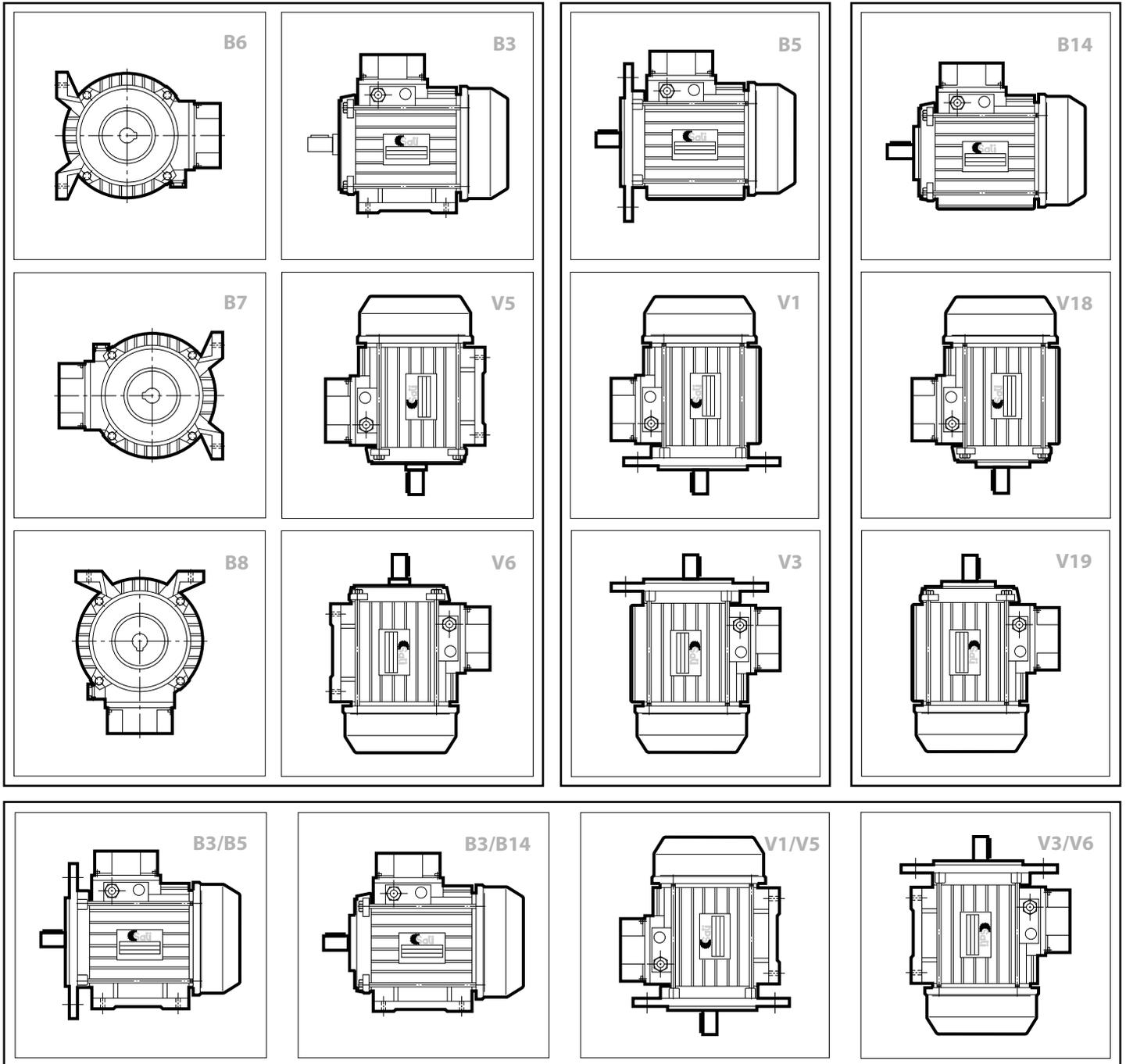



**Elettroventilatori** (Prodotto escluso dal campo di applicazione del Sistema Qualità ISO 9001)

**Electric ventilators** (This product is excluded from the scope of ISO 9001 Quality Management System)

**Elektroventilatoren** (Dieses Produkt ist vom Anwendungsbereich des Qualitätsmanagementsystems ISO 9001 ausgeschlossen)

**Electro-ventilateurs** (Ce produit est exclu du domaine d'application du Système de Gestion de la Qualité ISO 9001)

**Electroventiladores** (Esto producto está excluido del campo de aplicación del Sistema de Gestión de la Calidad ISO 9001)

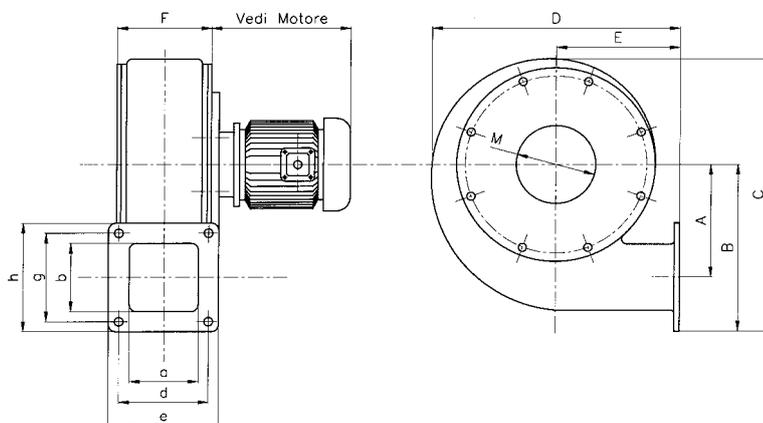
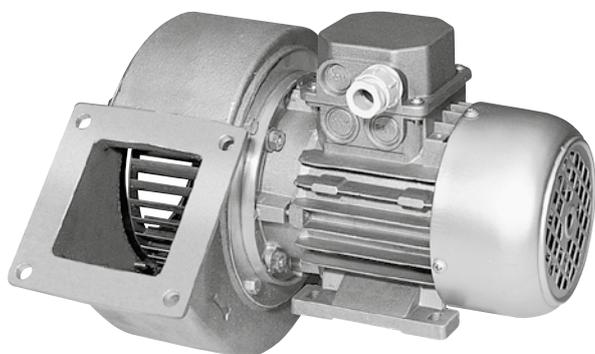

**Dimensioni d'ingombro chiocciola**

(per dimensioni motore vedi pag. 298)

**Dimension of thread**

(for dimension of motors, see page 298)

**Platzbedarf spiralgewände**

(für motorabmessungen siehe seite 298)

**Encombrement carcasse**

(voir page 298 pour les dimensions moteur)

**Dimensiones exteriores de la carcasa**

(para las dimensiones del motor véase la página 298)

Tipo Type Typ Type Tido	kW / Poli kW / Poli kW / Pole kW / Pôles kW / Pulg	A	B	C	D	E	F	M	a	b	d	e	g	h	i
<b>Gr. 11</b>	0,12 / 2	65	118	205	182	87	87	82	67	67	88	106	88	106	8,5
<b>Gr. 11</b>	0,06 / 4	65	118	205	182	87	87	82	67	67	88	106	88	106	8,5
<b>Gr. 16</b>	0,18 / 2	110	172	277	250	125	96	112	75	75	100	123	100	123	8,5
<b>Gr. 16</b>	0,12 / 4	110	172	277	250	125	96	112	75	75	100	123	100	123	8,5

**Pesi**  
(escluso motore elettrico)  
Gr. 11 Kg. 2,1  
Gr. 16 Kg. 3,3

**Weight**  
(excluding electric motor)  
Gr. 11 Kg. 2,1  
Gr. 16 Kg. 3,3

**Gewichte**  
(ausschließlich Elektromotor)  
Gr. 11 Kg. 2,1  
Gr. 16 Kg. 3,3

**Poids**  
(moteur électrique exclu)  
Gr. 11 Kg. 2,1  
Gr. 16 Kg. 3,3

**Pesos**  
(excluido el motor eléctrico)  
Gr. 11 Kg. 2,1  
Gr. 16 Kg. 3,3

**Caratteristiche**

**Carcassa:** alluminio sabbiato  
**Ventola:** pale in lamiera equilibrate dinamicamente e assemblate meccanicamente ai dischi rotanti  
**Coperchio laterale:** lamiera zincata  
**Flangia porta motore:** lamiera zincata  
**Tensioni:** di serie, gli elettroventilatori sono forniti con avvolgimento V.230/400 50 Hz.

**Specifications**

**Casing:** brushed aluminium  
**Fan:** blade in dynamically balanced sheet metal attached mechanically to the rotating disks  
**Side cover:** galvanised sheet metal  
**Motor-holding flange:** galvanised sheet metal  
**Voltage:** the electric ventilators are supplied with a 230/400 V - 50 HZ. winding as a standard feature.

**Eigenschaften**

**Gehuse:** Sandgestrahtes Aluminium  
**Lüfterrad:** Schaufeln in dynamisch ausgewuchtetem Blech und mechanisch an die Drehscheiben montiert  
**Seitendeckel:** Verzinktes Blech  
**Motorträgerflansch:** Verzinktes Blech  
**Spannungen:** Die Elektroventilatoren sind serienmäßig mit Wicklungen V 230/400 50Hz ausgestattet.

**Caracteristiques**

**Carcasse:** aluminium sablé.  
**Ventilateur:** pales en tôle, équilibrées dynamiquement ou assemblées mécaniquement aux disques rotatifs.  
**Couvercle latéral:** tôle galvanisée.  
**Flasque porte-moteur:** tôle galvanisée.  
**Tensions:** standards; les électroventilateurs sont livrés avec un enroulement de 230/400 V - 50 Hz.

**Características**

**Carcasa:** aluminio arenado  
**Ventilador:** paletas de chapa equilibradas dinámicamente y montadas mecánicamente en los discos rotativos.  
**Cubierta lateral:** chapa galvanizada  
**Brida portamotor:** chapa galvanizada  
**Tensiones:** de red, los electroventiladores están provistos de devanado para 230/400 V - 50 Hz



**Pulegge variabili / Adjustable pulleys**  
**Verstellbare keilriemenscheiben**  
**Poulies variables / Poleas variadoras**

**Slitte per motori / Motor slides**  
**Motorschlitten / Glissieres moteurs**  
**Bases tensoras de motores**



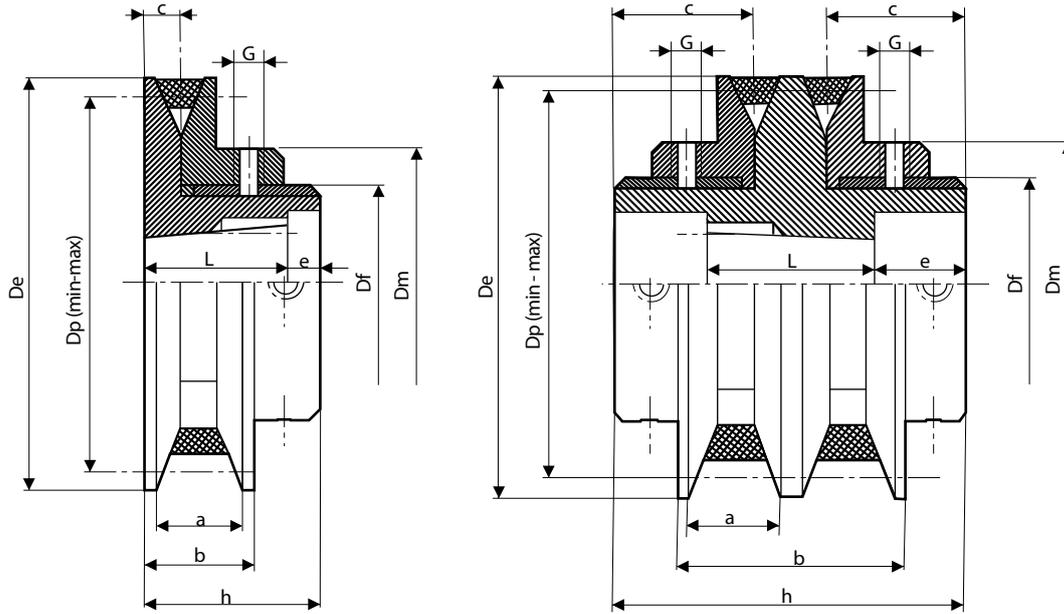

**Ghisa**                      **Cast iron**                      **Grauguss**                      **Fonte**                      **Hierro fundido**  
**EN-GJL-250 UNI EN 1561**    **EN-GJL-250 UNI EN 1561**    **EN-GJL-250 UNI EN 1561**    **EN-GJL-250 UNI EN 1561**    **EN-GJL-250 UNI EN 1561**

**Dimensioni / Dimensions / Abmessungen / Encombremts / Dimensiones**

Tipo Type Typ Type Tido	Nostro codice Our code Unsere kode Notre code Nuestro codigo	Bussola Bush Buchse Bohrung Moyeu Alésage Casquillo	Foro Bore Bohrung Alesage Agujero	De	Dm	Df	Dp		a	a	b	b	c	e	G	h	L	Kg
							min	max										
<b>VAR* 84 Z1</b>	PVZ0841	1108	28	84	65	50	62	80	14,5	10	19,5	15	7,5	-	6	28	28,0	0,50
<b>VAR 95 Z1</b>	PVZ0951	1108	28	95	75	60	73	91	14,5	10	20,5	16	8,0	8,0	6	30	22,0	0,78
<b>VAR 100 Z1</b>	PVZ1001	1108	28	100	75	60	78	96	14,5	10	20,5	16	8,0	8,0	6	30	22,0	0,85
<b>VAR 108 Z1</b>	PVZ1081	1210	30	108	90	72	90	104	14,5	10	20,5	16	8,0	10,0	8	35	25,0	1,13
<b>VAR* 108 A1</b>	PVA1081	1210	30	108	80	62	76	102	19,5	13	26,5	19	9,5	12,0	8	39	27,0	1,12
<b>VAR 120 A1</b>	PVA1201	1210	30	120	91	72	88	114	19,5	13	26,5	20	10,0	10,0	8	36	26,0	1,42
<b>VAR 120 A2</b>	PVA1202	1215	30	120	91	72	88	114	19,5	13	47,1	34	26,0	12,0	8	66	40,5	2,46
<b>VAR 129 A1</b>	PVA1291	1210	30	129	91	72	97	123	19,5	13	26,5	20	10,0	10,2	8	36	26,0	1,67
<b>VAR 129 A2</b>	PVA1292	1215	30	129	91	72	97	123	19,5	13	47,1	34	26,0	12,0	8	66	40,0	2,83
<b>VAR 139 A1</b>	PVA1391	1610	40	139	103	85	109	133	18,9	13	25,9	20	10,0	11,0	8	37	26,0	1,96
<b>VAR 139 A2</b>	PVA1392	1615	40	139	103	85	109	133	18,9	13	46,8	35	26,0	14,5	8	69	38,5	3,37
<b>VAR 146 A1</b>	PVA1461	1610	40	146	103	85	116	140	18,9	13	25,9	20	10,0	11,0	8	37	26,0	2,17
<b>VAR 146 A2</b>	PVA1462	1615	40	146	103	85	116	140	18,9	13	46,8	35	27,0	14,5	8	69	38,5	3,77
<b>VAR 156 A1</b>	PVA1561	1610	40	156	103	85	126	150	18,9	13	25,9	20	10,0	11,0	8	37	26,0	2,43
<b>VAR 156 A2</b>	PVA1562	1615	40	156	103	85	126	150	18,9	13	46,8	35	27,0	14,5	8	69	38,5	4,25
<b>VAR 164 A1</b>	PVA1641	1610	40	164	103	85	134	158	18,9	13	25,9	20	10,0	8,0	8	37	29,0	2,76
<b>VAR 164 A2</b>	PVA1642	1615	40	164	103	85	134	158	18,9	13	46,8	35	27,0	15,5	8	69	37,5	4,74
<b>VAR 177 A1</b>	PVA1771	2012	50	177	135	110	149	171	18,2	13	25,2	20	10,0	8,0	8	40	32,0	3,76
<b>VAR 177 A2</b>	PVA1772	2012	50	177	135	110	149	171	18,2	13	45,5	35	27,5	24,0	8	90	37,0	6,80
<b>VAR 187 A1</b>	PVA1871	2012	50	187	135	110	159	181	18,2	13	25,2	20	10,0	8,0	8	40	32,0	4,14
<b>VAR 187 A2</b>	PVA1872	2012	50	187	135	110	159	181	18,2	13	45,5	35	37,5	24,0	8	90	37,0	7,50
<b>VAR 178 B1</b>	PVB1781	2012	50	178	135	110	139	171	21,5	16	28,5	23	10,0	8,0	8	40	32,0	3,73
<b>VAR 178 B2</b>	PVB1782	2012	50	178	135	110	139	171	22,5	16	54,5	42	37,5	24,0	8	90	37,0	6,75
<b>VAR 187 B1</b>	PVB1871	2012	50	187	135	110	148	180	21,5	16	28,5	23	10,0	8,0	8	40	32,0	4,70
<b>VAR 187 B2</b>	PVB1872	2012	50	187	135	110	148	180	22,5	16	54,5	42	37,5	24,0	8	90	37,0	7,35

\* Montaggio bussola  
contrario allo schema

\* Bush assembly opposite to  
the scheme

\* Entgegengesetzte  
Buchse montage

\* Montage moyeu contraire  
au schema

\* Montaje buje al revés del  
croquis



**Potenza nominale trasmessa / Nominal power / Nominalleistung / Puissance nominale / Potencia nominal  
kW**

Tipo / Type Typ / Type / Tido	1450 rpm		1600 rpm		2000 rpm		2500 rpm		2800 rpm	
	n max	n min	n max	n min	n max	n min	n max	n min	n max	n min
<b>VAR* 84 Z1</b>	1,60	0,80	1,80	1,00	2,00	1,20	2,30	1,40	2,60	1,50
<b>VAR 95 Z1</b>	2,10	1,30	2,42	1,56	2,74	1,80	3,15	2,10	3,69	2,35
<b>VAR 100 Z1</b>	2,30	1,50	2,50	1,80	2,90	2,00	3,20	2,30	3,80	2,60
<b>VAR 108 Z1</b>	2,70	2,00	3,10	2,30	3,10	2,30	3,90	2,90	4,60	3,40
<b>VAR* 108 A1</b>	3,20	1,50	3,79	1,70	4,30	1,96	4,89	2,22	5,64	2,55
<b>VAR 120 A1</b>	3,70	1,80	3,79	2,07	4,34	2,25	4,80	2,52	5,45	2,79
<b>VAR 120 A2</b>	7,40	3,60	7,49	4,14	8,69	4,50	9,61	5,04	10,90	5,58
<b>VAR 129 A1</b>	4,20	2,50	5,20	2,87	6,10	3,70	6,60	4,26	7,50	4,82
<b>VAR 129 A2</b>	8,40	5,00	10,40	5,74	12,20	7,41	13,20	8,52	15,00	9,63
<b>VAR 139 A1</b>	5,00	3,40	5,70	3,90	5,70	3,90	7,30	5,10	8,30	5,70
<b>VAR 139 A2</b>	10,00	6,80	11,40	7,80	11,40	7,80	14,60	10,20	16,60	11,40
<b>VAR 146 A1</b>	5,50	3,80	6,40	4,40	6,40	4,40	8,10	5,60	9,30	6,60
<b>VAR 146 A2</b>	11,00	7,60	12,80	8,80	12,80	8,80	16,20	11,20	18,60	13,20
<b>VAR 156 A1</b>	6,20	4,50	7,20	5,10	7,20	5,10	9,10	6,50	10,40	7,50
<b>VAR 156 A2</b>	12,40	9,00	14,40	10,20	14,40	10,20	18,20	13,00	20,80	15,00
<b>VAR 164 A1</b>	6,70	5,10	7,80	5,70	7,80	5,70	10,00	7,30	11,20	8,30
<b>VAR 164 A2</b>	13,40	10,20	15,60	11,40	15,60	11,40	20,00	14,60	22,40	16,60
<b>VAR 177 A1</b>	7,50	6,10	8,70	7,10	8,70	7,10	11,10	8,00	12,50	10,30
<b>VAR 177 A2</b>	15,00	12,20	17,40	14,20	17,40	14,20	22,60	18,00	25,00	20,60
<b>VAR 187 A1</b>	8,20	6,80	9,50	7,80	9,50	7,80	12,00	10,10	13,60	11,30
<b>VAR 187 A2</b>	16,40	13,60	19,00	15,60	19,00	15,60	24,00	20,20	27,20	22,60
<b>VAR 178 B1</b>	9,30	5,90	10,57	6,32	11,94	7,37	12,66	8,46	13,89	9,24
<b>VAR 178 B2</b>	18,60	11,80	21,14	12,64	25,37	14,63	27,84	15,88	30,53	17,34
<b>VAR 187 B1</b>	10,30	6,80	11,44	7,51	13,73	8,22	14,56	9,44	15,60	10,15
<b>VAR 187 B2</b>	20,60	13,60	22,89	15,02	27,47	16,44	29,13	18,88	31,21	20,30

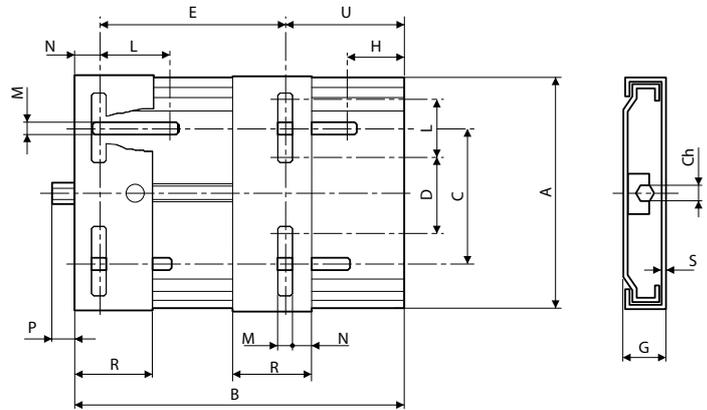

Le slitte tendicinghia per motori elettrici permettono di regolare il tensionamento o lo smontaggio delle cinghie senza rimozione del motore elettrico. Questa caratteristica, e le semplici operazioni di smontaggio, consentono una rapida risoluzione del problema di tensionamento delle cinghie nelle trasmissioni di potenza. La vite che comanda il movimento della slitta si regola infatti con una comune chiave.

La lamiera in acciaio zincato utilizzato per la fabbricazione delle slitte, protegge dalla corrosione e dall'ossidazione.

The motor slides for electric motors allow the tension adjustment or disassembly of the belt without removing the electric motor. This feature, and the easy disassembly, quickly solves the problem of the belt tension in the power transmission. The screw that controls the movement of the motor slide is in fact adjusted by a common key.

The zinc plated steel, used to produce the motor slides, protects against oxidation and corrosion.

Die Schlitten für Elektromotoren ermöglichen die Spannungseinstellung und die Abmontierung des Riemens ohne dass der Elektromotor ausgebaut werden muss. Diese Eigenschaft, und die einfache Demontage, ermöglichen eine schnelle Einstellung der Riemen spannung bei Leistungsantrieben. Die Schraube zum Steuern der Schlittenbewegung wird nämlich durch einen gewöhnlichen Schlüssel eingestellt.

Das verzinkte Stahlblech, das zum Bauen der Schlitten benutzt wird, ist korrosions- und oxydationsfest.

Les glissières de tension permettent de régler le tensionnement ou de démonter les courroies sans déplacer le moteur électrique. Cette caractéristique, ainsi que la facilité de démontage des glissières, permettent de résoudre très rapidement le problème de tensionnement des courroies dans les transmissions de puissance. En effet la vis qui entraîne le mouvement de la glissière se règle à l'aide d'une clé ordinaire.

La tôle en acier zingué utilisée pour la fabrication des glissières est résistante à la corrosion et l'oxydation.

Las bases tensoras para motores eléctricos, permiten el tensado y destensado manual de las correas sin quitar el motor eléctrico. Esta característica y la fácil operación de desmontar el motor, hacen una rápida solución del problema de tensado de las correas para poder transmitir la potencia adecuada. El desplazamiento se regula con un tornillo estándar de fácil manejo.

Estas bases tensoras son fabricadas en acero zincado, esto nos permite mayor dureza contra la oxidación y la corrosión.

**Dimensioni / Dimensions / Abmessungen / Encombremets / Dimensiones**

Nostro codice Our code Unsere kode Notre code Nuestro codigo	A	B	C	D	E	G	H	L	M	N	P	R	S	U	Ch	Grandezza motori Electric motor size Motorenabmessung Dimension moteur Tamaño motores electricos
SL00210	195	210	98	43	100	34	25	50	10,5	20	38	70	3	90	19	63 / 80
SL00270	195	270	98	43	100	33	25	50	10,5	20	38	70	3	150	19	63 / 112
SL00307	213	307	108	65	100	35	30	50	10,5	20	42	70	3	175	19	90 / 112
SL00340	280	340	165	90	135	40	30	62	12,5	27	26	95	4	180	22	90 / 132
SL00430	282	430	165	90	132	40	29	62	12,5	27	30	95	4	271	22	90 / 160
SL00490	410	490	284	193	114	40	30	60	15,0	40	24	95	4	336	22	160 / 180

Giunti dentati  con manicotto in poliammide

Toothed couplings  with pa sleeve

Bogenzahn-Kupplungen der  
Baureihe  mit Hülse aus Polyamid

Accouplements à denture   
avec manchon en polyamide

Acoplamientos dentados   
de manguito en poliamida



# Giunti dentati con manicotto in poliammide Toothed couplings with pa sleeve Bogenzahn-Kupplungen der Baureihe mit Hülse aus Polyamid Accouplements à denture avec manchon en polyamide Acoplamientos dentados de manguito en poliamida

## Giunti flessibili dentati a doppia curvatura

### Presentazione

I giunti flessibili a denti della serie , sono giunti commerciali per impiego generico, che presentano tuttavia un elevato standard qualitativo ed offrono caratteristiche tecniche e prestazioni tipiche dei giunti industriali.

Il settore d'impiego specifico, è quello delle trasmissioni di potenza per il collegamento flessibile di organi rotanti, con possibilità di compensare disallineamenti radiali ed angolari e di assorbire scorrimenti in direzione assiale.

Le prestazioni sono quelle tipiche di questa categoria di giunti, rese più severe e meglio adatte alle esigenze della pratica industriale, dai criteri progettuali adottati e della cura con la quale vengono lavorati e sistematicamente controllati.

### Costruzione

Costruttivamente i giunti flessibili a denti sono costituiti da due mozzi simmetrici in acciaio e da un manicotto in resina sintetica che assicura l'accoppiamento e la trasmissione di potenza tra i due mozzi.

I due mozzi in acciaio a basso tenore di carbonio e con trattamento superficiale anticorrosione, sono dotati ciascuno di una corona dentata.

Il manicotto cavo a dentatura interna ottenuto da stampaggio ad iniezione, è costituito da una tecnopolimero semicristallino ad alto peso molecolare, garantito da certificazione all'origine, condizionato termicamente e caricato con un lubrificante solido che contribuisce ad esaltare le caratteristiche di autolubrificazione tipiche del polimero.

La dentatura dei due mozzi a doppia curvatura progressiva, ottenuta su macchina utensile a CN, assicura al giunto prestazioni ottimali, consentendo la compensazione ANCHE SOTTO CARICO di disassamenti angolari e radiali di natura dinamica.

A parità di un momento torcente trasmesso, la geometria specifica del dente, riduce considerevolmente la pres-

## Flexible gear coupling with double curving

### Introduction

Flexible gear couplings  Series are general purpose commercial couplings, featuring high quality standards as well as technical characteristics and performances which are peculiar of industrial couplings.

Power transmissions are the specific field of application for flexible couplings, that provide flexible connection of rotating elements.

In addition to transmitting torque, gear couplings are able to compensate for radial and angular misalignment as well as minimize axial sliding. Thanks to a superior design and extremely accurate processing and quality control,  couplings ensure enhanced performances with respect to the other couplings of their category, which make them suitable to any industrial application.

### Construction

From a constructive point of view flexible gear couplings are made of two symmetric steel hubs and a synthetic resin sleeve ensuring connection and power transmission between the two hubs.

Each of the two hubs in low carbon steel with anticorrosive surface treatment is fitted with a toothed rim.

The hollow sleeve with internal toothing made by injection moulding is made of semicrystalline technopolymer with high molecular weight.

This material, guaranteed by an original certificate, is thermally conditioned and filled with a solid lubricant heightening the self-lubricating properties of this polymer.

The double incrementally curved toothing of the two hubs, obtained on NC machines, ensures the achievement of optimal performances, enabling compensation of angular and radial misalignments of dynamic type even under load.

In case of equal transmitted torque, the specific tooth geometry minimizes considerably the surface pressure,

## Flexible kupplungen mit doppelt bogenzahnverzahnung

### Allgemeine Beschreibung

Die Bogenzahn-Kupplungen der Baureihe  sind handels-übliche Kupplungen für allgemeine Anwendungen mit den typischen technischen Merkmalen und Leistungen der industriellen Kupplungen, die sich allerdings durch einen hohen Qualitätsniveau hervorheben. Der spezifische Anwendungsbereich für Bogenzahn-Kupplungen der Baureihe  im Rahmen der Antriebstechnik ist die flexible Verbindung zwischen sich drehenden Teilen, sowie der Ausgleich von Radial- und Winkelverlagerungen und die Aufnahme von Axialgleitungen.

Die üblichen Leistungen dieser Kupplungsart wurden durch qualitativ hochwertige Planung, sorgfältige Bearbeitungen und eine einwandfreie Endkontrolle verstärkt, daher eignen sich SG-Kupplungen besser für anspruchsvolle Bedürfnisse in der Industriepraxis.

### Bauweise

bogenzahn-Kupplungen bestehen aus zwei symmetrischen Naben mit Außenverzahnung, die aus einem Stahl mit niedrigem Kohlenstoffgehalt und korrosionsfester Oberflächenbehandlung gefertigt sind.

Die zwei Naben werden durch eine Kunstharz-Außenhülse, die zur Kraftübertragung eine entsprechende Innenverzahnung aufweist, miteinander verbunden.

Die einspritzgegossene Hülse besteht aus einem wärmebehandelten halbkristallinen Technopolymer mit hohem Molekulargewicht, garantiert von einer Originalbescheinigung.

Dieser Werkstoff wird mit einem Schmierstoff gefüllt, das die natürliche Schmierfähigkeit der Polymere aufbessert. Die doppelte progressive Verzahnung der zwei Naben, von numerisch gesteuerten Maschinen ausgeführt, sichert eine optimale Funktion und den Ausgleich dynamischer Kräfte (Winkel- und Radialverlagerungen) auch unter Last

## Accouplements élastiques à denture à double courbure

### Résentation

Les accouplements flexibles série  sont des accouplements commerciaux pour emploi général, qui toutefois présentent un haut niveau de qualité et des caractéristiques techniques et performances propres aux accouplements industriels.

Leur domaine d'emploi spécifique est celui des transmissions de puissance pour la liaison flexible entre deux arbres tournants, avec la possibilité de compenser les désalignements radiaux et angulaire ainsi que d'absorber les glissements en direction axiale.

Leur performances sont celles typiques de cette catégorie d'accouplements, mais rendues plus sévères et donc plus appropriés aux exigences de l'usage industriel grâce aux critères projectuels adoptés et au grand soin avec lequel ils sont usinés et systématiquement contrôlés.

### Construction

Au point de vue constructif, les accouplements flexibles à denture sont constitués par deux moyeux symétriques en acier et un manchon en résine synthétique qui assure le couplage et la transmission de puissance entre les deux moyeux.

Chacun des moyeux, réalisés en acier à faible teneur de carbone et avec traitement de surface anti-corrosion, est pourvu d'une bague dentée sur l'un des deux bords.

Le manchon à denture intérieure obtenu à travers un moulage à injection, est constitué d'un technopolymère demi-cristallin de haut poids moléculaire, garanti par un certificat original, conditionné thermiquement et chargé avec un lubrifiant solide qui aide à exalter les caractéristiques autolubrifiantes du polymère. La denture des deux moyeux à double courbure progressive, obtenue sur machines-outils CNC, assure à l'accouplement des performances optimales, permettant la compensation, même sous charge, de désa-

## Acoplamientos dentados flexibles de doble curvatura

### Presentación

Los acoplamientos dentados flexibles de la serie  son acoplamientos comerciales para uso general, que sin embargo se caracterizan por su elevada calidad y por ofrecer características técnicas y prestaciones típicas de los acoplamientos industriales.

El sector de empleo específico es el de las transmisiones de potencia para la conexión flexible entre órganos giratorios y permiten tanto compensar desalineaciones radiales y angulares, como absorber deslizamientos en dirección axial.

Presentan las prestaciones típicas de esta categoría de acoplamientos y, gracias a los criterios de diseño, al especial cuidado en la fabricación y a los controles sistemáticos, son aún más fiables y se adaptan mejor al uso industrial.

### Construcción

Los acoplamientos dentados flexibles están formados por dos cubos de acero simétricos y un manguito de resina sintética que asegura el acoplamiento y la transmisión de potencia entre los dos cubos. Cada uno de los dos cubos de acero bajos en carbono y con tratamiento superficial anticorrosión tiene una corona dentada.

El manguito hueco dentado interiormente, obtenido a través de moldeo por inyección, está formado por un tecnopolimero semicristalino de elevado peso molecular.

Este material, garantizado por el certificado de origen, está condicionado térmicamente y rellenado de lubricante sólido que contribuye a exaltar las características de autolubricación típicas del polímero. El dentado de los dos cubos de doble curvatura progresiva se obtiene con la máquina herramienta de control numérico y garantiza óptimas prestaciones del acoplamiento, permitiendo la compensación de desalineaciones dinámicas tanto angulares como radiales INCLUSO BAJO CARGA.

Con el mismo par de torsión



**Giunti dentati SG con manicotto in poliammide**  
**Toothed couplings SG with pa sleeve**  
**Bogenzahn-Kupplungen der Baureihe SG mit Hülse aus Polyamid**  
**Accouplements à denture SG avec manchon en polyamide**  
**Acoplamientos dentados SG de manguito en poliamida**

sione superficiale aumentando la capacità di trasmissione del carico da parte del giunto e la sua resistenza alla fatica.

La relativa insensibilità all'umidità atmosferica del polimero e la sua capacità di sopportare temperature tra -20 e +120 gradi Centigradi con punte di breve durata fino a +150 gradi, rendono il giunto idoneo a sopportare condizioni di impiego gravose anche in ambiente ostile.

**Caratteristiche**

In pratica i giunti offrono le sottospecificate prestazioni:

- Ingombro, peso e momento d'inerzia ridotti.
- Comportamento omocinetico alla velocità.
- Silenziosità di marcia e capacità di assorbire elasticamente urti e vibrazioni.
- Resistenza ai più comuni aggressivi chimici ed al calore moderato, max. temp. 80°.
- Sono autolubrificanti, elettricamente isolanti e non richiedono manutenzione.
- Risultano di costo contenuto, di facile montaggio e si prestano ad una molteplicità di impieghi anche gravosi.

while increasing the coupling's endurance as well as its load transmission capacity.

The relative resistance of the polymer to outside humidity and its capacity to endure temperatures between -20°C and +120°C, with short peaks up to +150°C, make the coupling ideal to suffer heavy working conditions even in adverse environments.

**Features and benefits**

- Compact design, reduced weight and moment of inertia
- Constant-velocity movement
- Noiseless running, elastic damping of shocks and vibrations
- Resistance to the most common chemicals and to moderate heat, max 80°C
- Self-lubricating, non-conductive and maintenance-free
- Reasonable price, easy to mount, suitable for multiple duties, even the heaviest ones.

und bei laufendem Betrieb. Bei gleichem übertragenem Drehmoment bewirkt die Geometrie der Zähne eine erhebliche Reduzierung der Flächenpressung. Damit ist die Kupplung in der Lage, höhere Kräfte mit höherer Ermüdungsfähigkeit zu übertragen.

Die relativ geringe Empfindlichkeit des Polymers auf Luftfeuchtigkeit und seine Eigenschaft, Temperaturen zwischen -20°C und +120°C, mit kurzzeitigen Temperaturspitzen bis +150°C, auszuhalten, machen die Kupplung fähig zu größten Belastungen, auch unter ungünstigen Arbeitsbedingungen.

**Merkmale und Nutzen**

SG Bogenzahn-Kupplungen bieten die folgenden Vorteile:

- Kompakte Bauweise - Kleines Gewicht - Reduziertes Trägheitsmoment
- Gleichlaufverhalten
- Geräuscharmer Betrieb
- Elastische Dämpfungsfähigkeit bei Stößen und Vibrationen
- Widerstand gegen die üblichsten Chemikalien und begrenzte Wärme
- Automatische Schmierung
- Elektrisches Isoliervermögen - Wartungsfreiheit
- Günstiger Anschaffungspreis - Leichte Montage
- Vielfalt der Anwendung, auch unter schweren Bedingungen.

lignements angulaires et radiales de nature dynamique. À égalité de moment de torsion transmis, la géométrie spécifique de la dent réduit considérablement la pression superficielle tout en accroissant la capacité de l'accouplement de transmettre la charge ainsi que de résister à la fatigue.

La relative insensibilité à l'humidité atmosphérique du polymère et son endurance à températures entre -20° et +120°C, avec de brefs pics jusqu'à +150°C, rendent l'accouplement apte à endurer des conditions sévères de fonctionnement même dans un environnement hostile

**Caractéristique et avantages**

- Encombrement et poids réduits - Faible inertie
- Comportement homocinétique à la vitesse
- Marche silencieuse - Capacité d'absorber élastiquement les chocs et les vibrations
- Résistance aux produits chimiques plus communs et à la chaleur modérée
- Autolubrifiants - Électriquement isolants - Sans entretien
- De prix avantageux, faciles à monter, ils se prêtent à plusieurs utilisations, même les plus lourdes.

la geometría específica del diente reduce notablemente la presión sobre la superficie, aumentando la capacidad de transmisión de la carga por parte del acoplamiento y su resistencia a la fadiga.

La relativa insensibilidad a la humedad atmosférica del polímero y su capacidad de resistir a oscilaciones de temperatura entre -20°C y +120°C, con picos de breve duración de hasta +150°C, hacen que el acoplamiento resulte adecuado para resistir a condiciones muy difíciles y también a un ambiente hostil.

**Características**

Los acoplamientos ofrecen las siguientes ventajas concretas:

- Dimensiones, peso y momento de inercia reducidos.
- Comportamiento homocinético con respecto a la velocidad.
- Silenciosidad en marcha y capacidad de absorber elásticamente choques y vibraciones.
- Resistencia a los agresivos químicos más usuales y al calor moderado (temperatura máxima 80°C).
- Autolubrificantes, eléctricamente aislantes y no necesitan mantenimiento.
- Tienen un coste reducido, son fáciles de montar y pueden utilizarse para diferentes empleos, incluso pesados.

**Disassamenti**

**Disalignements**

**Auslagerungen**

**Desalignements**

**Desalineaciones**

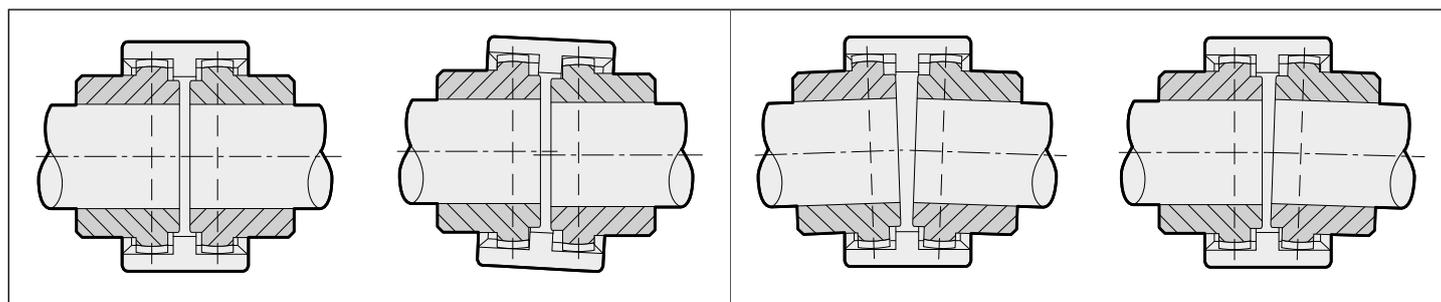

Alberi allineati  
 Aligned shafts  
 Genaue Wellenausrichtung  
 Arbres alignés  
 Ejes alineados

Alberi spostati radialmente  
 Radial misalignment  
 Radialverlagerung  
 Désalignement radial  
 Desalineación radial

Alberi spostati angolarmente  
 Angular misalignment  
 Winkelverlagerung  
 Désalignement angulaire  
 Desalineación angular

Alberi spostati radialmente e angolarmente  
 Radial and angular misalignment  
 Radial- und Winkelverlagerung  
 Désalignement radial et angulaire  
 Desalineación radial y angular

# Giunti dentati con manicotto in poliammide Toothed couplings with pa sleeve Bogenzahn-Kupplungen der Baureihe mit Hülse aus Polyamid Accouplements à denture avec manchon en polyamide Acoplamientos dentados de manguito en poliamida

## Scelta del giunto

Scelta in base alla coppia: il giunto deve essere scelto in modo che la coppia max del motore non superi il momentotorcente di punta ammissibile del giunto.

## Coupling selection

Torque-based selection: the coupling must be chosen basing on the max. motor torque, which should never exceed the coupling's permissible peak torque.

## Kupplungsauswahl

Auswahl nach Drehmoment: die Kupplung muß so ausgewählt werden, daß das max. Motordrehmoment das max. zulässiges Spitzendrehmoment der Kupplung nicht überschreitet.

## Choix de l'accouplement

Choix selon le couple: l'accouplement doit être choisi de façon que le couple max. du moteur ne dépasse pas le couple de crête admissible de l'accouplement.

## Elección del acoplamiento

La elección depende del par: se tiene que elegir el acoplamiento de manera que el par máximo del motor no supere el par máximo de torsión permitido por el acoplamiento.

## Dati tecnici

## Technical data

## Technische daten

## Données techniques

## Datos técnicos

Giunto Tipo Type of coupling Kupplungsart Type d'accouplement Tipo de acoplamiento	Fattore di potenza r.p.m. Power factor rpm Leistungsfaktor Upm Facteur de puissance tpm Factor de potencia r.p.m.		Coppia Torque Drehmoment Couple PAR		Potenza trasmessa in kw a giri/minuto Transmitted power in kw to rpm Übertragene leistung in kw nach upm Puissance transmise en kw a tpm Potencia transmitida en kw a r.p.m.								Giri/1' Max. Rpm/1' max Tours/1' Max. Upm/1' max Revoluciones/1'	(1) Massa Mass Masse Masa	(1) J Kg cm <sup>2</sup>	Disassamento Massimo per Ogni mozzo Max. Disalignment per hub Max. Verlagerung für jede nabe Désalignement max. Pour chaque moyeu Desalineación máx. Por cada cubo		Spostamento assiale Axial misalignment Axialverlagerung Désalignement axial Desalineación axial		
	norm.	max.	norm.	max.	750		1000		1500		3000					Kg	Angol. Angular Winkul Angul Angular (2)		Radial mm.	mm.
					norm.	max.	norm.	max.	norm.	max.	norm.	max.								
<b>SG-14</b>	0.0011	0.0023	11,5	23,0	0,8	1,5	1,1	2,0	1,6	3,0	3,3	6,0	14000	0,166	0,27	± 2°	0,7	± 1		
<b>SG-19</b>	0.0019	0.0037	18,5	36,5	1,3	2,7	1,8	3,7	2,7	5,5	5,4	11,1	12000	0,276	0,64	± 2°	0,8	± 1		
<b>SG-24</b>	0.0023	0.0047	23,0	46,0	1,7	3,5	2,3	4,7	3,4	7,0	6,9	14,1	10000	0,312	0,92	± 2°	0,8	± 1		
<b>SG-28</b>	0.0053	0.0106	51,5	103,5	3,9	7,9	5,2	10,6	7,8	15,9	15,6	31,8	8000	0,779	3,45	± 2°	1,0	± 1		
<b>SG-32</b>	0.0071	0.0142	69,0	138,0	5,2	10,5	7,0	14,1	10,5	21,1	21,0	42,3	7100	0,918	5,03	± 2°	1,0	± 1		
<b>SG-38</b>	0.0090	0.0181	88,0	176,0	6,7	13,5	9,0	18,0	13,5	27,0	27,0	54,0	6300	1,278	9,59	± 2°	0,9	± 1		
<b>SG-42</b>	0.0113	0.0226	110,0	220,0	8,4	16,8	11,2	22,5	16,8	33,7	33,6	67,5	6000	1,473	13,06	± 2°	0,9	± 1		
<b>SG-48</b>	0.0158	0.0317	154,0	308,0	11,8	23,6	15,8	31,6	23,7	47,4	47,4	94,8	5600	1,777	18,15	± 2°	0,9	± 1		
<b>SG-55</b>	0.0290	0.0580	285,0	570,0	21,7	43,5	29,0	58,0	43,5	87,0	87,0	174,0	4800	3,380	49,44	± 2°	1,2	± 1		
<b>SG-65</b>	0.0432	0.0865	420,0	840,0	32,1	64,3	42,9	85,8	64,3	128,7	128,7	257,4	4000	4,988	106,34	± 2°	1,3	± 1		

- (1) Riferimento al giunto normale completo di foro massimo senza cava.  
(2) Per mozzo

- (1) Refers to the standard coupling complete with max. bore and no keyway.  
(2) Per hub

- (1) Bezieht sich auf die Standardkupplung versehen mit max. Bohrung ohne Nut.  
(2) Für jede Nabe

- (1) Se réfère à l'accouplement standard pourvu d'alésage max. sans rainure.  
(2) Pour chaque moyeu

- (1) Relativo al acoplamiento estándar con agujero máximo sin ranura.  
(2) Por cada cubo

## Norme per il montaggio

- Fissare i due semi-giunti agli alberi, facendo attenzione che le facciate interne siano a filo con le estremità degli alberi.
- Infilare il manicotto sui due semigiunti regolando la distanza degli stessi (quota "S") allineando contemporaneamente i due alberi.
- Fissare in posizione i due elementi da accoppiare.
- Prima di far ruotare il giunto verificare che il manicotto sia libero di spostarsi assialmente.

## Mounting instructions

- Fasten the two half-couplings to their respective shafts, making sure that their inner sides are flush with the shaft ends.
- Drive the sleeve onto the two half-couplings while adjusting the distance between them („S“ dimension) and aligning the two shafts.
- Bring the two elements you wish to connect to their respective positions.
- Before you rotate the coupling, make sure that the sleeve is free to travel axially.

## Montageanleitungen

- Die zwei Kupplungshälfte an die Wellen befestigen, unter Berücksichtigung, daß die inneren Seiten mit den Wellenenden fluchtend angeordnet sind.
- Die zwei Kupplungshälfte in die Hülse stecken, und dabei den Abstand zwischen den (Abmessung „S“) regulieren und gleichzeitig die zwei Wellen aneinander fluchten.
- Die zu verbindenden Elemente in Position bringen.
- Bevor Sie die Kupplung kreislen lassen, vergewissern Sie sich, daß sich die Hülse axial frei bewegen kann.

## Instructions de montage

- Fixer les deux demi-accouplements sur les arbres, en s'assurant que les surfaces intérieures soient en droite ligne avec les bouts des arbres.
- Introduire les deux demi-accouplements dans le manchon et régler la distance entre eux (dimension S), en alignant en même temps les deux arbres.
- Fixer en position les éléments à accoupler.
- Avant de faire tourner l'accouplement, s'assurer que le manchon soit libre de se déplacer axialement.

## Instrucciones para el montaje

- Fijar los dos cubos sobre los ejes, controlando que las superficies interiores se encuentren a ras de los extremos de los ejes.
- Introducir los dos cubos dentro del manguito regulando la distancia entre los mismos (cota "G"), alineando simultáneamente los dos ejes.
- Fijar en posición los elementos a acoplar.
- Antes de efectuar la rotación del acoplamiento, verificar que el manguito pueda desplazarse libremente en sentido axial.

**Giunti dentati SG con manicotto in poliammide**  
**Toothed couplings SG with pa sleeve**  
**Bogenzahn-Kupplungen der Baureihe SG mit Hülse aus Polyamid**  
**Accouplements à denture SG avec manchon en polyamide**  
**Acoplamientos dentados SG de manguito en poliamida**

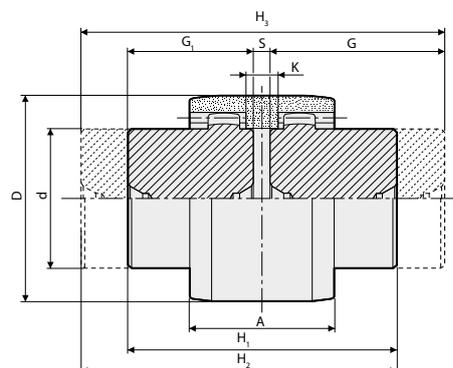
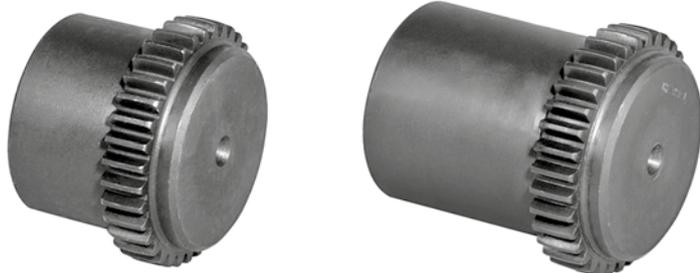

Caratteristiche dentatura / Tothing features / Verzahnungsmerkmale / Caractéristiques de denture / Características de la dentura

Tipo / Type Typ / Type / Tipo	Mod.	Z	Angolo pressione / Pressure angle Eingriffwinkel / Angle de pression / Angulo de presion	De	Dp	Spessore dente / Tooth Width Zahnbreite / Larger denture / Ancho dente
<b>SG-14</b>	1,5	20	20°	33	30	8
<b>SG-19</b>	1,5	24	20°	39	36	8
<b>SG-24</b>	1,5	28	20°	45	42	8
<b>SG-28</b>	1,5	34	20°	54	51	10
<b>SG-32</b>	1,5	40	20°	63	60	10
<b>SG-38</b>	1,5	44	20°	69	66	12
<b>SG-42</b>	1,5	50	20°	78	75	14
<b>SG-48</b>	1,5	50	20°	78	75	14
<b>SG-55</b>	2,0	45	20°	94	90	16
<b>SG-65</b>	2,5	42	20°	110	105	20

Acciaio = C. 43 UNI 7847

Steel = C. 43 UNI 7847

Stahl = C. 43 UNI 7847

Acier = C. 43 UNI 7847

Acero = C. 43 UNI 7847

**Esempio codifica**

SG-14-CC = con 2 mozzi corti  
 SG-14-LC = con un mozzo lungo e uno corto  
 SG-14-LL = con 2 mozzi lunghi

**Code explanation**

**example**  
 SG-14-CC = with 2 hubs short  
 SG-14-LC = Hub long-short  
 SG-14-LL = Hub long-long

**Kodierungsbeispiel**

SG-14-CC = mit 2 kurzen Naben  
 SG-14-LC = mit einer langen und einer kurzen Nabe  
 SG-14-LL = mit 2 langen Naben

**Interpretation du**

**code**  
 SG-14-CC = avec 2 moyeux courts  
 SG-14-LC = avec un moyeu long et un court  
 SG-14-LL = avec 2 moyeux longs

**Ejemplo codificación**

SG-14-CC = con 2 cubos cortos  
 SG-14-LC = con 1 cubo corto y 1 largo  
 SG-14-LL = con 2 cubos largos

Dimensioni / Dimensions / Abmessungen / Encombremets / Dimensiones mm

Tipo Type Typ Type Tipo	Foro / Bore Foro / Bore Foro		A	d	G	G <sub>1</sub>	D	S	K	H <sub>1</sub>	H <sub>2</sub>	H <sub>3</sub>	Mozzo corto Short hub Kurze Nabe Moyeu court Cubo corto	Mozzo lungo Long hub Lange Nabe Moyeu long Cubo largo	Manicotto in poliammide Polyamide sleeve Hülse aus Polyamid Manchon en polyamide Manguito en poliamida
	min	max													
<b>SG-14</b>	6	14	37	24	40	23	40	4	6	50	67	84	0,09	0,15	0,02
<b>SG-19</b>	8	19	37	30	40	25	48	4	6	54	69	84	0,15	0,23	0,03
<b>SG-24</b>	10	24	41	36	50	26	52	4	8	56	80	104	0,21	0,40	0,04
<b>SG-28</b>	10	28	46	44	55	40	66	4	9	84	99	114	0,48	0,66	0,07
<b>SG-32</b>	12	32	48	50	55	40	76	4	9	84	99	114	0,63	0,86	0,09
<b>SG-38</b>	14	38	48	58	60	40	83	4	9	84	104	124	0,83	1,25	0,11
<b>SG-42</b>	20	42	50	65	60	42	92	4	9	88	106	124	1,11	1,58	0,14
<b>SG-48</b>	20	48	50	67	60	50	95	4	9	104	114	124	1,37	1,65	0,16
<b>SG-55</b>	25	55	58	82	65	52	114	4	10	108	121	134	2,12	2,66	0,26
<b>SG-65</b>	25	65	68	95	70	55	132	4	12	114	129	144	3,07	3,92	0,39

**Quote di montaggio**

A richiesta: Foro finito secondo le norme ISO, tolleranza H7 - chiave DIN 6885, tolleranza JS9. Foro per grano.

**Assembly distances**

On request: Finished bore in compliance with ISO standards, H7 tolerance - keyway to DIN 6885, JS9 tolerance. Bore for screws.

**Montageabmessungen**

Nach Wunsch: Fertigbohrung nach ISO Normen, Toleranz H7 - Paßfedernut nach DIN 6885, Toleranz JS9. Gewindebohrung.

**Dimensions de montage**

Sur demande: Alésage fini selon normes ISO, tolérance H7 - Rainure de clavette à DIN 6885, tolérance JS9. Trou taraudé.

**Bajo solicitud**

eje acabado según las normas ISO, tolerancia H7 chavetero DIN 6885, tolerancia JS9. Eje con prisonero.

**Giunto dentato completo**

**Full toothed coupling**

**Bogenzahn - Kupplung komplett**

**Accouplement a denture complet**

**Acoplamiento dentado completo**



	tipo / type / tipo / type / tipo <b>SG-CC</b>	tipo / type / tipo / type / tipo <b>SG-LC</b>	tipo / type / tipo / type / tipo <b>SG-LL</b>
<b>Nostro codice</b> <b>Our code</b> <b>Unser Code</b> <b>Notre code</b> <b>Nuestro código</b>	SGCC014	SGLC014	SGLL014
	SGCC019	SGLC019	SGLL019
	SGCC024	SGLC024	SGLL024
	SGCC028	SGLC028	SGLL028
	SGCC032	SGLC032	SGLL032
	SGCC038	SGLC038	SGLL038
	SGCC042	SGLC042	SGLL042
	SGCC048	SGLC048	SGLL048
	SGCC055	SGLC055	SGLL055
SGCC065	SGLC065	SGLL065	

**Semigiunto dentato mozzo corto**  
**Semi-coupling short hub**  
**Halbkupplung kurze Nabe**  
**Demi - accouplement moyeu court**  
**Semiacoplamiento dentado cubo corto**

**Semigiunto dentato mozzo lungo**  
**Semi-coupling long hub**  
**Halbkupplung lange Nabe**  
**Demi - accouplement moyeu long**  
**Semiacoplamiento dentado cubo largo**

**Manicotto in poliammide**  
**Polyamide sleeve**  
**Polyamid Hülse**  
**Manchon en polyamide**  
**Manguito en poliamida**



<b>Nostro codice</b> <b>Our code</b> <b>Unser Code</b> <b>Notre code</b> <b>Nuestro código</b>	SG0C014
	SG0C019
	SG0C024
	SG0C028
	SG0C032
	SG0C038
	SG0C042
	SG0C048
	SG0C055
SG0C065	

<b>Nostro codice</b> <b>Our code</b> <b>Unser Code</b> <b>Notre code</b> <b>Nuestro código</b>	SG0L014
	SG0L019
	SG0L024
	SG0L028
	SG0L032
	SG0L038
	SG0L042
	SG0L048
	SG0L055
SG0L065	

<b>Nostro codice</b> <b>Our code</b> <b>Unser Code</b> <b>Notre code</b> <b>Nuestro código</b>	SG0M014
	SG0M019
	SG0M024
	SG0M028
	SG0M032
	SG0M038
	SG0M042
	SG0M048
	SG0M055
SG0M065	

**Giunti elastici torsionali  
esecuzione precisa  con elemento elastico**

** torsional flexible couplings in precise  
execution with elastic element**

**Drehelastische Kupplungen in genauer  
Ausführung  mit elastischem Zwischenglied**

**Accouplements elastiques torsionnels  
execution precise  avec anneau elastique**

**Acoplamientos elásticos torsionales ejecución  
precisa  con elemento elástico**



# Giunti elastici torsionali esecuzione precisa con elemento elastico Drehelastische Kupplungen in genauer Ausführung mit elastischem Zwischenglied Accouplements elastiques torsionnels execution precise avec anneau elastique Acoplamientos elásticos torsionales ejecución precisa con elemento elástico

## Introduzione

I giunti elastici torsionali sono costituiti da due mozzi in ghisa che presentano ognuno delle sporgenze sul perimetro esterno che puntano verso il mozzo opposto. I due mozzi si innestano liberamente l'uno nell'altro, e la cavità che si produce al centro viene riempita da un elemento di interposizione in materiale elastomero a forma di asterisco.

I giunti sono organi di collegamento tra alberi rotanti, e svolgendo questa funzione assicurano contemporaneamente le seguenti prestazioni:

- Rendere la trasmissione esente da urti, smorzando le eventuali vibrazioni dovute al carico o autoindotte
- Attenuare urti e picchi di coppia in fase di avviamento
- Compensare in esercizio leggeri difetti di allineamento tra gli alberi stessi

Per garantire queste prestazioni ad un elevato livello qualitativo e mantenere una buona durata in esercizio, abbiamo curato in modo particolare le lavorazioni, la scelta dei materiali e il controllo finale del prodotto.

## Caratteristiche

Caratteristica saliente di questo tipo di giunti è l'elemento di interposizione, determinante per la coppia nominale di ogni giunto.

Il materiale costruttivo dell'elemento di interposizione è di importanza cruciale per la risposta del giunto a fattori di contrasto come vibrazioni, temperatura, agenti chimici, disallineamento, elevati valori di RPM.

La curva che esprime la caratteristica elastica dell'elemento di interposizione deve avere andamento progressivo (cedevole ai bassi valori di coppia e rigido ai valori più elevati) per assicurarne un funzionamento privo di strappi in avviamento ed in cedimento torsionale contenuto a regime. Anche la durata in esercizio del giunto dipende dalla resa elastica del materiale di tale elemento.

A seconda delle applicazioni e delle condizioni di lavoro

## Introduction

The design of flexible couplings is characterized by two cast iron hubs having each stubby protrusions around their perimeters pointing toward the opposite hub.

The two hubs mesh loosely together, and the gaps between them are filled with blocks of elastomeric material, moulded into an asterisk-shaped element called "spider".

Couplings are elements connecting two rotating shafts, and beyond transmitting power from one shaft to the other they perform the following functions:

- Ensure a torque transmission free from shocks by damping any torsional vibrations, either due to load or self-induced
- Minimize torque shocks and peaks at a starting phase
- Compensate for slight angular and parallel shaft misalignments

In order to guarantee all above performances at a superior quality level while ensuring good service life, Sati chooses only the best materials and arranges for accurate processing and faultless quality control.

## General features

In flexible couplings the spider is the element determinant for the torque rating of every coupling.

Its constructive material can make a significant difference in the coupling response to contrast factors such as vibration, temperature, chemicals, misalignment, high RPM.

The curve expressing the spider's elasticity must have a progressive trend (yielding at low torque values and rigid at higher torque values) so as to avoid tugs at starting as well as ensure a moderate torsional yielding by regular running. Also the coupling life depends from the elastic prop-

## Allgemeine Beschreibung

Drehelastische Kupplungen bestehen aus zwei kongruenten Kupplungshälften, die innenseitig mit konkav ausgebildeten Klauen versehen sind, die in Umfangsrichtung gegeneinander versetzt stehen und sind so gestaltet, daß in dem Raum dazwischen ein elastischer Zahnkranz eingelegt werden kann.

Kupplungen sind Verbindungselemente zwischen rotierenden Wellen.

Indem sie diese Funktion erfüllen, ermöglichen sie gleichzeitig die folgenden Leistungen:

- Eine stoßfreie Kraftübertragung, mit Dämpfung der durch Belastung verursachten oder selbsterzeugten Schwingungen
- Dämpfung von Stößen und Spitzendrehmomenten in der Anlaufphase
- Ausgleichen von kleinen Fluchtungsfehlern zwischen den Wellen während des Betriebs

Um die obigen Leistungen bei einem hohen Qualitätsniveau zu gewährleisten und eine gute Lebensdauer in Betrieb zu erhalten, werden Werkstoffe sorgfältig gewählt und sämtliche Bearbeitungen sowie die Endkontrolle gewissenhaft ausgeführt.

## Technische Merkmale

Das Zwischenglied, entscheidend für das Nenn Drehmoment jeder Kupplung, gilt als springende Punkt dieser Kupplungen.

Der Werkstoff des Zwischengliedes ist maßgebend für eine ange-messene Reaktion der Kupplung auf Kontrastfaktoren wie z.B. Schwingungen, Temperatur, Chemikalien, Verlagerung, hohe Drehzahl.

Die Linie, die die elastischen Eigenschaften des Zwischengliedes darstellt, soll einen fortschreitenden Verlauf aufzeigen (nachgiebig bei niedrigen und steif bei höheren Drehmomentwerten), um einen ruckfreien Anlauf sowie einen mäßigen Verdrehnachsen in vollem Betrieb zu sichern.

Zur optimalen Dämpfung der Drehschwingungen weist das

## Description generale

Les accouplements élastiques en torsion sont constitués de deux moyeux en fonte ayant chacun des tenons sur le périmètre extérieur qui pointent vers le moyeu opposé. Les deux moyeux s'enclenchent librement l'un dans l'autre, et la cavité qui se produit entre eux est remplie par un élément d'interposition en matériau élastomérique en forme d'étoile.

Les accouplements sont organes de jonction entre arbres tournants, et en plus de cette fonction ils assurent en même temps les performances suivantes:

- Permettre une transmission sans chocs, en amortissant toute vibration due à la charge ou auto-induite
- Affaiblir les chocs et les pics de couple en phase de démarrage.
- Compenser en service des défauts légers d'alignement entre les arbres mêmes

Pour garantir ces performances à un haut niveau de qualité tout en maintenant une bonne durée en service, nous avons soigné particulièrement le choix des matériaux, les usinages et le contrôle final du produit.

## Caracteristiques

Le trait saillant de ce type d'accouplement est l'élément d'interposition, déterminant pour le couple nominal de chaque accouplement. Le matériau constructif de cet élément a une importance cruciale pour la réponse de l'accouplement aux facteurs de contraste comme les vibrations, la température, les agents chimiques, le désalignement ou valeurs élevées de TPM.

La courbe qui exprime la qualité élastique de l'étoile doit avoir une tendance progressive (flexible avec un petit moment de torsion et rigide avec un moment de torsion élevé) afin d'assurer un démarrage doux et un fléchissement torsionnel modéré, moteur en marche. Même la durée d'exercice de l'accouplement dépend du rendement élastique du matériau

## Introducción

Los acoplamientos elásticos torsionales están formados por dos cubos de fundición cada uno de los cuales presenta salidizos en el perímetro exterior que apuntan hacia el cubo opuesto. Los dos cubos se acoplan libremente el uno dentro del otro y la cavidad que se forma en el centro es llenada por un elemento de interposición en material elastomérico en forma de asterisco.

Los acoplamientos son órganos de conexión entre ejes giratorios, que desarrollando esta función garantizan todas las siguientes prestaciones al mismo tiempo:

- Hacer que la transmisión esté exenta de golpes, amortiguando eventuales vibraciones debidas a la carga o autoinducidas.
- Atenuar golpes y picos de par en fase de arranque.
- Compensar durante el servicio ligeros desperfectos de alineación entre los ejes los mismos ejes.

Para garantizar dichas prestaciones a una elevada calidad manteniendo una buena duración del servicio, hemos puesto especial cuidado en la fabricación, la elección de los materiales y el control final del producto.

## Características

La característica principal de este tipo de acoplamientos es el elemento de interposición, que resulta fundamental para el par nominal de cada acoplamiento. El material de construcción del elemento de interposición es sumamente importante para que el acoplamiento responda a factores de contraste tal como vibraciones, temperatura, agentes químicos, desalineación y elevados valores de r.p.m..

La curva que expresa la característica elástica del elemento de interposición debe ser progresiva (flexible a bajos valores de par y rígida con valores de par más elevados) para garantizar un funcionamiento uniforme en fase de arranque y una cesión torsional limitada al régimen. También la duración en servicio del acoplamiento depende del ren-

# Giunti elastici torsionali esecuzione precisa con elemento elastico

## flexible couplings in precise execution with elastic element

## Drehelastische Kupplungen in genauer Ausführung mit elastischem Zwischenglied

## Accouplements elastiques torsionnels execution precise avec anneau elastique

## Acoplamiento elástico torsional ejecución precisa con elemento elástico



sarà opportuno scegliere il materiale più appropriato. Nella esecuzione base viene utilizzato per la corona dentata un elastomero termoplastico scelto per soddisfare esigenze di medio livello. Si tratta di un elastomero di rigidità media, caratterizzato da uno smorzamento interno ottimale, resistente all'invecchiamento, alla fatica, all'abrasione nonché all'idrolisi e ai principali agenti chimici, con particolare riferimento agli olii e all'ozono. Per i giunti in esecuzione base sono ammesse temperature d'esercizio comprese tra -40°C e +125°C con brevi punte fino a 150°C.

Per l'impiego in condizioni di esercizio estreme o comunque per esigenze superiori alla media, sono state studiate e sono disponibili a richiesta mescole alternative in grado di soddisfare ogni necessità pratica.

Il grande vantaggio dei giunti elastici torsionali è che anche in caso di distruzione dell'elemento elastico centrale durante il funzionamento, il sistema continuerà a funzionare con sicurezza evitando così i tempi morti della riparazione di emergenza. L'elemento di interposizione potrà quindi essere sostituito in un momento più opportuno.

### Applicazioni

I giunti elastici torsionali sono particolarmente indicati per macchine azionate da motori elettrici in servizio continuo, pompe, riduttori ecc.

### Condizioni di impiego e montaggio

I fattori che caratterizzano il funzionamento dei giunti elastici a torsione quali gli  $\bullet$  sono la proporzionalità tra coppia torcente ed angolo di torsione e la capacità di compensare disassamenti angolari e radiali di modesta entità. Valori altrettanto qualificanti ma di più difficile interpretazione sono il fattore di smorzamento e la frequenza naturale o di risonanza.

Per la qualificazione dei suoi giunti, la Sati S.p.A dichiara valori di coppia torcente ammissibile correlati a ben definiti valori dell'angolo di torsione che in corrispondenza

erties of the spider's material. The choice of the appropriate materials largely depends on the different applications and working conditions. In the basic execution the spider is made of a plastic elastomer selected to meet medium purpose requirements, offering medium rigidity and excellent internal damping, resistant to ageing, fatigue, abrasion, hydrolysis as well as to most common chemicals, such as oils and ozone.

In the basic execution couplings the operating temperatures range from -40°C to +125°C, allowing for short peaks up to 150°C.

For use in extreme working conditions or simply above standard, special compounds have been studied to cope with any type of practical application.

The great advantage of flexible couplings lies in their "fail-safe" design, as the coupling is not necessarily destroyed or rendered inoperable if the spider breaks away during operation.

The system will continue to function in safety conditions, preventing critical system downtime, until the spider can be replaced at a more convenient moment.

### Applications

Flexible couplings are generally recommended for continuous-duty electric motor-driven machinery, pumps, gearboxes etc.

### Installation and use

The main factors affecting the operation of flexible couplings such as  $\bullet$  couplings are the proportionality between torque and torsion angle and the capacity to compensate for moderate angular and radial misalignments.

Other important factors, though more difficult to interpret, are damping factor and natural frequency or resonance frequency.

For the rating of its couplings, Sati S.p.A states permissible

Zwischenglied eine der erforderlichen Dämpfungswirkung angemessene elastische Hysterese.

Auch die Lebensdauer bei Betrieb der Kupplung wird durch die Rückprall-Elastizität vom Zwischengliedswerkstoff beeinflusst.

Je nach Anwendungsfall und Betriebsverhältnissen muß den geeigneten Werkstoff gewählt werden. In der Grundausführung wird für den Zahnkranz ein Plastik-Elastomer verwendet, den für mittlere Betriebsverhältnisse ausgedacht wurde.

Es handelt sich um einen Elastomer mittlerer Härte, der durch eine optimale innere Dämpfung gekennzeichnet ist, verschleiß-, reib- und alterungsbeständig, sowie hydrolyse- und chemikalienfest, insbesondere öl- und ozonfest. Für die Kupplungen in Grundausführung wird bei einer Betriebstemperatur zwischen -40°C und +125°C, mit kurzzeitigen Temperaturspitzen bis +150°C, einen einwandfreien Betrieb gesichert.

Im Falle von äußersten oder einfach außerordentlichen Betriebsbedingungen, wurden spezielle Mischungen ausgedacht, die nach Wunsch verfügbar sind, um jeglicher praktischer Anwendung nachzukommen.

Der größte Vorteil an drehelastischen Kupplungen ist ihre Durchschlagsicherheit. Tatsächlich, auch im Fall einer Zerstörung des Zwischengliedes während des Betriebs, wird die Anlage weiter in Sicherheit funktionieren, und dadurch werden unnötige Zeiterschwendungen vermieden.

Das Zwischenglied kann dann nachher, in einem günstigerem Augenblick ersetzt werden.

### Einsatzbereiche

Drehelastische Kupplungen lassen sich sehr gut in Elektromotorantrieben in Dauerbetrieb, wie z.B. Pumpen und Getrieben, einsetzen

### Einsatz- und Einbaubedingungen

Die unterscheidenden Faktoren für den Betrieb der drehelastischen Kupplungen

constructif de l'étoile.

Le choix du matériau plus approprié doit se faire en suivant les différentes applications et les conditions de travail. Dans la version base on utilise pour l'étoile un elastomère thermoplastique, choisi pour satisfaire des exigences de niveau moyen. Il s'agit d'un elastomère de rigidité moyenne, caractérisé par un amortissement intérieur optimal, résistant au vieillissement, à la fatigue, à l'abrasion ainsi qu'à l'hydrolyse et aux agents chimiques les plus communs, et notamment les huiles et l'ozone.

Pour les accouplements en version de base la plage de température admissible est comprise entre -40°C et +125°C avec de brefs pics jusqu'à 150°C. Pour des conditions extrêmes de fonctionnement ou en tous cas pour des exigences supérieures aux normes, des mélanges alternatifs ont été étudiés pour satisfaire toute exigence pratique et sont disponibles sur demande des clients.

Le grand avantage des accouplements élastiques est leur caractéristique "sans échec", c'est à dire qu'en cas de destruction de l'élément élastique central pendant le fonctionnement, l'installation continue à travailler en sécurité, tout en évitant les pertes de temps liées aux dépannages. L'élément d'interposition pourra donc être remplacé dans un moment plus favorable.

### Applications

Les accouplements élastiques trouvent leur emploi idéal dans les machines entraînées par des moteurs électriques en service continu, pompes, réducteurs etc.

### Conditions de fonctionnement et montage

Les facteurs caractérisant le fonctionnement des accouplements élastiques à torsion tels que les accouplements  $\bullet$  sont la proportionnalité entre le couple de torsion et l'angle de torsion, ainsi que la capacité de compenser les défauts d'alignement angulaires et radiaux modérés. Valeurs éga-

dimiento elástico del material de dicho elemento.

Según las aplicaciones y las condiciones de trabajo es conveniente elegir el material más adecuado. Durante las ejecuciones de base para la corona dentada se utiliza un elastómero termoplástico elegido para satisfacer exigencias de medio nivel.

Se trata de un elastómero de rigidez media, caracterizado por una amortiguación interior óptima, resistente al envejecimiento, al esfuerzo, a la abrasión, así como a la hidrólisis y a los principales agentes químicos, en particular a los aceites y al ozono.

Durante las ejecuciones de base las temperaturas de servicio permitidas de los acoplamiento deben estar comprendidas entre -40 °C y +125 °C con breves picos de hasta +150 °C.

Para emplearse en condiciones de trabajo extremas y, en general, para exigencias superiores a la media, han sido estudiadas, y están disponibles bajo pedido, mezclas alternativas capaces de satisfacer toda necesidad de tipo práctico.

La gran ventaja de los acoplamiento elásticos torsionales es que también en caso de destrucción del elemento elástico central durante el funcionamiento, el sistema sigue funcionando en condiciones de seguridad, evitando de esta manera los tiempos muertos debidos a las reparaciones de emergencia. Por lo tanto, el elemento de interposición podrá ser sustituido en un momento más adecuado.

### Aplicaciones

Los acoplamiento elásticos torsionales son particularmente indicados para las máquinas accionadas por motores eléctricos de servicio continuo, bombas, reductores etc.

### Condiciones de empleo y montaje

Los factores que caracterizan el funcionamiento de los acoplamiento elásticos torsionales tales como los  $\bullet$  son la proporcionalidad entre el par de torsión y el ángulo de torsión y la capacidad de compensar

# Giunti elastici torsionali esecuzione precisa con elemento elastico Drehelastische Kupplungen in genauer Ausführung flexible couplings in precise execution with elastic element Accouplements elastiques torsionnels execution precise avec anneau elastique Acoplamientos elásticos torsionales ejecución precisa con elemento elástico

della coppia massima assume il valore limite di 5°.

Ciò fornisce un valido orientamento circa la progressività della curva elastica.

Per i disassamenti angolare e radiale vengono riportati i valori massimi ammissibili, con l'avvertenza che si tratta di valori estremi, non cumulabili (solo compensazione angolare o solo compensazione radiale) e validi per condizioni di funzionamento "standard" caratterizzate da: coppia di esercizio non superiore alla coppia nominale, velocità di rotazione inferiore a 1450 giri/min, la massima velocità di rotazione cui corrisponde una velocità periferica massima di 30 m/sec.

Questa velocità può venir raggiunta con sufficiente margine di sicurezza rispetto al pericolo di rottura per sollecitazione a forza centrifuga grazie alle caratteristiche del materiale impiegato.

Nonostante i semigiunti siano completamente lavorati su ogni superficie esterna, si raccomanda la bilanciatura dinamica in classe G 2,5 secondo ISO 1940 qualora la velocità di funzionamento effettivo superi i 2800 giri/min.

## Criteri di scelta e dimensionamento del giunto

Il dimensionamento dei giunti viene fatto in base alle leggi fisiche della meccanica e della resistenza dei materiali e risulta per altro conforme a quanto prescritto dalla norma DIN 740 Foglio 2. Per la scelta del giunto vale il criterio per cui anche nelle peggiori condizioni di esercizio non deve mai venir superata la sollecitazione massima ammissibile. Ne consegue che la coppia nominale dichiarata per il giunto deve venir confrontata con una coppia di riferimento che tenga conto dei sovraccarichi dovuti al modo di agire del carico ed alle condizioni di esercizio.

La coppia di riferimento viene ottenuta moltiplicando la coppia di esercizio per una serie di fattori moltiplicativi dipendenti dalla natura del carico o dalle condizioni di temperatura ambiente.

torque values related to precise values of the torsion angle, which assumes the limit value of 5° in connection with the max. torque value.

This provides a good hint about the incremental value of the elastic curve.

The values indicated for angular and radial misalignments are the max. permissible values.

Please consider that they are limit values, not accumulable (either angular or radial compensation), which apply to "standard" working conditions, in which operating torque is not greater than rated torque, rotating speed is not less than 1450 rpm, the highest rotating speed equal to a max rim speed of 30 m/sec.

Thanks to the properties of the material employed, this speed can be reached keeping a sufficient safety margin from the danger of breakdown due to centrifugal force stress. Though each half-coupling is thoroughly machined on all outer surfaces, in case of effective operating speed exceeding 2800 rpm we recommend dynamic balancing of Class 2,5 according to ISO 1940.

## Coupling selection and dimensioning

The couplings are dimensioned according to the physical laws of mechanics and material resistance, in compliance with DIN 740 Part 2.

The coupling must be chosen basing on the greatest permissible stress, which shall never be exceeded even in the worst operating conditions.

As a consequence, the rated torque stated for the coupling must be compared with a reference torque taking into account the overloads due to load behaviour and operating conditions.

The reference torque is obtained by multiplying the operating torque by a series of multiplying factors depending on the kind of load or from ambient temperature conditions.

wie sind die Proportionalität zwischen Drehmoment und Verdrehwinkel sowie die Fähigkeit, mäßige Winkel- und Radialverlagerungen auszugleichen.

Andere bedeutsame Werte, die sich aber schwer auslegen lassen, sind Dämpfungsfaktor und Eigen- bzw. Resonanzfrequenz.

Zur Qualifizierung ihrer Kupplungen gibt SATI zulässige Drehmomentwerte an, die im Verhältnis zu gewissen Verdrehwinkelwerten stehen.

Bei max. Drehmoment ergibt sich ein maximaler Verdrehwinkel von 5°.

Das bietet wertvolle Anzeichen über den fortschreitenden Verlauf der Biegelinie.

Was die Winkel- und Radialverlagerungen angeht, werden die max. zulässige Werte angegeben, unter Berücksichtigung daß es sich um extreme, nicht kumulierbare Werte handelt (nur Winkel- oder nur Radialverlagerung), die nur für Standardbetriebsverhältnisse gelten, gekennzeichnet durch: Betriebsmoment nicht höher als Nennmoment, Drehgeschwindigkeit kleiner als 1450 Upm, die höchste Geschwindigkeit, der eine Umlaufgeschwindigkeit von 30 m/Sec. entspricht.

Diese Geschwindigkeit kann mit ausreichendem Sicherheitspielraum erreicht werden, denn die Eigenschaften des eingesetzten Werkstoffs schützen vor Bruchgefahr wegen Beanspruchung durch Zentrifugalkraft. Obwohl die Kupplungshälfte allseitig bearbeitet sind, sollte die Betriebsgeschwindigkeit 2800 Upm überschreiten, empfehlen wir dynamische Auswuchtung in der Klasse G 2,5 nach ISO 1940.

## Berechnungen zur Auswahl und Dimensionierung der Kupplungen

Die Dimensionierung der Kupplungen erfolgt laut den physischen Gesetzen der Mechanik und der Werkstoffestigkeit, und in Anlehnung an DIN 740 Teil 2.

Die Kupplung muß so dimensioniert sein, daß die zulässige Kupplungsbeanspruchung in keinem Betriebszustand überschritten wird.

Daher muß das angegebene Nennmoment der Kupp-

lement qualifiantes mais plus difficiles à interpréter sont le facteur d'amortissement et la fréquence naturelle ou de résonance.

Pour la qualification de ses accouplements, Sati S.p.A déclare des valeurs de couple de torsion admissibles reliées à des valeurs précis de l'angle de torsion qui, en cas de couple maximum, prend la valeur limite de 5°.

Ça donne un indice intéressant quant à la progressivité de la courbe élastique.

Pour les désalignements angulaire et radiaux les valeurs rapportées sont les valeurs maximales admissibles, compte tenu qu'il s'agit de valeurs extrêmes, pas cumulables (ou compensation angulaire ou compensation radiale) et valables pour des conditions de fonctionnement "standard" marquée par: couple d'exercice pas supérieur au couple nominal, vitesse de rotation au dessous de 1450 tours/min (la vitesse maximale de rotation à laquelle correspond une vitesse périphérique maximale de 30 m/sec.).

Grâce aux caractéristiques du matériau employé, cette vitesse peut être atteinte avec assez de marge de sécurité par rapport au danger de rupture causée par une contrainte due à la force centrifuge.

Bien que les deux demi-accouplements soient entièrement usinés sur chaque surface extérieure, on recommande l'équilibrage dynamique en classe G 2,5 suivant ISO 1940 lors d'une vitesse de marche dépassant 2800 tours/min.

## Principes pour la selection et le dimensionnement des accouplements

Le dimensionnement des accouplements se fait suivant les lois physiques de la mécanique et de la résistance des matériaux, en pleine conformité avec les prescriptions de la norme DIN 740 Partie 2. Pour la sélection de l'accouplement il faut se tenir au critère selon lequel, même dans la pire condition de travail, la contrainte maximale admissible ne doit jamais être dépassée.

Par conséquent le couple

desalineaciones angulares y radiales modestas. Valores igualmente calificantes, aunque de más difícil interpretación, son el factor de amortiguación y la frecuencia natural o de resonancia.

Para la clasificación de sus acoplamientos Sati S.p.A declara valores de par de torsión permitidos relacionados a valores del ángulo de torsión claramente definidos, que en correspondencia del par máximo asume su valor máximo de 5 grados.

Lo anterior proporciona una orientación válida relativamente a la progresión de la curva elástica.

Por lo que atañe las desalineaciones angular y radial aparecen indicados los valores máximos permitidos, con la advertencia que se trata de los valores extremos, no acumulables sólo compensación angular o sólo compensación radial y válidos para condiciones de empleo de tipo "estándar", caracterizadas por: par de funcionamiento no superior al par nominal, velocidad de rotación inferior a 1.450 r.p.m., la máxima velocidad de rotación a la que corresponde una velocidad periférica máxima de 30 m/seg..

Gracias a las características del material utilizado, dicha velocidad se puede alcanzar con suficiente margen de seguridad con respecto al peligro de rotura debida a la sollicitación de la fuerza centrifuga.

A pesar de que los semiacoplamientos sean completamente trabajados sobre cada superficie externa, se recomienda efectuar el equilibrado dinámico clase G 2,5 según lo establecido por la norma ISO 1.940 en caso de que la velocidad de servicio efectivo supere los 2.800 r.p.m..

## Criterios de elección y cálculo de dimensiones del acoplamiento

El cálculo de dimensiones de los acoplamientos está basado sobre las leyes físicas de la mecánica y de la resistencia de los materiales y es también conforme según lo dispuesto por la norma DIN 740 Hoja 2. Para la elección del acoplamiento es válido el criterio según el que incluso



<p><b>Simboli</b></p> <p><b>TKN</b> coppia nominale del giunto</p> <p><b>TK max</b> coppia max del giunto</p> <p><b>TKw</b> coppia con inversione del giunto</p> <p><b>TLN</b> coppia d'esercizio lato condotto</p> <p><b>TLs</b> coppia di spunto lato condotto</p> <p><b>TAs</b> coppia di spunto lato motore</p> <p><b>Ts</b> coppia di spunto dell'impianto</p> <p><b>PLn</b> potenza d'esercizio lato condotto</p> <p><b>nLn</b> velocità di rotazione lato condotto (giri 1)</p> <p><b>St</b> fattore di temperatura</p> <p><b>SA</b> fattore d'urto lato motore</p> <p><b>SL</b> fattore d'urto lato condotto</p> <p><b>Sz</b> fattore d'avviamento</p> <p><b>SmA</b> fattore di massa lato comando</p> <p><b>SmL</b> fattore di massa lato condotto</p> <p><b>Carico dovuto alla coppia nominale</b> La coppia nominale ammissibile del giunto TKN deve risultare per qualsiasi temperatura di esercizio eguale o maggiore della coppia di esercizio del lato condotto TLN TLN=9549 [Nm]</p> <p>Per tener conto dei sovraccarichi dovuti alla temperatura di esercizio del giunto, dovrà risultare soddisfatta la seguente eguaglianza dove St rappresenta il fattore di temperatura. TKN =&gt; TLN •St</p> <p><b>Carico dell'avviamento</b> Durante il transitorio di avviamento, il motore di comando eroga una coppia motrice multipla della coppia nominale e dipendente dalla distribuzione delle masse. Altrettanto si verifica in fase di frenatura per cui queste due fasi sono caratterizzate da urti di coppia la cui intensità viene a dipendere dalla distribuzione delle masse relative al</p>	<p><b>Abbreviations</b></p> <p><b>TKN</b> Rated torque</p> <p><b>TK max</b> Max. torque</p> <p><b>TKw</b> Torque with coupling reversal</p> <p><b>TLN</b> Operating torque on driven side</p> <p><b>TLs</b> Starting torque on driven side</p> <p><b>TAs</b> Starting torque on driving side</p> <p><b>Ts</b> Starting torque of the system</p> <p><b>PLn</b> Operating power on driven side</p> <p><b>nLn</b> Rotating speed on driven side (1 rotation)</p> <p><b>St</b> Temperature factor</p> <p><b>SA</b> Shock factor on driving side</p> <p><b>SL</b> Shock factor on driven side</p> <p><b>Sz</b> Starting factor</p> <p><b>SmA</b> Mass factor on driving side</p> <p><b>SmL</b> Mass factor on driven side</p> <p><b>Load due to rated torque</b> Regardless of operating temperature, the permissible rated torque of the coupling (TKN) must always be equal to or greater than operating torque on driven side (TLN) TLN=9549 [Nm]</p> <p>To take into consideration the overloads due to the coupling operating temperature, the following equation shall be met, in which St stands for temperature factor: TKN =&gt; TLN •St</p> <p><b>Load at starting</b> During starting, the driving motor delivers a driving torque multiple of rated torque and depending on the mass distribution. The same occurs at a breaking phase, so that starting and breaking are marked by torque shocks whose inten-</p>	<p>lung mit einem Bezugsdrehmoment verglichen werden, das die durch Lastverhalten und Betriebsverhältnisse bedingten Überlastungen berücksichtigt. Das Bezugsdrehmoment ergibt sich aus der Multiplikation des Betriebsdrehmoments mit gewissen von Belastungsart und Umgebungstemperaturen abhängigen Faktoren.</p> <p><b>Symbole</b></p> <p><b>TKN</b> Nenn Drehmoment</p> <p><b>TK max</b> Maximaldrehmoment</p> <p><b>TKw</b> Wechseldrehmoment</p> <p><b>TLN</b> Betriebsmoment der Lastseite</p> <p><b>TLs</b> Anlaufdrehmoment der Lastseite</p> <p><b>TAs</b> Anlaufdrehmoment der Antriebsseite</p> <p><b>Ts</b> Anlaufdrehmoment der Anlage</p> <p><b>PLn</b> Betriebsleistung der Lastseite</p> <p><b>nLn</b> Drehgeschwindigkeit der Lastseite (1 Umdrehung)</p> <p><b>St</b> Temperaturfaktor</p> <p><b>SA</b> Stoßfaktor der Antriebsseite</p> <p><b>SL</b> Stoßfaktor der Lastseite</p> <p><b>Sz</b> Anlauffaktor</p> <p><b>SmA</b> Massenfaktor der Antriebsseite</p> <p><b>SmL</b> Massenfaktor der Lastseite</p> <p><b>Belastung durch Nenn Drehmoment</b> Das zulässige Nenn Drehmoment der Kupplung TKN muß bei jeder Betriebs-temperatur gleich oder größer als das Betriebsmoment der Lastseite TLN sein. TLN=9549 [Nm]</p> <p>Zur Berücksichtigung der von Betriebstemperatur der Kupplung abhängigen Überlastungen, muß die folgende Gleichung, mit St als Temperaturfaktor, erfüllt werden: TKN =&gt; TLN •St.</p> <p><b>Belastung durch Anlauf</b> In der Anlaufphase liefert</p>	<p>nominal déclaré pour l'accouplement doit être comparé avec un couple de référence tenant compte des surcharges dues au comportement de la charge ainsi qu'aux conditions d'exercice. Le couple de référence s'obtient en multipliant le couple d'exercice par une suite de facteurs multiplicatifs qui dépendent du type de la charge ou des conditions de la température ambiante.</p> <p><b>Symboles</b></p> <p><b>TKN</b> couple nominal de l'accouplement</p> <p><b>TK max</b> couple max. de l'accouplement</p> <p><b>TKw</b> couple avec inversion de l'accouplement</p> <p><b>TLN</b> couple d'exercice côté entraîné</p> <p><b>TLs</b> couple de pointe côté entraîné</p> <p><b>TAs</b> couple crête côté entraîné</p> <p><b>Ts</b> couple crête de l'installation</p> <p><b>PLn</b> puissance d'exercice côté entraîné</p> <p><b>nLn</b> vitesse de rotation côté charge (tours 1)</p> <p><b>St</b> facteur de température</p> <p><b>SA</b> facteur de choc côté entraîné</p> <p><b>SL</b> facteur de choc côté entraîné</p> <p><b>Sz</b> facteur de démarrage</p> <p><b>SmA</b> facteur de masse côté entraîné</p> <p><b>SmL</b> facteur de masse côté charge</p> <p><b>Charge due au couple nominal</b> Le couple nominal admissible de l'accouplement TKN doit résulter pour n'importe quelle température d'exercice égal ou supérieur au couple d'exercice du côté entraîné TLN TLN=9549 [Nm]</p> <p>Pour tenir compte des surcharges survenantes à cause de la température d'exercice</p>	<p>en las condiciones de trabajo más difíciles no se tiene que superar nunca la sollicitación máxima permitida. De ello deriva que el par nominal declarado por el acoplamiento debe compararse con un par de referencia que considere las sobrecargas debidas a la forma de actuar de la carga y a las condiciones de trabajo. El par de referencia se obtiene multiplicando el par de trabajo por una serie de factores multiplicadores que dependen de la naturaleza de la carga o de las condiciones de la temperatura ambiente.</p> <p><b>Símbolos</b></p> <p><b>TKN</b> par nominal del acoplamiento</p> <p><b>TK max</b> par máximo del acoplamiento</p> <p><b>TKw</b> par con inmersión del acoplamiento</p> <p><b>TLN</b> par de trabajo lado conducido</p> <p><b>TLs</b> par de arranque lado conducido</p> <p><b>TAs</b> par de arranque lado conducción</p> <p><b>Ts</b> par de arranque del sistema</p> <p><b>PLn</b> potencia de trabajo lado conducido</p> <p><b>nLn</b> velocidad de rotación lado conducido (giros 1)</p> <p><b>St</b> factor de temperatura</p> <p><b>SA</b> factor de choque lado conducción</p> <p><b>SL</b> factor de choque lado conducido</p> <p><b>Sz</b> factor de arranque</p> <p><b>SmA</b> factor de masa lado conducción</p> <p><b>SmL</b> factor de masa lado conducido</p> <p><b>Carga debida al par nominal</b> Para cualquier temperatura de servicio el par nominal permitido del acoplamiento TKN debe ser igual o superior al par de trabajo del lado conducido TLN TLN=9549 [Nm]</p>
---	---	---	--	---

# Giunti elastici torsionali esecuzione precisa con elemento elastico Drehelastische Kupplungen in genauer Ausführung flexible couplings in precise execution with elastic element Accouplements elastiques torsionnels execution precise avec anneau elastique Acoplamientos elásticos torsionales ejecución precisa con elemento elástico

lato comando SmA ed il lato condotto SmL oltreché dalla frequenza degli avviamenti da cui viene a dipendere il fattore di avviamento Sz.

- lato comando  
 $T_s = T_{as} * S_{mA} * S_A$
- lato condotto  
 $T_s = T_{Ls} * S_{mL} * S_L$

In prima approssimazione e nel caso non sia nota la distribuzione delle masse, assumere MA e ML eguali ad 1. Per azionamenti tramite motore elettrico il fattore SA può venir assunto pari al rapporto tra coppia di spunto e coppia nominale.

### Carico dovuto ad urti di coppia

La coppia nominale ammissibile del giunto TKN max deve risultare per qualsiasi temperatura di esercizio eguale o maggiore della coppia di spunto maggiorata del fattore di temperatura St e del fattore di avviamento Sz.

$$TKN_{max} > T_s * S_t * S_z$$

Per condizioni di esercizio che prevedano variazioni periodiche o inversioni di coppia nonché sollecitazioni torsionali alternate consultare l'Ufficio Tecnico della Sati S.p.A.

sity depends on the distribution of masses related to driving side SmA and to driven side SmL, as well as by the starting frequency affecting the starting factor Sz.

- Driving side  
 $T_s = T_{as} * S_{mA} * S_A$
- Driven side  
 $T_s = T_{Ls} * S_{mL} * S_L$

To simplify, and in case the mass distribution is not known, a rough calculation can be made by considering MA and ML equal to 1.

For electric motor drives SA factor can be considered equal to the ratio between starting torque and rated torque.

### Load due to torque shocks

Regardless of operating temperature, the permissible rated torque of the coupling (TKN max) must be equal to or greater than starting torque increased by temperature factor St and by starting factor Sz.

$$TKN_{max} > T_s * S_t * S_z$$

In case of operating conditions subject to periodic changes or torque reversals as well as to alternate torsional stresses, please contact Sati's Engineering Dept.

der Antriebsmotor ein Antriebsdrehmoment vielfach vom Nennrehmoment und abhängig von Massenverteilung.

Das Gleiche ereignet sich in der Bremsphase, so daß sich beide Phasen durch Drehmomentstöße kennzeichnen, deren Stärke von Massenverteilung der Antriebsseite SmA und der Lastseite SmL, sowie von der Anlaufhäufigkeit, die den Anlauffaktor Sz bedingt, abhängig ist

- Antriebsseite  
 $T_s = T_{as} * S_{mA} * S_A$
- Lastseite  
 $T_s = T_{Ls} * S_{mL} * S_L$

Zum vereinfachen, und falls die Massenverteilung nicht bekannt ist, nehmen Sie MA und ML als gleich 1.

Für Elektromotorantriebe kann der Faktor SA als gleich dem Verhältnis zwischen Anlaufdrehmoment und Nenn-drehmoment genommen werden.

### Belastung durch Drehmomentstöße

Das zulässige Nenn-drehmoment der Kupplung TKN muß bei jeder Betriebstemperatur gleich oder größer sein als das Anlaufdrehmoment erhöht durch Temperaturfaktor St und Anlauffaktor Sz.

$$TKN_{max} > T_s * S_t * S_z$$

Im Fall von Betriebs-verhältnissen, die periodische Änderungen oder Drehmomentwechsel sowie abwechselnde Verdrehbeanspruchungen vorsehen, wenden Sie sich bitte an die technische Abteilung von Sati S.p.A.

de l'accouplement, il faudra que l'équation suivante soit satisfaite, où St représente le facteur de température.

$$TKN \Rightarrow TLN * S_t$$

### CHARGE AU DÉMARRAGE

Pendant la phase de démarrage, le moteur d'entraînement dégage un couple moteur multiple du couple nominal et dépendant de la distribution des masses, le même se vérifiant en phase de freinage. Ces deux phases sont donc caractérisées par des chocs de couple ayant une intensité résultante de la distribution des masses relatives au côté d'entraînement SmA et au côté entraîné SmL outre que de la fréquence des démarrages influant sur le facteur de démarrage Sz.

- côté d'entraînement  
 $T_s = T_{as} * S_{mA} * S_A$
- côté entraîné  
 $T_s = T_{Ls} * S_{mL} * S_L$

Pour simplifier, et si on ne connaît pas la distribution des masses, prenez MA et ML comme égaux à 1.

Pour les entraînements moyennant moteur électrique le facteur SA peut être considéré comme égal au rapport entre couple crête et couple nominal.

### Charge due à chocs de couple

Le couple nominal admissible de l'accouplement TKN max doit être pour n'importe quelle température d'exercice égal ou supérieur au couple crête majoré du facteur de température St et du facteur de démarrage Sz.

$$TKN_{max} > T_s * S_t * S_z$$

Pour des conditions d'exercice qui comportent des variations périodiques ou des inversions de couple ou des contraintes torsionnelles alternées veuillez bien contacter le Bureau Technique de Sati S.p.A.

Para tener en cuenta las sobrecargas debidas a la temperatura de servicio del acoplamiento, es necesario que la siguiente ecuación sea satisfecha, donde St representa el factor de temperatura.

$$TKN \Rightarrow TLN * S_t$$

### CARGA DE ARRANQUE

Durante el transitorio de arranque el motor de accionamiento suministra un par motor múltiple del par nominal y dependiente de la distribución de las masas. Otro tanto ocurre durante el frenado, por lo que estas dos fases están caracterizadas por choques de par cuya intensidad depende de la distribución de las masas relativas al lado conducción SmA y al lado conducido SmL, además de la frecuencia de los arranques de los que depende el factor de arranque Sz.

- lado conducción  
 $T_s = T_{as} * S_{mA} * S_A$
- lado conducido  
 $T_s = T_{Ls} * S_{mL} * S_L$

Por una primera aproximación y en el caso de que no se conozca la distribución de las masas, asumimos que MA y ML son iguales a 1.

Para arranques a través del motor eléctrico, se puede asumir que el factor SA sea equivalente a la relación existente entre el par de arranque y el par nominal.

### Carga debida a choques de par

Para cualquier temperatura de servicio el par nominal permitido del acoplamiento TKN máx. debe ser igual o superior al par de arranque incrementado por el factor de temperatura St y el factor de arranque Sz.

$$TKN_{max} > T_s * S_t * S_z$$

Para condiciones de trabajo que requieran variaciones periódicas o inversiones de par así como sollicitaciones torsionales alternas consúltese la Oficina Técnica de Sati S.p.A.

Giunti elastici torsionali esecuzione precisa  con elemento elastico

 flexible couplings in precise execution with elastic element

Drehelastische Kupplungen in genauer Ausführung  mit elastischem Zwischenglied

Accouplements elastiques torsionnels execution precise  avec anneau elastique

Acoplamientos elásticos torsionales ejecución precisa  con elemento elástico



**Valori orientativi per fattori di adeguamento**  
**Standard values for adjustment factors / Richtwerte für Anpassungsfaktoren**  
**Valeurs d'orientation pour les facteurs rajustement / Valores aproximados para los factores de ajuste**

Denominazione Designation / Bezeichnung Dénomination / Denominación	Simbolo Abbreviation / Symbol Symbole / Símbolo	Definizione / Definition / Definition / Définition / Definición				
Fattore di temperatura Temperature factor Temperaturfaktor Facteur de température Factor de temperatura	<b>St.</b>	St. °C	1 -30 +30	1.2 +40	1.4 +80	1.8 +120
Fattore di avviamento Starting factor Anlauffaktor Facteur de démarrage Factor de accionamiento	<b>Sz.</b>	Numero degli avviamenti per ora / Number of starts per hour / Anzahl der Anläufe/Stunde Nombre de démarrage/heure / Numero de arranques por hora				
		Avviamento/h. / Starts/h. / Anläufe/Stunde Démarrages/h. / Arranques / h Sz.	100 1	200 1,2	400 1,4	800 1,6
Fattore d'urto Shock factor Stoßfaktor Facteur de choc Factor de choque	<b>SA/SL</b>	Urti di avviam. leggeri / Slight starting shocks Leichte Anlaufstöße / Chocs faibles au démarrage Choques de arranque ligeros	<b>SA/SL</b> 1,5			
		Urti di avviam. medi / Medium starting shocks Mittelanlaufstöße / Chocs moyens au démarrage Choques de arranque medios	1,8			
		Urti di avviam. pesanti / Heavy starting shcks Achwere Anlaufstöße / Chocs forts au démarrage Choques de arranque fuertes	2,2			

Regime di carico Type of load Belastungsart Type de charge Régimen de carga	<b>Fattori Di Servizio / Service factors / Betriebsfaktoren / Facteurs de service / Factores de servicios</b>		
	Condizioni di impiego Operating conditions Betriebsverhältnisse Conditions de fonctionnement Condiciones de funcionamiento	Tipo di azionamento Type of prime mover Antriebsart Type d'entraînement Tipo de accionamiento	
		Motore elettr. Electric motor Elektromotore Moteur électrique Motor eléctrico	Motore Dies. Diesel engine Dieselmotore Moteur électrique Motor diésel
Uniforme Uniform Gleichmässig Uniforme Uniforme	Funzionamento regolare senza urti o sovraccarichi. Uniform operation with no shocks or overloads Gleichmäßiger Betrieb ohne Stöße oder Überlastungen Fonctionnement régulier sans chocs ni surcharges Funcionamiento regular sin choques ni sobrecargas	1,25	1,5
Leggero Light Leicht Légère Ligero	Funzionamento regolare con urti e sovraccarichi leggeri e poco frequenti Uniform operation with slight and sporadic overloads and shocks Gleichmäßiger Betrieb mit leichten gelegentlichen Überlastungen und Stößen Fonctionnement régulier avec des surcharges et des chocs légères et sporadiques Funcionamiento regular con choques y sobrecargas ligeras y esporádicas	1,5	2,0
Medio Medium Mittel Moyenne Medio	Funzionamento irregolare con sovraccarichi medi di breve durata e urti frequenti ma moderati Irregular operation with medium-intensity, short-lasting overloads and frequent, moderate shocks Ungleichmäßiger Betrieb mit kurzen Überlastungen mittlerer Stärke und häufigen, mäßigen Stößen Fonctionnement irrégulier avec de brefs surcharges de moyenne intensité et de fréquents chocs modérés. Funcionamiento irregular con breves sobrecargas de media intensidad y choques frecuentes pero moderados	2,0	2,5
Pesante Heavy Schwer Lourde Pesante	Funzionamento decisamente irregolare con urti sovraccarichi molto frequenti e di forte intensità Markedly irregular operation with frequent shocks and overloads of major intensity Entscheidend Ungleichmäßiger Betrieb mit häufigen Stößen und Überlastungen beträchtlicher Stärke Fonctionnement nettement irrégulier avec de fréquents chocs et surcharges de forte intensité Funcionamiento decididamente irregular con choques frecuentes y sobrecargas de fuerte intensidad	2,5	3,0

**Giunti elastici torsionali esecuzione precisa GG con elemento elastico**  
**GG flexible couplings in precise execution with elastic element**  
**Drehelastische Kupplungen in genauer Ausführung GG mit elastischem Zwischenglied**  
**Accouplements elastiques torsionnels execution precise GG avec anneau elastique**  
**Acoplamientos elásticos torsionales ejecución precisa GG con elemento elástico**

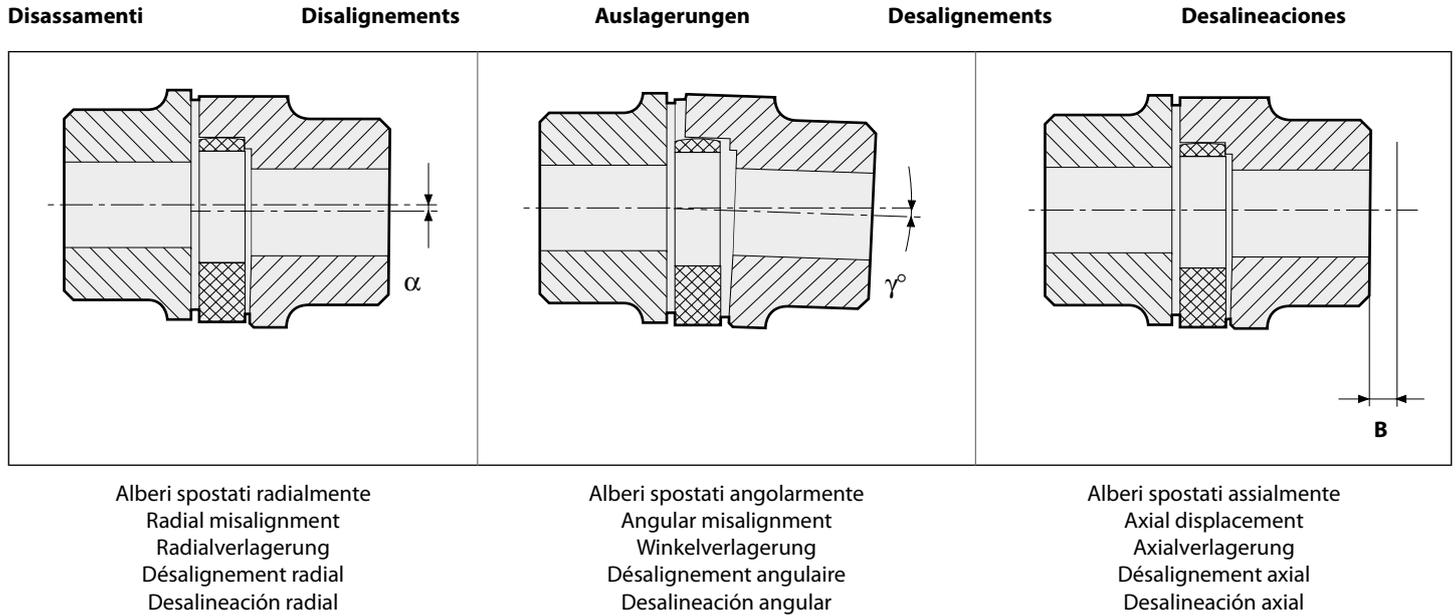

**(Stella dentata gialla in poliuretano 92 Shore A)**

**(Yellow spider in polyurethane 92 Shore A)**

**(Gelbes Zwischenglied aus Polyurethan 92 Shore A)**

**(Étoile jaune en polyurethane 92 Shore A)**

**(Estrella amarilla en poliuretano 92 Shore A)**

Dati Tecnici / Technical data / Technische Daten / Données techniques / Datos técnicos															
Tipo Type Typ Type Tipo	N. giri max Max. Rpm Max Drehzahl Tpm max r.p.m. máx.  (V=30 m/s)	Angolo di torsione Torsion angle Verdrehwinkel Angle de torsion Ángulo de torsión		Stella dentata Spider Zwischenglied Étoile Estrella dentada	Momento torcente (Nm) Torque (Nm) Drehmoment (Nm) Couple (Nm) Par de torsión (Nm)			Rigidità torsionale Torsional rigidity Drehfedersteife Rigidité torsionnelle Rigidez torsional  (kNm/rad)				Spostam. assiale Axial displacement Axialverlagerung Déplacement axial Desalineación axial	Disassamento massimo Max. Disalignment Max. Verlagerung Désalignement max. Desalineación máx.		
		TKN	TKmax TKmáx		TKN Norm.	MAX TKmax MAX TKmáx	con Invers. TKW TKW with inv. Wechseldrehm. TKW avec invers. TKW con invers.	1.0	0.75	0.5	0.25		B	Radial	Angol. Angular Winkel Angular
<b>19/24</b>	14000	3.2°	5°	92	10	20	2,6	1,28	1,05	0,80	0,47	1,2	0,20	1,2°	
<b>24/32</b>	10600			92	35	70	9,1	4,86	3,98	3,01	1,79	1,4	0,22	0,9°	
<b>28/38</b>	8500			92	95	190	25,0	10,90	8,94	6,76	4,01	1,5	0,25	0,9°	
<b>38/45</b>	7100			92	190	380	49,0	21,05	17,26	13,05	7,74	1,8	0,28	1,0°	
<b>42/55</b>	6000			92	265	530	69,0	23,74	19,47	14,72	8,73	2,0	0,32	1,0°	
<b>48/60</b>	5600			92	310	620	81,0	36,70	30,09	22,75	13,49	2,1	0,36	1,1°	
<b>55/70</b>	4750			92	410	820	107,0	50,72	41,59	31,45	18,64	2,2	0,38	1,1°	
<b>65/73</b>	4250			92	625	1250	163,0	97,13	79,65	60,22	35,70	2,6	0,42	1,2°	
<b>75/90</b>	3550			92	1280	2560	333,0	113,32	92,92	70,26	41,65	3,0	0,48	1,2°	
<b>90/100</b>	2800			92	2400	4800	624,0	190,09	155,87	117,86	69,86	3,4	0,50	1,2°	

Giunti elastici torsionali esecuzione precisa  con elemento elastico

 flexible couplings in precise execution with elastic element

Drehelastische Kupplungen in genauer Ausführung  mit elastischem Zwischenglied

Accouplements elastiques torsionnels execution precise  avec anneau elastique

Acoplamientos elásticos torsionales ejecución precisa  con elemento elástico

Disassamenti

Disalignments

Auslagerungen

Desalignments

Desalineaciones

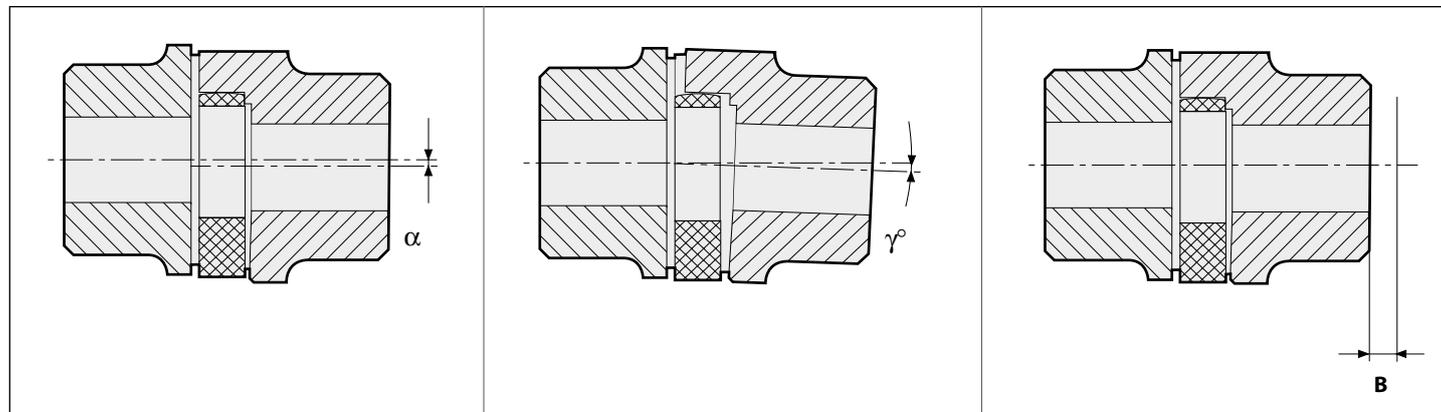

Alberi spostati radialmente  
Radial misalignment  
Radialverlagerung  
Désalignement radial  
Desalineación radial

Alberi spostati angolarmente  
Angular misalignment  
Winkelverlagerung  
Désalignement angulaire  
Desalineación angular

Alberi spostati assialmente  
Axial displacement  
Axialverlagerung  
Désalignement axial  
Desalineación axial

(Stella dentata nera in poliuretano 94 Shore A)

(Black spider in polyurethane 94 Shore A)

(Schwarzes Zwischenglied aus Polyurethan 94 Shore A)

(Étoile noire en polyurethane 94 Shore A)

(Estrella negra en poliuretano 94 Shore A)

Dati Tecnici / Technical data / Technische Daten / Données techniques / Datos técnicos

Tipo Type Typ Type Tipo	N. giri max Max. Rpm Max Drehzahl Tpm max r.p.m. máx.  (V=30 m/s)	Angolo di torsione Torsion angle Verdrehwinkel Angle de torsion Ángulo de torsión		Stella dentata Spider Zwischenglied Étoile Estrella dentada	Momento torcente (Nm) Torque (Nm) Drehmoment (Nm) Couple (Nm) Par de torsión (Nm)			Rigidità torsionale Torsional rigidity Drehfedersteife Rigidité torsionnelle Rigidez torsional  (kNm/rad)				Spostam. assiale Axial displacement Axialverlagerung Déplacement axial Desalineación axial	Disassamento massimo Max. Disalignment Max. Verlagerung Désalignement max. Desalineación máx.		
		TKN	TKmax TKmáx		TKN Norm.	MAX TKmax MAX TKmáx	con Invers. TKW TKW with inv. Wechseldrehm. TKW avec invers. TKW con invers.	1.0	0.75	0.5	0.25		B	Radial	Angol. Angular Winkel Angul Angular
19/24	14000	3.2°	5°	94	12	24	3,2	1,82	1,49	1,13	0,67	1,2	0,20	1,2°	
24/32	10600			94	43	86	11,4	6,55	5,36	4,06	2,41	1,4	0,22	0,9°	
28/38	8500			94	126	233	30,6	16,19	13,27	10,04	5,95	1,5	0,25	0,9°	
38/45	7100			94	235	470	61,0	30,22	24,78	18,73	11,11	1,8	0,28	1,0°	
42/55	6000			94	326	653	85,0	33,99	27,87	21,07	12,49	2,0	0,32	1,0°	
48/60	5600			94	381	763	99,7	46,23	37,90	28,64	16,99	2,1	0,36	1,1°	
55/70	4750			94	500	1003	130,7	65,47	53,68	40,59	24,06	2,2	0,38	1,1°	
65/73	4250			94	730	1460	190,0	107,92	88,50	66,91	39,66	2,6	0,42	1,2°	
75/90	3550			94	1493	2986	388,3	141,38	115,93	87,65	51,96	3,0	0,48	1,2°	
90/100	2800			94	2800	5600	728,0	230,79	189,24	143,09	84,81	3,4	0,50	1,2°	

**Giunti elastici torsionali esecuzione precisa GG con elemento elastico**  
**GG flexible couplings in precise execution with elastic element**  
**Drehelastische Kupplungen in genauer Ausführung GG mit elastischem Zwischenglied**  
**Accouplements elastiques torsionnels execution precise GG avec anneau elastique**  
**Acoplamiento elásticos torsionales ejecución precisa GG con elemento elástico**

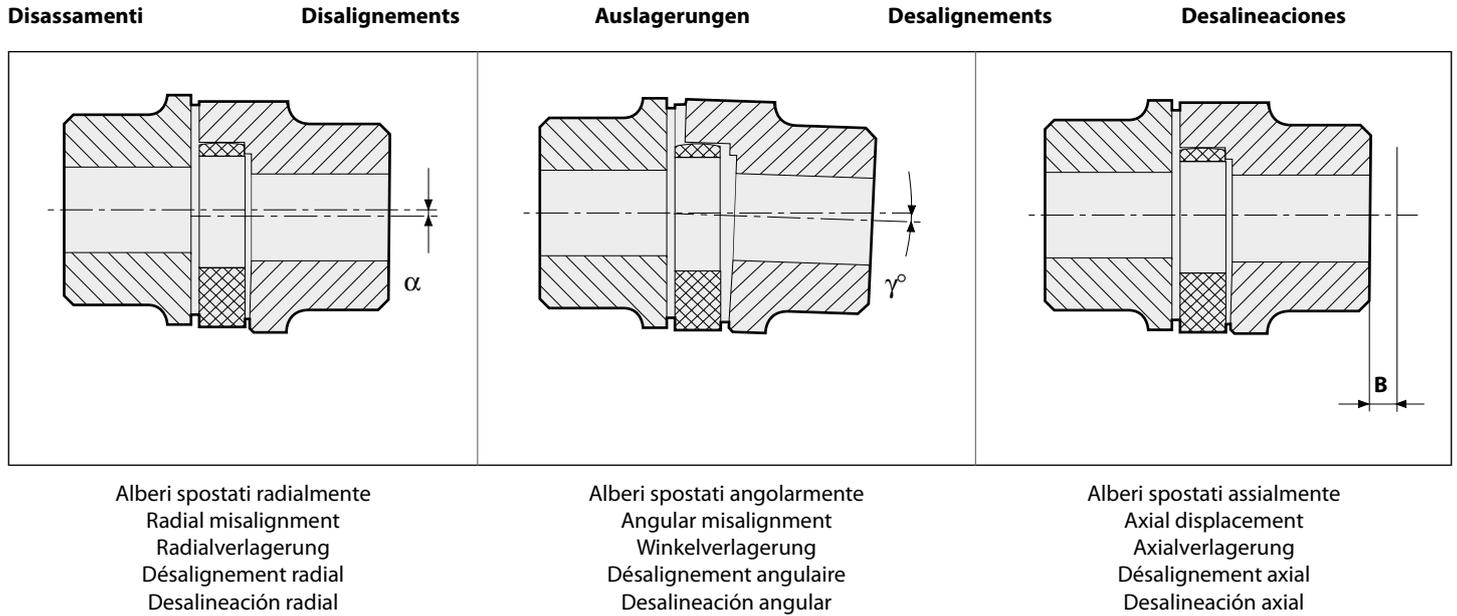

**(Stella dentata rossa in poliuretano 98 Shore A)**

**(Red spider in polyurethane 98 Shore A)**

**(Rotes Zwischenglied aus Polyurethan 98 Shore A)**

**(Étoile rouge en polyurethane 98 Shore A)**

**(Estrella roja en poliuretano 98 Shore A)**

Dati Tecnici / Technical data / Technische Daten / Données techniques / Datos técnicos															
Tipo Type Typ Type Tipo	N. giri max Max. Rpm Max Drehzahl Tpm max r.p.m. máx.  (V=30 m/s)	Angolo di torsione Torsion angle Verdrehwinkel Angle de torsion Ángulo de torsión		Stella dentata Spider Zwischenglied Étoile Estrella dentada	Momento torcente (Nm) Torque (Nm) Drehmoment (Nm) Couple (Nm) Par de torsión (Nm)			Rigidità torsionale Torsional rigidity Drehfedersteife Rigidité torsionnelle Rigidez torsional  (kNm/rad)				Spostam. assiale Axial displacement Axialverlagerung Déplacement axial Desalineación axial	Disassamento massimo Max. Disalignment Max. Verlagerung Désalignement max. Desalineación máx.		
		TKN	TKmax TKmáx		TKN Norm.	MAX TKmax MAX TKmáx	con Invers. TKW TKW with inv. Wechseldrehm. TKW avec invers. TKW con invers.	1.0	0.75	0.5	0.25		B	Radial	Angol. Angular Winkel Angular
<b>19/24</b>	14000	3.2°	5°	98	17	34	4,4	2,92	2,39	1,81	1,07	1,2	0,20	1,2°	
<b>24/32</b>	10600			98	60	120	16,0	9,93	8,14	6,16	3,65	1,4	0,22	0,9°	
<b>28/38</b>	8500			98	160	320	42,0	26,77	21,95	16,60	9,84	1,5	0,25	0,9°	
<b>38/45</b>	7100			98	325	650	85,0	48,57	39,83	30,11	17,85	1,8	0,28	1,0°	
<b>42/55</b>	6000			98	450	900	117,0	54,50	44,69	33,79	20,03	2,0	0,32	1,0°	
<b>48/60</b>	5600			98	525	1050	137,0	65,29	53,54	40,48	24,00	2,1	0,36	1,1°	
<b>55/70</b>	4750			98	685	1370	178,0	94,97	77,88	58,88	34,90	2,2	0,38	1,1°	
<b>65/73</b>	4250			98	940	1880	244,0	129,51	106,20	80,30	47,60	2,6	0,42	1,2°	
<b>75/90</b>	3550			98	1920	3840	499,0	197,50	161,95	122,45	72,58	3,0	0,48	1,2°	
<b>90/100</b>	2800			98	3600	7200	936,0	312,20	256,00	193,56	114,73	3,4	0,50	1,2°	

**Giunti elastici torsionali**   
**Torsional flexible couplings**   
**Drehelastische Kupplungen**   
**Accouplements elastiques torsionnels**   
**Acoplamientos elásticos torsionales** 

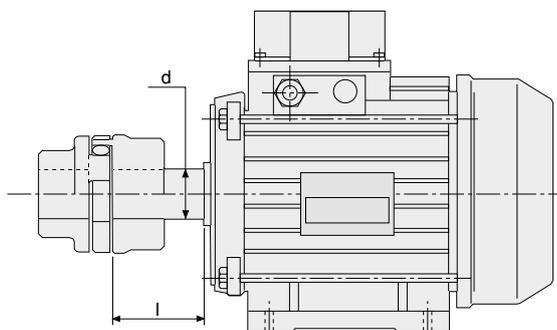

**Giunti**  **per motori normalizzati CEI**

**GG-t couplings designed for IEC standardized motors**

**GG Kupplungen für Motore nach IEC-Normen / Accouplements**

**GG pour moteurs normalisés CEI**

**Acoplamientos GG para motores normalizados CEI**

**(Stella dentata gialla in poliuretano 92 Shore A)**

**(Yellow spider in polyurethane 92 Shore A)**

**(Gelbes Zwischenglied aus Polyurethan 92 Shore A)**

**(Étoile jaune en polyurethane 92 Shore A)**

**(Estrella amarilla en poliuretano 92 Shore A)**

Motore elettrico tipo Electric motor type Typ des Elektromotors Moteur électrique Motor eléctrico	Potenza motore a 50 Hz n=3000 min. Motor Output at 50 Hz n=3000 min. Motorleistung bei 50 Hz n=3000 min. Puissance moteur à 50 Hz n=3000 min. Potencia motor a 50 Hz n=3000 min.		Giunto Coupling Kupplung Accouplement Acoplamiento		Potenza motore a 50 Hz n=1500 min. Motor Output at 50 Hz n=1500 min. Motorleistung bei 50 Hz n=1500 min. Puissance moteur à 50 Hz n=1500 min. Potencia motor a 50 Hz n=1500 min.		Giunto Coupling Kupplung Accouplement Acoplamiento		Potenza motore a 50 Hz n=1000 min. Motor Output at 50 Hz n=1000 min. Motorleistung bei 50 Hz n=1000 min. Puissance moteur à 50 Hz n=1000 min. Potencia motor a 50 Hz n=1000 min.		Giunto Coupling Kupplung Accouplement Acoplamiento		Potenza motore a 50 Hz n=750 min. Motor Output at 50 Hz n=750 min. Motorleistung bei 50 Hz n=750 min. Puissance moteur à 50 Hz n=750 min. Potencia motor a 50 Hz n=750 min.		Giunto Coupling Kupplung Accouplement Acoplamiento		Estremità d'albero dx l (mm) Shaft end dx l (mm) Wellenende dx l (mm) Bout d'arbre dx l (mm) Extremos eje dx l (mm)
	P (kW)	T (Nm)	GET-T TIPO	Fs	P (kW)	T (Nm)	GET-T TIPO	Fs	P (kW)	T (Nm)	GET-T TIPO	Fs	P (kW)	T (Nm)	GET-T TIPO	Fs	
80	0,75	2,4		8,0	0,55	3,6		5,4	0,37	3,6	19/24	5,1	0,18	2,3	19/24	8,0	19x40
90 S	1,10	3,6	19/24	5,4	0,75	4,9	19/24	3,9	0,55	5,4		3,4	0,25	3,2		5,7	
90 L	1,50	4,9		4,0	1,10	7,6		2,7	0,75	7,3		2,5	0,37	4,8		3,8	24x50
100 L	2,20	7,2		2,7	1,50	9,8		2,0	1,10	10,8		5,8	0,55	7,2		2,5	
112 M	3,00	9,8		7,1	2,20	14,4		4,7	1,50	14,7		4,7				6,4	
132 S	4,00	13,1	28/32	3,00	19,6	24/32	3,5				24/32		1,10	14,4	24/32	4,4	28x60
132 M	5,50	18,0		5,4	4,00	26,2		2,6	2,20	21,6		3,2	1,50	19,7		3,3	
160 M	7,50	24,6		10,6	5,50	36,0		5,3	3,00	29,5		6,3	2,20	28,8		6,6	
180 M			24/38	7,6					4,00	39,0		4,8			28/38		38x80
200 L					7,50	49,0		3,9					3,00	39,0		4,8	
225 S	11,00	36,0		10,6				5,50	54,0			3,5	4,00	52,0		7,0	
250 M	15,00	49,0		11,00	72,0		5,3	7,50	73,0		5,1						
280 M	18,50	60,0	38/45	7,8	15,00	98,0	38/45	3,9	11,00	108,0	38/45	3,5	7,50	98,0	38/45	5,1	42x110
315 S	22,00	72,0		6,3	18,50	121,0		4,4					5,50	72,0		3,8	
355 L	30,00	98,0		7,5	22,00	144,0		3,7	15,00	147,0		3,6	11,00	144,0		3,7	48x110
400 L				5,5			42/55		18,50	182,0	42/55	2,9			42/55		
450 L	37,00	121,0	42/55	4,4	30,00	196,0		2,7					15,00	197,0		2,7	55x110
500 L									22,00	216,0		2,5					
560 M					37,00	242,0	48/60	2,6			48/60		18,50	242,0	48/60	2,5	
630 M	45,00	147,0		3,7	45,00	295,0		2,1	30,00	295,0		2,1	22,00	288,0		2,1	55x110 60x140
710 M	55,00	180,0	48/60	3,5	55,00	360,0	55/70	2,1	37,0	364,0	55/70	2,1	30,00	394,0	65	2,2	60x140 65x140
800 M	75,00	246,0		3,1	75,00	492,0		4,0	45,00	442,0		4,4	37,00	485,0		4,0	75x140
900 M	90,00	295,0	55/70	2,6	90,00	590,0	75	3,4	55,00	541,0	75	3,6	45,00	591,0	75	3,3	
1000 M	110,00	360,0		2,1	110,00	721,0		2,8	75,00	738,0		2,7	55,00	722,0	75/90	2,7	
1120 M	132,00	433,0		4,6	132,00	866,0	75/90	2,3	90,00	885,0	75/90	2,3					65x140 80x170
1250 M	160,00	525,0		3,8	160,00	1030,0		4,7	110,00	1070,0		4,5	90,00	1170,0		4,1	
1400 M			75/90				90				90				90		
1600 M	200,00	656,0		3,0	200,00	1290,0		3,7	132,00	1280,0		3,8	110,00	1420,0		3,4	
1800 M	250,00	820,0		2,4	250,00	1610,0		3,0	160,00	1550,0	90/100	3,1	132,00	1710,0	70/100	2,8	
2000 M							90/100	2,4	200,00	1930,0		2,5	160,00	2070,0		3,2	75x140 95x170
2250 M	315,00	1010,0		4,8	315,00	2020,0			250,00	2420,0	100	2,7	200,00	2580,0	100	2,6	
2500 M	355,00	1140,0		4,2	355,00	2280,0		2,9									
2800 M			90/100	3,8			100		315,00	3040,0							80x170 100x210
3150 M	400,00	1280,0			400,00	2560,0		2,6									

# Giunti elastici torsionali **SG-M** con mozzo pieno Torsional flexible couplings **SG-M** with solid hub Drehelastische Kupplungen **SG-M** mit Vollnabe Accouplements élastiques torsionnels **SG-M** à moyeu plein Acoplamientos elásticos torsionales **SG-M** con cubo pleno

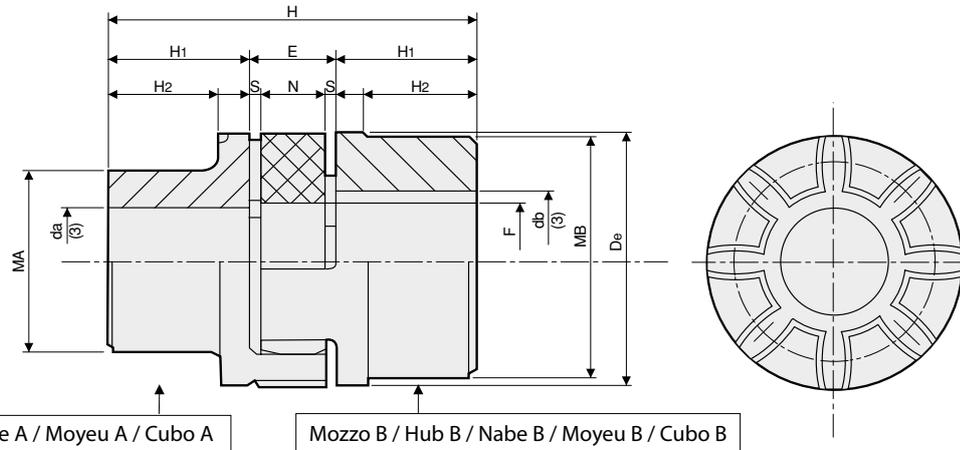

### Esempio codifica

SG-M 19A-24B = con mozzo A + mozzo B  
 SG-M 19A-19A = con due mozzi A  
 SG-M 24B-24B = con due mozzi B

### Code explanation example

SG-M 19A-24B = with hub A + hub B  
 SG-M 19A-19A = with 2 hubs A type  
 SG-M 24B-24B = with 2 hubs B type

### Kodierungsbeispiel

SG-M 19A-24B = mit nabe A + nabe B  
 SG-M 19A-19A = mit 2 Naben A  
 SG-M 24B-24B = mit 2 Naben B

### Interpretation du code

SG-M 19A-24B = avec moyeu A + moyeu B  
 SG-M 19A-19A = avec 2 moyeux A  
 SG-M 24B-24B = avec 2 moyeux B

### Ejemplo de codificación

SG-M 19A-24B = con cubo A + cubo B  
 SG-M 19A-19A = con 2 cubos A  
 SG-M 24B-24B = con 2 cubos B

Il diametro del foro (min-max) identifica la dimensione caratteristica del giunto.

The bore diameter (min-max) identifies the main size of the coupling.

Der Nabendurchmesser ((min-max) kennzeichnet die Kupplungshauptgröße.

Le diamètre de l'alésage (min-max) marque la taille caractéristique de l'accouplement.

El diámetro del agujero (min-max) identifica el tamaño característico del acoplamiento.

### Materiale ghisa EN-GJL-250 UNI EN 1561

### Material cast iron EN-GJL-250 UNI EN 1561

### Werkstoff Grauguss EN-GJL-250 UNI EN 1561

### Matière fonte EN-GJL-250 UNI EN 1561

### Material hierro fundido EN-GJL-250 UNI EN 1561

Tipo Type Typ Type Tipo	Dimensioni / Dimensions / Abmessungen Dimensions / Dimensiones [mm]														Elemento elastico Spider Zwischenglied Annea élastique Elemento elástico	Kg		(2) J kg. cm <sup>2</sup> Hub B <sub>1</sub>
	Preforo Pilot bore Vorbohrung Préalésage Taladro previo		(3) Foro Bore Bohrung Alésage Agujero		H <sub>1</sub>	De	(1) E	F	MA	MB	N	H <sub>2</sub>	S	H		A	B	
	A	B	da max	db max														
<b>SG-M 19A-24B*</b>	6	6	19	24	25	40	16	18	30	40	12	19,0	2,0	66	0,004	0,18	0,25	0,8
<b>SG-M 24A-32B</b>	9	9	24	32	30	55	18	27	40	55	14	24,0	2,0	78	0,014	0,36	0,55	3,0
<b>SG-M 28A-38B</b>	10	10	28	38	35	65	20	30	48	65	15	27,5	2,5	90	0,025	0,60	0,85	7,0
<b>SG-M 38A-45B</b>	12	12	38	45	45	80	24	38	66	78	18	36,5	3,0	114	0,042	1,35	1,65	20,0
<b>SG-M 42A-55B</b>	12	12	42	55	50	95	26	46	75	94	20	40,0	3,0	126	0,066	2,00	2,30	50,0
<b>SG-M 48A-60B</b>	12	12	48	60	56	105	28	51	85	104	21	45,0	3,5	140	0,088	2,75	3,10	80,0
<b>SG-M 55A-70B</b>	15	15	55	70	65	120	30	60	98	118	22	52,0	4,0	160	0,116	4,20	4,50	160,0
<b>SG-M 65A-75B</b>	15	15	65	75	75	135	35	68	115	134	26	61,0	4,5	185	0,172	6,50	6,80	310,0
<b>SG-M 75A-90B</b>	15	15	75	90	85	160	40	80	135	158	30	69,0	5,0	210	0,325	10,00	10,80	680,0
<b>SG-M 90A-100B</b>	38	38	90	100	100	200	45	100	160	180	34	81,0	5,5	245	0,440	14,00	15,80	1590,0

\* Acciaio  
 (1) Quote di montaggio  
 (2) Momento d'inerzia giunto con mozzi A/B e ø foro max  
 (3) A richiesta: Foro finito secondo le norme ISO, tolleranza H7 - chiave DIN 6885, tolleranza JS9. Foro per grano.

\*Steel  
 (1) Assembly distances  
 (2) Coupling moment of inertia with A/B hubs and max bore ø  
 (3) On request: Finished bore in compliance with ISO standards, H7 tolerance - keyway to DIN 6885, JS9 tolerance. Bore for screws.

\*Stahl  
 (1) Montageabmessungen  
 (2) Kupplungsträgheitsmoment mit A/B Naben und max. Bohrungsdurchm.  
 (3) Nach Wunsch: Fertigtbohrung nach ISO Normen, Toleranz H7 - Paßfedernut nach DIN 6885, Toleranz JS9. Gewindebohrung.

\*Acier  
 (1) Dimensions de montage  
 (2) Moment d'inertie accouplement avec moyeux A/B et ø alésage max.  
 (3) Sur demande: Alésage fini selon normes ISO, tolérance H7 - Rainure de clavette à DIN 6885, tolérance JS9. Trou taraudé.

\*Acero  
 (1) Cotas de montaje  
 (2) Momento de inercia acoplamiento con cubos A/B y ø agujero max.  
 (3) Bajo solicitud: eje acabado según las normas ISO tolerancia H7 clavetero Din 6885 tolerancia JS9 eji con prisionero



**Giunti elastici torsionali SG-M con mozzo pieno**  
**Torsional flexible couplings SG-M with solid hub**  
**Drehelastische Kupplungen SG-M mit Vollnabe**  
**Accouplements élastiques torsionnels SG-M à moyeu plein**  
**Acoplamientos elásticos torsionales SG-M con cubo pleno**

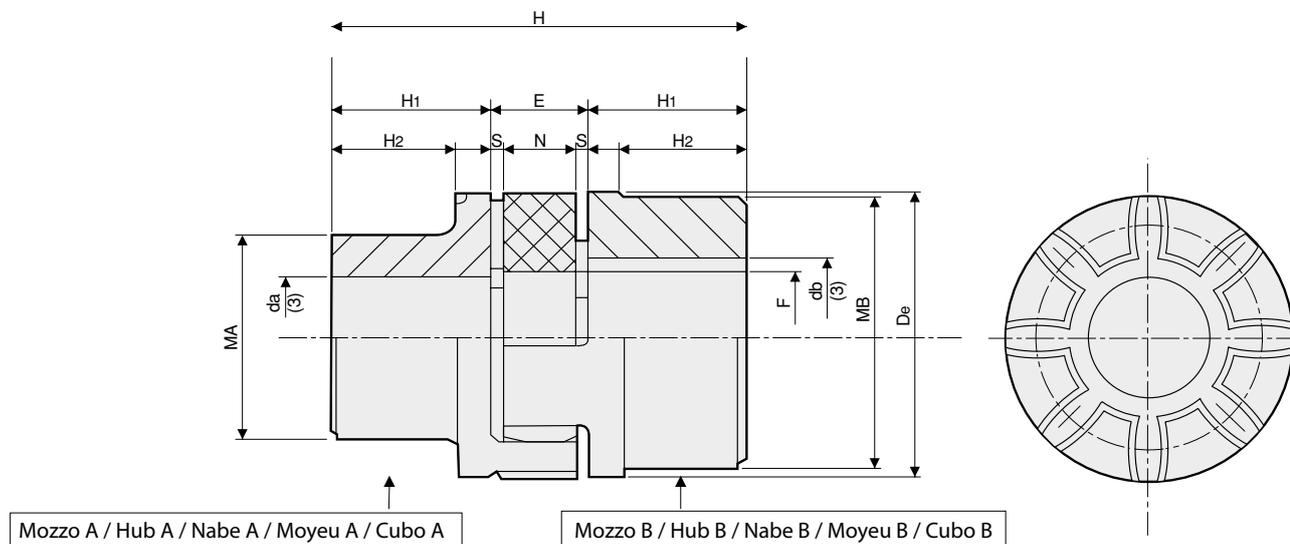

<p><b>Esempio codifica</b>          SG-M 19A-24B = con mozzo A + mozzo B          SG-M 19A-19A = con due mozzi A          SG-M 24B-24B = con due mozzi B</p>	<p><b>Code explanation example</b>          SG-M 19A-24B = with hub A + hub B          SG-M 19A-19A = with 2 hubs A type          SG-M 24B-24B = with 2 hubs B type</p>	<p><b>Kodierungsbeispiel</b>          SG-M 19A-24B = mit Nabe A + Nabe B          SG-M 19A-19A = mit 2 Naben A          SG-M 24B-24B = mit 2 Naben B</p>	<p><b>Interpretation du code</b>          SG-M 19A-24B = avec moyeu A + moyeu B          SG-M 19A-19A = avec 2 moyeux A          SG-M 24B-24B = avec 2 moyeux B</p>	<p><b>Ejemplo de codificación</b>          SG-M 19A-24B = con cubo A + cubo B          SG-M 19A-19A = con 2 cubos A          SG-M 24B-24B = con 2 cubos B</p>
<p>Il diametro del foro (min-max) identifica la dimensione caratteristica del giunto.</p>	<p>The bore diameter (min-max) identifies the main size of the coupling.</p>	<p>Der Nabendurchmesser ((min-max) kennzeichnet die Kupplungshauptgröße.</p>	<p>Le diamètre de l'alésage (min-max) marque la taille caractéristique de l'accouplement.</p>	<p>El diámetro del agujero (min-max) identifica el tamaño característico del acoplamiento</p>

**Materiale alluminio    Material aluminium    Werkstoff Aluminium    Matière aluminium    Material aluminio**

Tipo Type Typ Type Tipo	Preforo Pilot bore Vorbohrung Préalésage Taladro previo		(3)		Dimensioni / Dimensions / Abmessungen Dimensions / Dimensiones [mm]										Elemento elastico Spider Zwischenglied Anneau élastique Elemento elástico	Kg		(2) J kg. cm <sup>2</sup> Hub B <sub>1</sub>
			Foro Bore Bohrung Alésage Agujero		H <sub>1</sub>	De	(1) E	F	MA	MB	N	H <sub>2</sub>	S	H		A	B	
			da max	db max														
<b>SG-M 19A-24B/AL</b>	6	6	19	24	25	40	16	18	30	40	12	19,0	2,0	66	0,005	0,07	0,08	0,4
<b>SG-M 24A-32B/AL</b>	9	9	24	32	30	55	18	27	40	55	14	24,0	2,0	78	0,014	0,13	0,18	1,0
<b>SG-M 28A-38B/AL</b>	10	10	28	38	35	65	20	30	48	65	15	27,5	2,5	90	0,025	0,22	0,30	3,0
<b>SG-M 38A-45B/AL</b>	12	12	38	45	45	80	24	38	66	78	18	36,5	3,0	114	0,042	0,48	0,55	8,0

<p>(1) Quote di montaggio          (2) Momento d'inerzia giunto con mozzi A/B e ø foro max          (3) A richiesta: Foro finito secondo le norme ISO, tolleranza H7 – chiave DIN 6885, tolleranza JS9. Foro per grano.</p>	<p>(1) Assembly distances          (2) Coupling moment of inertia with A/B hubs and max bore ø          (3) On request: Finished bore in compliance with ISO standards, H7 tolerance - keyway to DIN 6885, JS9 tolerance. Bore for screws.</p>	<p>(1) Montageabmessungen          (2) Kupplungsträgheitsmoment mit A/B Naben und max. Bohrungsdurchm.          (3) Nach Wunsch: Fertigungsbore nach ISO Normen, Toleranz H7 – Paßfedernut nach DIN 6885, Toleranz JS9. Gewindebohrung.</p>	<p>(1) Dimensions de montage          (2) Moment d'inertie accouplement avec moyeux A/B et ø alésage max.          (3) Sur demande: Alésage fini selon normes ISO, tolérance H7 – Rainure de clavette à DIN 6885, tolérance JS9. Trou taraudé.</p>	<p>(1) Cotas de montaje          (2) Momento de inercia acoplamiento con cubos A/B y ø agujero max.          (3) Bajo solicitud: eje acabado según las normas ISO tolerancia H7 clavetero DIN 6885 tolerancia JS9 eji con prisonero</p>
---	--	---	--	---

**Materiale ghisa**
**Material cast iron**
**Werkstoff Grauguss**
**Matière fonte**
**Material Hierro fundido**

**Semigiunto mozzo A**  
**Semi - coupling hub A**  
**Halbkupplung Nabe A**  
**Demi - accouplement moyeu A**  
**Semiacoplamiento cubo A**



**Semigiunto mozzo B**  
**Semi - coupling hub B**  
**Halbkupplung Nabe B**  
**Demi - accouplement moyeu B**  
**Semiacoplamiento cubo B**

tipo / type / tipo / type / tipo  
**EN-GJL-250 UNI EN 1561**

	<b>A</b>	<b>B</b>
<b>Nostro codice</b>	SGMAA19*	SGMBA24*
<b>Our code</b>	SGMA019	SGMB024
<b>Unser Code</b>	SGMA024	SGMB032
<b>Notre code</b>	SGMA028	SGMB038
<b>Nuestro código</b>	SGMA038	SGMB045
	SGMA042	SGMB055
	SGMA048	SGMB060
	SGMA055	SGMB070
	SGMA065	SGMB075
	SGMA075	SGMB090
	SGMA090	SGMB100

\*Acciaio / Steel / Stahl / Acier / Acero

**Materiale alluminio**
**Material aluminium**
**Werkstoff Aluminium**
**Matière aluminium**
**Material aluminio**

**Semigiunto mozzo A**  
**Semi - coupling hub A**  
**Halbkupplung Nabe A**  
**Demi - accouplement moyeu A**  
**Semiacoplamiento cubo A**



**Semigiunto mozzo B**  
**Semi - coupling hub B**  
**Halbkupplung Nabe B**  
**Demi - accouplement moyeu B**  
**Semiacoplamiento cubo B**

	<b>A</b>	<b>B</b>
<b>Nostro codice</b>	SGAA019	SGAB024
<b>Our code</b>	SGAA024	SGAB032
<b>Unser Code</b>	SGAA028	SGAB038
<b>Notre code</b>	SGAA038	SGAB045
<b>Nuestro código</b>		

**Elemento elastico nero / Black spider**  
**Schwarzes Zwischenglied / Etoile noire**  
**Elemento elástico negro**

**94 Shore A**

<b>Nostro codice / Our code</b> <b>Unser Code / Notre code</b> <b>Nuestro código</b>	EN19024	EN48060
	EN24032	EN55070
	EN28038	EN65075
	EN38045	EN75090
	EN42055	EN90100

**Elemento elastico giallo / Yellow spider**  
**Gelbes Zwischenglied / Etoile jaune**  
**Elemento elástico amarillo**

**92 Shore A**

<b>Nostro codice</b> <b>Our code</b> <b>Unser Code</b> <b>Notre code</b> <b>Nuestro código</b>	EG19024
	EG24032
	EG28038
	EG38045
	EG42055
	EG48060
	EG55070
	EG65075
	EG75090
	EG90100

**Elemento elastico rosso / Red spider**  
**Rotes Zwischenglied / Etoile rouge**  
**Elemento elástico rojo**

**98 Shore A**

<b>Nostro codice / Our code</b> <b>Unser Code / Notre code</b> <b>Nuestro código</b>	ER19024	ER48060
	ER24032	ER55070
	ER28038	ER65075
	ER38045	ER75090
	ER42055	ER90100

**Giunti elastici SG-T per bussole coniche**  
**Torsional flexible couplings SG-T for taper bushes**  
**Drehelastische Kupplungen SG-T für Spannbuchsen**  
**Accouplements élastiques torsionnels SG-T pour moyeux amovibles**  
**Acoplamiento elástico torsional SG-T para bujes conicos**

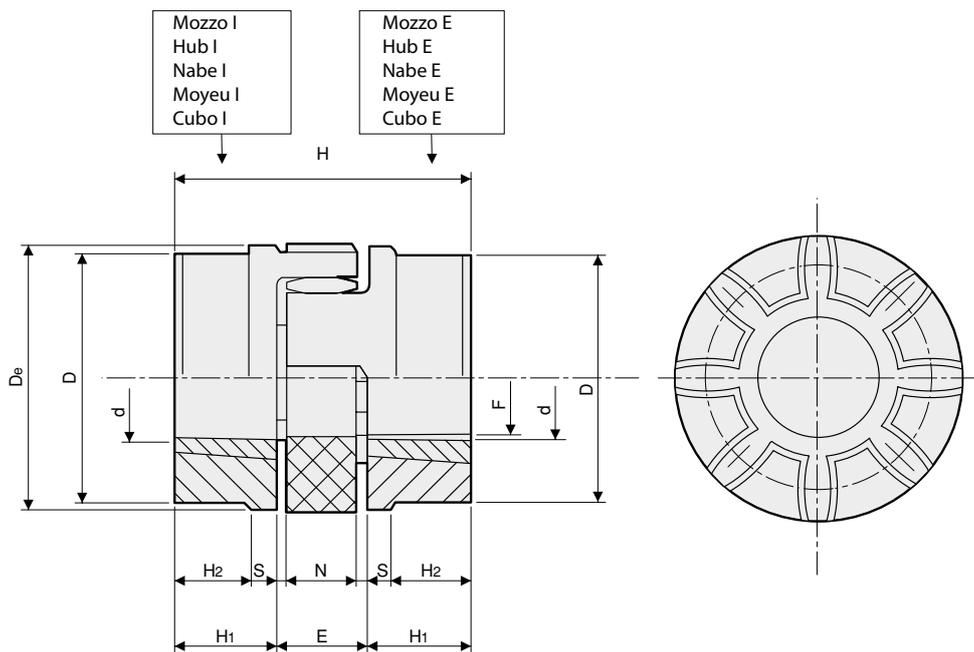

**Esempio codifica**

SG-T 28-38I / 28-38E = con mozzo I + mozzo E  
 SG-T 28-38I / 28-38I = con due mozzi I  
 SG-T 28-38E / 28-38E = con due mozzi E

E = mozzo con bussola esterna  
 I = mozzo con bussola interna

**Code explanation example**

SG-T 28-38I / 28-38E = with hub I + hub E  
 SG-T 28-38I / 28-38I = with 2 hubs I type  
 SG-T 28-38E / 28-38E = with 2 hubs E type

E = hub with large taper end  
 I = hub with small taper end

**Kodierungsbeispiel**

SG-T 28-38I / 28-38E = mit Nabe I + Nabe E  
 SG-T 28-38I / 28-38I = mit 2 Naben I  
 SG-T 28-38E / 28-38E = mit 2 Naben E

E = Nabe mit Außenbuchse  
 I = Nabe mit Innenbuchse

**Interpretation du code**

SG-T 28-38I / 28-38E = avec moyeu I + moyeu E  
 SG-T 28-38I / 28-38I = avec 2 moyeux I  
 SG-T 28-38E / 28-38E = avec 2 moyeux E

E = moyeu avec douille extérieure  
 I = moyeu avec douille intérieure

**Ejemplo de codificación**

SG-T 28-38I / 28-38E = con cubo I + cubo E  
 SG-T 28-38I / 28-38I = con 2 cubos I  
 SG-T 28-38E / 28-38E = con 2 cubos E

E = cubo con buje exterior  
 I = cubo con buje interior

**Materiale ghisa**  
**EN-GJL-250 UNI EN 1561**

**Material cast iron EN-GJL-250 UNI EN 1561**

**Werkstoff Grauguss**  
**EN-GJL-250 UNI EN 1561**

**Matière fonte**  
**EN-GJL-250 UNI EN 1561**

**Material hierro fundido**  
**EN-GJL-250 UNI EN 1561**

Tipo Type Typ Type Tipo	Foro Bore Bohrung Alésage Agujero		Bussola Bush Buchse Douille Buje	Dimensioni / Dimensions / Abmessungen Dimensions / Dimensiones [mm]										Elemento elastico Spider Zwischenglied Anneau élastique Elemento elástico	Mozzi I/E foro max Max bore for hubs I/E Max. I/E Nabenbohrung Alésage max. moyeux I/E Agujero max. cubos I/E	(2) J kg. cm <sup>2</sup> Hub B <sub>1</sub>
	d min	d max		H <sub>1</sub>	De	(1) E	F	D	N	S	H	H <sub>2</sub>				
<b>SGT-T 28-38 TL</b>	9	28	1108	23	65	20	30	65	15	2,5	66	–	0,025	0,50	7	
<b>SGT-T 38-45 TL</b>	9	28	1108	23	80	24	38	78	18	3,0	70	15	0,042	0,88	26	
<b>SGT-T 42-55 TL</b>	10	42	1610	26	95	26	46	94	20	3,0	78	16	0,066	1,40	36	
<b>SGT-T 48-60 TL</b>	10	42	1615	39	105	28	51	104	21	3,5	106	28	0,088	2,33	78	
<b>SGT-T 55-70 TL</b>	12	50	2012	33	120	30	60	118	22	4,0	96	20	0,116	2,42	120	
<b>SGT-T 75-90 TL</b>	16	60	2517	52	160	40	80	158	30	5,0	144	36	0,325	6,80	630	

(1) Quote di montaggio  
 (2) Momento d'inerzia giunto con mozzi I/E e ø foro max

(1) Assembly distances  
 (2) Coupling moment of inertia with I/E hubs and max bore ø

(1) Montageabmessungen  
 (2) Kupplungsträgheitsmoment mit I/E Naben und max. Bohrungsdurchm.

(1) Dimensions de montage  
 (2) Moment d'inertie accouplement avec moyeux I/E et ø alésage max.

(1) Cotas de montaje  
 (2) Momento de inercia acoplamiento con cubos I/E y ø agujero max.

**Semigiunto bussola  
conica I**

**Semi - coupling taper  
bored I**

**Halbkupplung  
Spannbuchse I**

**Demi - accouplement  
moyeu amovible I**

**Semiacoplamiento  
casquillo conico I**



<b>Nostro codice</b> <b>Our code</b> <b>Unser Code</b> <b>Notre code</b> <b>Nuestro código</b>	GTI2838	<b>Bussola</b> <b>Bush</b> <b>Buchse</b> <b>Douille</b> <b>Buje</b>	1108
	GTI3845		1108
	GTI4255		1610
	GTI4860		1615
	GTI5570		2012
GTI7590	2517		

**Semigiunto bussola  
conica E**

**Semi - coupling taper  
bored E**

**Halbkupplung  
Spannbuchse E**

**Demi - accouplement  
moyeu amovible E**

**Semiacoplamiento  
casquillo conico E**



<b>Nostro codice</b> <b>Our code</b> <b>Unser Code</b> <b>Notre code</b> <b>Nuestro código</b>	GTE2838	<b>Bussola</b> <b>Bush</b> <b>Buchse</b> <b>Douille</b> <b>Buje</b>	1108
	GTE3845		1108
	GTE4255		1610
	GTE4860		1615
	GTE5570		2012
GTE7590	2517		

**Elemento elastico nero**  
**Black spider**  
**Schwarzes Zwischenglied**  
**Etoile noire**  
**Elemento elástico negro**  
**94 Shore A**

**Elemento elastico giallo**  
**Yellow spider**  
**Gelbes Zwischenglied**  
**Etoile jaune**  
**Elemento elástico amarillo**  
**92 Shore A**

**Elemento elastico rosso**  
**Red spider**  
**Rotes Zwischenglied**  
**Etoile rouge**  
**Elemento elástico rojo**  
**98 Shore A**



<b>Nostro codice</b> <b>Our code</b> <b>Unser Code</b> <b>Notre code</b> <b>Nuestro código</b>	EN28038
	EN38045
	EN42055
	EN48060
	EN55070
EN75090	

<b>Nostro codice</b> <b>Our code</b> <b>Unser Code</b> <b>Notre code</b> <b>Nuestro código</b>	EG28038
	EG38045
	EG42055
	EG48060
	EG55070
EG75090	

<b>Nostro codice</b> <b>Our code</b> <b>Unser Code</b> <b>Notre code</b> <b>Nuestro código</b>	ER28038
	ER38045
	ER42055
	ER48060
	ER55070
ER75090	

Giunti  SG-HRC

 SG-HRC couplings

 SG-HRC Kupplungen

Accouplements  SG-HRC

Acoplamientos  SG-HRC



I giunti  sono essenzialmente dei giunti per applicazioni generiche, dotati di un elemento flessibile in grado di compensare un elevato grado di disallineamento:

Disallineamento parallelo fino a 0,5 mm

Disallineamento assiale fino a 1,7 mm

Grazie a caratteristiche progettuali di elevata qualità, i giunti  possono alloggiare alberi di dimensioni maggiori, e presentano quindi interessanti vantaggi economici.

 Couplings are essentially general purpose couplings with a flexible element which can accommodate higher degree of misalignment.

Parallel misalignment upto 0.5 mm

Axial misalignment up to 1.7 mm

Because of their superior design  Couplings can accommodate larger shafts which make them a more economical proposition.

 Kupplungen sind grundsätzlich Kupplungen für allgemeine Anwendungen, die mit einem flexiblen Zwischen-glied zum Ausgleich eines hohen Verlagerungsgrad versehen sind.

Parallelverlagerung bis zu 0,5 mm

Axialverlagerung bis zu 1,7 mm

Dank der Auslegung nach neuesten Erkenntnissen, können die  Kupplungen auch Wellen größerer Abmessungen aufnehmen und weisen daher interessante Preisvorteile auf.

Les  accouplements  sont essentiellement des accouplements pour applications générales, pourvus d'un élément flexible capable de compenser un haut niveau de désalignement:

Désalignement parallèle jusqu'à 0,5 mm

Désalignement axial jusqu'à 1,7 mm

Grâce à des caractéristiques projectuelles de haut niveau, les accouplements  peuvent loger des arbres de plus grandes dimensions et présentent donc des intéressants avantages économiques.

Los acoplamientos  son esencialmente acoplamientos de uso general, provistos de un elemento flexible capaz de compensar un elevado nivel de desalineación:

Desalineación paralela hasta 0,5 mm

Desalineación axial hasta 1,7 mm

Gracias a características de elevada calidad específicas del diseño, los acoplamientos  pueden alojar ejes de dimensiones superiores, ofreciendo por lo tanto interesantes ventajas económicas.

## Caratteristiche principali

### Progettazione

Il design dei giunti  è stato ottimizzato in modo che le caratteristiche di potenza siano bilanciate ai diametri specifici degli alberi mediante l'installazione di bussole TL.

### Resilienza

I carichi massimi temporanei vengono ridotti grazie ad un componente flessibile, la cui deformazione è un fattore progettuale di importanza cruciale.

### Disallineamento

È possibile correggere lo spostamento incidentale parallelo, angolare ed assiale degli alberi collegati.

### Installazione

Facile e veloce senza bisogno di utensili speciali, soltanto di un girabrugole.

### Manutenzione

È praticamente inesistente e non è richiesto alcun lubrificante.

### Fattori ambientali

L'elemento elastico rende i giunti  adatti all'impiego nella maggior parte delle condizioni a temperatura da -40 a +100 °C.

### Vantaggi

Nell'improbabile evento di una distruzione del componente flessibile, la trasmissione verrà mantenuta comunque mediante l'interazione delle bride (denti d'arresto) che integrano le flange.

## Salient features

### Economy

The design of the  coupling has been optimised so that power capacities are balanced to the appropriate shaft diameters utilising Taper-Lock® Bush fixing.

### Resilience

Transient peak loads are reduced by a flexible component, deflection of which is a prime design consideration.

### Misalignment

Incidental parallel, angular and axial displacement of the connected shafts can be accommodated.

### Installation

Quick and easy without special tools, only an allen key is required.

### Maintenance

Virtually eliminated and no lubricant is required.

### Environment

The elastomeric component makes  coupling suitable for use in most conditions within a temperature range of -40°C to +100°C.

### Positive

In the unlikely event of the flexible component being destroyed, the drive will be maintained by the interaction of dogs which are integral with the flanges.

## Hauptmerkmale

### Planung

Die Planung der  Kupplungen ist so optimiert worden, daß die unterschiedlichen Leistungsfähigkeiten den spezifischen Wellendurchmessern durch die Montage von Spannbuchsen angemessen sind.

### Belastbarkeit

Die max. vorübergehenden Belastungen werden durch ein elastisches Zwischen-glied, deren Verformung als maßgebendes Planungskriterium gilt, reduziert.

### Verlagerung

Es ist möglich, die gelegentlichen Parallel-, Winkel- und Axialverlagerung der verbundenen Wellen auszugleichen.

### Montage

 Kupplungen können leicht und schnell ohne Sondergeräte montiert werden, nur mit Hilfe eines Inbus-schlüssels.

### Wartung

 Kupplungen sind praktisch, wartungsfrei und bedürfen keiner Schmierung.

### Umgebungsfaktoren

Das elastische Zwischenglied macht die  Kupplungen passend für die Verwendung unter den meisten Verhältnissen bei Temperaturen von -40 bis zu +100 °C.

### Vorteile (Durchschlag-sicherheit)

Auch in dem höchst unwahrscheinlichen Fall einer Zerstörung des Zwischenglieds im Betrieb, wird die Kraftübertragung dank dem Zusammenwirken der Stellklauen mit den Flanschen weiter garantiert werden.

## Caractéristiques principales

### Conception

La conception des accouplements  a été optimisée de telle façon que les caractéristiques de puissance soient proportionnées aux diamètres spécifiques des arbres à travers le montage de moyeux amovibles.

### Resilience

Les charges maximales temporaires sont réduites à l'aide d'un composant flexible dont la déformation est un facteur projectuel d'importance cruciale.

### Desalignement

Il est possible de corriger le déplacement incident parallèle, angulaire et axial des arbres reliés.

### Montage

Facile et rapide sans besoin d'outils spéciaux, mais seulement d'une clé 6 pans.

### Entretien

Il est pratiquement éliminé et aucun lubrifiant n'est nécessaire.

### Facteurs environnementaux

L'élément élastique rend les accouplements  appropriés à l'utilisation dans la plupart des conditions, dans une plage de température de -40° à +100 °C.

### Avantages

Au cas très improbable d'une destruction du composant flexible, la transmission sera gardée quand même moyennant l'interaction des dents d'arrêt qui intègrent les flasques.

## Características principales

### Diseño

El diseño de los acoplamientos  ha sido optimizado de manera que las características de potencia sean equilibradas con respeto a los diámetros específicos de los ejes a través de la instalación de casquillos Cónicos.

### Resiliencia

Las cargas máximas temporáneas se reducen gracias a un componente flexible, cuya deformación es un factor de diseño de fundamental importancia.

### Desalineación

Es posible corregir el desplazamiento accidental paralelo, angular y axial de los ejes conectados.

### Instalación

Fácil y rápida sin necesidad de herramientas especiales, únicamente de un destornillador Allen.

### Mantenimiento

Es prácticamente inexistente y no se necesita ningún lubricante.

### Factores ambientales

El elemento elástico hace que los acoplamientos  resulten adecuados para la mayoría de las condiciones a temperaturas oscilantes entre -40° C a +100° C.

### Ventajas

En la improbable eventualidad de que el componente flexible se destruyera, la transmisión sería igualmente mantenida a través de la interacción entre los trinquetes (ruedas dentadas) que integran las bridas.

Tabella 1 Fattori Di Esercizio	Table 1 Service Factors	Tabelle 1 Betriebsfaktoren	Tableau 1 Facteurs d'exercice	Tabla 1 Factores de Trabajo						
Casi Speciali / Special Cases / Sonderfälle / Cas Speciaux / Casos Especiales		Tipi Di Trasmissione / Types Of Driving Unit / Antriebsart Types De Transmission / Tipos De Transmisión								
<p>Per applicazioni in cui si verificano urti consistenti, vibrazioni e fluttuazioni della coppia e per macchine con moto alterno, come motori a combustione interna, pompe a pistone e compressori, richiedere alla SATI l'analisi torsionale fornendo i dati delle macchine.</p> <p>For applications where substantial shock, vibration and torque fluctuation occur and for reciprocating machines, e.g. internal combustion engines, piston type pumps and compressors, refer to SATI with full machine details for torsional analysis</p> <p>Für Anwendungen mit starken Stößen, Vibrationen und Drehmomentschwingungen, Kolbenmaschinen wie Verbrennungsmotoren, Kolbenpumpen und Kompressoren liefert SATI gegen Vorlegung der Maschinen Daten eine Drehmomentanalyse.</p> <p>Pour les applications dans lesquelles se vérifient des chocs considérables, des vibrations et des fluctuations du couple et pour les machines à piston, comme les moteurs à combustion, pompes et compresseurs à piston, pour avoir l'analyse torsionnelle soumettre à SATI les données des machines.</p> <p>Para usos en los que se produzcan choques consistentes, vibraciones y fluctuaciones del par y para máquinas con movimiento alternativo tal como motores de combustión interna, bombas de pistones compresores, solicítense a SATI el análisis torsional proporcionándole los datos de las máquinas.</p>		<p>Motors a combustione interna Motori a vapore Turbine ad acqua Internal Combustion Engines Steam Engines Water Turbines Verbrennungsmotoren Dampfmotoren Wasserturbinen Moteurs à combustion Moteurs à vapeur Turbines à eau Motores de combustión interna Motores de vapor Turbinas de agua</p>								
<p>Tipi di azionamento delle macchine / Driven machine class Maschinenantriebsart / Type d'entraînement des machines Tipo di arranque de las máquinas</p>		<p>Ore di funzionamento giornaliero / Operational hours per day / Betriebsstunden Täglich Heures de fonctionnement par jour / Horas de funcionamiento diarias</p> <table border="1" data-bbox="804 723 1509 837"> <thead> <tr> <th data-bbox="804 723 903 837">Fino a 8 8 and under Bis 8 Jusqu'à 8 Hasta 8</th> <th data-bbox="903 723 1062 837">Da 8 a 16 Over 8 to 16 inclusive 8 bis 16 8 à 16 De 8 a 16</th> <th data-bbox="1062 723 1161 837">Più di 16 Over 16 Über 16 Plus de 16 Más de 16</th> <th data-bbox="1161 723 1259 837">Fino a 8 8 and under Bis 8 Jusqu'à 8 Hasta 8</th> <th data-bbox="1259 723 1420 837">Da 8 a 16 Over 8 to 16 inclusive 8 bis 16 8 à 16 De 8 a 16</th> <th data-bbox="1420 723 1509 837">Più di 16 Over 16 Über 16 Plus de 16 Más de 16</th> </tr> </thead> </table>			Fino a 8 8 and under Bis 8 Jusqu'à 8 Hasta 8	Da 8 a 16 Over 8 to 16 inclusive 8 bis 16 8 à 16 De 8 a 16	Più di 16 Over 16 Über 16 Plus de 16 Más de 16	Fino a 8 8 and under Bis 8 Jusqu'à 8 Hasta 8	Da 8 a 16 Over 8 to 16 inclusive 8 bis 16 8 à 16 De 8 a 16	Più di 16 Over 16 Über 16 Plus de 16 Más de 16
Fino a 8 8 and under Bis 8 Jusqu'à 8 Hasta 8	Da 8 a 16 Over 8 to 16 inclusive 8 bis 16 8 à 16 De 8 a 16	Più di 16 Over 16 Über 16 Plus de 16 Más de 16	Fino a 8 8 and under Bis 8 Jusqu'à 8 Hasta 8	Da 8 a 16 Over 8 to 16 inclusive 8 bis 16 8 à 16 De 8 a 16	Più di 16 Over 16 Über 16 Plus de 16 Más de 16					
<p><b>Uniforme</b> Agitatori, erogatori di bevande, soffiatori centrifughi e compressori, trasportatori, pompe e ventole centrifughe, generatori, impianti di trattamento dei liquami.</p> <p><b>Uniform</b> Agitators, Brewing Machinery, Centrifugal Blower and Compressors, Conveyors, Centrifugal Fans and Pumps, Generators, Sewage Disposal Equipment.</p> <p><b>Gleichmäßig</b> Rührapparate, Getränkeautomaten, Schleudlüfter und -kompressoren, Förderanlagen, Zentrifugalpumpen und -lüfter, Generatoren, Abwasserentsorgungsanlage.</p> <p><b>Uniforme</b> Agitateurs, distributeurs de boissons, souffleurs et compresseurs centrifuges, transporteurs, pompes et ventilateurs centrifuges, générateurs, unités d'évacuation des eaux usées.</p> <p><b>Uniforme</b> Agitadores, distribuidor de bebidas, sopladores, centrifugas y compresores, transportadores, bombas y ventiladores centrifugos, generadores, plantas de transformación de abonos orgánicos.</p>		1,00	1,12	1,25	1,25	1,40	1,60			
<p><b>Urto moderato*</b> Macchine per la lavorazione dell'argilla, argani a gru, macchine per lavanderie, macchine per lavorazione legno, macchine utensili, mulini rotanti, macchine per cartiere, macchine tessili</p> <p><b>Moderate shock*</b> Clay working machinery, Cranes Hoist, Laundry machinery, Wood working machinery, Machinery Tools, Rotary Mills, Paper Mill machinery, Textile machinery.</p> <p><b>Mäßiger Stoß*</b> Tonauflbereitungsmaschinen, Hebezeuge, Wäschereimaschinen, Holzbearbeitungsmaschinen, Werkzeugmaschinen, Walzmühlen, Papiermühlen, Textilmaschinen</p> <p><b>Choc modéré*</b> Machines pour le traitement de l'argile, machines d'ébénisterie, laveries automatiques, machines outils, moulins rotatifs, machines de papeterie, machines textiles.</p> <p><b>Choque moderado*</b> Maquinarias para procesar la arcilla, cabrestantes de grúa, maquinarias de lavandería, maquinarias para madera, máquinas-herramienta, molinos giratorios, maquinarias para las fábricas de pasta de papel, máquinas textiles</p>		1,60	1,80	2,00	2,00	2,24	2,50			
<p><b>Urto pesante*</b> Trasportatori a moto alterno, frantumatori, scuotitori, mulini metallici, macchine lavorazione gomma, (mescolatori Banbury), compressori a moto alterno.</p> <p><b>Heavy shock*</b> Reciprocating conveyors, Crushers, Shakers, Metal Mills, Rubber machinery, (Banbury Mixers and Mills), Reciprocating compressors.</p> <p><b>Starker Stoß*</b> Kolbenförderer, Brecher, Schüttler, Metallmühlen, Gummimaschinen, (Banbury-Mischer), Kolbenkompressoren.</p> <p><b>Choc lourd*</b> Transporteurs à piston, broyeuses, secoueurs, moulins métalliques, machines pour le traitement du caoutchouc, (mélangeurs et moulins à piston), compresseurs à piston.</p> <p><b>Choque pesante*</b> Transportadores con movimiento alternativo, trituradores, sacudidores, molinos metálicos, maquinarias para la transformación de caucho, (mezcladores Banbury), compresores con movimiento alternativo.</p>		2,50	2,80	3,12	3,12	3,55	4,00			

\* Si raccomanda di fissare le chiavette (con gioco verticale se in bussola TL) laddove ci si aspetta una fluttuazione del carico

\* It is recommended that keys (with top clearance if in Taper Lock Bushes) are fitted for applications where load fluctuation is expected

\* Wir empfehlen, daß die Paßfedern (mit vertikalem Spiel bei Spannbuchsen) in den Anwendungen wo eine Lastschwungung vorzusehen ist befestigt werden.

\* On recommande de fixer les clavettes (avec jeu vertical dans les moyeux amovibles) dans les applications où on prévoit une fluctuation de la charge

\* Se recomienda fijar las chavetas (con juego vertical en casquillos TL) en e caso de que se espere una fluctuación de la carga

### Selezione motori elettrici standard

Leggere la tabella 2 e partendo dal telaio del motore trovare la colonna della velocità nominale desiderata  
Trovare il giunto appropriato per Taper Lock H o F

### Selection standard electric motors

Read across the table 2 from the appropriate motor frame size and find the applicable nominal motor speed column.  
Read the appropriate coupling selection for either Taper-Lock<sup>®</sup> H' or F'

### Auswahl Standard Elektromotoren

In die Tabelle 2 nachschlagen und je nach Motorbaugröße die Spalte der gewünschten Nenngeschwindigkeit finden  
Die Passende Kupplung für die Spannbuchse H oder F finden

### Sélection moteurs électriques standard

Lire le tableau 2 et à partir de la taille du moteur trouver la colonne de la vitesse nominale souhaitée  
Trouver l'accouplement approprié pour moyeu amovible H ou F

### Selección motores eléctricos estándar

Leer la tabla 2 y, empezando por el bastidor del motor, encontrar la columna de la velocidad nominal deseada.  
Encontrar la acoplamiento adecuada para Taper Lock H o F.

**Tabella 2**  
Fattori di esercizio non inferiori a 1,6

**Table 2**  
Service factors not less than 1.6

**Tabelle 2**  
Betriebsfaktoren ab 1,6

**Tableau 2**  
Facteurs de service pas inférieurs à 1,6

**Tabla 2**  
Factores de trabajo no inferiores a 1,6

Grandezza telaio motore Motor Frame Size Motorbaugröße Taille du moteur Tamaño bastidor motor	Diametro albero Shaft Dia. Wellendurchm. Diamètre arbre Diámetro eje en mm	3000 rev/min 3000 Umdr./Min 3000 tours/min 3000 rev/min		1500 rev/min 1500 Umdr./Min 1500 tours/min 1500 rev/min		1000 rev/min 1000 Umdr./Min 1000 tours/min 1000 rev/min		750 rev/min 750 Umdr./Min 750 tours/min 750 rev/min	
		Potenza motore Motor Power Motorleistung Puissance moteur Potencia motor KW	Grandezza giunto Coupling Size Kupplungsgröße Taille de l'accouplement Tamaño acoplamiento	Potenza motore Motor Power Motorleistung Puissance moteur Potencia motor KW	Grandezza giunto Coupling Size Kupplungsgröße Taille de l'accouplement Tamaño acoplamiento	Potenza motore Motor Power Motorleistung Puissance moteur Potencia motor KW	Grandezza giunto Coupling Size Kupplungsgröße Taille de l'accouplement Tamaño acoplamiento	Potenza motore Motor Power Motorleistung Puissance moteur Potencia motor KW	Grandezza giunto Coupling Size Kupplungsgröße Taille de l'accouplement Tamaño acoplamiento
<b>90 S</b>	24	1,5	70	1,1	70	0,75	70	-	-
<b>90 L</b>	24	2,2	70	1,5	70	1,1	70	-	-
<b>112 M</b>	28	4	90	4	90	2,2	90	1,5	90
<b>132 S</b>	38	5,5	110	5,5	110	3	110	2,2	110
		7,5	110						
<b>132 M</b>	38			7,5	110	4	110	3	110
						5,5	110		
<b>160 M</b>	42	11	110	11	110	7,5	110	4	110
		15	110					5,5	110
<b>160 L</b>	42	18,5	110	15	110	11	130	7,5	110
<b>180 M</b>	48	22	150	18,5	150				
<b>180 L</b>	48			22	150	15	150	11	150
<b>200 L</b>	55	30	180			18,5	180	15	180
		37	180	30	180	22	180		
<b>225 S</b>	60			37	180			18,5	180
<b>225 M</b>	55*	45	180	45	180	30	180	22	180
	60								
<b>250 M</b>	60*	55	180	55	230	37	230	30	230
	65								
<b>280 S</b>	75			75	230	45	230	37	230
<b>280 M</b>	75			90	230	55	230	37	230

\*3000 rev/min only.

\* 3000 rev/mm only.

\* Nur 3000 UPM.

\* Seulement 3000 TPM.

\*3000 rev/min sólo.



**a) Fattore di esercizio**

Determinare il fattore di esercizio richiesto da Tabella 1

**b) Potenza calcolata**

Moltiplicare la normale potenza di funzionamento per il fattore di esercizio per ottenere la potenza calcolata che viene usata come base per la scelta del giunto.

**c) Grandezza del giunto**

Fare riferimento alla tabella 3 e partendo dalla velocità appropriata nella colonna relativa, cercare una potenza uguale o maggiore alla potenza calcolata richiesta.

**d) Dimensioni del foro**

Verificare dalla tabella dimensionale 5 che i mozzetti prescelti possano accogliere i fori richiesti.

Esempio: Si richiede un giunto per l'albero per trasmettere 70 kW da un motore elettrico da 1440 rpm ad un argano che lavora 16 ore al giorno. L'albero del motore è 70 mm e l'albero dell'argano è 75 mm

a. Fattore di esercizio  
Dalla tabella 1, il fattore di esercizio è 2.

b. Potenza calcolata:  
 $70 \times 2 = 140 \text{ kW}$

**c) Grandezza del giunto**  
Leggendo la Tabella 3 (Potenze nominali), in corrispondenza della velocità di 1440 rpm si trova la potenza di 143 kW, la prima superiore ai 140 kW della potenza calcolata. La grandezza del giunto in cima a questa colonna è 180.

**d) Grandezza del foro**  
Con riferimento alla Tabella dimensionale 5 si può vedere che per il giunto HRC del tipo 180B entrambi i diametri dell'albero rientrano nel range dei fori disponibili. Tuttavia, nel caso in cui sia necessario scegliere un giunto di tipo per bussola conica, scegliere HRC-230.

**a) Service Factor**

Determine the required service factor from Table 1.

**b) Design Power**

Multiply the normal running power by the service factor. This gives the Design Power which is used as a basis for coupling selection.

**c) Coupling Size**

Refer to Table 3 and from the appropriate speed in the speed column, read across until a power equal to or greater than the design power required is found.

**d) Bore Size**

From the dimension Table 5 check that the chosen hubs can accommodate the required bores. Registered Trade Mark

Example: A shaft coupling is required to transmit 70kW between a 1440 rev/mm electric motor and a hoist running over 16 hours/day. The motor shaft is 70 mm. and the hoist shaft is 75 mm.

a. Service Factor  
From Table 1, the Service Factor is 2.

b. Design Power  
Design Power:  
 $70 \times 2 = 140 \text{ kW}$

**c) Coupling Size**  
By reading across from 1440 rev/mm in the speed column of Table 3 (Power Rating Table) 143 kW is the first power to exceed the required 140 kW (design power). The size of coupling at the head of this column is 180.

**d) Bore Size**  
By referring to the Dimension table 5 it can be seen that for HRC - 180B type both shaft diameters fall within the bore range available. However in case the coupling selection is required in taper bore then select HRC-230.

**a) Betriebsfaktor**

Den erforderlichen Betriebsfaktor aus Tabelle 1 bestimmen.

**b) Berechnungsleistung**

Um die Berechnungsleistung, die als Grund zur Auswahl der Kupplung benutzt wird, zu erhalten, die normale Betriebsleistung mit dem Betriebsfaktor multiplizieren.

**c) Kupplungsgröße**

Auf Tabelle 3 Bezug nehmen und je nach gewünschter Geschwindigkeit in der entsprechenden Spalte, eine Leistung suchen, die gleich oder größer als die Berechnungsleistung ist.

**d) Bohrungsgröße**

In der Abmessungstabelle 2 prüfen, ob die gewählten Nabe die erforderlichen Bohrungen aufnehmen können.

Beispiel: Eine Wellenkupplung wird zur Übertragung von 70 kW gebraucht, von einem 1440 Upm Elektromotor zu einem Hebezeug, der 16 Stunden am Tag funktioniert. Die Motorwelle ist 70 mm und die Hebezeugwelle 75 mm

a. Betriebsfaktor  
Aus Tabelle 1, der Betriebsfaktor ist 2.

b. Berechnungsleistung:  
 $70 \times 2 = 140 \text{ kW}$

**c) Kupplungsgröße**  
In Tabelle 3 (Nennleistungen), entspricht einer Geschwindigkeit von 1440 Upm eine Leistung von 143 kW, die erste Leistung höher als die 140 kW der Berechnungsleistung. Die Kupplungsgröße oben auf dieser Spalte ist 180.

**d) Bohrungsgröße**  
In Bezug auf Abmessungstabelle 5 kann man sehen, daß für die HRC Kupplung Typ 180B beide Wellendurchmesser in dem Bereich der verfügbaren Bohrungen enthalten sind. Allerdings, falls eine Kupplung der Reihe erforderlich ist, wählen Sie HRC-230 der für spamblichse.

**a) Facteur de service**

Déterminer le facteur de service requis suivant le Tableau 1

**b) Puissance calculée**

Multiplier la puissance normale de fonctionnement par le facteur de service afin d'obtenir la puissance calculée qui est utilisée comme point de départ pour le choix de l'acoplamiento.

**c) Taille de l'accouplement**

Se référer au tableau 3 et, à partir de la vitesse appropriée dans la colonne relative, chercher une puissance égale ou supérieure à la puissance calculée requise.

**d) Taille de l'alésage**

Vérifier dans le tableau dimensionnel 5 que les moyeux choisis puissent accueillir les alésages nécessaires.

Exemple: On a besoin d'un accouplement pour transmettre 70 kW d'un moteur électrique de 1440 tpm à un treuil qui travaille 16 heures par jour. L'arbre du moteur est 70 mm et celui du treuil 75 mm

a. Facteur de service  
Dans le tableau 1, le facteur de service est 2.

b. Puissance calculée:  
 $70 \times 2 = 140 \text{ kW}$

**c) Taille de l'accouplement**  
Lisant le tableau 3 (Puissances nominales), sur la même ligne de la vitesse de 1440 tpm on trouve la puissance de 143 kW, la première puissance supérieure aux 140 kW de la puissance calculée. La taille de l'accouplement en haut de cette colonne est 180.

**d) Taille de l'alésage**  
Se référant au Tableau dimensionnel 5 l'on voit que pour l'accouplement HRC du type 180B tous les deux diamètres de l'arbre rentrent dans la plage des alésages disponibles. Toutefois, au cas où il serait nécessaire de choisir un accouplement du type, choisir HRC-230 moyeux amovibles.

**a) Factor de trabajo**

Determina el factor de trabajo requerido por la tabla 1.

**b) Potencia calculada**

Multiplicar la potencia normal de funcionamiento por el factor de trabajo a fin de obtener la potencia calculada que se utiliza como base para elegir el acoplamiento más adecuado.

**c) Tamaño del acoplamiento**

Hacer referencia a la tabla 3 y empezando por la velocidad apropiada en la columna relativa, buscar una potencia igual o superior a la potencia calculada requerida.

**d) Dimensiones del agujero**

Controlar en la tabla dimensional 5 que las cubo seleccionadas puedan acoger los agujeros requeridos.

Ejemplo: se requiere un acoplamiento para el eje a fin de transmitir 70 kW de un motor eléctrico de 1.440 r.p.m. a un cabrestante que funciona durante 16 horas por día. El eje del motor es de 70 mm y el eje del cabrestante es de 75 mm.

a. Factor de trabajo.  
De la tabla 1 resulta que el factor de trabajo es 2.

b. Potencia calculada:  
 $70 \times 2 = 140 \text{ kW}$

**c) Tamaño del acoplamiento**  
Leyendo la tabla 3 (potencias nominales) en correspondencia de la velocidad de 1.440 r.p.m. se halla la potencia de 143 kW, la primera superior a los 140 kW de la potencia calculada. El tamaño del acoplamiento por encima de esta columna es 180.

**d) Tamaño del agujero.**  
En la tabla dimensional 5 es posible ver que para el acoplamiento HRC del tipo 180B ambos diámetros del eje se encuentran dentro del rango de los agujeros disponibles. Sin embargo, en el caso de que sea necesario elegir entre un acoplamiento de tipo, es preciso elegir la HRC-230 para casquillo conico.

**Tabella 3**      **Table 3**      **Tabelle 3**      **Tableau 3 - Puissances**      **Tabla 3 - Potencia**  
**Potenza nominale (kW)**    **Power ratings (kW)**    **Nennleistungen (KW)**    **nominales (kW)**    **nominales (kW)**

Velocità rev/min Speed rev/min Geschwindigkeit Umdr./Min. Vitesse Tours/Min. Velocidad rev/min	Grandezza giunto / Coupling size / Kupplungsgröße / Taille de l'accouplement / Tamaño acoplamiento							
	70,00	90,00	110,00	130,00	150,00	180,00	230,00	280,00
100	0,33	0,84	1,68	3,30	6,28	9,95	20,90	33,00
200	0,66	1,68	3,35	6,60	12,60	19,90	41,90	66,00
400	1,32	3,35	6,70	13,20	25,10	39,80	83,80	132,00
600	1,98	5,03	10,10	19,80	37,70	59,70	126,00	198,00
720	2,37	6,03	12,10	23,80	45,20	71,60	151,00	238,00
800	2,64	6,70	13,40	26,40	50,30	79,60	168,00	264,00
960	3,17	8,40	16,10	31,70	60,30	95,50	210,00	317,00
1200	3,96	10,10	20,10	39,60	75,40	119,00	251,00	396,00
1440	4,75	12,10	24,10	47,50	90,50	143,00	302,00	475,00
1600	5,28	13,40	26,80	52,80	101,00	159,00	335,00	528,00
1800	5,94	15,10	30,20	59,40	113,00	179,00	377,00	594,00
2000	6,60	16,80	33,50	66,00	126,00	199,00	419,00	660,00
2200	7,26	18,40	36,90	72,60	138,00	219,00	461,00	726,00
2400	7,92	20,10	40,20	79,20	151,00	239,00	503,00	
2600	8,58	21,80	43,60	85,80	163,00	259,00	545,00	
2880	9,50	24,10	48,30	95,00	181,00	286,00		
3000	9,90	25,10	50,30	99,00	188,00	298,00		
3600	11,90	30,10	60,30	118,00	226,00			
Coppia Nominale (Nm) / Nominal Torque (Nm) Nennmoment (Nm) / Couple nominal (Nm) Par de giro nominal (Nm)	31,50	80	160	315	600	950	2000	3150
Coppia Massima (Nm) / Max Torque (Nm) Max. Drehmoment (Nm) / Couple max (Nm) Par de giro máximo (Nm)	72	180	360	720	1500	2350	5000	7200

**Tabella 4**      **Table 4**      **Tabelle 4**      **Tableau 4**      **Tabla 4**  
**Caratteristiche fisiche**    **Physical characteristics**    **Physische Merkmale**    **Caracteristiques Physiques**    **Características físicas**

Caratteristiche / Characteristic / Merkmale Caractéristiques / Característicos	Grandezza giunto / Coupling size / Kupplungsgröße / Taille de l'accouplement / Tamaño acoplamiento							
	70	90	110	130	150	180	230	280
Velocità Max* RPM / Maximum Speed* rev/min Höchstgeschwindigkeit* UPM / Vitesse Max.* TPM Velocidad max* rev/min	8300	6740	5110	4400	3800	3180	2540	2080
Coppia Nominale (Nm) / Nominal Torque (Nm) Nennmoment / Couple nominale Par de giro nominal (Nm)	31,5	80	160	315	600	950	2000	3150
Coppia Massima (Nm) / Maximum Torque (Nm) Max. Drehmoment / Couple max. Par de giro máximo (Nm)	72	180	360	720	1500	2350	5000	7200
Disallineamento parallelo Max (mm) / Maximum Parallel Misalignment (mm) / Max. Parallelverlagerung (mm) Désalignement parallèle max. (mm) / Desalineación máxima paralela (mm)	0,3	0,3	0,3	0,4	0,4	0,4	0,5	0,5
Disallineamento assiale Max (mm) Maximum axial Misalignment (mm) / Max. Axialverlagerung (mm) Désalignement axial max (mm) / Desalineación máxima axial (mm)	0,2	0,5	0,6	0,8	0,9	1,1	1,3	1,7

\* Le velocità massime del giunto sono calcolate utilizzando la velocità periferica ammissibile per il materiale del mozzo. Per la selezione delle misure più piccole al di sopra dei 3600 rpm rivolgetevi alla SATI.

\* Maximum coupling speeds are calculated using an allowable peripheral speed for the hub material. For selection of small sizes above 3600 rev/mm - consult SATI.

\* Max. Kupplungsgeschwindigkeiten werden aufgrund der zulässigen Umlaufgeschwindigkeit für den Nabenwerkstoff kalkuliert. Zur Auswahl von kleineren Größen über 3600 Upm wenden Sie sich an SATI.

\* Les vitesses maximales de l'accouplement sont calculées en utilisant la vitesse périphérique admissible pour le matériau du moyeu. Pour la sélection des tailles plus petites en dessus de 3600 Tpm veuillez bien vous adresser à SATI.

\* Las velocidades máximas del acoplamiento se calculan utilizando la velocidad periferica permitida para el material del cubo. Para elegir los tamaños más pequeños con más de 3600 rpm, consúltese con SATI.

Giunti elastici **SG-HRC-T** serie con foro per bussola conica

Elastomeric shaft coupling **SG-HRC-T** taper bore

**SG-HRC-T** Elastische Kupplungen für Spannbuchse

Accouplements élastiques **SG-HRC-T** pour moyeux amovibles

Acoplamiento elástico serie **SG-HRC-T** con agujero para casquillo conico

**Tabella 5**  
**Dimensioni**

**Table 5**  
**Dimensions**

**Tabelle 5**  
**Abmessungen**

**Tableau 5**  
**Dimensions**

**Tabla 5**  
**Dimensiones**

Tipo Type Typ Type Tipo	Potenza Power Leistung Puissance Potencia 100 rpm (kW)	Bussola Bush Buchse Douille Buje	Foro minimo Min bore Min bohrung Alésage Min Agujero Min	Foro massimo Max. bore Max. bohrung Alésage max. Agujero máximo	H <sub>2</sub>	B	E	H	J*	Disallineamento Massimo Maximum misalignment Max. Verlagerung Désalignement max. Desalineación máxima		Massima rivoluzione n(rpm) Maximum revolution n(rpm) Max. Umdrehung n (Upm) Révolution max. (Tpm) Revolución máxima n (r.p.m.)	Momento d'inertzia Moment of inertia Trägheitsmo- ment Moment d'inertie Momento de inercia  (kg/cm <sup>3</sup> )	De	D	b	G
										Parallelo Parallel Parallel Parallèle Paralela	Assiale Axial Axial Axial Axial						
70	0,33	1008	9	25	20	23,5	25	65	29	0,3	+0,2	9100	8,5	69	60	31	18
90	8,84	1108	9	28	19,5	23,5	30,5	69,5	29	0,3	+0,5	7400	11,5	85	70	32	22,5
110	1,68	1610	14	42	18,5	26,5	45	82	38	0,3	+0,6	5630	40	112	100	45	29
130	3,30	1610	14	42	18	26,5	53	89	38	0,4	+0,8	4850	78	130	105	50	36
150	6,28	2012	14	50	23,5	33,5	60	107	42	0,4	+0,9	4200	181	150	115	62	40
180	9,95	2517	16	60	34,5	46,5	73	142	48	0,4	+1,1	3500	434	180	125	77	49
230	20,90	3020	25	75	39,5	52,5	85,5	165	55	0,5	+1,3	2800	1207	225	155	99	59,5
280	33	3525	35	100	51	66,5	106	208	67	0,5	+1,7	2300	4465	275	206	119	74,5

J = Spazio chiave richiesto per il serraggio e l'allentamento della bussola sull'albero.

J = The wrench clearance required for tightening and loosening the bush on the shaft.

J = Raum für den Schlüssel zur Befestigung und Lockerung der Spannbuchse auf der Welle.

J = Espace requis pour la clé de serrage et desserrage du moyeu sur l'arbre.

J = Ranura para chaveta necesaria para apretar y aflojar el casquillo sobre el eje.

Giunti elastici **SG-HRC-M** serie con foro cilindrico

Elastomeric shaft coupling **SG-HRC-M** standard straight bore series

**SG-HRC-M** Elastische Kupplungen mit gerader Bohrung

Accouplements élastiques **SG-HRC-M** avec alésages cylindriques

Acoplamiento elástico serie **SG-HRC-M** con agujero cilíndrico

Tipo Type Typ Type Tipo	Potenza Power Leistung Puissance Potencia 100 rpm (kW)	Foro minimo Min bore Min bohrung Alésage Min Agujero Min	Foro massimo Max. bore Max. bohrung Alésage max. Agujero máximo	H <sub>2</sub>	B	E	H	De	D	b	G
70	0,33	10	32	20	23,5	25,0	65,0	69	60	31	18,0
90	8,84	10	42	26	30,0	30,5	82,5	85	70	32	22,5
110	1,68	10	55	37	45,0	45,0	119,0	112	100	45	29,0
130	3,30	14	60	47	55,5	53,0	147,0	130	105	50	36,0
150	6,28	19	70	50	60,0	60,0	160,0	150	115	62	40,0
180	9,95	35	80	58	70,0	73,0	189,0	180	125	77	49,0
230	20,90	38	100	77	90,0	85,5	239,5	225	155	99	59,5
280	33,00	48	130	90	105,5	105,5	285,5	275	206	119	74,5

**Giunti elastici SG-HRC-M serie con foro cilindrico**  
**Elastomeric shaft coupling SG-HRC-M standard straight bore series**  
**SG-HRC-M elastische Kupplungen mit gerader Bohrung**  
**Accouplements élastiques SG-HRC-M avec alésages cylindriques**  
**Acoplamiento elástico serie SG-HRC-M con agujero cilíndrico**

Materiale Giunto: Ghisa EN-GJL-250 UNI EN 1561	Coupling Material: Cast Iron EN-GJL-250 UNI EN 1561	Kupplungswerkstoff: Grauguß EN-GJL-250 UNI EN 1561	Matériau de l'accouplement: fonte EN-GJL-250 UNI EN 1561	Material acoplamiento: fundición EN-GJ-250 UNI EN 1561
Materiale Elemento Elastico: Gomma	Spider Material: Rubber	Werkstoff des elastischen Zwischenglieds: Gummi	Matériau de l'élément élastique: caoutchouc	Material elemento elástico: goma

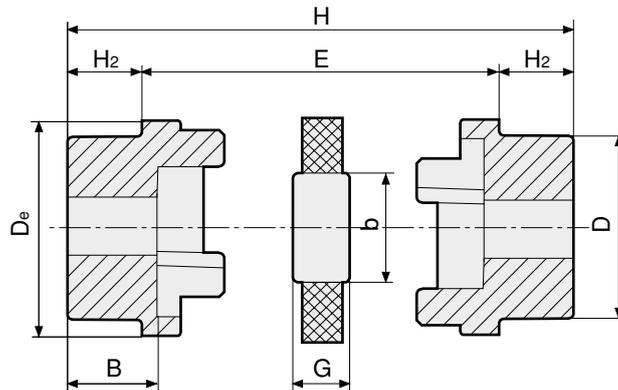

Tipo Type Typ Type Tipo	130 Foro massimo Mozzi / Hubs Max. bore / Max. Nabenbohrung / Alésage max. de moyeux / Agujero máximo cubos		Dimensioni / Dimensions / Abmessungen / Dimensions / Dimensiones [mm]								Kg
	MM	INS	De	D	b	E	G	H2	B	H	
70	32	1 1/4	69	60	31	25,0	18,0	20,0	23,5	65,0	1,20
90	42	1 5/8	85	70	32	30,5	22,5	26,0	30,0	82,5	2,15
110	55	2 1/8	112	100	45	45,0	29,0	37,0	45,0	119,0	6,10
130	60	2 3/8	130	105	50	53,0	36,0	47,0	55,5	147,0	8,90
150	70	2 3/4	150	115	62	60,0	40,0	50,0	60,0	160,0	12,20
180	80	3 1/8	180	125	77	73,0	49,0	58,0	70,0	189,0	18,40
230	100	4"	225	155	99	85,5	59,5	77,0	90,0	239,5	35,50
280	130	5"	275	206	119	105,5	74,5	90,0	105,5	285,5	71,50

**Semigiunto con preforo / Half coupling with pilot bore / Halb-Kupplung mit Vorböhrung**  
**Demi-accouplement avec préalésage / Semiacoplamiento con taladro previo**



			Kg
<b>Nostro codice</b> <b>Our code</b> <b>Unser Code</b> <b>Notre code</b> <b>Nuestro código</b>	HRCP070	HRC70	0,60
	HRCP090	HRC90	1,07
	HRCP110	HRC110	3,05
	HRCP130	HRC130	4,45
	HRCP150	HRC150	6,10
	HRCP180	HRC180	9,20
	HRCP230	HRC230	17,75
	HRCP280	HRC280	35,75

**Elemento elastico nero / Black spider / Schwarzes Zwischenglied**  
**Etoile noire / Elemento elástico negro**



			Kg
<b>Nostro codice</b> <b>Our code</b> <b>Unser Code</b> <b>Notre code</b> <b>Nuestro código</b>	HRCN070	HRC70	0,016
	HRCN090	HRC90	0,05
	HRCN110	HRC110	0,08
	HRCN130	HRC130	0,15
	HRCN150	HRC150	0,22
	HRCN180	HRC180	0,38
	HRCN230	HRC230	0,80
	HRCN280	HRC280	1,53

# Giunti elastici **SG-HRC-T** serie con foro per bussola conica

## Elastomeric shaft coupling **SG-HRC-T** taper bore

## **SG-HRC-T** Elastische Kupplungen für Spannbuchse

## Accouplements élastiques **SG-HRC-T** pour moyeux amovibles

## Acoplamiento elástico serie **SG-HRC-T** con agujero para casquillo conico



Materiale Giunto: Ghisa EN-GJL-250 UNI EN 1561

Materiale Elemento Elastico: Gomma

Coupling Material: Cast Iron EN-GJL-250 UNI EN 1561

Spider Material: Rubber

Kupplungswerkstoff: Grauguß EN-GJL-250 UNI EN 1561

Werkstoff des elastischen Zwischenglieds: Gummi

Matériau de l'accouplement: fonte EN-GJL-250 UNI EN 1561

Matériau de l'élément élastique: caoutchouc

Material acoplamiento: fundición EN-GJ-250 UNI EN 1561

Material elemento elástico: goma

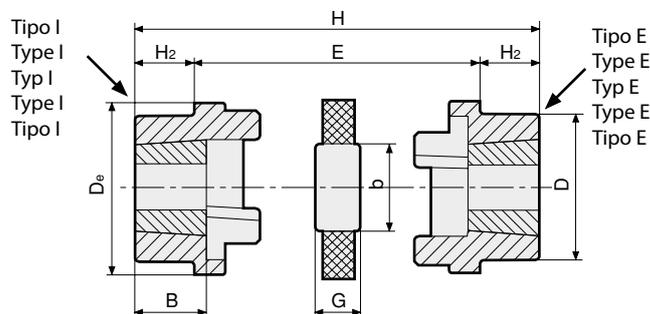

Tipo Type Typ Type Tipo	Bussola Bush Buchse Moyeu Casquillo	Foro massimo Mozzi Hubs Max. bore Max. Naben- bohrung Alésage max. de moyeux Agujero máxi- mo cubos		Dimensioni Dimensions Abmessungen Dimensions Dimensiones [mm]									Disallineamento massimo Maximum misalignment Max. Verlagerung Désalignement max. Desalineación máxima		Massima rivoluzione n(rpm) Maximum revolution n(rpm) Max. Umdrehung n (Upm) Révolution max. (Tpm) Revolución máxima n (r.p.m.)	Momento d'inerzia Moment of inertia Trägheitsmo- ment Moment d'inertie Momento de inerzia (kg/cm <sup>2</sup> )	Kg
		MM	INS	De	D	b	E	G	H <sub>2</sub>	B	J	H	Parallelo Parallel Parallèle Paralela	Assiale Axial Axial Axial			
70	1008	25	1	69	60	31	25,0	18,0	20,0	23,5	29	65,0	0,3	+0,2	9100	8,5	0,88
90	1108	20	1 1/8	85	70	32	30,5	22,5	19,5	23,5	29	69,5	0,3	+0,5	7400	11,5	1,45
110	1610	42	1 5/8	112	100	45	45,0	29,0	18,5	26,5	38	82,0	0,3	+0,6	5630	40,0	3,20
130	1610	42	1 5/8	130	105	50	53,0	36,0	18,0	26,5	38	89,0	0,4	+0,8	4850	78,0	4,54
150	2012	50	2	150	115	62	60,0	40,0	23,5	33,5	42	107,0	0,4	+0,9	4200	181,0	6,60
180	2517	60	2 1/2	180	125	77	73,0	49,0	34,5	46,5	48	142,0	0,4	+1,1	3500	434,0	10,75
230	3020	75	3	225	155	99	85,5	59,5	39,5	52,5	55	165,0	0,5	+1,3	2800	1207,0	19,14
280	3525	100	4	275	206	119	106,0	74,5	51,0	66,5	67	208,0	0,5	+1,7	2300	4465,0	41,00

J = Spazio chiave  
richiesto per il serraggio e  
l'allentamento della bussola  
sull'albero.

J = The wrench clearance  
required for tightening and  
loosening the bush on the shaft.

J = Raum für den Schlüssel zur  
Befestigung und Lockerung  
der Spannbuchse auf der Welle.

J = Espace requis pour la clé  
de serrage et desserrage du  
moyeu sur l'arbre.

J = Ranura para chaveta  
necesaria para apretar y  
aflojar el casquillo sobre el eje.



**Semigiunto bussola interna**  
**Half-coupling with small taper end**  
**Halb-Kupplung mit Innenbuchse**  
**Demi-accouplement avec douille**  
**intérieure**  
**Semiacoplamiento con buje interior**

Nostro codice Our code User Code Notre code Nuestro código	HRCI070	HRC70	1008	0,44
	HRCI090	HRC90	1108	0,72
	HRCI110	HRC110	1610	1,60
	HRCI130	HRC130	1610	2,27
	HRCI150	HRC150	2012	3,30
	HRCI180	HRC180	2517	5,37
	HRCI230	HRC230	3020	9,57
	HRCI280	HRC280	3525	20,50



**Semigiunto bussola esterna**  
**Half-coupling with large taper end**  
**Halb-Kupplung mit Außenbuchse**  
**Demi-accouplement avec douille**  
**extérieure**  
**Semiacoplamiento con buje exterior**

Nostro codice Our code User Code Notre code Nuestro código	HRCE070	HRC70	1008	0,44
	HRCE090	HRC90	1108	0,72
	HRCE110	HRC110	1610	1,60
	HRCE130	HRC130	1610	2,27
	HRCE150	HRC150	2012	3,30
	HRCE180	HRC180	2517	5,37
	HRCE230	HRC230	3020	9,53
	HRCE280	HRC280	3525	20,50



**Elemento elastico nero**  
**Black spider**  
**Schwarzes Zwischenglied**  
**Etoile noire**  
**Elemento elástico negro**

Nostro codice Our code User Code Notre code Nuestro código	HRCN070	HRC70	0,016	Kg
	HRCN090	HRC90	0,05	
	HRCN110	HRC110	0,08	
	HRCN130	HRC130	0,15	
	HRCN150	HRC150	0,22	
	HRCN180	HRC180	0,38	
	HRCN230	HRC230	0,80	
	HRCN280	HRC280	1,53	



**Condizioni generali di vendita**  
**General sale's terms**  
**Allgemeine Verkaufsbedingungen**  
**Conditions générales de vente**



## Condizioni generali di vendita

- 1) **ORDINI.** Per la vendita dei propri articoli Sati S.p.A. accetta unicamente ordini scritti. Invitiamo a consultare il catalogo indicando i nostri codici prodotto e ad inviare gli ordini a mezzo fax o e-mail. Una volta iniziata la lavorazione o l'imballo dei pezzi non vengono accettati annullamenti o riduzioni dell'ordine - salvo differenti accordi con il nostro personale interno. Per i prodotti realizzati su specifica del cliente, il numero di pezzi spediti può variare del  $\pm 5\%$  rispetto alla quantità ordinata; la fatturazione al committente viene adeguata di conseguenza.
- 2) **PREZZI.** I prezzi vengono concordati in fase di offerta o fanno riferimento al listino generale. Sati S.p.A. si riserva la facoltà di modificare le proprie quotazioni, ove ciò si rendesse necessario come conseguenza di mutate condizioni di mercato e di produzione.
- 3) **DIVIETO DI CESSIONE.** Gli obblighi e i diritti del Cliente non possono essere ceduti a terzi senza la previa autorizzazione di Sati S.p.A.
- 4) **TERMINI E MODALITÀ DI PAGAMENTO.** I termini e le modalità di pagamento devono essere preventivamente concordati con il nostro ufficio vendite. Non sono consentiti arrotondamenti o trattenute sugli importi dovuti se non autorizzati dall'ufficio vendite. L'insolvenza di R.L.BA e ogni ritardato pagamento genera l'addebito di spese e di interessi di mora fino al massimo previsto dalla legge. Le commissioni della banca estera relative ai pagamenti sono a carico dell'ordinante.
- 5) **RISERVA DI PROPRIETÀ.** La merce viene venduta con riserva di proprietà, fino al pagamento dell'intero prezzo, compresi eventuali interessi e accessori. Il rilascio di cambiali ed eventuali loro rinnovi, anche parziali, da parte del Cliente, non può considerarsi estinzione, né quale novazione né quale pagamento definitivo del prezzo, se non a buon fine delle cambiali stesse; analogamente, il rilascio di cambiali non può pregiudicare la riserva di proprietà. Nonostante quanto precede, il rischio di perdita, perimento o danneggiamento viene trasferito al Cliente in sede di consegna in conformità con quanto previsto negli art. 6 e 8 delle presenti condizioni.
- 6) **TERMINI DI CONSEGNA.** I termini di consegna delle forniture devono essere concordati ad ogni ordine. In caso di difficoltà nell'approvvigionamento dei materiali o comunque in tutti i casi di forza maggiore, i termini di consegna possono subire variazioni senza pregiudicare la validità dell'ordine. Nel caso di prodotti realizzati su specifica, il Cliente è in ogni caso tenuto al ritiro del materiale ordinato. È in ogni caso esclusa la responsabilità della Sati S.p.A. per danni da mancata o ridotta produzione, nonché per danni indiretti e consequenziali, derivanti nel ritardo nella consegna dei prodotti ordinati.
- 7) **IMBALLO.** Sati S.p.A. fattura l'imballo dei propri prodotti al prezzo di costo.
- 8) **TRASPORTO.** Le condizioni di trasporto devono essere concordate tra Sati S.p.A. e il Cliente. La merce viaggia a rischio e pericolo del committente, salvo le responsabilità del vettore ai sensi dell'Art. 1693 cc.
- 9) **RECLAMI.** Eventuali reclami e contestazioni sulla merce consegnata devono essere segnalati per iscritto entro 20 giorni lavorativi dal ricevimento della merce. Il trattamento da adottare per i singoli pezzi riconosciuti difettosi - compresi gli eventuali oneri economici -, e la decisione sull'intera fornitura, devono essere sempre concordate. In particolare, non si accetta l'addebito di costi di riparazione sostenuti direttamente dal Cliente, se non preventivamente autorizzati dal nostro personale interno. La presenza di materiale contestato all'interno di una fornitura non giustifica in alcun modo un ritardato o mancato pagamento dell'intera fattura relativa alla fornitura stessa.
- 10) **GARANZIA.** La Ditta Sati S.p.A. si impegna a riparare o sostituire gratuitamente quei pezzi da essa riconosciuti difettosi. La merce contestata deve essere resa alla sede della Sati S.p.A., franco di ogni spesa. La garanzia decade qualora i pezzi resi come difettosi siano stati riparati o manomessi. Le riparazioni di pezzi difettosi eseguite dal committente saranno riconosciute solamente dietro autorizzazione della Sati S.p.A. e dopo approvazione di essa del preventivo di spesa. La Sati S.p.A. non assume responsabilità né riconosce indennizzi di sorta per danni che si verificassero durante l'impiego dei suoi prodotti anche se difettosi.
- 11) **RESPONSABILITÀ.** La Ditta Sati S.p.A. non assume responsabilità né riconosce indennizzi di sorta per danni che si verificassero durante l'impiego dei suoi prodotti anche se difettosi. La Sati S.p.A. declina ogni responsabilità nell'esecuzione di particolari su disegno del cliente sottostanti ed eventuali brevetti.
- 12) **RESI.** Le condizioni per il reso della merce, che non deve essere in alcun modo lavorata o trattata dal cliente, devono essere preventivamente concordate con il nostro personale; in caso contrario gli eventuali resi saranno rispediti al mittente con spese di trasporto a Suo carico. La merce resa deve viaggiare con imballi idonei al trasporto onde evitare danneggiamenti ai pezzi. Non verranno accettati colli manomessi o non integri. Nelle bolle di sostituzione dovranno essere indicati gli estremi del nostro documento di trasporto e della fattura inerente la fornitura. Per i resi di nostro materiale dovuti a cause diverse da: difetti qualitativi, difformità rispetto a quanto ordinato, nostro errore di spedizione, Sati S.p.A. si riserva di addebitare un 15% del valore della merce resa a copertura dei costi di movimentazione e stoccaggio delle merci e la restituzione deve essere effettuata in porto franco.
- 13) **LEGGE APPLICABILE.** Qualsiasi rapporto derivante, disciplinato o comunque collegato alle presenti condizioni generali sarà sottoposto esclusivamente alla legge italiana.
- 14) **FORO COMPETENTE.** Per qualsiasi controversia in materia di esecuzione, interpretazione o risoluzione di un qualsiasi rapporto derivante, disciplinato o comunque collegato alle presenti condizioni generali, sarà competente in via esclusiva il foro di Bologna, salva la facoltà di Sati S.p.A. di convenire il Cliente presso il foro territorialmente competente per il luogo in cui il medesimo Cliente ha la propria sede.

## General sales terms

- 1) **ORDERS.** Sati S.p.A. accepts only written orders. Customers shall place orders by fax or by e-mail and if possible they shall indicate the product codes which are to be found in the general catalogue. Once an order has been processed or packaged, it can no longer be cancelled or reduced - except in case of specific agreement with our Sales Office. The quantity of items produced according to customer's drawings can vary of  $\pm 5\%$  with respect to the ordered quantity; invoices adjust accordingly.
- 2) **PRICES.** Prices are agreed at the time of quotation or refer to the general price list. Sati S.p.A. reserves the faculty to modify its prices, if changes in market and production conditions make it necessary.
- 3) **PROHIBITION OF ASSIGNMENT.** Contractual rights and liabilities can not be assigned to third parties without prior authorization from Sati S.p.A.
- 4) **PAYMENT TERMS.** Payment terms shall be agreed in advance with our Sales Office. Unless authorized by our Sales Department, rounding-offs or deductions from the amounts due are not allowed. Unpaid cash orders and delayed payments determine expenses and delay interests charged to the Customer in the limits foreseen by the Italian law. Foreign bank charges related to payments are at Customer's expenses.
- 5) **RETENTION OF TITLE.** Goods are subject to retention of title, until they are fully paid for, including interests and accessories. Customer's drawing or renewing (full or in part) of bills of exchange shall not be considered as extinction, novation or final payment of the price, until the full payment occurs. Similarly, drawing bills of exchange do not compromise the retention of title. Notwithstanding the foregoing, risks of loss, failure or damage shall transfer to the Customer upon goods delivery, as stated in articles 6 and 8 of these sales terms.
- 6) **DELIVERY TERMS.** Upon placement of each order, delivery terms must be arranged and reconfirmed by Sati S.p.A. Delivery terms may vary in case of production problems, difficulties in collecting material or in the event of force majeure, without affecting the validity of the order. The Customer is forced to collect items according to drawing in any case. Sati S.p.A. shall not incur any liability by reason of damages due to failed or reduced production of goods, nor for indirect and consequential damages caused by delays in the delivery of ordered goods.
- 7) **PACKAGING.** Sati S.p.A. charges packaging at cost price.
- 8) **TRANSPORTATION.** Transport conditions must be agreed between Sati S.p.A. and the Customer. Goods travel at the risk of the Customer, except from the carrier's liability by virtue of article 1693 of the Italian Civil Code.
- 9) **CLAIMS.** Potential claims and objections on delivered goods must be reported in writing within 20 days from receipt of the goods. Decisions concerning admittedly defective goods and the entire supply these goods belong to - including economic charges - always have to be agreed upon with our Sales Office. In particular, Customer repair costs charges, unless previously authorised by our employees, are not accepted. A supply containing contested products does not justify any delay or failure of payment of the whole invoice of the supply.
- 10) **WARRANTY.** Sati S.p.A. shall repair or replace free of charge those parts which Sati S.p.A. recognizes as faulty. Said goods shall be returned to Sati S.p.A. free of any charge (delivered duty paid). The warranty does not apply if the goods returned as faulty had been repaired or modified by the buyer. Reworking of defective parts by the buyer will be recognized only if authorized by Sati S.p.A. upon approval of a cost estimate. Sati S.p.A. does not take any responsibility nor recognizes any compensation for possible damages due to the use of its products, even if they are defective.
- 11) **RESPONSIBILITY.** Sati S.p.A. does not take any responsibility nor recognizes any compensation for possible damages due to the use of its products, even if they are defective. Sati S.p.A. declines any responsibility for the execution, according to customer's drawing, of parts subject to patent protection.
- 12) **RETURN MATERIAL.** All returns are to be previously agreed with our Sales Department and the goods must not have been machined or processed by the Customer; on the contrary, returns will be sent back at Customer's charge. Items to be returned must be secured with proper packaging to prevent any damage in transit. Packages showing any evidence of having been tampered with or non-integral ones, will not be accepted. Return notes must contain our shipping document and invoice data. In case of returns due to reasons other than quality defects, differences between ordered and delivered products, or shipping mistakes, Sati S.p.A. reserves the right to debit the Customer the 15% of the value of returned goods to cover handling and stocking costs and these returns have to be carriage paid.
- 13) **APPLICABLE LAW.** Any relationship arising hereunder shall be exclusively governed by, and construed in accordance with, the Italian Law.
- 14) **COURT HAVING JURISDICTION.** All disputes concerning the execution, interpretation or termination of any relationship arising out of, regulated by, or somehow related to the terms of these general conditions, will be exclusively submitted to the judgement of the Law Court of Bologna, except if Sati S.p.A. agrees to submit them to the judgement of the Court having jurisdiction in the Customer's registered office.



## Allgemeine Verkaufsbedingungen

- 1) **AUFTRÄGE.** Für den Verkauf eigener Waren erkennt Sati S.p.A. ausschließlich schriftliche Aufträge. Wir fordern sie auf, in unserem Katalog nachzuschlagen, unsere Artikelnummer zu wählen, und die Aufträge per Fax oder E-mail zu schicken. Nachdem die Bearbeitung oder die Verpackung der Ware angefangen ist, werden sowohl Storno oder Senkungen der Bestellungen nicht akzeptiert. Einzige Ausnahme ist ein Abkommen mit der Verkaufsabteilung. Die Menge der gelieferten Teile nach Kundenzeichnung können  $\pm 5\%$  im Bezug auf die ursprünglich bestellte Menge schwanken. Es werden daher die gelieferten Teile berechnet.
- 2) **PREISE.** Die Preise werden auf der Angebotesphase vereinbart oder beziehen sich auf der allgemeinen Preisliste. Sati S.p.A. vorbehaltet sich, im Fall von verwandelten Markt- und Produktionsbedingungen, die Möglichkeit ihre eigene Preise zu ändern.
- 3) **ABTRETUNGSVERBOT.** Die Abtretung von Pflichten und Rechten an Dritte ist ohne Zustimmung der Firma Sati ausgeschlossen.
- 4) **ZAHLUNGSFRISTEN UND BEDINGUNGEN.** Zahlungsfristen und Bedingungen müssen vorher mit unserer Verkaufsabteilung vereinbart werden. Abrundungen und Betragsabzüge sind ohne vorherige Zustimmung ausgeschlossen. Zahlungsunfähigkeit und Überschreitung der Zahlungsfristen lassen Kosten und Verzugszinsen zu den Maximalterminen, die von dem italienischen Gesetz vorgesehen sind, steigern. Die Kommissionen der ausländischen Bank in Bezug auf die Zahlungen sind zu Lasten des Kunden.
- 5) **EIGENTUMSVORBEHALT.** Bis zur vollständigen Zahlung der Rechnung - Nebenkosten und Interessen eingeschlossen - versteht sich die verkaufte Ware unser Eigentum. Keine Ausstellung oder partielle Erneuerung von Wechseln kann als Löschung oder endgültige Zahlung der Schulden betrachtet werden. Die Ausstellung von Wechseln kann nicht den Eigentumsvorbehalt beeinträchtigen. Trotzdem wird die Gefahr des Verlusts, des Vergehens oder der Beschädigung im Rahmen der Lieferung zu dem Kunde übertragen, nach Maßgabe von Artikeln 6 und 8 dieser Bedingungen.
- 6) **LIEFERFRISTEN.** Lieferfristen werden im Rahmen der Auftragsbestätigung vereinbart. Im Fall von Schwierigkeiten, die in der Versorgung von Materialien oder auf Grund höheren Gewalt entstehen könnten, können die Lieferfristen auch zur Schwankungen -ohne dass die Gültigkeit des Auftrags beeinträchtigt wird- unterworfen sein. Für die nach Kundenzeichnung gefertigte Ware, ist der Kunde zur Warenannahme verpflichtet. Sati S.p.A. ist nicht für Schaden verantwortlich, die von einer Senkung, Nichtherstellung oder Lieferungsverzug der Ware verursacht werden.
- 7) **VERPACKUNG.** Sati S.p.A. rechnet die Verpackung eigener Produkte zum Kostenpreis an.
- 8) **TRANSPORT.** Transportbedingungen werden zwischen Sati S.p.A. und dem Kunden vereinbart. Transport erfolgt stets auf Gefahr des Kunden, außer Verantwortlichkeit des Trägers im Sinne des Artikels 1963 des italienischen Gesetzes.
- 9) **MÄNGELRÜGE.** Eventuelle Mängelrüge die gelieferte Ware betreffend müssen schriftlich innerhalb 20 Arbeitstagen ab Erhalt der Ware angezeigt werden. Entscheidungen über mangelhaften Produkte, Rücklieferungen oder eventuelle Belastungen gelten nur nach ausdrücklicher Vereinbarung zwischen Sati S.p.A. und dem Kunden. Sati S.p.A. akzeptiert keine vom Kunden getragenen Reparaturkosten, wenn nicht vorher schriftlich genehmigt. Die Anwesenheit in einer Lieferung von beanstandeten Material rechtfertigt keine Verspätung oder Nichtzahlung der Rechnung.
- 10) **GARANTIE.** Sati S.p.A. verpflichtet sich, jene Teile kostenlos zu reparieren oder zu ersetzen, die Sati S.p.A. als defekt anerkennt. Die beanstandete Ware muss der Firma Sati S.p.A. kostenlos (geliefert verzollt) zugestellt werden. Die Garantie verfällt, wenn die als defekt zurückgegebenen Teile vom Käufer repariert oder bearbeitet wurden. Die vom Käufer durchgeführten Reparaturen von defekten Teilen gelten als anerkannt, nur wenn sie von Sati S.p.A. nach Prüfung eines Kostenvoranschlags genehmigt wurden. Sati S.p.A. übernimmt weder Haftung noch Kosten für Schäden, die sich bei der Verwendung ihrer Produkte ereignen können, auch dann nicht wenn ein Fabrikationsfehler vorhanden ist.
- 11) **HAFTUNG.** Sati S.p.A. übernimmt weder Haftung noch Kosten für Schäden, die sich bei der Verwendung ihrer Produkte ereignen können, auch dann nicht wenn ein Fabrikationsfehler vorhanden ist. Sati S.p.A. lehnt jegliche Verantwortung bei der Herstellung nach Kundenzeichnung von Teilen ab, die mit eventuellen patentrechtlichen Ansprüchen belegt sind.
- 12) **RETOURWARE.** Die Bedingungen für die Retourware, die von dem Kunden nicht bearbeitet oder behandelt werden muss, sind vorher mit unserem inneren Personal zu vereinbaren; sollte dieses Verfahren nicht berücksichtigt werden, wird die Ware zu Lasten des Kunden wieder zurückgeschickt. Um Schaden zu vermeiden muss die Retourware geeignet verpackt werden. Beschädigte Teile werden nicht akzeptiert. In den Ersatzlieferscheine müssen die ursprünglichen Rechnung und Lieferschein erwähnt werden. Sollte die Retourlieferung - die von uns auf jedem Fall genehmigt werden muss - von einer unterlaufenen Bestellfehler abhängig sein, ist Sati S.p.A. berechtigt, 15% des Werts der Retourware, wegen Lagerungskosten dem Kunden zu belasten und die Rückgabe muss frei unserem Haus erfolgen.
- 13) **GÜLTIGES GESETZ.** Für jede Beziehung, ist ausschließlich das italienische Gesetz gültig.
- 14) **GERICHTSSTAND.** Im Fall von Streitfragen auf Löschung und Aufführung Gebiet von jeder Beziehung, die von diesen Bedingungen entsteht oder geregelt wird, ist nur der Gerichtsstand von Bologna zuständig, außer dem Fall, wo Sati S.p.A. entscheidet den Kunden zusammenzukommen, bei dem Gerichtsstand der Stadt wo der Kunde hat seinen eigenen Sitz.

## Conditions générales de vente

- 1) **COMMANDES.** Sati S.p.A. accepte uniquement des commandes par écrit pour la vente de ses articles, Nous vous invitons à consulter notre catalogue en signalant nos codes des produits et à envoyer les commandes par fax ou par e-mail. Une fois la fabrication ou l'emballage des pièces est commencé, nous n'acceptons aucune annulation ni réduction de commande - sauf en cas d'accords différents avec notre service commercial. Pour les produits réalisés selon le plan du client, il peut y avoir une différence dans le nombre de pièces livrées au client de  $\pm 5\%$  par rapport à la quantité commandée ; par conséquent, la facturation sera adaptée à la quantité envoyée.
- 2) **PRIX.** Les prix sont établis au moment de l'offre ou se réfèrent au tarif général. Sati S.p.A. peut modifier ses cotations en tout moment, si cela s'avère nécessaire à cause d'un changement des conditions du marché ou de production.
- 3) **INTERDICTION DE CESSION.** Les obligations et les droits du Client ne peuvent pas être cédés à des tiers sans une autorisation préalable de la part de Sati S.p.A.
- 4) **TERMES DE PAIEMENT.** Les termes de paiement doivent être établis préalablement avec notre service commercial. Il est interdit d'opérer des arrondissements ou des retenues sur les montants dus, sans avoir obtenu l'autorisation préalable de la part de notre service de vente. En cas d'insolvabilité de récépissés sur banque ou pour tout paiement en retard, le Client devra payer des frais et des intérêts moratoires jusqu'au maximum prévu par la loi italienne. Les commissions de la banque étrangère concernant les paiements sont à la charge de l'ordinaire.
- 5) **RÉSERVE DE PROPRIÉTÉ.** La marchandise est vendue avec réserve de propriété, jusqu'à quand le prix ne soit complètement payé, y compris les intérêts et les accessoires. La remise de traites et leurs renouvellements éventuels, même partiels, de la part du Client, ne peut pas être considérée en tant qu'extinction ni novation ni paiement définitif du prix, sinon à bonne fin des traites-mêmes ; de même, la remise de traites ne peut pas compromettre la réserve de propriété. Malgré tout ce qui précède, tout risque de perte, détérioration ou endommagement est transféré au Client au moment de la livraison conformément aux art. 6 et 8 des présentes conditions.
- 6) **DÉLAIS DE LIVRAISON.** Les délais de livraison des fournitures doivent être concordés pour chaque commande. En cas de difficulté d'approvisionnement des matériaux, de production ou en tout cas de force majeure, les termes de livraison peuvent être modifiés sans compromettre la validité de la commande. En cas de produits réalisés selon le plan du Client, ce dernier est obligé à retirer le matériel commandé. De toute façon, Sati S.p.A. n'a aucune responsabilité pour tout préjudice dû à une production réduite ou manquée, y compris les dommages indirects et dérivant du retard dans la livraison des produits commandés.
- 7) **EMBALLAGE.** Sati S.p.A. facture l'emballage au prix de revient.
- 8) **TRANSPORT.** Les conditions de transport doivent être établies entre Sati S.p.A. et le Client. Les marchandises voyagent aux risques et périls du Client, sauf les responsabilités du transporteur, conformément à l'art. 1693 du code civil italien.
- 9) **RÉCLAMATIONS.** Les réclamations et les litiges éventuels concernant les marchandises livrées sont à signaler par écrit dans un délai de 20 jours dès la livraison. Le traitement de chaque pièce, reconnue défectueuse - y compris les charges éventuelles, - et la décision concernant la fourniture dans son entier, doivent être toujours concordés. En particulier, nous n'acceptons pas de débit concernant les frais de réparation payés directement par le Client, sans autorisation préalable de la part de notre service commercial. S'il y a du matériel contesté dans une fourniture, cela ne justifie aucun retard ou suspension du paiement de la facture concernant la fourniture en question.
- 10) **GARANTIE.** Sati S.p.A. s'engage à réparer ou remplacer gratuitement toute pièce reconnue défectueuse. La marchandise qui fait l'objet de la réclamation doit être rendue à notre siège franco de tous frais. La garantie ne sera pas applicable aux pièces qui ont été usinées ou altérées par le client. Les réparations effectuées par le client, ainsi que les coûts qui s'ensuivent, seront reconnues seulement si autorisée préalablement par Sati S.p.A. Sati S.p.A. décline toute responsabilité et refuse toute indemnisation pour les dommages résultant de l'utilisation de ses produits, même si défectueux.
- 11) **RESPONSABILITÉ.** Sati décline toute responsabilité et refuse toute indemnisation pour les dommages résultant de l'utilisation de ses produits, même si défectueux. Sati S.p.A. décline toute responsabilité pour l'exécution de pièces suivant les plans des clients, qui soient éventuellement protégés par un brevet.
- 12) **MARCHANDISES RETOURNÉES.** Les conditions pour retourner les marchandises, qui ne doivent absolument être usinées ou traitées par le Client, sont à établir préalablement avec notre service commercial; dans le cas contraire, toute marchandise retournée sera renvoyée à l'expéditeur, et les frais de transport seront à sa charge. Les marchandises retournées doivent être dûment emballées pour éviter tout endommagement des pièces. Nous n'accepterons aucun colis endommagé ou non complètement intègres. Il faut indiquer les coordonnées de notre document de transport et de la facture concernant la fourniture dans les bordereaux de retour des marchandises. Pour ce qui concerne matériel retourné pour des raisons différentes par rapport à : défauts de qualité, différences par rapport à ce qui avait été commandé, notre erreur d'expédition, Sati S.p.A. se réserve de débiter 15% de la valeur des marchandises retournées pour couvrir les coûts de manutention et de stockage des marchandises et l'expédition doit être en port payé.
- 13) **LOI APPLICABLE.** Toute relation dérivant, réglementée ou, de toute façon, liée à ces conditions générales, sera soumise à la loi italienne.
- 14) **TRIBUNAL COMPÉTENT.** Pour tout litige concernant la mise en oeuvre, l'interprétation ou la résiliation de toute relation dérivant, réglementée ou, de toute façon, liée à ces conditions générales, le Tribunal de Bologne sera compétent, sauf la faculté de Sati S.p.A. de poursuivre le Client dans le tribunal compétent au niveau du territoire où le Client à son siège légal.



[www.satispa.com](http://www.satispa.com)



**Sati S.p.A. con Unico Socio** | Via 2 Agosto 1980, 5/A  
Zona Ind. via Lunga 40056 Crespellano (BO) | Italy  
Comm.le Italia: tel. +39 051 6721611 | fax +39 051 969645  
Export dpt: tel. +39 051 6721625 | fax +39 051 969646  
[www.satispa.com](http://www.satispa.com) | [info@satispa.com](mailto:info@satispa.com)



ISO 9001 Cert. 0794